

METRAHIT Iso and METRAHIT Coil

TRMS Multimeter with Insulation and Interturn Short-circuit Measurement (METRAHIT Coil only)

3-349-416-03
20/9.22



Standard Equipment METRAHIT ISO

- 1 Multimeter for isolation measurement
- 1 Protective rubber cover
- 1 KS17-2 cable set
- 1 DAkkS calibration certificate with calibration report
- 2 Batteries, 1.5 V, type AA, installed
- 1 Condensed operating instructions *

Standard Equipment METRAHIT COIL

- 1 Insulation multimeter
- 1 Protective rubber cover
- 1 KS17-2 cable set
- 1 DAkkS calibration certificate
- 2 Batteries 1.5 V, type AA, installed
- 1 **COIL TEST ADAPTER** for interturn short-circuit measurement
- 1 Condensed operating instructions *

* Detailed operating instructions are available for download on the Internet at www.gossenmetrawatt.com

Function	METRAHIT Iso	METRAHIT COIL
V AC+DC TRMS (Ri = 1 MΩ)	•	•
V AC / Hz TRMS (Ri ≥ 9 MΩ)	$\overline{1\text{kHz}}$ Filter	$\overline{1\text{kHz}}$ Filter
V AC+DC TRMS (Ri ≥ 9 MΩ)	•	•
V DC (Ri ≥ 9 MΩ)	•	•
Hz (V AC)	... 300 kHz	... 300 kHz
Bandwidth V AC	15 Hz ... 10 kHz	15 Hz ... 10 kHz
A AC / Hz TRMS	300 μA	300 μA
A AC+DC TRMS	3/30/300 mA	3/30/300 mA
A DC	3 A / 10 A	3 A / 10 A
Fuse	10 A/1000 V	10 A/1000 V
Transformation factor $\succ C$	mV/A, mA/A	mV/A, mA/A
Hz (A AC)	... 30 kHz	... 30 kHz
Insulation Resistance $M_{COILISO}$	adjustable test voltage	adjustable test voltage
Interturn short-circuit measurement M_{COIL}	—	•
Duty cycle measurement %	—	•
Resistance Ω	•	•
Continuity \square)	•	•
Diode ... 5,1 V $\rightarrow $	•	•
Temperature TC (K)	•	•
Temperature RTD	•	•
Capacitance $\rightarrow $	•	•
MIN/MAX / data hold	•	•
4 MBit memory ¹⁾	•	•
IR Interface	•	•
Power pack adapter socket	•	•
Protection	IP54	•
Measuring category	1000 V CAT II, 600 V CAT III	IP54

¹⁾ For 15,000 measured values, sampling rate adjustable from 0.1 second to 9 hours

Accessories (sensors, plug inserts, adapters, consumable materials)

The accessories available for your instrument are checked for compliance with currently valid safety regulations at regular intervals, and are amended as required for new applications. Currently up-to-date accessories which are suitable for your measuring instrument are listed at the following web address along with photo, order number, description and, depending upon the scope of the respective accessory, data sheet and operating instructions:
www.gossenmetrawatt.com

See also chapter 10 on page 72.

Product Support

Technical Queries
(use, operation, software registration and software enabling for METRAwin 10)

If required please contact:

Gossen Metrawatt GmbH

Hotline Produktsupport

+49 911 8602-0

info@gossenmetrawatt.com / support@gossenmetrawatt.com

Monday – Thursday: 8 a.m. to 4 p.m.

Friday: 8 a.m. to 2 p.m.

Training

Training in Nürnberg, on-site training at customer facilities
(scheduling, prices, registration, travel, accommodation)

If required please contact:

Gossen Metrawatt GmbH

Training Division

Phone +49 911 8602-935

Fax +49 911 8602-724

E-Mail training@gossenmetrawatt.com

Recalibration Service

We **calibrate** and **recalibrate** all instruments supplied by Gossen Metrawatt GmbH, as well as other manufacturers, at our service center, for example after one year within the framework of your test equipment monitoring program, as well as prior to use etc. and offer you test equipment management free of charge.

See also chapter 9.6 on page 71.

Repair and Replacement Parts Service Calibration Center* and Rental Instrument Service

If required please contact:

GMC-I Service GmbH
Service Center

Beuthener Straße 41
90471 Nürnberg, Germany

Phone: +49 911 817718-0

Fax: +49 911 817718-253

E-mail service@gossenmetrawatt.com

www.gmci-service.com

This address is only valid in Germany. Please contact our representatives or subsidiaries for service in other countries.

* **DAkkS Calibration Laboratory for Measured Electrical Quantities** **D-K-15080-01-01 accredited per DIN EN ISO/IEC 17025**

Accredited quantities: direct voltage, direct current value, direct current resistance, alternating voltage, alternating current value, AC active power, AC apparent power, DC power, capacitance, frequency, temperature

Competent Partner

Gossen Metrawatt GmbH is certified in accordance with DIN EN ISO 9001.

Our DAkkS calibration laboratory is accredited by the Deutsche Akkreditierungsstelle GmbH (National accreditation body for the Federal Republic of Germany) in accordance with DIN EN ISO/IEC 17025 under registration number D-K-15080-01-01.

We offer a complete range of expertise in the field of metrology: from **test reports** and **factory calibration certificates**, right on up to **DAkkS calibration certificates**.

Our spectrum of offerings is rounded out with free **test equipment management**.

As a full service calibration lab, we can calibrate instruments from other manufacturers as well.

Table of Contents

Contents	Page	Contents	Page
1 Safety Features and Precautions	8	5 Measurements	26
1.1 Use for Intended Purpose	10	5.1 Voltage Measurement	26
1.2 Meanings of Danger Symbols	10	5.1.1 Direct and Pulsating Voltage Measurement, V DC and V (DC+AC)	27
1.3 Meanings of Acoustic Warning Signals	10	5.1.2 Alternating Voltage and Frequency Measurement V AC and Hz with Selectable Low-Pass Filter	28
2 Operating Overview – Connections, Keys, Rotary Switch, Symbols 12		5.2 Resistance Measurement, Ω	32
3 Initial Start-Up	16	5.3 Temperature Measurement: Temp RTD and Temp TC	33
3.1 Batteries	16	5.3.1 Measurement with Resistance Thermometers	33
3.2 Activation	16	5.3.2 Measurement with Thermocouples, Temp TC	35
3.3 Setting the Operating Parameters	16	5.4 Continuity Test	36
3.4 Switching the Instrument Off	17	5.5 Diode Testing with Constant Current of 1 mA	37
4 Control Functions	18	5.6 Capacitance Measurement	38
4.1 Selecting Measuring Functions and Measuring Ranges	18	5.7 Insulation Resistance Measurement – $M\Omega_{@UISO}$	39
4.1.1 Automatic Range Selection	18	5.7.1 Preparing for Measurement	39
4.1.2 Manual Measuring Range Selection	18	5.7.2 Performing the Insulation Measurement	40
4.1.3 Quick Measurements	19	5.7.3 Ending the Measurement and Discharging	41
4.2 Zero Offset / Relative Measurements	19	5.8 Interturn Short-circuit Measurement – Function COIL/ $M\Omega_{@UISO}$	42
4.3 Display (LCD)	20	5.8.1 Preparing the Measurement	42
4.3.1 Digital Display	20	5.8.2 Performing Interturn Short-circuit Measurement	43
4.3.2 Analog Display	20	5.8.3 Ending the Measurement and Discharging	45
4.4 Measured Value Storage: DATA (auto-hold / compare)	21	5.9 Current Measurement	46
4.4.1 Function DATA during insulation measurement *	22	5.9.1 Direct and Pulsating Current Measurement, Direct Connection, A DC and A (DC+AC)	47
4.4.2 Saving Minimum and Maximum Values – MIN/MAX Function	23	5.9.2 Alternating Current and Frequency Measurement, Direct Connection, A AC and Hz	48
4.5 Measurement Data Recording	24	5.9.3 Direct and Pulsating Current Measurement with Clip-On Current Sensor A DC and A (DC+AC)	49
		5.9.4 Alternating Current Measurement with Clip-On Current Sensor, A AC and Hz	50

Contents	Page	Contents	Page
5.9.5 Alternating Current Measurement with A AC and Hz Clip-On Current Transformer	51	10 Accessories	72
6 Device and Measuring Parameters	52	10.1 General	72
6.1 Paths to the Various Parameters	53	10.2 Technical Data for Measurement Cables (scope of delivery: KS17-2 safety cable set)	72
6.2 List of All Parameters	53	10.3 Power Pack NA X-TRA (not included)	72
6.3 Querying Parameters – InFo Menu (as moving letters)	54	10.4 Interface Accessories (not included)	73
6.4 Entering Parameters – SETUP Menu	55	11 Index	74
6.5 Default Settings	57		
7 Interface Operation	58		
7.1 Activating the Interface	58		
7.2 Configuring Interface Parameters	59		
8 Technical Data	60		
9 Maintenance and Recalibration	68		
9.1 Displays – Error Messages	68		
9.2 Batteries	68		
9.3 Fuses	69		
9.4 Housing Maintenance	70		
9.5 Return and Environmentally Sound Disposal	70		
9.6 Recalibration	71		
9.7 Manufacturer’s Guarantee	71		

1 Safety Features and Precautions

You have selected an instrument which provides you with a high level of safety.

This instrument fulfills the requirements of the applicable European guidelines and national regulations. This is confirmed by means of the CE mark. A corresponding declaration of conformity can be

requested from Gossen Metrawatt GmbH.

The TRMS digital multimeter has been manufactured and tested in accordance with the following safety regulations:

IEC 61010-1:2010/DIN EN 61010-1:2011/VDE 0411-1:2011.

When used for its intended purpose (see page 10), safety of the operator, as well as that of the instrument, is assured. Their safety is however not guaranteed, if the instrument is used improperly or handled carelessly.

In order to maintain flawless technical safety conditions, and to assure safe use, it is imperative that you read the operating instructions thoroughly and carefully before placing your instrument into service, and that you follow all instructions contained therein.

The multimeter is equipped with an automatic socket blocking mechanism for your safety, and in order to safeguard your instrument. This mechanism is linked to the rotary switch and only allows access to those jacks which are actually required for the selected function. It also prevents the user from turning the rotary switch to impermissible functions after the measurement cables have already been plugged in.

Measuring Categories and their Significance per IEC 61010-1

CAT	Definition
I	Measurements in electrical circuits which are not directly connected to the mains: <i>e.g. electrical systems in motor vehicles and aircraft, batteries etc.</i>
II	Measurements in electrical circuits which are electrically connected to the low-voltage mains: <i>via plug, e.g. in household, office and laboratory applications</i>
III	Measurements in building installations: stationary consumers, distributor terminals, devices connected permanently to the distributor

The measuring category and the maximum rated voltage which are printed on the device apply to your measuring instrument, e.g. 600 V CAT III or 1000 V CAT II.

For the application of measuring cables see page 72.

Observe the following safety precautions:

- The multimeter may not be used in **potentially explosive atmospheres**.
- The multimeter may only be operated by persons who are capable of recognizing **contact hazards** and taking the appropriate safety precautions. Contact hazards according to the standards exist anywhere, where voltages of greater than 33 V RMS or 70 V DC may occur. Avoid working alone when taking measurements which involve contact hazards. Be certain that a second person is present.
- **Maximum allowable voltage** between the voltage measuring sockets or all connector sockets and ground is 1000 V for measuring category II, and 600 V for measuring category III.
- **Weak battery**
If the “weak battery” icon appears in the battery level indicator, it’s no longer permissible to perform safety-relevant measurements. Furthermore, compliance with the listed specifications is no longer assured in the case of a weak battery.

- Be prepared for the occurrence of unexpected voltages at devices under test (e.g. defective devices). For example, capacitors may be dangerously charged.
- Make certain that the measurement cables are in flawless condition, e.g. no damage to insulation, no interruptions in cables or plugs etc.
- No measurements may be made with this instrument in electrical circuits with corona discharge (high-voltage).
- Special care is required when measurements are made in HF electrical circuits. Dangerous pulsating voltages may be present.
- Measurements under moist ambient conditions are not permitted.
- Be absolutely certain that the measuring ranges are not overloaded beyond their allowable capacities. Limit values are included in chapter 8; "Technical Data" in the table entitled "Measuring Functions and Measuring Ranges" in the "Overload Capacity" column.
- **The multimeter may only be operated with installed batteries or rechargeable batteries. Dangerous currents and voltages are otherwise not indicated, and the instrument may be damaged.**
- The instrument may not be operated if the fuse cover or the battery compartment lid has been removed, or if its housing is open.
- The input for the current measuring range is equipped with a fuse link.
Maximum permissible voltage for the measuring circuit (= rated voltage of the fuse) is 1000 V AC/DC.
Use specified fuses only (see page 65)! The fuse must have a **breaking capacity of at least 30 kA.**

Opening of Equipment / Repair

The equipment may be opened only by authorized service personnel to ensure the safe and correct operation of the equipment and to keep the warranty valid.

Even original spare parts may be installed only by authorized service personnel.

In case the equipment was opened by unauthorized personnel, no warranty regarding personal safety, measurement accuracy, conformity with applicable safety measures or any consequential damage is granted by the manufacturer.

Repair and Parts Replacement by Authorized Service Personnel

When the instrument is opened, voltage conducting parts may be exposed. The instrument must be disconnected from the measuring circuit before the performance of repairs or the replacement of parts. If repair of a live open instrument is required, it may only be carried out by trained personnel who are familiar with the dangers involved.

Defects and Extraordinary Strains

If it may be assumed that the instrument can no longer be operated safely, it must be removed from service and secured against unintentional use.

Safe operation can no longer be relied upon:

- If the device demonstrates visible damage,
- If the instrument no longer functions, or if malfunctioning occurs,
- After long periods of storage under unfavorable conditions, e.g. humidity, dust or extreme temperature (see "Ambient Conditions" on page 64).

1.1 Use for Intended Purpose

- The respective multimeter is a portable device which can be held in the hand during the performance of measurements.
- Only those types of measurements described in chapter 5 may be performed with the measuring instrument.
- The measuring instrument, including measurement cables and plug-on test probes, may only be utilized within the specified measuring category (see page 65 and the table on page 8 regarding significance).
- Overload limits may not be exceeded. See technical data on page 60 for overload values and overload limits.
- Measurements may only be performed under the specified ambient conditions. See page 64 regarding operating temperature range and relative humidity.
- The measuring instrument may only be used in accordance with the specified degree of protection (IP code) (see page 66).

1.2 Meanings of Danger Symbols



Warning concerning a point of danger
(attention: observe documentation!)



Warning concerning dangerous voltage at the measurement input: $U > 15 \text{ V AC}$ or $U > 25 \text{ V DC}$

1.3 Meanings of Acoustic Warning Signals

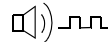

Voltage warning: $> 1000 \text{ V}$ (intermittent acoustic signal)

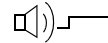

Current warning: $> 11 \text{ A}$ (continuous acoustic signal)

2 Operating Overview – Connections, Keys, Rotary Switch, Symbols





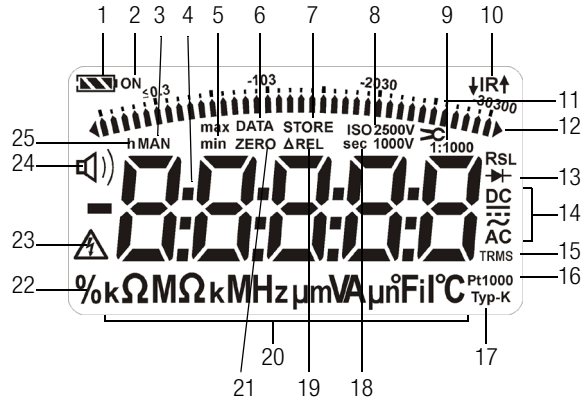

- 1 Display (LCD) (see page 13 for significance of symbols)
 - 2 **MAN / AUTO** shift key for manual/automatic measuring range selection
 △ Increase parameter values
“Operating Mode” menu: Selection of individual menu entries against the direction of flow
 - 3 **ON / OFF | LIGHT** key for switching device and display illumination on and off
 - 4 **FUNC | ENTER** multifunction key
“Operating Mode” menu: Acknowledge entry (ENTER)
Uiso ON / OFF Insulation resistance measurement
 Key for switching insulation resistance measurement on and off
 - 5 ▷ Increase measuring range or move decimal point to the right (MAN function)
 - 6 **Rotary switch** for measuring functions (see page 14 for significance of symbols)
 - 7 DAKS calibration mark
 - 8 Connector socket for ground / connected to ground
 - 9 Connector socket for current measurement with automatic blocking
 - 10 Connector socket for voltage, resistance, temperature, diode and capacitance measurement with automatic blocking
 - 11 **DATA / MIN / MAX**
 Key for freezing, comparing, deleting the measured value, and for Min/Max function
 ▽ Decrease values
“Operating Mode” menu: Select individual menu entries in flow direction
 - 12 **MEASURE I SETUP** Key for switching between measuring and menu functions
 - 13 **ZERO | ESC**
 Key for zero balancing
“Operating Mode” menu: Exit menu level and return to a higher level, exit parameters entry function without saving
- METRAHIT COIL only – Function COIL:**
Ucoil ON / OFF Interturn short-circuit measurement as long as key is being pressed, see chapter 5.8.
- 14 <◁ Decrease measuring range or move decimal point to the left (MAN function)
 - 15 Power pack connector jack
 - 16 Infrared interface

Symbols used in the Digital Display



Battery level indicator

-  Battery full
-  Battery OK
-  Battery weak
-  Battery (almost) dead, $U < 2.0\text{ V}$











Interface indicator

-  Data transmission ↓ to / ↑ from the multimeter is active
- IR** IR interface in standby mode (ready to receive starting commands)

- 1 Battery level indicator
- 2 ON: continuous operation (automatic shutdown deactivated)
- 3 MAN: manual measuring range selection active
- 4 Digital display with decimal point and polarity display
- 5 max/min: Min/Max value storage
- 6 DATA: display memory, “freeze measured value”
- 7 STORE: memory mode active
- 8 ISO: insulation resistance measurement active / selected test voltage
- 9 1: x current clip factor (transformation ratio)
- 10 IR: infrared interface display
- 11 Scale for analog display
- 12 Pointer for analog display (bar graph – pointer)
triangle appears: indicates overranging
- 13 Diode measurement selected
- 14 Selected type of current
- 15 TRMS measurement
- 16 Pt100(0): selected platinum resistance thermometer with automatic recognition of Pt100/Pt1000
- 17 Type K: temperature measurement with type K (NiCr-Ni) thermocouple
- 18 sec (seconds): unit of time
- 19 ΔREL: relative measurement with reference to offset
- 20 Unit of measure
- 21 ZERO: zero balancing active
- 22 Duty Cycle Measurement
(this function only available with customer-specific variant)
- 23 Warning regarding dangerous voltage: $U > 15\text{ V AC}$ or $U > 25\text{ V DC}$**
- 24  Continuity test with acoustic signal active
- 25 h (hours): unit of time

Operating Overview – Connections, Keys, Rotary Switch, Symbols

Symbols used for Rotary Switch positions

Switch	FUNC	Display	Measuring Function	Additional Function clip-on (by menu SET ⇒ CLIP 1:1/10/100/1000)
 $1M\Omega$	0/2	V DC AC TRMS	Pulsating voltage, TRMS DC + AC, 15 Hz ... 500 Hz <i>only for detection of interference voltage!</i>	
$M\Omega_{ISO}@UISO$	1	UISO / k Ω / M Ω	Insulation resistance measurement	
$COIL/M\Omega@UISO$	0	UCOIL [μ s]	Interturn short-circuit measurement with METRAHIT COIL	
$V\sim$	0/5	V~ AC TRMS	Alternating voltage, AC TRMS, full bandwidth	 Clip-on AC (V): clip-on current sensor
Hz (V)	1	Hz ~ AC	Voltage frequency, full bandwidth	 Clip-on Hz (V): clip-on current sensor
%	2	%	Duty Cycle Measurement with METRAHIT COIL	
$V\sim \overline{1kHz}$	3	V Fil ~ AC TRMS	Voltage frequency, with low pass filter (1 kHz)	
Hz (V) $\overline{1kHz}$	4	Hz Fil ~ AC	Voltage frequency, with low pass filter (1 kHz)	
$V\equiv$	0/2	$V\equiv$ DC	Direct voltage	 Clip-on DC (V): clip-on current sensor
$V\sim\equiv$	1	$V\sim\equiv$ DC AC TRMS	Pulsating voltage, TRMS ($V_{ACDC} = \sqrt{V_{AC}^2 + V_{DC}^2}$)	 Clip-on DC + AC (V): clip-on current sensor
Ω	0	Ω	(DC) resistance	
	0/2	 Ω	Continuity test with acoustic signal	
	1	 $V\equiv$ DC	Diode voltage where I is constant	
Temp RTD	0	°C Pt 100/1000	Temperature with Pt 100 / Pt 1000 resistance thermometer	
Temp TC	1	°C Typ-K	Temperature with thermoelement type K	
$\overline{ }$	0	nF, μ F	Capacitance	
$A\equiv$	0/2	$A\equiv$ DC	Direct current value	
$A\sim\equiv$	1	$A\sim\equiv$ DC AC TRMS	Pulsating current amperage, AC DC TRMS	
$A\sim$	0/2	$A\sim$ AC TRMS	Alternating current amperage, AC TRMS	 Clip-on AC (A): clip-on current transformer
Hz (A)	1	Hz ~ AC	Current frequency	 Clip-on Hz (A): clip-on current transformer

User Interface Symbols in the Following Chapters

- ▷ ... ▷ Scroll through main menu
- ▽ ... ▽ Scroll through submenu
- ◁ ▷ Select decimal point
- △ ▽ Increase/decrease value
- b nE* Submenu/parameter (7-segment font)
- Info** Main menu (7-segment font, boldface)

Symbols on the Device

 Warning concerning a point of danger (attention: observe documentation!)

 Ground

CAT II / III Measuring category II or III device, see also “Measuring Categories and their Significance per IEC 61010-1” on page 8.

 Continuous, doubled or reinforced insulation

CE Indicates EC conformity

▲ IR ▼ Position of the infrared interface, window on the top of the instrument



Position of the power pack adapter socket, see also chapter 3.1.

 Fuse for current measuring ranges (see chapter 9.3)

 The device may not be disposed of with the trash. Further information regarding the WEEE mark can be accessed on the Internet at www.gossenmetrawatt.com under the search term WEEE (see also chapter 9.5).

Calibration mark (blue seal):

XY123	Serial number
D-K-	German Accrediation Body GmbH – Calibration lab
15080-01-01	Registration number
2012-07	Date of calibraion (year – month)

See also “Recalibration” on page 71.

3 Initial Start-Up

3.1 Batteries

Be certain to refer to chapter 9.2 regarding correct battery installation!

Momentary battery voltage can be queried in the “Info” menu (see chapter 6.3).



Attention!

Disconnect the instrument from the measuring circuit before opening the battery compartment lid in order to replace the batteries.

Operation with Power Pack (not included, see chapter 10.3)

Installed batteries are disconnected electronically if the **NA X-TRA** power pack is used, and need not be removed from the instrument. If rechargeable batteries are used, they must be recharged externally.

If the external power supply is switched off, the device is switched to battery operation without interruption.

3.2 Activation

Switching the Instrument On Manually

- ⇨ Press the **ON / OFF | LIGHT** key until the display appears. Power-up is acknowledged with a brief acoustic signal. As long as the key is held depressed, all of the segments at the liquid crystal display (LCD) are illuminated. The LCD is depicted on page 13. The instrument is ready for use as soon as the key is released.

Display Illumination

After the instrument has been switched on, background illumination can be activated by briefly pressing the **ON / OFF | LIGHT** key. Illumination is switched back off by once again pressing the same key, or automatically after approximately 1 minute.

Switching the Instrument On with a PC

The multimeter is switched on after transmission of a data block from the PC, assuming the “*rSLB*” parameter has been set to “*rON*” (see chapter 6.4).

However, we recommend using the power saving mode: “*rOFF*”.



Note

Electrical discharge and high frequency interference may cause incorrect displays to appear, and may disable the measuring sequence.

Disconnect the device from the measuring circuit. Switch the instrument off and back on again in order to reset. If the problem persists, briefly dislodge the battery from the connector contacts (see also chapter 9.2).

3.3 Setting the Operating Parameters

Setting Time and Date

See “*T*”, “*NE*” and “*dALE*” parameters in chapter 6.4.

Display Modes for the Digital Display

Selection can be made from two different display modes (see “*D.d*”, “*SP*” parameter in chapter 6.4).

3.4 Switching the Instrument Off

Switching the Instrument Off Manually

- ⇨ Press the **ON / OFF | LIGHT** key until **OFF** appears at the display. Shutdown is acknowledged with a brief acoustic signal.

Automatic Shutdown

The instrument is switched off automatically if the measured value remains unchanged for a long period of time (maximum measured value fluctuation of approximately 0.8% of the measuring range per minute or 1° C or 1° F per minute), and if none of the keys or the rotary switch have been activated before a selected period of time in minutes has elapsed (see “**APoFF**” parameter on page 53). Shutdown is acknowledged with a brief acoustic signal.

Exceptions include:

Transmission and memory mode operation, continuous operation and whenever a dangerous voltage is applied to the input ($U > 15 \text{ V AC}$ or $U > 25 \text{ V DC}$).

Disabling Automatic Shutdown

The instrument can be set to continuous operation.

- ⇨ Simultaneously press the

 and  keys to this end.

The “Continuous On” function is indicated at by means of the **ON** display to the right of the battery symbol.

The “Continuous On (on)” setting can be cancelled by changing the respective parameter or by switching the instrument off manually.

In this case the parameter will be reset to 10 min (see “APoFF**” on page 56).**

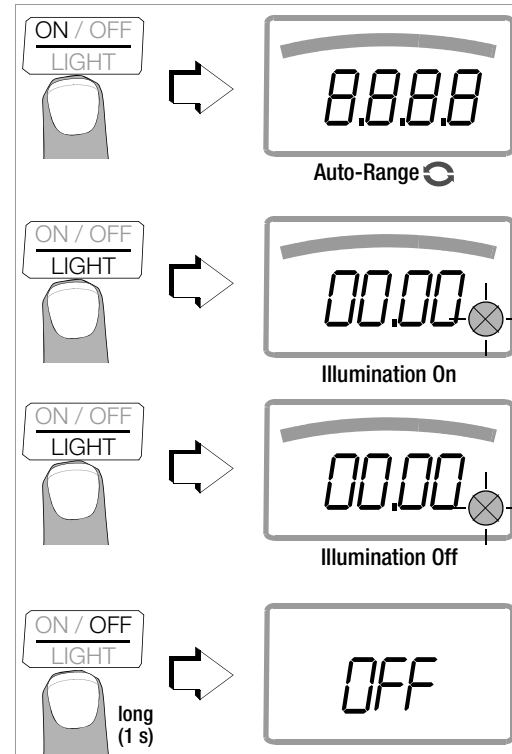

4 Control Functions

4.1 Selecting Measuring Functions and Measuring Ranges

4.1.1 Automatic Range Selection

The multimeter is equipped with auto-ranging for all measuring functions, except for temperature measurement, and diode and continuity testing. Auto-ranging is active as soon as the instrument is switched on. The instrument automatically selects the measuring range which allows for highest possible resolution of the applied quantity. When the instrument is switched to frequency measurement, the previously selected voltage measuring range remains active.

AUTO-Range Function

The multimeter is switched automatically to the next higher range at $\pm(3099 d + 1 d \rightarrow 03 10 d)$, and to the next lower range at $\pm(280 d - 1 d \rightarrow 2799 d)$.

With high resolution the multimeter is switched automatically to the next higher range at $\pm(30999 d + 1 d \rightarrow 03 100 d)$, and to the next lower range at $\pm(2800 d - 1 d \rightarrow 27999 d)$.

4.1.2 Manual Measuring Range Selection

Auto-ranging can be deactivated and measuring ranges can be selected manually in accordance with the following table by pressing the **MAN / AUTO** button.

The desired measuring range can then be selected with the \triangleleft or \triangleright key.

The instrument is automatically returned to range selection when the **MAN / AUTO** key is pressed, the rotary switch is activated or the instrument is switched off and back on again.

Overview: Auto-Ranging and Manual Range Selection

	Function	Display
MAN / AUTO	Manual mode active: utilized measuring range is fixed	MAN
\triangleleft or \triangleright	Range switching sequence for: V: 300 mV* \leftrightarrow 3 V \leftrightarrow 30 V \leftrightarrow 300 V \leftrightarrow 1000 V Hz: 300 Hz \leftrightarrow 3 kHz \leftrightarrow 30 kHz \leftrightarrow 300 kHz (Hz(U)) Ω: 300 Ω \leftrightarrow 3 k Ω \leftrightarrow 30 k Ω \leftrightarrow 300 k Ω \leftrightarrow 3 M Ω \leftrightarrow 30 M Ω A: 300 μ A \leftrightarrow 3 mA \leftrightarrow 30 mA \leftrightarrow 300 mA \leftrightarrow 3 A \leftrightarrow 10 A A χ: See chapter 5.9.3 und chapter 5.9.4 F: 30 nF \leftrightarrow 300 nF \leftrightarrow 3 μ F \leftrightarrow 30 μ F \leftrightarrow 300 μ F MΩ@ISO: 300 k Ω \leftrightarrow 3 M Ω \leftrightarrow 30 M Ω \leftrightarrow 300 M Ω \leftrightarrow 3000 M Ω	MAN
MAN / AUTO	Return to automatic measuring range selection	—

* Via manual measuring range selection only

The multimeter is held in the selected measuring range. If the range limit is exceeded, **OL** appears at the display. You should then switch to the next higher measuring range with the help of the \triangleright key.

4.1.3 Quick Measurements

Measurements performed using a suitable fixed measuring range are executed more quickly than those which utilize automatic range selection. Quick measurement is made possible with the following two functions:

- **Manual measuring range selection**, i.e. selection of the measuring range with the best resolution (see chapter 4.1.2)

or

- With the **DATA function** (see chapter 4.4). In this way, the appropriate measuring range is selected automatically after the first measurement and the second measurement is executed more quickly.

The selected measuring range remains active for the subsequent series of measurements with these two functions.

4.2 Zero Offset / Relative Measurements

Zero balancing or a reference value for relative measurements can be stored to memory depending upon deviation from the zero point:

Deviation from zero – with short-circuited measurement cables for V, Ω , A – with open input for capacitance unit of measure: F	Display
0 to 200 digits	ZERO Δ REL
> 200 to 1500 digits	Δ REL

The relevant reference or correction value is deducted individually for the respective measuring function as an offset from all future measurements and remains in memory until deleted, or until the multimeter is switched off.

Zero balancing and reference value adjustment can be used for auto-ranging, as well as for manual measuring range selection.

Note: Zero balancing is not possible in switch position **M Ω @UIS0**.

Zero Balancing

- Plug the measuring cables into the instrument and connect the free ends to each other, except for capacitance measurement in which case the ends of the cables are not connected to each other.
- Briefly press the **ZERO | ESC** key.
The instrument acknowledges zero balancing with an acoustic signal, and the “ZERO Δ REL” symbol appears at the LCD. The value measured at the moment the key is pressed serves as a reference value.
- Zero balancing can be cleared by once again pressing the **ZERO | ESC** key.

Note

As a result of TRMS measurement, the multimeter displays a residual value of 1 to 10/35 digits with short-circuited measurement cables as the zero point for V AC / I AC or V(AC+DC) / I (AC+DC) measurements (non-linearity of the TRMS converter). This has no influence on specified accuracy above 1% of the measuring range (or 3% in the mV, V(AC+DC) ranges).

Setting the Reference Value

- Plug the measuring cables into the instrument and measure a reference value (max. 1500 digits).

- ⇨ Briefly press the **ZERO | ESC** key.
The instrument acknowledges storage of the reference value with an acoustic signal, and the “ZERO ΔREL” or the “ΔREL” symbol appears at the LCD. The value measured at the moment the key is pressed serves as a reference value.
- ⇨ The reference value can be cleared by once again pressing the **ZERO | ESC** key.

Notes Regarding Relative Measurement

- Relative measurement effects the digital display only. The analog display continues to read out the original measured value.
- In the case of relative measurement, Ω F or AC quantities may also appear as negative values.

4.3 Display (LCD)

4.3.1 Digital Display

Measured Value, Unit of Measure, Type of Current, Polarity

The measured value with decimal and plus or minus sign appears at the digital display. The selected unit of measure and current type are displayed as well. A minus sign appears to the left of the value during the measurement of zero-frequency quantities, if the plus pole of the measured quantity is applied to the “ \perp ” input.

The “ $\overline{0}$, d , SP ” parameter can be used to determine whether leading zeros will be appear or be suppressed at the measured value display (see chapter 6.4).

Overranging

If the upper range limit of 3100 digits is exceeded “ \overline{OL} ” (overload) appears at the display.

Exceptions: “ \overline{OL} ” appears at the display as of 1000.0 V in the case of voltage measurement in the 1000 V range, as of 5.100 V for diode testing, and as of 11.00 A in the 10 A range.

4.3.2 Analog Display

Measured Value, Polarity

The analog display demonstrates the dynamic performance of a moving-coil mechanism. This display is especially advantageous for observing measured value fluctuation, and for balancing procedures.

Display mode Pointer: the current measured value is tracked in real-time.

The analog scale displays a negative range of 5 scale divisions for the measurement of zero-frequency quantities, allowing for precise observation of measured value fluctuation around zero. If the measured value exceeds the negative range of 5 scale divisions, polarity is reversed at the analog display.

Scaling of the analog scale is automatic. This is very helpful for manual measuring range selection.

Overranging

Overranging in the positive range is displayed by means of the right triangle symbol.

Refresh Rate

In the bar graph and pointer modes, the analog display is refreshed 40 times per second.

4.4 Measured Value Storage: DATA (auto-hold / compare)

An individual measured value can be automatically “frozen” with the DATA function (auto-hold). This is useful, for example, when contacting the measuring points with the test probes requires your full attention. After the measuring signal has been applied and the measured value has settled in accordance with the “condition” listed in the table below, the measured value is frozen at the digital display and an acoustic signal is generated. The test probes can now be removed from the measuring points, and the measured value can be read from the digital display. If the measuring signal falls below the value specified in the table, the function is reactivated for storage of the next value.

Measured Value Comparison (DATA Compare)

If the currently frozen value deviates from the first saved value by less than 100 digits, the acoustic signal is generated twice. If deviation is greater than 100 digits, only one brief acoustic signal is generated.

Note

The DATA function has no effect on the analog display, at which the current measured value continues to appear. However, when the digital display is “frozen”, the decimal point is fixed as well (fixed measuring range, symbol: MAN). The selected measuring range should not be manually changed as long as the DATA function is active.

The DATA function is deactivated by pressing and holding the **DATA/MIN/MAX** key (approx. 1 second), when the measuring function is changed or when the instrument is switched off and back on again.

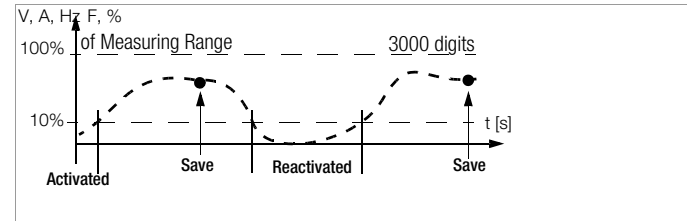

DATA Function	Press DATA / Min/Max	Condition		Response from Instrument		
		Measuring Function	Measuring Signal	MV Digital	DATA	Acoustic
activate	brief				blinks	once
save (stabilized measured value)		V, A, F, Hz, %	> 10% of R	is displayed	static	once twice ²⁾
		Ω	$\neq \Omega L$			
reactivate ¹⁾		V, A, F, Hz, %	< 10% of R	stored MV	blinks	
		Ω	$= \Omega L$			
change to Min/Max	brief	See table in chapter 4.4.2				
exit	long			is cleared	is cleared	twice

¹⁾ Reactivation results from falling short of specified measured value limits.

²⁾ Two acoustic signals are generated the first time a measured value is saved as a reference value. For subsequent data hold, two acoustic signals are only generated if the currently frozen value deviates from the **first** saved value by less than 100 digits.

Key: MV = measured value, R = measuring range

Example

The voltage measuring range is set manually to 30 V. The first measured value is 5 V and is stored to memory because it is greater than 10% of the measuring range (= 3 V), and is thus reliable above the background noise level. As soon as the measured values drops to less than 10% of the measuring range, i.e. amounts to less than 3 V which corresponds to removal of the test probes from the measuring point, the instrument is ready to store a new value.

4.4.1 Function DATA during insulation measurement *

This DATA function differs from the standard DATA-Compare function.

In the interference voltage measurement function $V(ac+dc)1M\Omega$, the special DATA function for insulation measurement is activated by pressing the **DATA** key – DATA blinks in the display. During interference voltage measurement, no DATA values are determined or stored yet. By briefly pressing the **FUNC | ENTER** key, the insulation measurement is activated and the test voltage is applied. An intermittent acoustic signal indicates to the user that the test voltage is applied (accompanied by a blinking of the ISO symbol in the display). After applying the test probes, a check is being made as to whether a valid measured value is present. As soon as a stable measured value appears in the display, the DATA value is stored (frozen in the display). A long acoustic signal indicates that the measurement is completed, the test voltage is switched off again, DATA no longer blinks and the user can read and note down the measured value. By repeatedly pressing the **FUNC | ENTER** key, the test voltage is applied again and DATA is activated (DATA blinks in the display).

If no DATA value is determined or if OL is shown in the display, the test voltage is automatically switched off after approx. 10 seconds. In order to deactivate the DATA function, the **FUNC | ENTER** key must be pressed and held.

* This function is especially available for variant METRAHIT ISO AERO, for other variants as from firmware version 1.18.

4.4.2 Saving Minimum and Maximum Values – MIN/MAX Function

Minimum and maximum measured values applied to the measuring instrument's input after the Min/Max function has been activated can be "frozen" at the display. The most important use of this function is the determination of minimum and maximum values during long-term measured value observation.

The Min/Max function can be activated in all measuring functions.

The Min/Max function has no effect on the analog display, at which the current measured value continues to appear.

Apply the measured quantity to the instrument and set the measuring range with the **MAN / AUTO** key before activating the Min/Max function.

The Min/Max function is deactivated by pressing and holding the **DATA/MIN/MAX** key (approx. 1 second), when the measuring function is changed or when the instrument is switched off and back on again.



Note

As opposed to the DATA function, the Min/Max function can also be used for temperature measurement.

Function Min/Max	Press DATA / Min/Max	Min. and Max. Measured Values	Response from Instrument		
			Display Measured Value Digital	Max. Min.	Acous- tic Signal
1 activate and save	2 x brief	are saved	current measured value	max and min	twice
2 save and display	brief	storage continues in background, new min. and max. values are displayed.	saved min. value	min.	once
	brief		saved max. value	max.	once
3 return to 1	brief	same as 1, stored values are not deleted	same as 1	same as 1	once
stop	long	are deleted	current measured value	is deleted	twice

4.5 Measurement Data Recording

The multimeter is capable of recording measurement data using an adjustable sampling rate for long periods of time in the form of measurement series. Data are stored to a battery-backed memory module, and are retained even after the multimeter is switched off. The system acquires measured values relative to real-time.

Stored measured values can subsequently be read out with the help of **METRAWIN 10** software. The only prerequisite is a PC which is connected by means of an interface cable to the USB X-TRA bidirectional interface adapter, which is plugged onto a multimeter. See also chapter 7, “Interface Operation”.

Memory Parameters Overview

Parameter	Page: Header
<i>CLEAR</i>	25: Clear Memory
<i>EMPTY</i>	25: Clear Memory – appears after <i>CLEAR</i>
<i>OCCUP</i>	25: Querying Memory Occupancy
<i>RATE</i>	55: rATE – set the sampling rate
<i>START</i>	24: Starting Recording via Menu Functions
<i>STOP</i>	25: Ending Recording

The STORE Menu Function

- First set the **sampling rate** for memory mode operation (see chapter 6.4 the *rATE* parameter) , and then start memory mode operation.
- First select the desired measuring function and an appropriate measuring range.
- Check the battery charge level before starting long-term measurement recordings (see chapter 6.3). Connect the **NA X-TRA** power pack if required.

Starting Recording via Menu Functions

- Switch to the “**SET**” mode by pressing **MEASURE | SETUP**, and select the “**Store**” menu.

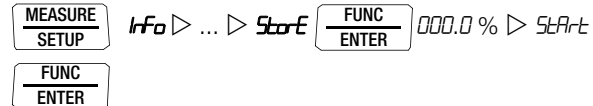

- Memory mode operation is started by activating **FUNC | ENTER**. **STORE** appears underneath the analog display and indicates that the memory mode has been activated. “**Stop**” appears at the digital display.
- Press **MEASURE | SETUP** in order to return to the measuring function.

During Recording

STORE is displayed underneath the analog display during memory mode operation, and **memory occupancy** can be monitored:

StoP ▷ 000.3%

The following message appears as soon as memory is full: "100.0%".

In order to be able to **observe measured values during recording**, switch to the measuring function by pressing **MEASURE | SETUP**. The display is returned to the memory menu after once again pressing **MEASURE | SETUP**.

A new memory block is created when another measuring function is selected with the rotary switch or the **FUNC | ENTER** key. Data storage then continues automatically.

Ending Recording

▷ "StoP" appears at the display after pressing **MEASURE | SETUP**.

StoP  Start

- ▷ Acknowledge the "StoP" display by pressing **FUNC | ENTER**. **STORE** is cleared from the display indicating that recording has been ended.
- ▷ Press **MEASURE | SETUP** in order to return to the measuring function.
- ▷ Memory mode operation can also be exited by switching the multimeter off.



Note

As soon as the internal memory is full, the recording ends automatically. Before recording, check the memory occupancy and set the parameters (especially the sampling rate) accordingly (see chapter 4.5 on page 24).

Querying Memory Occupancy

Memory occupancy can be queried during recording with the help of the "**Info**" menu (see also chapter 6.3).

Memory occupancy range: 000.1% to 099.9%.



 **Info**  bAtt: ▽ ... ▽ OCCUP %: 0 17.4 %

Memory occupancy can be queried before recording is started via the "**StoE**" menu.

 **Info** ▷ ... ▷ StoE  0 17.4% ▷ Start

Clear Memory

This function deletes all measured values from memory! This function cannot be executed during memory mode operation.

 **Info** ▷ ... ▷ StoE  0 17.4% ▷ Start
▷ CLEAR  EMPTY

5 Measurements

5.1 Voltage Measurement

Notes Regarding Voltage Measurement

- The multimeter may only be operated with installed batteries. Dangerous voltages are otherwise not indicated, and the instrument may be damaged.
- The multimeter may only be operated by persons who are capable of recognizing **contact hazards** and taking the appropriate safety precautions. Contact hazards exist anywhere, where voltages of greater than 33 V RMS may occur. The test probes may only be only gripped up to the finger guard. Do not touch the metallic test probes under any circumstances.
- Avoid working alone when taking measurements which involve **contact hazards**. Be certain that a second person is present.
- **Maximum allowable voltage** between terminals 9 or 10 and ground (8) is 1000 V for measuring category II, and 600 V for measuring category III.
- Be prepared for the occurrence of unexpected voltages at devices under test (e.g. defective devices). For example, capacitors may be dangerously charged.
- No measurements may be made with this instrument in electrical circuits with corona discharge (high-voltage).
- Special care is required when measurements are made in HF electrical circuits. Dangerous pulsating voltages may be present.

- Be aware of the fact that dangerous voltage spikes are not displayed during measurement with the low-pass filter. We recommend measuring voltage without the low-pass filter first, in order to be able to detect any dangerous voltages.
- Be absolutely certain that the measuring ranges are not overloaded beyond their allowable capacities. Limit values are included in chapter 8, "Technical Data", in the table entitled "Measuring Functions and Measuring Ranges" in the "Overload Capacity" column.

Note

Rotary selector switch position "**V 1M Ω / M $\Omega_{\text{@UISO}}$** " is available for the detection of interference voltage during insulation resistance measurement. Use switch position $\text{V}\sim$, $\text{V}\equiv$ or $\text{V}\approx$ in order to perform precise voltage measurements.

5.1.1 Direct and Pulsating Voltage Measurement, V DC and V (DC+AC)

- Set the CL, P parameter to **OFF** in the current clip setup menu. Otherwise all measured values are displayed in amperes, corrected by the amount resulting from the selected transformation ratio for an interconnected clip-on current sensor.



- In accordance with the voltage to be measured, turn the rotary switch to $\text{V}=\text{}$ or $\text{V}\approx$.
- Connect the measurement cables as shown. The “ \perp ” connector jack should be grounded.

Note

An intermittent acoustic signal warns the operator if the measured value exceeds the upper range limit in the 1000 V range.

Make sure that a current measuring range (“A”) has **not** been activated when the multimeter is connected for voltage measurement! If the fuse’s blowing limits are exceeded as a result of operator error, both the operator and the instrument are in danger!

With the rotary switch in the V position, the multimeter is always in the 1 V measuring range immediately after it is switched on. As soon as the **MAN / AUTO** key is pressed, and assuming the measured value is less than 280 mV, the multimeter is switched to the mV measuring range.

Measuring Ranges:
 $\text{V}=\text{}$: 100 μV ...1000 V
 $\text{V}\approx$: 10 mV...1000 V
 5 ranges: 300 mV, 3 V, 30 V, 300 V and 1000 V
Max. 1000 V, 3 kHz
 Hz: 1 Hz ... 300 kHz
 $P_{\text{max}} = 3 \times 10^6 \text{ V} \times \text{Hz}$

Warnings regarding dangerous voltage:
 > 15 V AC or > 25 V DC:
 > 1000 V: \square

5.1.2 Alternating Voltage and Frequency Measurement V AC and Hz with Selectable Low-Pass Filter

- Set the CLP parameter to **OFF** in the current clip setup menu. Otherwise all measured values are displayed in amperes, corrected by the amount resulting from the selected transformation ratio for an interconnected clip-on current sensor.

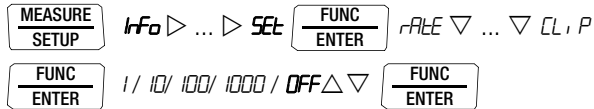

- In accordance with the voltage or frequency to be measured, turn the rotary switch to V~ or Hz/%.
- Connect the measurement cables as shown. The “ \perp ” connector jack should be grounded.

Voltage Measurement



Note

An intermittent acoustic signal warns the operator if the measured value exceeds the upper range limit in the 1000 V range.

- Make sure that a current measuring range (“A”) has not been activated, when the multimeter is connected for voltage measurement! If the fuse’s blowing limits are exceeded as a result of operator error, both the operator and the instrument are in danger!
- You can switch back and forth between voltage measurement with and without low-pass filter.
 - Repeatedly press the **FUNC | ENTER** multifunction key, until the V or V/Fil unit of measure appears at the display.

Frequency Measurement

- Connect the measured quantity in the same way as for voltage measurement.
- Manually select the measuring range for the voltage amplitude. When the instrument is switched to frequency measurement, the previously selected voltage measuring range remains active.
- You can switch back and forth between frequency measurement with and without low-pass filter. Repeatedly press the **FUNC | ENTER** multifunction key, until the Hz or Hz/Fil unit of measure appears at the display. Lowest measurable frequencies and maximum allowable voltages are included in chapter 8, “Technical Data”.

Measurement with Low-Pass Filter



Attention!

Be aware of the fact that dangerous voltage spikes are not displayed during this type of measurement (see also “Voltage Comparator”). We recommend measuring voltage without the low-pass filter first, in order to be able to detect any dangerous voltages.

A 1 kHz/-3 dB low-pass filter can be activated if required, in order to filter out capacitively induced high frequency pulses of greater than 1 kHz, for example when performing measurements at cables, i.e. undesired voltages of greater than 1 kHz can be suppressed.

“Fil” appears at the display in order to indicate the respectively activated low-pass filter. The multimeter is automatically switched to manual measuring range selection.

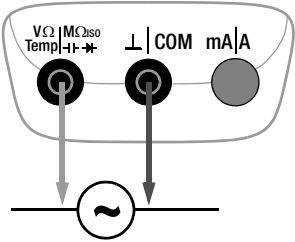

Specified measuring accuracy is not reached with signals of greater than 500 Hz when the filter is active.



Measuring Ranges:
 V~: 10 mV ... 1000 V
 5 ranges: 300 mV, 3 V, 30 V, 300 V and 1000 V

Max. 1000 V, 3 kHz
 Hz: 1 Hz ... 300 kHz
 $P_{\text{max}} = 3 \times 10^6 \text{ V} \times \text{Hz}$

Warnings regarding dangerous voltage:

- > 15 V AC or > 25 V DC: 
- > 1000 V: 

Voltage Comparator for Displaying Dangerous Voltage

The input signal or measuring signal is checked by a voltage comparator for dangerous spikes, because these do not appear at the display when the low-pass filter is used. At voltages of greater than 15 V AC or 25 V DC, a danger symbol appears at the display: .

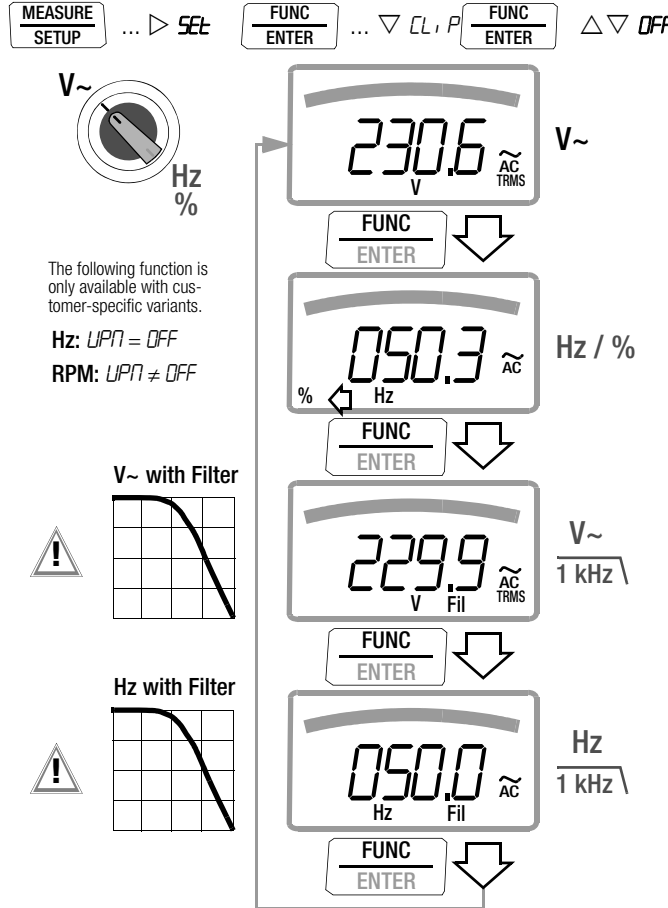

MEASURE SETUP ... \triangleright **SET** **FUNC ENTER** ... ∇ **CL, P** **FUNC ENTER** \triangle ∇ **OFF**

V~  **Hz %**

230.6 \sim AC TRMS V

FUNC ENTER \Downarrow

The following function is only available with customer-specific variants.

Hz: $UPN = OFF$
 RPM: $UPN \neq OFF$

Hz / %

050.3 \sim AC Hz

FUNC ENTER \Downarrow

V~ with Filter

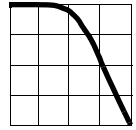
229.9 \sim AC TRMS V Fil $\frac{V}{1 \text{ kHz}}$

FUNC ENTER \Downarrow

Hz with Filter

050.0 \sim AC Hz Fil $\frac{\text{Hz}}{1 \text{ kHz}}$

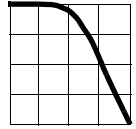
FUNC ENTER \Downarrow

Duty Cycle Measurement

(Function not available for METRAHIT ISO)

- ⇨ Set the rotary switch to V~.
- ⇨ Repeatedly press the **FUNC | ENTER** multifunction key until % appears at the display.
- ⇨ Connect the measurement cables as shown.

Make sure that a current measuring range ("A") has not been activated, when the multimeter is connected for frequency or duty cycle measurement!

The ratio of pulse duration to pulse period is measured with periodic square-wave signals and displayed as a percentage.

$$\text{Duty cycle (\%)} = \frac{\text{Pulse duration (}t_E\text{)}}{\text{Pulse period (}t_p\text{)}} \cdot 100$$



Note

The applied frequency must remain constant during duty cycle measurement.

V~
Hz
%

232.3
Hz

Hz
 \square
f_p

FUNC
ENTER

U
t_E t_p

002.0
%

%
t_E/t_p

Pulse Time Quantities

f_p pulse frequency = 1/t_p
 t_E pulse duration
 t_p pulse period
 t_p - t_E interpulse period
 t_E/t_p pulse or duty cycle

Measuring Ranges:

Hz	t _E /t _p
15 Hz ... 1 kHz	5 ... 95%
1 kHz ... 4 kHz	10 ... 90%

V Ω | M Ω_{ISO} Temp | \rightarrow | COM mA|A

RPM Measurement (function only available with customer-specific variant)

Revolutions per minute (also known as rotational frequency) are measured by acquiring pulses. As a prerequisite for this measurement, the number of measurable pulses per revolution must first be set in the RPM setup menu ($UPN \neq OFF$, see below).

⇒ Set the rotary switch to V~.

Repeatedly press the **FUNC | ENTER** multifunction key until RPM is briefly displayed. The measured value then appears in RPM, for example “244.3 r”.

$$\text{RPM} = \left(\frac{\text{Revolutions}}{\text{min}} / \frac{\text{Pulses}}{\text{Revolution}} \right) \times \frac{60\text{s}}{\text{s}}$$

Measured value RPM = revolutions per minute.

Parameter UPN = pulses per revolution.

Pulses per Revolution Setup Menu

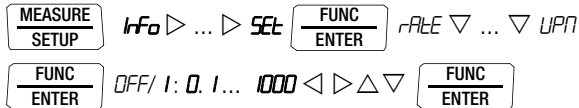

5.2 Resistance Measurement, Ω

- ⇨ Disconnect supply power from the electrical circuit of the device to be measured, and discharge all high-voltage capacitors.
- ⇨ Make sure that the device under test is voltage-free. Interference voltages distort measurement results! Refer to section 5.1.1 regarding testing for the absence of voltage with the help of the direct voltage measurement.
- ⇨ Set the rotary switch to “ Ω ”.
- ⇨ Connect the device under test as shown.



Note

Use short or shielded measurement cables in the case of high-impedance resistance.

Improving Accuracy by means of Zero Balancing

Cable resistance and contact resistance can be eliminated in all measuring ranges by means of zero balancing (see section 4.2).

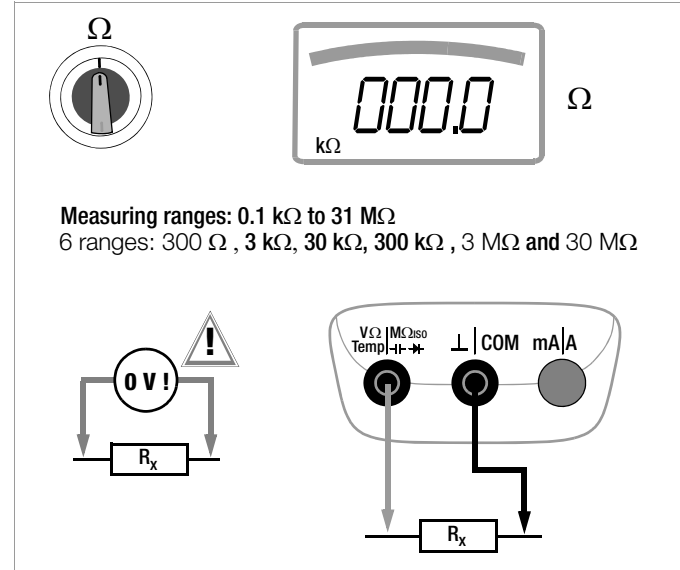

5.3 Temperature Measurement: Temp RTD and Temp TC

Temperature measurement is performed with a Pt100 or Pt1000 resistance thermometer, or a type K thermocouple (accessory, not included), which is connected to the voltage input.

Selecting the Unit of Measure for Temperature

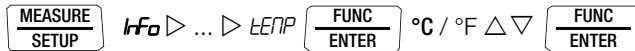

($^{\circ}\text{C}$ = default setting)

5.3.1 Measurement with Resistance Thermometers

⇒ Set the rotary switch to “Temp_{RTD}”.

Press the **FUNC | ENTER** key in order to change to the other measuring function if required.

The sensor type, i.e. Pt100 or Pt1000, is detected automatically and displayed.

There are two different ways to compensate for cable resistance:

Automatic Compensation

⇒ Acknowledge by pressing the **ZERO | ESC** key. “Short leads” appears at the display.

If you prefer to enter cable resistance directly, you can skip the following entry prompt.

⇒ Short circuit the measuring instrument’s connector cables. “000.0” appears at the display. After pressing the **FUNC | ENTER** key, automatic compensation of cable resistance is activated for all subsequent measurements. The short-circuit can now be eliminated, and the device is ready for use.

Enter Cable Resistance

⇒ Press the **ZERO | ESC** key once again in the automatic compensation menu.

⇒ Enter the known resistance of the connector cables with the scroll keys: Select the digit to be changed with the \blacktriangleleft \blacktriangleright keys, and change the respectively selected digit with the ∇ Δ keys. The default value is 0.16 Ω . Values can be selected within a range of 0 to 50 Ω .

⇒ Upon pressing the **FUNC | ENTER** key, the selected value is activated and the display is returned to the measuring function. Cable resistance remains in memory even after the instrument has been switched off.

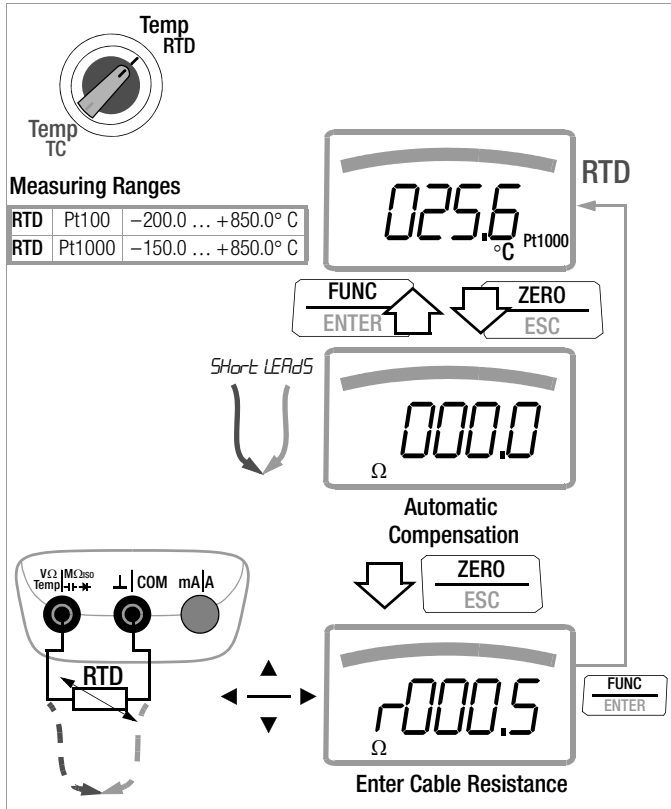

5.3.2 Measurement with Thermocouples, Temp TC

- Set the rotary switch to "Temp_{RTD}".



Note

The last selected temperature measurement or the last selected temperature sensor, i.e. type K or Pt100/Pt1000, remains in memory and is accordingly displayed. Press the **FUNC | ENTER** key in order to change to the other measuring function if required.

- The reference temperature is measured at the internal reference junction (see parameter "TEMP" in Seite 54 regarding querying).



Note

The internal reference temperature (temperature of the internal reference junction) is measured by a temperature sensor inside of the instrument. This may be somewhat above room temperature as a result of internal heat-up, or moving from warmer to colder surroundings or vice versa.

- Connect the sensor to the two accessible jacks. The instrument displays the measured temperature using the selected unit of measure.

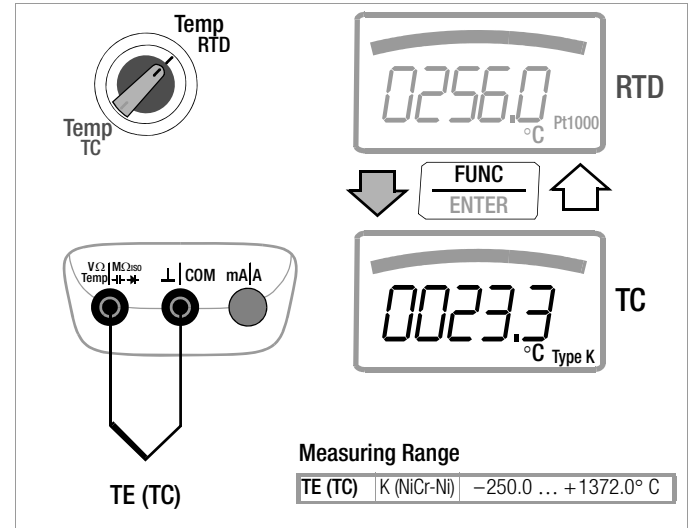

5.4 Continuity Test μ)

- ⇨ Disconnect supply power from the electrical circuit of the device to be measured, and discharge all high-voltage capacitors.
- ⇨ Make sure that the device under test is voltage-free. Interference voltages distort measurement results!
- ⇨ Set the rotary switch to " μ)".
- ⇨ A loudspeaker symbol appears at the display.
- ⇨ Connect the conductor path under test as shown.

Depending upon the selected limit value, the multimeter generates a continuous acoustic signal in the case of continuity or short-circuiting, i.e. at a value of less than the selected limit value. "**OL**" appears at the display in the case of an open connection. The limit value can be adjusted in the "**SET**" menu (see also section 6.4):

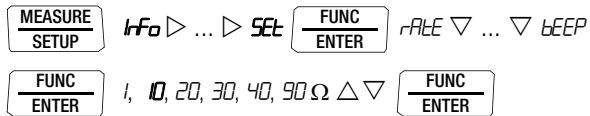

(10 = default setting)

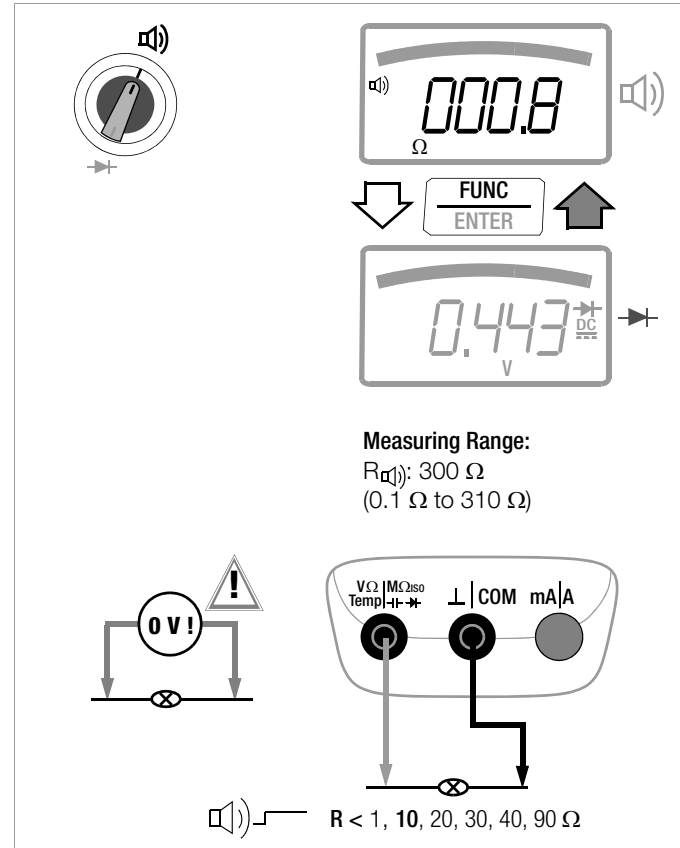

5.5 Diode Testing \rightarrow with Constant Current of 1 mA

- Disconnect supply power from the electrical circuit of the device to be measured, and discharge all high-voltage capacitors.
- Make sure that the device under test is voltage-free. Interference voltages distort measurement results! Refer to section 5.1.1 regarding testing for the absence of voltage with the help of the direct voltage measurement.
- Set the rotary switch to " \square ".
- Press the **FUNC | ENTER** key and the diode symbol appears at the display.
- Connect the device under test as shown.

Conducting Direction and Short-Circuit

The instrument displays forward voltage in volts (display: 4 places). As long as voltage drop does not exceed the maximum display value of 5.1 V, several series connected components or reference diodes with small reference voltages, as well as Z-diodes and LEDs, can be tested.

Reverse Direction and Interruption

The measuring instrument indicates overload **OL**

Note

Resistors and semiconductor paths connected in parallel to the diode distort measurement results!

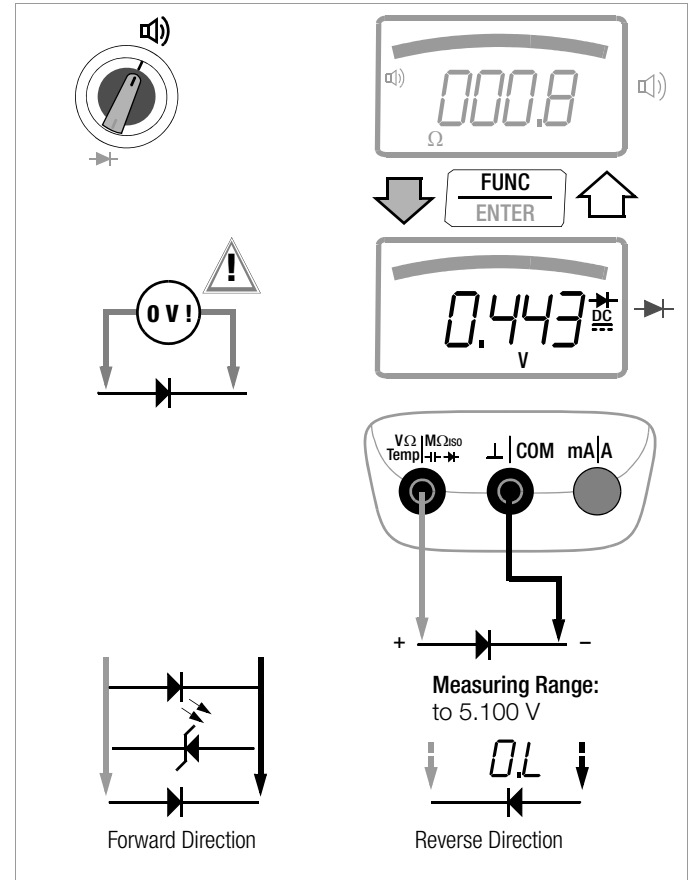

5.6 Capacitance Measurement $\text{--}\text{||}\text{--}$

- Disconnect supply power from the electrical circuit of the device to be measured, and discharge all high-voltage capacitors.
- Make sure that the device under test is voltage-free.
Capacitors must always be discharged before measurement is performed.
Interference voltages distort measurement results!
Refer to section 5.1.1 regarding testing for the absence of voltage with the help of the direct voltage measurement.
- Set the rotary switch to " $\text{--}\text{||}\text{--}$ ".
- Connect the (discharged!) device under test to the sockets with the measurement cables as shown.



Note

The " -- " pole of polarized capacitors must be connected to the " \perp " jack.

Resistors and semiconductor paths connected in parallel to the capacitor distort measurement results!

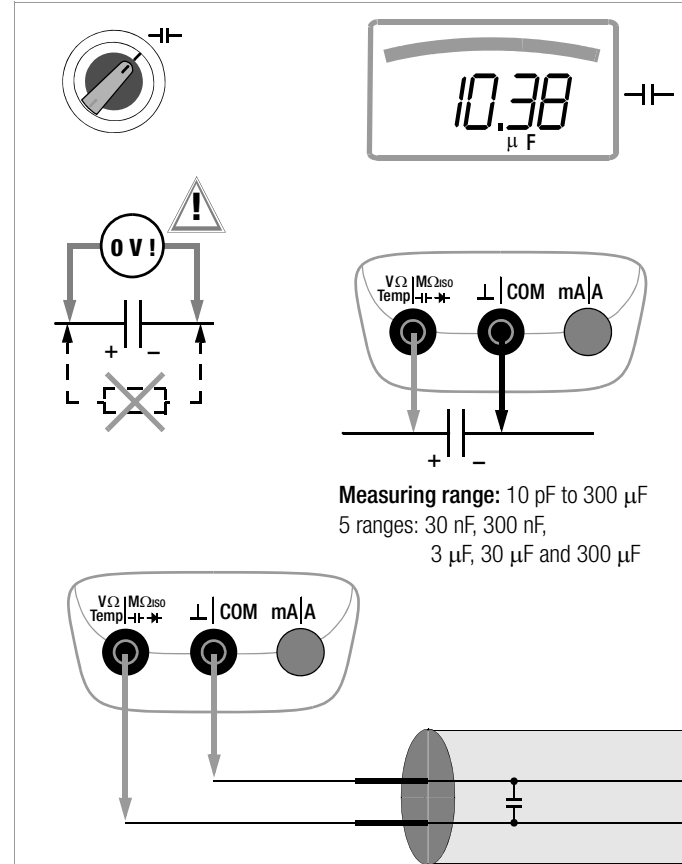

5.7 Insulation Resistance Measurement – $\text{M}\Omega_{\text{@ISO}}$

5.7.1 Preparing for Measurement



Note

Testing the Measurement Cables

The test probes at the ends of the measurement cables should be short circuited before performing insulation resistance measurements with the selector switch in the Ω or the \square position, in order to make sure that a value close to $0\ \Omega$ is displayed at the instrument. Incorrect connection or a broken measurement cable can be detected in this way.

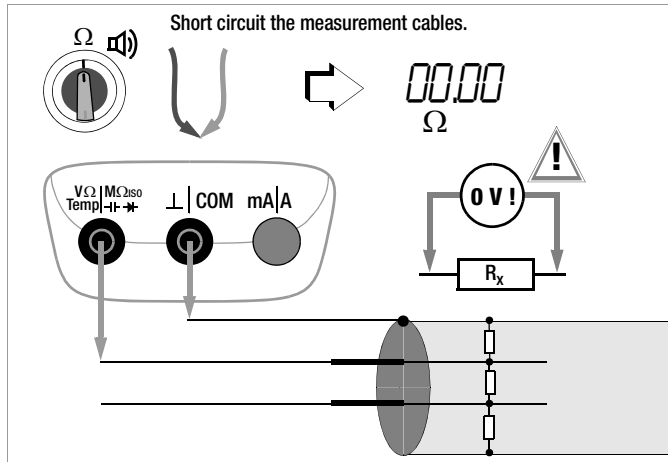

Note

Insulation resistance may only be measured at voltage-free devices. The measurement cables may not come into contact with one another during high-resistance insulation measurements.

- Set the rotary switch to “ $\text{M}\Omega_{\text{@ISO}}$ ”.
- Connect the measurement cables to the two accessible jacks.
- Interference voltage measurement (V AC+DC TRMS) is conducted in this switch position.

The **FUNC** | **ENTER** key for **Uiso ON / OFF** may only be pressed in order to start the insulation resistance measurement if the device under test is voltage-free.



Note

The $\text{M}\Omega_{\text{@ISO}}$ switch position may only be used for insulation resistance measurement and interturn short-circuit detection (**METRAHIT COIL**). However, if interference voltage is inadvertently applied with the switch in this position, it appears at the display. If an interference voltage of $> 50\ \text{V}$ is present, insulation resistance measurement is disabled. The LCD continues to display the interference voltage value. If a voltage of greater than $1000\ \text{V}$ is present, an acoustic signal is generated as well.



Caution: High-Voltage!

Do not touch the conductive ends of the test probes when the instrument has been activated for the measurement of insulation resistance. You may otherwise be exposed to a current of 2.5 mA (limited in the measuring instrument), and although this is not life endangering, the resulting electrical shock is quite discernible. If, on the other hand, measurement is being performed on a capacitive device under test, for example a cable, it may be charged with up to approximately $\pm 1200\text{ V}$. **Touching the device under test after measurement has been performed is life endangering in this case!**

Selecting the Test Voltage ($U_{\text{ISO}} = 50$ to 1000 V^*)

The desired test voltage can be selected in the “**SET**” menu (see also section 6.4):

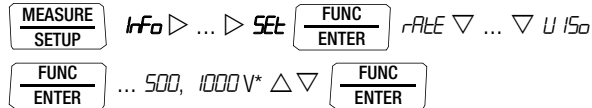

* Selectable test voltages and the default value depend upon the respective device variant.

Alternatively, the requested test voltage can be selected via the cursor keys $\triangleleft \triangleright$. Prerequisite: the multimeter is in switch position $\text{V}_{\text{M}\Omega}$ and in the AUTO range function.

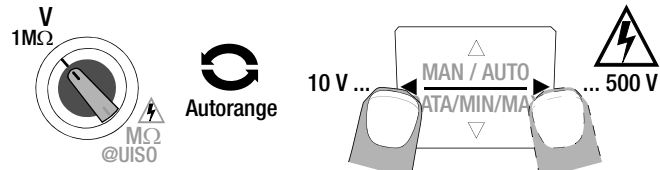

The selected test voltage appears at the display during testing.

5.7.2 Performing the Insulation Measurement

Starting the insulation resistance measurement:

Press and hold the **Uiso ON / OFF** key until the display settles in, in order to measure insulation resistance. Insulation resistance measurement is ended by releasing the key.

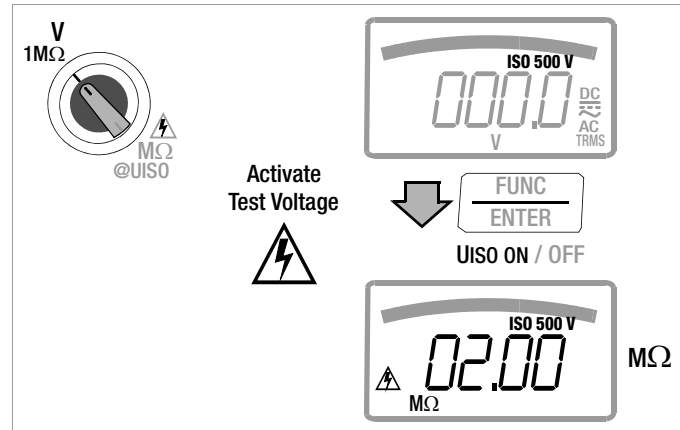

Auto-ranging is active during insulation resistance measurement.

For the automatic freezing of valid measured values, a DATA function specially geared to insulation measurement can be activated, see section 4.4.1.

Automatic Recognition of Interference Voltage during Insulation Resistance Measurement

If the instrument detects interference voltage of greater than **15 V AC** or **> 25 V DC** during insulation testing (condition: $U_{\text{interference}} \neq U_{\text{ISO}}$, e.g. $R_{\text{iq}} < 100 \text{ k}\Omega$ at 100 V, see Seite 62, footnote 1), **Error** is briefly displayed at the LCD. The instrument is then automatically switched to voltage measurement, and the currently measured voltage value is displayed.

Note

A dead zone results in erroneous measurements for automatic interference voltage detection during insulation resistance measurement. The dead zone lies within a range of 80% to 120% of the selected test voltage (in the case of an interference voltage whose value is equal to that of measuring voltage, the two voltages neutralize each other).

Manual switching to insulation resistance measurement is disabled for as long as voltage is applied to the test terminals.

If interference voltage is no longer present, the $\text{M}\Omega_{\text{@ISO}}$ measurement can be started by once again pressing the **Uiso ON / OFF** key.

Attention!

If **Error** appears at the display, the cable (the device under test) is most likely capacitively charged to a significant extent. Remedy: Short circuit the cable (the device under test). Repeat the measurement.

Special case indication of low insulation resistances up to short circuit

First „Error“ is displayed, and then briefly „Short“, followed by the current resistance measured value.

5.7.3 Ending the Measurement and Discharging



⇒ Briefly press the **Uiso ON / OFF** key.

After measurement has been completed, any remaining residual voltage is displayed which may result from cable capacitance. The instrument's internal $1 \text{ M}\Omega$ resistor causes rapid discharging. However, contact to the device under test must be maintained. The falling voltage value can be observed directly at the LCD.

Do not disconnect the device under test until the voltage value has dropped to < 25 V!

Note

The instrument's batteries are rapidly depleted during insulation resistance measurement. Deactivate insulation resistance measurement between measurements for this reason. Use only alkaline manganese batteries in accordance with IEC 6 LR61.

Note

Rotary selector switch position "**V $1\text{M}\Omega$ / $\text{M}\Omega_{\text{@ISO}}$** " is available for the detection of interference voltage during insulation resistance measurement. Use switch position $\text{V} \sim$, $\text{V} \equiv$ or $\text{V} \approx$ in order to perform precise voltage measurements.

5.8 Interturn Short-circuit Measurement – Function COIL/M $\Omega_{\text{@UISO}}$

This function can only be performed with the **METRAHIT COIL** device variant and only in combination with the **COIL TEST ADAPTER**. With this measurement, a partially periodic time value is determined in proportion to the inductivity of the respective winding for each motor coil or coil combination via a cyclical discharge at high voltage. A comparison of the measurement results allows for examining the symmetry of the motor coils and the detection of a potential interturn short-circuit as a result.

5.8.1 Preparing the Measurement

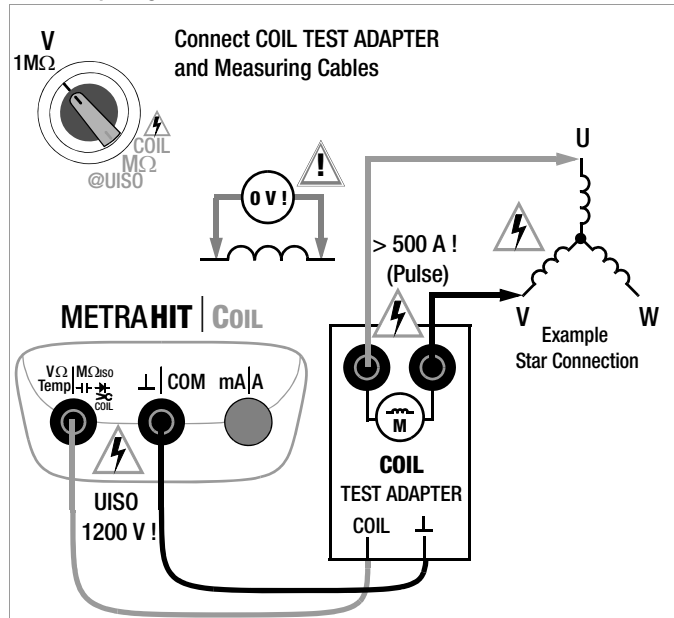

Note

Interturn short-circuit measurements may only be performed on voltage-free windings.

- Connect the **COIL TEST ADAPTER** with the two enabled jacks of the multimeter via the contact-protected plugs at the adapter connection cables: the red cable with the **COIL** jack and the black cable with the **COM** jack.
- Set the rotary switch at „**COIL/M $\Omega_{\text{@UISO}}$** “.
- Connect the two measurement cables with the two jacks of the **COIL TEST ADAPTER** (marked with a motor symbol).
- Establish contact between the inductive DUT and the (alligator) clips applied to the test probes. In the case of 3-phase current motors, for example, contact the winding connections U–V, W und U–W successively.
- An interference voltage measurement V AC+DC TRMS is conducted in this switch position.

Only if the DUT is voltage-free, are you allowed to press key **UCOIL ON / OFF** for interturn short-circuit measurement (and hold it until the measured value is stable).

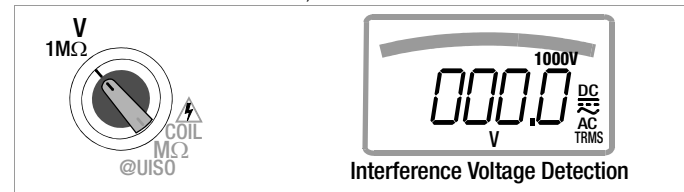

**Note**

The switch position **COIL/ $M\Omega_{@UISO}$** may only be used for interturn short-circuit measurement. However, any interference voltage accidentally applied is indicated in this switch position.

If an interference voltage of more than 50 V is present in the equipment, interturn short-circuit measurement is disabled. The LCD panel continues to display the interference voltage and the „Caution: High-Voltage“ symbol. If a voltage of more than 1000 V is applied, an additional acoustic signal is generated.

**Caution: High-Voltage!**

Do **not** touch the **conductive ends of the test probes** as long as the **U_{COIL ON / OFF}** key is being pressed.

A voltage of up to 1,200 Volt is present at the two enabled output jacks of the multimeter as well as, in the form of pulsed voltage, at the two output jacks of the **COIL TEST ADAPTER** (marked with a motor symbol).

Multimeter: A 2.5 mA current (limited in the measuring instrument) may flow through your body which, although it does not reach any life-threatening values, is perceptible nevertheless as a slight electric shock.

COIL TEST ADAPTER: Pulsed current of more than 500 A may be present at the output jacks.

The DUT may charge up: Wait after each measurement until the voltage at the DUT has decreased (interference voltage indication). If not, touching the DUT may pose a danger to life!

Test voltage ($U_{ISO} = 1000$ V)

The test voltage of the interturn short-circuit measurement has been fixed at 1000 V and cannot be changed. The display shows the momentary test voltage during measurement.

5.8.2 Performing Interturn Short-circuit Measurement

- Contact the winding in question (e.g. U–V) to check for absence of voltage.

**Attention!**

Do not measure without support, but rather with a self-retaining contact, for example alligator clips. Poor contact may lead to flying sparks, and slipping off the DUT may be life-threatening!

➤ **Activating interturn short-circuit measurement:**

- Press and hold the **U_{COIL ON / OFF}** key for measurement until the display of the time value has stabilized. In the display, a test voltage of 1000 V blinks.
- Read off the numeric value (indicated in μ sec) and note down the value together with the contacted winding.
- Release the **U_{COIL ON / OFF}** key to stop the measurement.

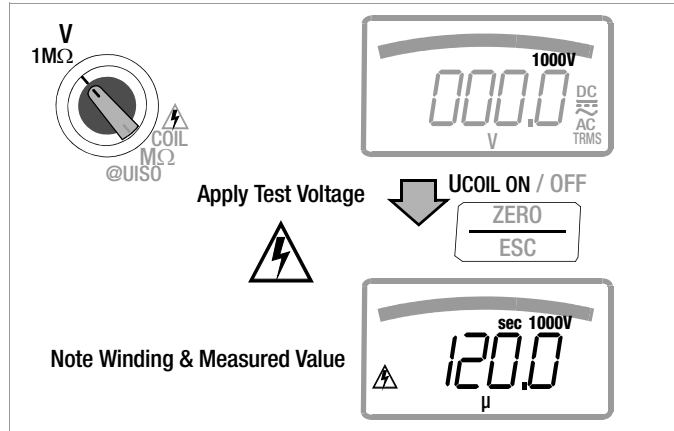

- ⇨ Allow the winding to be discharged via the multimeter before removing the contact, see Kap. 5.8.3.
- ⇨ Connect the next winding (e.g. V-W) and repeat the measuring procedure as described above.

Signalling of Measuring Progress

For better guidance, the first three test steps are marked accordingly.

On starting the first measurement, a (horizontal) segment left of the numeric field is shown.

On starting the second measurement, two segments are shown.

On starting the third measurement, three segments are shown. From the fourth measurement onwards, the three segments are shown intermittently.

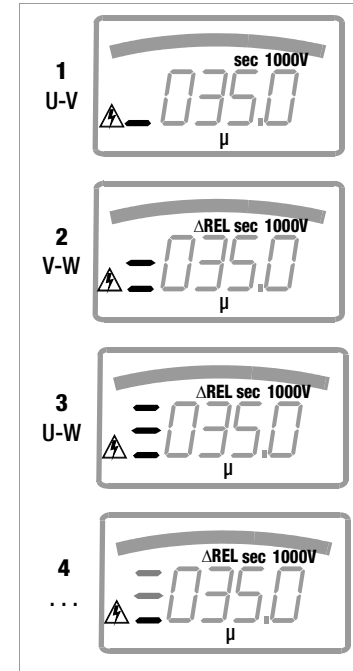

Automatic Evaluation of the Measuring Results

With the start of the second measurement, the automatic evaluation of the measuring results begins. The analog display* shows the maximum deviation in percent from all preceding measurements of the U_{COIL} measurement series. This allows for a direct comparison between the first and the subsequent measurements. By establishing a relation between the third measurement and the results of the preceding measurements, you automatically receive a concluding comparison of the 3 measurements.

Alternatively, you can measure at all 3 motor coils (star or delta connected), note down the values and compare them with each other for conclusion.

The admissible asymmetry depends on the motor type:

A motor with short-circuit rotor will not display any major asymmetry (typically 1%), whereas a permanently excited motor may display a certain degree of asymmetry, depending on the rotor position. At a deviation of more than 10 %, however, there is definitely a fault in the DUT (e.g. interturn short-circuit).

If a measured value is equal to 0, there is a short-circuit. If there is no discharge, the measured coil is open.

In order to start a new measurement series, briefly press the **MEASURE | SETUP** key twice or switch to another function (via rotary switch operation).

* the deviation is presented as a bargraph in function **COIL** (default setting), additionally ΔREL is shown.

5.8.3 Ending the Measurement and Discharging



➤ Release the **U_{COIL} ON / OFF** key.

After measurement has been completed, any remaining residual voltage is displayed which may result from cable capacitance. The instrument's internal 1 M Ω resistor causes rapid discharging.

The contact with the motor coils must be maintained.

The falling voltage value can be observed directly at the LCD.

Do not disconnect the device under test until the voltage value has dropped to < 25 V!

Note

Rotary selector switch position "**V 1M Ω / M Ω_{UISO}** " is available for the detection of interference voltage **prior to** interturn short-circuit measurement.

Use switch position $V \sim$, $V \equiv$ or $V \approx$ in order to perform precise voltage measurements.

5.9 Current Measurement

Notes Regarding Current Measurement

- The multimeter may only be operated with installed batteries or rechargeable batteries. Dangerous currents are otherwise not indicated, and the instrument may be damaged.
- Set up the measuring circuit in a mechanically secure fashion, and secure it against inadvertent breaks. Select conductor cross-sections and lay out connections such that they do not overheat.
- An continuous acoustic signal warns of current greater than 11 A.
- The input for the current measuring range is equipped with a fuse link. Maximum permissible voltage for the measuring circuit (= rated voltage of the fuse) is 1000 V AC/DC. Use specified fuses only! The fuse must have a **breaking capacity of at least 30 kA**.
- If the fuse for the active current measuring range blows, "FUSE" appears at the digital display, and an acoustic signal is generated at the same time.
- If a fuse should blow, eliminate the cause of overload before placing the instrument back into service!
- Fuse replacement is described in section 9.3.
- Be absolutely certain that the measuring ranges are not overloaded beyond their allowable capacities. Limit values are included in chapter 8, "Technical Data" in the table entitled "Measuring Functions and Measuring Ranges" in the "Overload Capacity" column.

Direct Current Measurement – CLIP Parameter = OFF

- Set the $CLIP$ parameter to **OFF** in the current clip setup menu. Otherwise all displayed measured values are corrected by the amount resulting from the selected transformation ratio for an interconnected clip-on current sensor.



Switch	FUNC	Display	Additional clip function (via CLIP 1:1/10/100/1000 in the SET menu)
A $\overline{=}$	0/2	A $\overline{=}$ DC	
A $\overline{=}$	1	A $\overline{=}$ DC AC TRMS	
A~	0/2	A~ AC TRMS	➤ AC (A) clip: clip-on current transformer
Hz (A)	1	Hz ~ AC	➤ Hz (A) clip: clip-on current transformer

5.9.1 Direct and Pulsating Current Measurement, Direct Connection, A DC and A (DC+AC)

- First disconnect supply power from the measuring circuit or the power consumer (1), and discharge any capacitors.
- In accordance with the current to be measured, set the rotary switch to A DC or A $\text{DC}+\text{AC}$.
- Select the type of current appropriate for the measured quantity by briefly pressing the **FUNC | ENTER** multifunction key. Each time the key is pressed, the instrument is switched back and forth between A DC and A (DC + AC)_{TRMS}, which is indicated by means of an acoustic signal. The current type is indicated at the LCD by means of the DC or the (DC+AC)_{TRMS} symbol.
- Safely connect the measuring instrument (without contact resistance) in series to the power consumer (2) as shown.
- Switch supply power to the measuring circuit back on (3).
- Read the display. Make a note of the measured value if the instrument is not being operated in the memory mode or the transmission mode.
- Disconnect supply power from the measuring circuit or the power consumer (1) once again, and discharge any capacitors.
- Remove the test probes from the measuring point and return the measuring circuit to its normal condition.

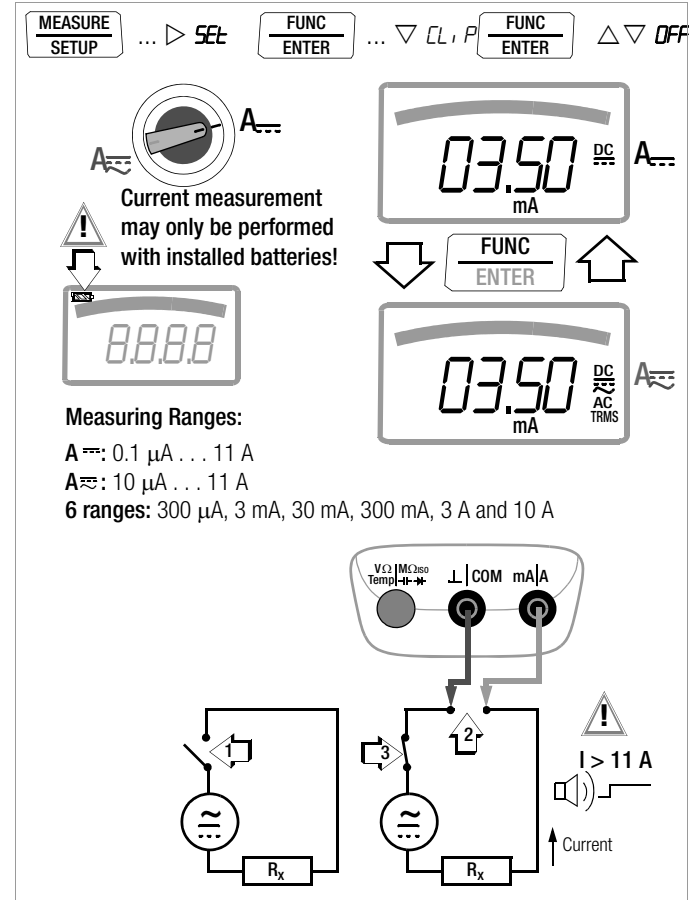

5.9.2 Alternating Current and Frequency Measurement, Direct Connection, A AC and Hz

- First disconnect supply power from the measuring circuit or the power consumer (1), and discharge any capacitors.
- In accordance with the current or frequency to be measured, turn the rotary switch to A~ or Hz.
- Select the desired measured quantity by briefly pressing the **FUNC | ENTER** multifunction key. Each time the key is pressed, AC_{TRMS} and Hz are alternately selected, and switching is acknowledged with an acoustic signal.
- Safely connect the measuring instrument (without contact resistance) in series to the power consumer as shown.
- Switch supply power to the measuring circuit back on (3).
- Read the display. Make a note of the measured value if the instrument is not being operated in the memory mode or the transmission mode.
- Disconnect supply power from the measuring circuit or the power consumer (1) once again, and discharge any capacitors.
- Remove the test probes from the measuring point and return the measuring circuit to its normal condition.

MEASURE SETUP ... \triangleright **SEL** **FUNC ENTER** ... ∇ **CL, P** **FUNC ENTER** $\triangle \nabla$ **OFF**

Hz **A~**

Current measurement may only be performed with installed batteries!

03.50 \sim **AC TRMS** **mA** **A~**

FUNC ENTER

050.1 \sim **Hz** **Hz**

Measuring Ranges:
A ~: 10 μ A ... 11 A
6 ranges: 300 μ A, 3 mA, 30 mA, 300 mA, 3 A and 10 A

Hz: 1 Hz ... 31 kHz
3 ranges: 300 Hz, 3 kHz and 30 kHz

V Ω | $M\Omega_{ISO}$ Temp | $\rightarrow I$ \rightarrow

\perp | COM mA/A

I > 11 A

Current

5.9.3 Direct and Pulsating Current Measurement with Clip-On Current Sensor A DC and A (DC+AC)

Transformer Output, Voltage/Current

When a clip-on current sensor is connected to the multimeter (V input), all current displays appear with the correct value in accordance with the selected transformation ratio. The only prerequisite is that the current sensor is equipped with at least one of the below listed transformation ratios, and that the ratio has been previously selected in the following menu ($\text{CL}, P \neq \text{OFF}$).

Current Clip Setup Menu

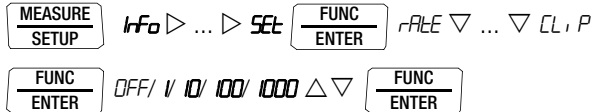

Transf. Ratio CL, P	Measuring Ranges			Clip Type
	300 mV	3 V	30 V	
1:1 1 mV / 1 mA	300.0 mA	3.000 A	30.00 A	WZ12C
1:10 1m V / 10 mA	3.000 A	30.00 A	300.0 A	WZ12B, Z201A/B
1:100 1m V / 100 mA	30.00 A	300.0 A	3,000 kA	Z202A/B METRAFLEX
1:1000 1 mV/1 A	300.0 A	3,000 kA	30.00 kA	Z202A/B, Z203A/B, WZ12C METRAFLEX

Maximum allowable operating voltage is equal to the current transformer's nominal voltage. When reading the measured value, additional error resulting from the clip-on current sensor must also be taken into consideration.

(default value: $\text{CL}, P = \text{OFF}$ = voltage display)

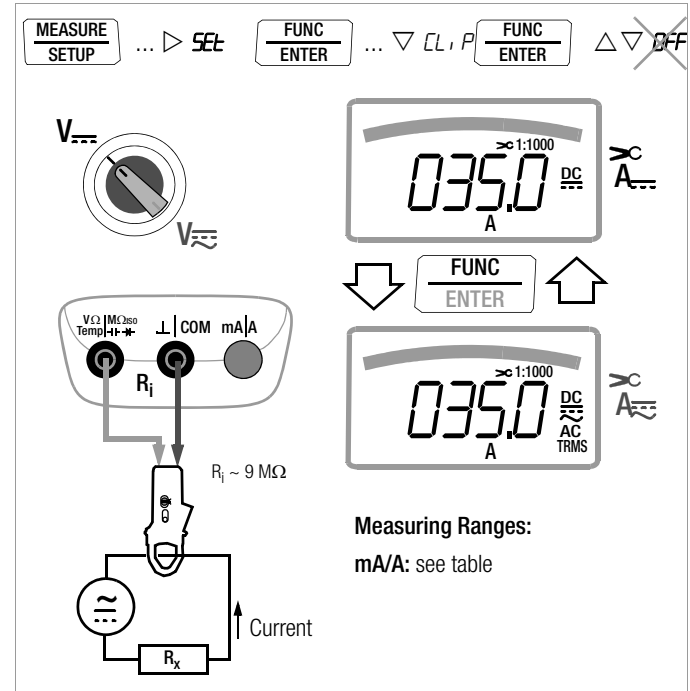

Measuring Ranges:
mA/A: see table

5.9.4 Alternating Current Measurement with Clip-On Current Sensor, A AC and Hz

Transformer Output, Voltage/Current

When a clip-on current sensor is connected to the multimeter (V input), all current displays appear with the correct value in accordance with the selected transformation ratio. The only prerequisite is that the current sensor is equipped with at least one of the below listed transformation ratios, and that the ratio has been previously selected in the following menu (**CL, P** \neq **OFF**).

Current Clip Setup Menu

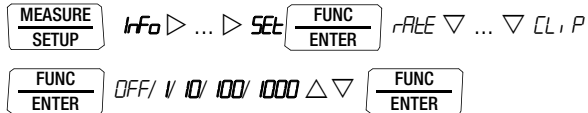

Transf. Ratio CL, P	Measuring Ranges			Clip Type
	300 mV	3 V	30 V	
1:1 1 mV / 1 mA	300.0 mA	3.000 A	30.00 A	WZ12C
1:10 1m V / 10 mA	3.000 A	30.00 A	300.0 A	WZ12B, Z201A/B
1:100 1m V / 100 mA	30.00 A	300.0 A	3,000 kA	Z202A/B METRAFLEX
1:1000 1 mV/1 A	300.0 A	3,000 kA	30.00 kA	Z202A/B, Z203A/B, WZ12C METRAFLEX

Maximum allowable operating voltage is equal to the current transformer's nominal voltage. When reading the measured value, additional error resulting from the clip-on current sensor must also be taken into consideration.

(default value: **CL, P** = **OFF** = voltage display)

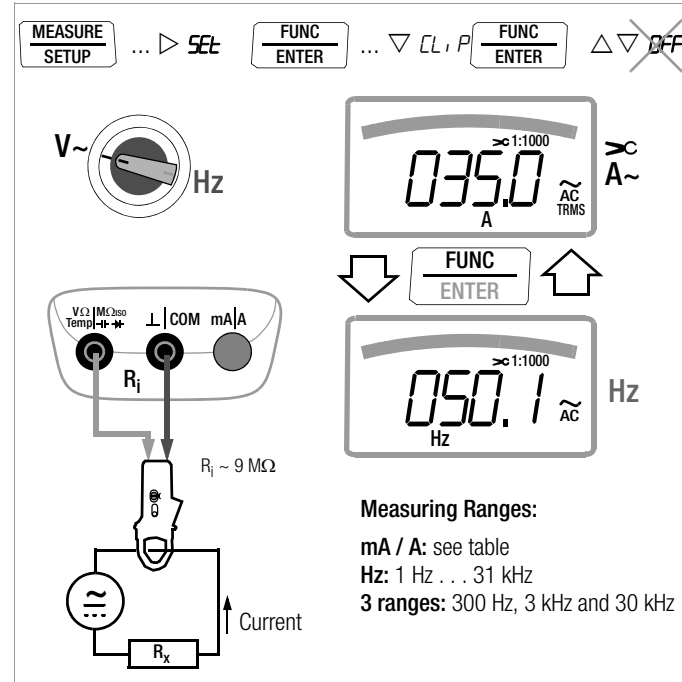

5.9.5 Alternating Current Measurement with A AC and Hz Clip-On Current Transformer

Current/Current Transformer Output

When a clip-on current transformer is connected to the multimeter (mA/A input), all current displays appear with the correct value in accordance with the selected transformation ratio. The only prerequisite is that the current transformer is equipped with at least one of the below listed transformation ratios, and that the ratio has been previously selected in the following menu ($\text{CL.P} \neq \text{OFF}$).

Current Clip Setup Menu



Transf. Ratios CL.P	DMM Measuring Ranges			Clip Types
	30 mA	300 mA	3 A	
1:1 1 mA / 1 mA	30.00 mA	300.0 mA	3.000 A	
1:10 1 mA / 10 mA	300 mA	3.000 A	30.00 A	
1:100 1 mA / 100 mA	3.000 A	30.00 A	300.0 A	
1:1000 1 mA / 1 A	30.00 A	300.0 A	3000.0 A	WZ12A, WZ12D, WZ11A, Z3511, Z3512, Z3514

The diagram illustrates the setup for measuring AC current using a clip-on transformer. The multimeter is connected to the transformer's secondary winding (R_i), which is in series with a load resistor (R_x) and a current source. The transformer's primary winding is clamped around the load resistor. The multimeter's display shows the measured current as 03.50 A AC TRMS and the frequency as 050.1 Hz AC. The transformer's internal resistance is noted as $R_i \leq 50 \Omega$.

Measuring Ranges:
 mA / A: see table
 Hz: 1 Hz ... 31 kHz
 3 ranges: 300 Hz, 3 kHz and 30 kHz

6 Device and Measuring Parameters

The instrument's "**SEtUP**" mode (menu mode) makes it possible to set operating and measuring parameters, query information and activate the interface.

- ↪ The menu mode is accessed by pressing the **MEASURE | SETUP** key, assuming that the instrument is switched on and set to "Measure" (measuring mode operation). "**rfo**" appears at the display.
- ↪ The main menus, i.e. the "**SEt**" and "**LENtP**" menus, as well as the "**SEnd**" and "**StorE**" menus, are accessed, and the display is returned to "**rfo**", by repeatedly activating the $\triangleleft \triangleright \triangle \nabla$ keys (in any direction).
- ↪ After selecting the desired main menu, sub-menus are accessed by pressing the **FUNC | ENTER** key.
- ↪ The desired parameter is selected by repeatedly pressing the $\triangle \nabla$ keys.
- ↪ In order to check or change a parameter, acknowledge it with the **FUNC | ENTER** key.
- ↪ The $\triangleleft \triangleright$ keys can be used to position the cursor at the entry position.
The desired value is selected with the help of the $\triangle \nabla$ keys.
- ↪ Changes can only be accepted with the **FUNC | ENTER** key.
- ↪ You can return to the sub-menu without making any changes by pressing the **ZERO | ESC** key, and to the main menu by pressing the **ZERO | ESC** key once again etc.
- ↪ You can switch to the measuring mode from any menu level by pressing the **FUNC | ENTER** key.

After repeatedly pressing the **MEASURE | SETUP** key (without first turning the multimeter off), you can return to the last selected menu or parameter from the measuring mode.

Example: Setting Time

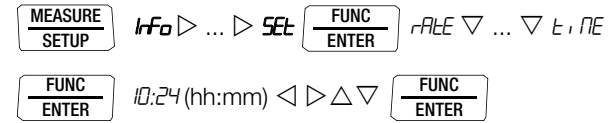

Setting hours and minutes:

- $\triangleleft \triangleright$ Advance to desired entry position.
- $\triangle \nabla$ Change the setting, the entry position blinks. Press and hold the key to change the setting rapidly.
- FUNC ENTER** The new time setting is activated after acknowledgement.

6.1 Paths to the Various Parameters

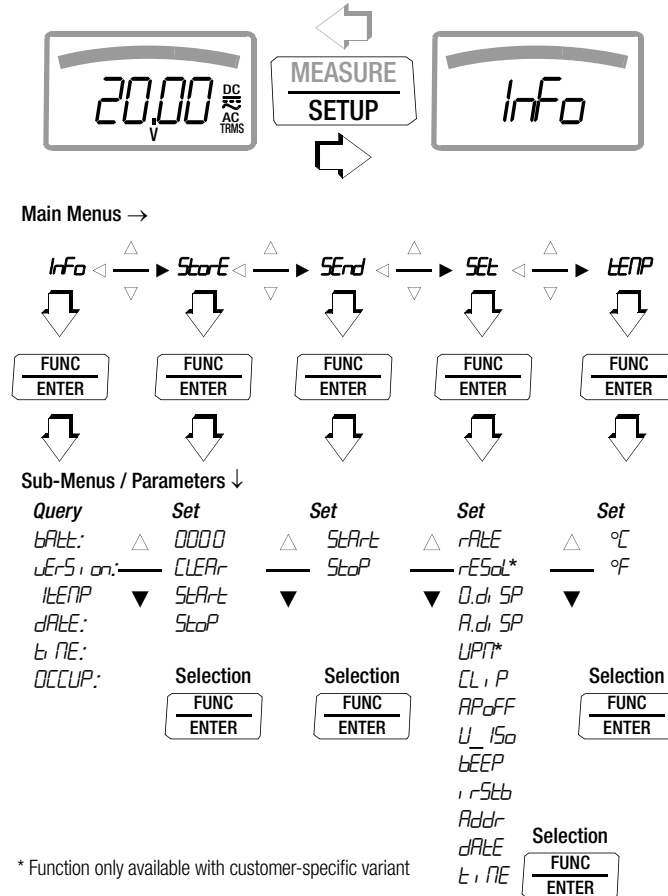

6.2 List of All Parameters

Parameter	Page: Header
<i>O.d, SP</i>	55: O.diSP – show/hide leading zeros
<i>R.d, SP</i>	55: A.diSP – Select display mode for the analog display
<i>Addr</i>	59: Configuring Interface Parameters
<i>APoFF</i>	56: APoFF – specified time for automatic shutdown and continuous ON
<i>bAtt</i>	54: bAtt – query battery voltage
<i>bEEP</i>	56: bEEP – set limit value for continuity testing
<i>CLEAR</i>	24: Measurement Data Recording
<i>CL, P</i>	49: Direct and Pulsating Current Measurement with Clip-On Current Sensor A DC and A (DC+AC) 50: Alternating Current Measurement with Clip-On Current Sensor, A AC and Hz
<i>dAtE</i>	54: dAtE – query date, 57: dAtE – enter date
<i>EMPTY</i>	24: Measurement Data Recording
<i>Info</i>	54: Querying Parameters – InFo Menu (as moving letters)
<i>rStb</i>	59: Configuring Interface Parameters
<i>tENP</i>	54: tEMP – query reference temperature
<i>OCCUP</i>	24: Measurement Data Recording
<i>rAtE</i>	55: rAtE – set the sampling rate
<i>rESdL</i>	55: rESoL – high resolution for V DC and W (customer-specific function)
<i>SEnd</i>	58: Activating the Interface
<i>SEt</i>	55: Entering Parameters – SETUP Menu
<i>StArt</i>	
<i>StoP</i>	24: Measurement Data Recording
<i>StorE</i>	
<i>tENP</i>	33: Temperature Measurement: Temp RTD and Temp TC
<i>t, nE</i>	54: tIME – query time, 57: tIME – set time
<i>U_150</i>	56: U_150 – select test voltage
<i>UPN</i>	56: RPM – revolutions per minute (customer-specific function)
<i>vErS, on</i>	54: vErSion – query firmware version

Device and Measuring Parameters

6.3 Querying Parameters – InFo Menu (as moving letters)

bAtt – query battery voltage



 *Info*  *bAtt: 2.75 V.*

vErSion – query firmware version



 *Info*  *bAtt: vErSion: 1.00*

ItEMP – query reference temperature

The temperature of the internal reference junction is measured with a temperature sensor in close proximity to the input sockets.

 *Info*  *bAtt: ItEMP: 24 °C*

dAtE – query date

 *Info*  *bAtt: dAtE: 31.12.05 (DD.MM.YY)*

D = day, M = month, Y = year

Date and time must be reentered after replacing the batteries.



tiME – query time

 *Info*  *bAtt: tiME: 13:46:56
(hh:mm:ss)*

h = hours, m = minutes, s = seconds

Date and time must be reentered after replacing the batteries.

OCCUP – query memory occupancy

 *Info*  *bAtt: OCCUP: 000.0%*

6.4 Entering Parameters – SETUP Menu

rAtE – set the sampling rate

The sampling rate specifies the time interval after which the respective measured value is transmitted to the interface, or to measured value memory.

Any one of the following sampling rates can be selected:
 [mm:ss.t]: 00:00,1, 00:00,2, **00:00.5**, 00:01,0, 00:02,0, 00:05.0
 [h:mm:ss.t] (h=hours, m=minutes, s=seconds, z=tenths of a sec.):
 0:00:10, 0:00:20, 0:00:30, 0:00:40, 0:00:50, 0:01:00, 0:02:00,
 0:05:00, 0:10:00, 0:20:00, 0:30:00, 0:40:00, 0:50:00, 1:00:00,
 2:00:00, 3:00:00, 4:00:00, 5:00:00, 6:00:00, 7:00:00, 8:00:00,
 9:00:00

Setting the Sampling Rate



(00:00.5 = 0.5 s = default value)

rESoL – high resolution for V DC and Ω (customer-specific function)

Switching back and forth between 3¾ and 4¾ places is possible for direct voltage and resistance measurement.

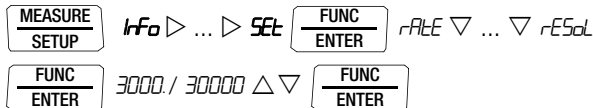

(3000 = default setting)

0.diSP – show/hide leading zeros

This parameter determines whether or not leading zeros will appear in the measured value display.

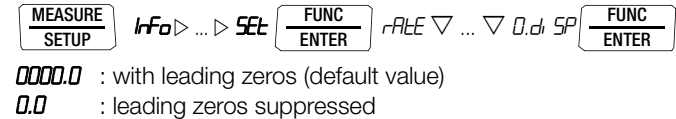

0000.0 : with leading zeros (default value)

0.0 : leading zeros suppressed



A.diSP – Select display mode for the analog display

One of two different display modes can be selected for the analog display:

- *bARc*: bar graph
- *POnt*: pointer

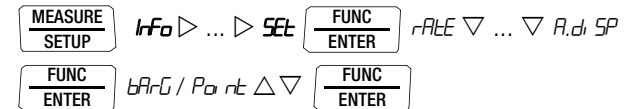

CLIP – set current clip factor

See chapter 5.9.3, chapter 5.9.4 and chapter 5.9.5.

Device and Measuring Parameters

APoFF – specified time for automatic shutdown and continuous ON

The instrument is switched off automatically if the measured value remains unchanged for a long period of time and if none of the keys or the rotary switch have been activated before the specified time “APoFF” (entered in minutes) has elapsed.

If the **on** setting is selected, the multimeter is set for long-term measurement and **ON** appears in the display to the right of the battery symbol. In this case, the multimeter can only be switched off manually. The “**on**” setting can only be cancelled by changing the respective parameter, and not by switching the instrument off.

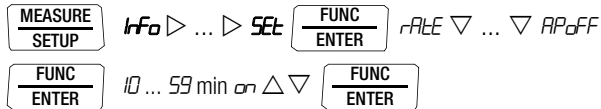

(10 minutes = default setting)

U_ISo – select test voltage

The desired test voltage for insulation resistance measurement can be selected here:

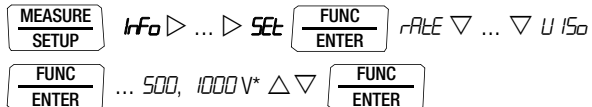

* Selectable test voltages and the default setting depend upon the respective customer-specific variant.

RPM – revolutions per minute (customer-specific function)

See section 5.1.2 regarding settings.

bBEEP – set limit value for continuity testing

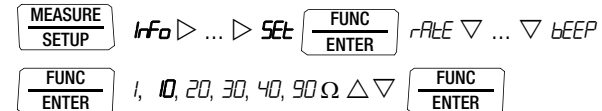

(10 Ω = default setting)

irStb – status of the infrared receiver in the stand-by mode

See chapter 7.2 on page 59 regarding settings.

Addr – set device address

See chapter 7.2 on page 59.

dAtE – enter date

Entering the current date makes it possible to acquire measured values in real-time.

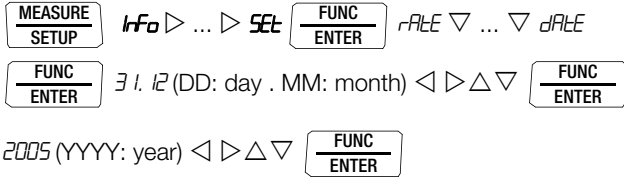

Date and time must be reentered after replacing the batteries.

tiME – set time

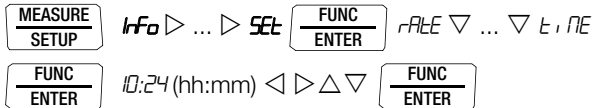

Entering the correct time makes it possible to acquire measured values in real-time.



Date and time must be reentered after replacing the batteries.

6.5 Default Settings

Previously entered changes can be undone, and the default settings can be reactivated. This may be advisable under the following circumstances:

- after the occurrence of software or hardware errors,
 - if you are under the impression that the multimeter does not work correctly.
- ⇒ **Disconnect the device from the measuring circuit.**
- ⇒ Remove the batteries temporarily (see also chapter 9.2).
- ⇒ Simultaneously press and hold the  and  keys, and connect the battery at the same time.

A sequence of acoustic signals consisting of two immediately consecutive tones acknowledges successful resetting.

7 Interface Operation

The multimeter is equipped with an infrared interface for the transmission of measurement data to a PC. Measured data are optically transferred through the instrument housing by means of infrared light to an interface adapter (accessory), which is attached to the multimeter. The adapter's USB interface allows for the establishment of a connection to the PC via an interface cable. Beyond this, commands and parameters can be transmitted from the PC to the multimeter as well. The following functions can be executed:

- Configuration and read-out of measuring parameters,
- Measuring function and measuring range selection,
- Start measurement,
- Read out stored measured values.

7.1 Activating the Interface

The interface is automatically activated for receiving operation (multimeter receives data from the PC) as soon as the interface is addressed by the PC, assuming that the “*ir5tb*” parameter has been set to “*ir on*” (see chapter 7.2), or the instrument is already switched on (the first command wakes up the multimeter, but does not yet execute any further commands).

The “continuous transmission” operating mode is selected manually as described below. In this operating mode, the instrument continuously transmits measurement data to the PC via the interface adapter, which can then be displayed with the help of a terminal program.

Starting Continuous Transmission Operation with Menu Functions



The **↓IR↑** symbol blinks at the display in order to indicate interface operation.

Stopping Continuous Transmission Operation with Menu Functions

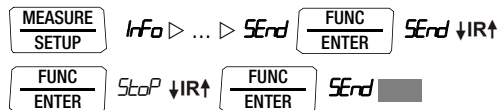

The **↓IR↑** symbol is cleared from the display.

Automatic Activation and Deactivation of Transmission Mode Operation

If the sampling rate is 10 seconds or longer, the display is switched off automatically between samples in order to prolong battery service life. The only exception is when the multimeter is set to continuous operation.

As soon as an event occurs, the display is automatically switched back on.

7.2 Configuring Interface Parameters

irStb – status of the infrared receiver in the stand-by mode

There are two possible switching statuses for the infrared interface when the multimeter is switched off:

- ir on*: IR appears at the display and the infrared interface is active, i.e. signals such as making commands can be received, and power is consumed even though the multimeter is switched off.
- ir off*: IR does not appear at the display and the infrared interface is switched off, signals cannot be received.

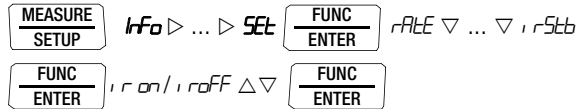

(*irStb* = *ir off* = default setting)



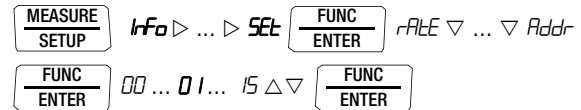

Addr – Address



If several multimeters are connected to the PC via an interface adapter, a separate address can be assigned to each instrument. Address number 1 should be selected for the first instrument, 2 should be assigned to the second and so forth.



(15 = default setting)

8 Technical Data

Meas. Function (input)	Measuring Range	Resolution at Upper Range Limit		Input Impedance		Intrinsic Uncertainty under Reference Conditions ±(... % rdg. + ... d)				Overload Capacity ²⁾		
		30000	3000	≡	~ / ≍	30000	3000	3000	3000	Value	Time	
						≡	≡	~ ^{1) 11)}	≍ ^{1) 11)}			
V	300.0 mV	10 μV	100 μV	9 MΩ	9 MΩ // < 50 pF	0.15 + 15 ¹⁰⁾	0.2 + 3 ¹⁰⁾	1 + 3 (> 100 D)	1.5 + 5 (> 100 D)	1000 V DC AC RMS Sine ⁶⁾	Cont.	
	3.000 V	100 μV	1 mV	9 MΩ	9 MΩ // < 50 pF	0.15 + 15	0.15 + 2	1 + 3 (> 30 D)	1.5 + 5 (> 100 D)			
	30.00 V	1 mV	10 mV	9 MΩ	9 MΩ // < 50 pF	0.15 + 15	0.15 + 2					
	300.0 V	10 mV	100 mV	9 MΩ	9 MΩ // < 50 pF	0.15 + 15	0.15 + 2					
	1000 V	100 mV	1 V	9 MΩ	9 MΩ // < 50 pF	0.15 + 15	0.2 + 2					
Voltage drop at approx. range limit							≡	~ ^{1) 11)}	≍ ^{1) 11)}			
A	300.0 μA		100 nA	18 mV	18 mV		0.5 + 5	1.5 + 5 (> 100 D)	1.5 + 5 (> 100 D)	0.3 A	Cont.	
	3.000 mA		1 μA	160 mV	160 mV		0.2 + 3					
	30.00 mA		10 μA	32 mV	32 mV		0.5 + 3					
	300.0 mA		100 μA	200 mV	200 mV		0.2 + 3					
	3.000 A		1 mA	120 mV	120 mV		1 + 5					
	10.00 A		10 mA	400 mV	400 mV		1 + 5					
Factor 1:1/10/100/1000		Input		Input impedance			≡	~ ^{1) 11)}	≍ ^{1) 11)}			
A  @ A	0.03/0.3/3/30 A		30 mA	Current measurement input (jack A~)			—	1.5 + 5 (> 100 D)	—	0.3 A	Cont.	
	0.3/3/30/300 A		300 mA									
	3/30/300/3k A		3 A			Plus clip-on current transformer error						3 A
A  @ V	0.3/3/30/300 A		300 mV	Voltage measurement input approx. 9 MΩ (⚡ V socket)			0.5 + 3	1.5 + 3 (> 300 D)	1.5 + 5 (> 300 D)	Meas. input ⁶⁾ :	max. 10 s	
	3/30/300/3k A		3 V						1.5 + 3 (> 30 D)			1.5 + 5 (> 100 D)
	30/300/3k/30k A		30 V			Plus clip-on current sensor error						
				Open-circuit voltage	Meas. current at range limit	±(... % rdg. + ... d)						
Ω	300.0 Ω	10 mΩ	100 mΩ	< 1.4 V	Approx. 300 μA	0.5 + 15 with ZERO active	0.5 + 3 with ZERO active			1000 V DC AC RMS Sine	max. 10 s	
	3.000 kΩ	100 mΩ	1 Ω	< 1.4 V	Approx. 200 μA	0.5 + 15	0.5 + 2					
	30.00 kΩ	1 Ω	10 Ω	< 1.4 V	Approx. 30 μA	0.5 + 15	0.5 + 2					
	300.0 kΩ	10 Ω	100 Ω	< 1.4 V	Approx. 3 μA	0.5 + 15	0.5 + 2					
	3.000 MΩ	100 Ω	1 kΩ	< 1.4 V	Approx. 0.3 μA	0.5 + 15	0.5 + 2					
	30.00 MΩ	1 kΩ	10 kΩ	< 1.4 V	Approx. 33 nA	2.0 + 20	2.0 + 5					
 Ω	300.0 Ω		100 mΩ	ca. 10 V	Approx. 1 mA const.	3 + 5						
 V	5.1 V ³⁾		1 mV	ca. 10 V		2 + 5						

Meas. Function (input)	Measuring Range	Resolution at Upper Range Limit		Intrinsic Uncertainty under Reference Conditions			Overload Capacity ²⁾	
			3000				Value	Time
F	30.00 nF	10 pF	10 MΩ	U_{0 max}	±(... % rdg. + ... d)	1000 V DC AC RMS Sine	max. 10 s	
	300.0 nF	100 pF	1 MΩ	0.7 V	1 + 6 ⁴⁾ with ZERO function active			
	3.000 μF	1 nF	100 kΩ	0.7 V	1 + 6 ⁴⁾			
	30.00 μF	10 nF	12 kΩ	0.7 V	1 + 6 ⁴⁾			
	300.0 μF	100 nF	3 kΩ	0.7 V	5 + 6 ⁴⁾			
				f_{min} ⁵⁾	±(... % rdg. + ... d)			
Hz (V)/ Hz (A)	300.0 Hz	0.1 Hz		1 Hz	0.1 + 2 ⁸⁾	Hz (V) ⁶⁾ Hz (A) ⁶⁾ : 1000 V : Hz (A) ⁷⁾	max. 10 s	
Hz (A) 	3.000 kHz	1 Hz		10 Hz				
Hz (A) 	30.00 kHz	10 Hz		100 Hz				
Hz (V)	300.0 kHz	100 Hz		100 Hz				
		Resolution	Voltage-R ¹³⁾	Frequency-R	±(... % R + ... d)			
%	2.0 ... 98.0	0.1 %	3 V	15 Hz ... 1 kHz	0.2% R + 8 d	1000 V DC AC RMS Sine ⁶⁾	Cont.	
	10.0...90.0			1 kHz ... 4 kHz	0.2% R/kHz + 8 d			
	5.0 ... 95.0		30 V	15 Hz ... 1 kHz	0.2% R + 8 d			
	10.0...90.0			1 kHz ... 4 kHz	0.2% R/kHz + 8 d			
				300 V & 1000 V possible, but not specified				
				±(... % rdg. + ... d) ⁹⁾				
°C	Pt 100 - 200.0 ... + 850.0 °C	0.1 °C			0.5 % + 15	1000 V DC/AC RMS Sine	max. 10 s	
	Pt 1000 - 150.0 ... + 850.0 °C				0.5 % + 15			
	K (NiCr-Ni) - 250.0 ... + 1372.0 °C				1 % + 5 K			

1) 15 ... 45 ... 65 Hz ... 10 (5) kHz sine. See following page for influences.

2) At 0 ° ... + 40 °C

3) Display of up to max. 5.1 V, "OL" in excess of 5.1 V.

4) Applies to measurements at film capacitors and with battery operation

5) Lowest measurable freq. for sinusoidal meas. signals symmetrical to zero point

6) Overload capacity of the voltage measurement input: power limiting: frequency x max. voltage 3 x 10⁶ V x Hz @ U > 100 V

7) Overload capacity of the current measurement input: See current measuring ranges for maximum current values.

8) Input sensitivity, sinusoidal signal, 10% to 100% of the voltage or current mea-

asuring range; limitation: up to 30% of the range at up to 100 kHz in the mV measuring range, 30% of the range in the 3 A measuring range. The voltage measuring ranges with max. 30 kHz apply in the A  measuring range.

9) Plus sensor deviation

10) With ZERO function active

11) Residual value of 1 to 10 d with short circuited terminal tips, exception: mV / μA range of 1 to 35 d at zero point due to the TRMS converter

12) 10 minute cool-down period

13) Required signal range 30% to 100% of the voltage measuring range

Key: R = meas. range, d = digit(s), rdg. = measured value (reading)

Insulation Resistance Measurement ¹⁾

Measuring Range	Resolution	Test voltage U_{ISO}	Digital Display Intrinsic Uncertainty under Reference Conditions
0,3 V ... 1000 V \approx ²⁾		$R_i=1M\Omega$	3 + 30 > 100 Digit
5 ... 310.0 k Ω	0.1 k Ω	50/100/250/500 V	3 + 5
0.280 ... 3.100 M Ω	1 k Ω	50/100/250/500/1000 V	3 + 5
02.80 ... 31.00 M Ω	10 k Ω	50/100/250/500/1000 V	5 + 5
028.0 ... 310.0 M Ω	100 k Ω	50/100/250/500/1000 V	5 + 5
0280 ... 3100 M Ω	1 M Ω	500/1000 V	5 + 5

¹⁾ During insulation measurement ($M\Omega_{@U_{ISO}}$): If „Error“ is displayed >> limits: $U_{interference} > 10...20$ V and $U_{interference} \neq U_{ISO}$, $R_i < 50$ k Ω @ U_{iso} 50 V, $R_i < 100$ k Ω @ U_{iso} 100 V, $R_i < 250$ k Ω @ U_{iso} 250 V, $R_i < 500$ k Ω @ U_{iso} 500 V, $R_i < 1000$ k Ω @ U_{iso} 1000 V

²⁾ Interference voltage measurement TRMS (V AC + DC) with 1 M Ω input resistance, Bandwidth 15 Hz ... 500 Hz, measuring error 3% + 30 Digit and in the 3 V and 30 V range, all values < 0.29 V are suppressed

Measuring Function	Nom. Voltage U_N	Open-Circuit Voltage U_o	Nom. Current I_N	Short-Circuit Current I_k	Acoustic Signal for	Overload Capacity	
						Value	Time
$U_{interference}/M\Omega_{@U_{ISO}}$	—	—	—	—	$U > 1000V$	1000 V \approx	dauernd
$M\Omega_{@U_{ISO}}$	50, 100, 250, 500 V	max. $1.2x U_{ISO}$	1.0 mA	< 1.2 mA	$U > 1000V$	1000 V \approx	10 s
$M\Omega_{@U_{ISO}}$	1000 V	max. $1.1x U_{ISO}$	0.5 mA	< 1.2 mA	$U > 1000V$	1000 V \approx	10 s

Interturn Short-circuit Measurement (METRAHIT COIL only)

Measuring Range	Resolution	Nominal Voltage U_{ISO}	Intrinsic Uncertainty at Reference Conditions \pm (% rdg. + d)
0.3 V ... 1000 V \approx ²⁾		$R_i=1M\Omega$	3 + 30 > 100 digits
10.0 ... 30.9 μ s	0.1 [μ s]	1000 V	10 + 5 digits
31 ... 250 μ s	1 [μ s]		

²⁾ Interference voltage measurement TRMS (V AC + DC) with an input resistance of 1 M Ω , frequency response width 15 Hz ... 500 Hz, accuracy of 3% + 30 digits; in the 3 V and 30 V range, all values below 0,29 V are suppressed

Short circuit measurement in the inductivity range:

10 μ H to 50 mH @ 100 Hz

Internal Clock

Time format TT.MM.JJJJ hh:mm:ss

Resolution 0.1 s

Accuracy ± 1 minute per month

Temperature influence 50 ppm/K

Influencing Quantities and Influence Error

Influencing Quantity	Sphere of Influence	Measured Quantity / Measuring Range ¹⁾	Influence Error (...% rdg. + ... d) / 10 K
Temperature	0 °C ... +21 °C and +25 °C ... +40 °C	V \approx	0.2 + 5
		V \sim	0.4 + 5
		300 Ω ... 3 M Ω	0.5 + 5
		30 M Ω	1 + 5
		mA/A \approx	0.5 + 5
		mA/A \approx	0.8 + 5
		30 nF ... 300 μ F	1 + 5
		Hz	0.2 + 5
	°C/°F (Pt100/Pt1000)	0.5 + 5	

¹⁾ With zero balancing

Influencing Quantity	Measured Quantity / Measuring Range	Sphere of Influence	Intrinsic Uncertainty ³⁾ ± (... % rdg. + ... d)	
Frequency	V _{AC} ²⁾	300 mV	> 15 Hz ... 45 Hz	2 + 5 > 300 Digit
		...	> 65 Hz ... 2 kHz	2 + 5 > 300 Digit
		300 V	> 2 kHz ... 10 kHz	3 + 5 > 300 Digit
		1000 V	> 65 Hz ... 5 kHz	3 + 5 > 60 Digit
	A _{AC}	300 µA ...	> 15 Hz ... 45 Hz	3 + 10 > 300 Digit
		10 A	> 65 Hz ... 10 kHz	
A _{AC+DC}	300 µA ...	> 15 Hz ... 45 Hz	3 + 30 > 300 Digit	
	10 A	> 65 Hz ... 10 kHz		
X _{AC}	300 mV / 3 V / 30 V ²⁾	> 65 Hz ... 10 kHz	3 + 5 > 300 Digit	
A _{AC} X _C	30 mA...3 A	> 65 Hz ... 10 kHz	3 + 30 > 300 Digit	

2) Power limiting: frequency x voltage, max. 3×10^6 V x Hz

3) The accuracy specification is valid as of a display value of 10% and up to 100% of the measuring range for both measuring modes with the TRMS converter in the A AC and A (AC+DC) ranges.

Influencing Quantity	Sphere of Influence	Measured Qty. / Measuring Range	Damping
Common Mode Interference Voltage	Interference quantity max. 1000 V ~	V =	> 120 dB
		3 V ~, 30 V ~	> 80 dB
	Interference quantity max. 1000 V ~ 50 Hz ... 60 Hz, sine	300 V ~	> 70 dB
		1000 V ~	> 60 dB
Series Mode Interference Voltage	Interference quantity: V ~ , respective nominal value of the measuring range, max. 1000 V ~ , 50 Hz ... 60 Hz sine	V =	> 50 dB
		Interference quantity max. 1000 V —	V ~

Influencing Quantity	Sphere of Influence	Measured Quantity / Measuring Range	Influence Error ⁵⁾
Crest Factor CF	1 ... 3	V ~, A ~	± 1% rdg.
	> 3 ... 5		± 3% rdg.

5) Except for sinusoidal waveshape

Influencing Quantity	Sphere of Influence	Measured Quantity	Influence Error
Relative Humidity	75%, 3 days, instrument off	V, A, Ω, F, Hz, °C	1 x intrinsic uncertainty
Battery voltage	2.0 to 3.6 V	ditto	Included in intrinsic uncertainty

Technical Data

Response Time (after manual range selection)

Measured Quantity / Measuring Range	Response Time Digital Display	Measured Quantity Jump Function
V $\overline{=}$, V \sim A $\overline{=}$, A \sim	1.5 s	From 0 to 80% of upper range limit value
300 Ω ... 3 M Ω	2 s	From ∞ to 50% of upper range limit value
30 M Ω , M $\Omega_{@UISO}$	Max. 5 s	
Continuity	< 50 ms	
$^{\circ}\text{C}$ (Pt 100)	Max. 3 s	
\rightarrow	1.5 s	From 0 to 50% of upper range limit value
30 nF ... 300 μF	Max. 5 s	
>10 Hz	1.5 s	

Reference Conditions

Ambient temperature	+23 $^{\circ}\text{C}$ \pm 2 K
Relative humidity	40% to 75%
Meas. Qty. Freq.	45 Hz ... 65 Hz
Meas. Qty. Waveshape	Sine
Battery voltage	3 V \pm 0.1 V

Ambient Conditions

Accuracy range	0 $^{\circ}\text{C}$... +40 $^{\circ}\text{C}$
Operating temp. range	-10 $^{\circ}\text{C}$... +50 $^{\circ}\text{C}$
Storage temp. range	-25 $^{\circ}\text{C}$... +70 $^{\circ}\text{C}$ (without batteries)
Relative humidity	40 to 75%, no condensation allowed
Elevation	to 2000 m
Deployment	Indoors, except within specified ambient conditions

Display

LCD panel (65 mm x 36 mm) with analog and digital display including unit of measure, type of current and various special functions

Background illumination

Background illumination is switched off approximately 1 minute after it has been activated.

Analog

Display
Scaling

LCD scale with pointer

Linear:

\mp 5 ... 0 ... \pm 30 with 35 scale divisions
for $\overline{=}$, 0 ... 30 with 30 scale divisions in all other ranges

Polarity display
Overflow display
Measuring rate

With automatic switching
With the \blacktriangleright symbol
40 measurements per second and display refresh

Digital

Display/Char. Height
Number of places

7-segment characters / 15 mm
3 $\frac{3}{4}$ places, \cong 3100 steps, convertible to 4 $\frac{3}{4}$ places* in measuring function V DC and Ω

Overflow display
Polarity display

"OL" is displayed for \geq 3100 digits
"-" (minus sign) is displayed
if plus pole is connected to "1"

Measuring rate

10 and 40 measurements per second with the Min/Max function except for the capacitance, frequency and duty cycle measuring functions

Refresh Rate

2 times per sec., every 500 ms

* Function only available with customer-specific variant

Power Supply

Battery	2 ea. 1.5 V mignon cell (2 ea. size AA), alkaline manganese per IEC LR6
Service life	With alkaline manganese batteries: approx. 200 hours (without $M\Omega_{@UISO}$ measurement)
Battery test	Battery capacity display with battery symbol in 4 segments:  . Querying of momentary battery voltage via menu function.
Power OFF function	The multimeter is switched off automatically: <ul style="list-style-type: none"> – If battery voltage drops to below approx. 2.0 V – If none of the keys or the rotary switch are activated for an adjustable duration of 10 to 59 minutes, and the multimeter is not in the continuous operation mode
Power pack socket	If the power pack has been plugged into the instrument, the installed batteries are disconnected automatically. Rechargeable batteries can only be recharged externally.

Measuring Function	Nominal Voltage U_N	Resistance of the DUT	Service life in Hours	Number of Possible Measurements with Nominal Current per VDE 0413
V \equiv			200 ¹⁾	
V \sim			150 ¹⁾	
M Ω	100 V	1 M Ω	50	
	100 V	100 k Ω		3000
	500 V	500 k Ω		600
	1000 V	2 M Ω		200

¹⁾ Times 0.7 for interface operation

Electrical Safety

Safety class	II per DIN EN 61010-1:2011/ VDE 0411-1:2011	
Measuring category	CAT II	CAT III
Nominal voltage	1000 V	600 V
Fouling factor	2	
Test voltage	5.2 kV~ per DIN EN 61010-1:2011/ VDE 0411-1:2011	

Fuses

Fuse link	FF 10 A/1000 V AC/DC; 10 mm x 38 mm; switching capacity: 30 kA at 1000 V AC/DC; protects the current measurement input in the 300 μ A through 10 A ranges
-----------	---

Electromagnetic Compatibility (EMC)

Interference emission	EN 61326-1:2013, class B
Interference immunity	EN 61326-1:2013 EN 61326-2-1:2013

Technical Data

Data Interface

Type	Optical via infrared light through the housing
Data transmission	Serial, bidirectional (not IrDa compatible)
Protocol	Device specific
Baud Rate	38,400 baud
Functions	<ul style="list-style-type: none">– Select/query measuring functions and parameters– Query momentary measurement data

The USB X-TRA plug-in interface adapter (see accessories) is used for adaptation to the PC's USB port.

Internal Measured Value Storage

Memory capacity	4 MBit / 540 kB for approx. 15,000 measured values with indication of date and time
-----------------	---

Mechanical Design

Housing	Impact resistant plastic (ABS)
Dimensions	200 x 87 x 45 mm (without protective rubber cover)
Weight	Approx. 0.35 kg with batteries
Protection	Housing: IP 54 (pressure equalization by means of the housing)

Table Excerpt Regarding Significance of the IP Code

IP XY (1 st digit X)	Protection against foreign object entry	IP XY (2 nd digit Y)	Protection against the penetration of water
4	≥ 1.0 mm dia.	4	splashing water
5	dust protected	5	water jets

9 Maintenance and Recalibration



Note

Disconnect the instrument from the measuring circuit before opening the battery compartment lid or fuse cover when replacing batteries or fuses!

9.1 Displays – Error Messages

Message	Function	Meaning
<i>FUSE</i>	Current measurement	Blown fuse
	In all operating modes	Battery voltage has fallen below 2.0 V
<i>OL</i>	Measurement	Indicates overflow
	$M\Omega_{ISO}$ measurement	Measured value of less than 10% of the measuring range
<i>Error</i>	$M\Omega_{ISO}$ measurement	Interference voltage detected

9.2 Batteries



Note

Removing the Batteries During Periods of Non-Use

The integrated quartz movement draws power from the batteries even when the instrument is switched off. It is advisable to remove the batteries during long periods of non-use for this reason (e.g. vacation). This prevents excessive depletion of the battery, which may result in damage under unfavorable conditions.



Note

Battery Replacement

Stored measurement data are lost when the batteries are replaced. In order to prevent data loss, it is advisable to backup your data to a PC with the help of **METRAWIN 10** software before replacing the batteries.

The selected operating parameters remain in memory, although date and time must be reentered.

Battery

The current battery charge level can be queried in the “**Info**” menu:

Info
batt: 2.75 V.

Make sure that no battery leakage has occurred before initial start-up, as well as after long periods of storage. Continue to inspect the batteries for leakage at short, regular intervals.

If battery leakage has occurred, carefully and completely clean the electrolyte from the instrument with a damp cloth, and replace the battery before using the instrument.

If the “” symbol appears at the display, the batteries should be replaced as soon as possible. You can continue working with the instrument, but reduced measuring accuracy may result.

The instrument requires two 1.5 V batteries in accordance with IEC LR 6, or two equivalent rechargeable NiCd batteries.

Replacing the Batteries



Attention!

Disconnect the instrument from the measuring circuit before opening the battery compartment lid in order to replace the batteries.

- ⇨ Set the instrument face down onto the working surface.
- ⇨ Turn the slotted screw on the lid with the battery symbols counterclockwise.
- ⇨ Lift off the lid and remove the batteries from the battery compartment.
- ⇨ Insert two new 1.5 V mignon batteries into the battery compartment, making sure that the plus and minus poles match up with the provided polarity symbols.
- ⇨ When replacing the battery compartment lid, insert the side with the guide hooks first. Tighten the screw by turning it clockwise.
- ⇨ Please dispose of depleted batteries in accordance with environmental protection regulations!

9.3 Fuses

Testing the Fuse

The fuse is tested automatically:

- When the instrument is switched on with the rotary switch in the A position
- When the instrument is already on and the rotary switch is turned to the A position
- In the active current measuring range when voltage is applied

If the fuse is blown or has not been inserted, “FuSE” appears at the digital display. The fuse interrupts the current measuring ranges. All other measuring ranges remain functional.



Replacing the Fuse

If a fuse should blow, eliminate the cause of overload before placing the instrument back into service!



Attention!

Disconnect the instrument from the measuring circuit before opening the fuse cover in order to replace the fuse!

- ⇨ Set the instrument face down onto the working surface.
- ⇨ Turn the slotted screw on the cover with the fuse symbol counterclockwise.
- ⇨ Lift off the cover and pry the fuse out using the flat side of the fuse cover.
- ⇨ Insert a new fuse. Make sure that the fuse is centered, i.e. between the tabs at the sides.
- ⇨ When replacing the fuse cover, insert the side with the guide hooks first. Tighten the screw by turning it clockwise.
- ⇨ Dispose of the blown fuse with the trash.



Attention!

Use specified fuses only!

If fuses with other blowing characteristics, other current ratings or other breaking capacities are used, the operator is placed in danger, and protective diodes, resistors and other components may be damaged.

The use of repaired fuses or short-circuiting the fuse holder is prohibited.



Note

Testing the Fuse with the Instrument Switched On

After inserting the fuse with the instrument switched on, the instrument must be switched off briefly and then switched back on, or briefly switched to a non current measuring range and then back to the A measuring range.

If contact is poor or the fuse is blown, FUSE appears at the display.

9.4 Housing Maintenance

No special maintenance is required for the housing. Keep outside surfaces clean. Use a slightly dampened cloth for cleaning. Avoid the use of cleansers, abrasives or solvents.

9.5 Return and Environmentally Sound Disposal

The instrument is a category 9 product (monitoring and control instrument) in accordance with ElektroG (German electrical and electronic device law). This device is subject to the WEEE directive. Furthermore, we make reference to the fact that the current status in this regard can be accessed on the Internet at www.gossenmetrawatt.com by entering the search term WEEE.

We identify our electrical and electronic devices in accordance with WEEE 2012/19/EU and ElektroG with the symbol shown at the right per DIN EN 50419.



These devices may not be disposed of with the trash.

Please contact our service department regarding the return of old devices (see page 4).

If you use **batteries** or **rechargeable batteries** in your instrument or accessories which no longer function properly, they must be duly disposed of in compliance with the applicable national regulations.

Batteries or rechargeable batteries may contain harmful substances or heavy metal such as lead (Pb), cadmium (Cd) or mercury (Hg).

The symbol shown to the right indicates that batteries or rechargeable batteries may not be disposed of with the trash, but must be delivered to collection points specially provided for this purpose.



9.6 Recalibration

The respective measuring task and the stress to which your measuring instrument is subjected affect the ageing of the components and may result in deviations from the guaranteed accuracy. If high measuring accuracy is required and the instrument is frequently used in field applications, combined with transport stress and great temperature fluctuations, we recommend a relatively short calibration interval of 1 year. If your measuring instrument is mainly used in the laboratory and indoors without being exposed to any major climatic or mechanical stress, a calibration interval of 2-3 years is usually sufficient.

During recalibration* in an accredited calibration laboratory (DIN EN ISO/IEC 17025) the deviations of your instrument in relation to traceable standards are measured and documented. The deviations determined in the process are used for correction of the readings during subsequent application.

We are pleased to perform DAkkS or factory calibrations for you in our calibration laboratory. Please visit our website at www.gossenmetrawatt.com.

By having your measuring instrument calibrated regularly, you fulfill the requirements of a quality management system per DIN EN ISO 9001.

* Verification of specifications or adjustment services are not part of the calibration. For products from our factory, however, any necessary adjustment is frequently performed and the observance of the relevant specification is confirmed.

9.7 Manufacturer's Guarantee

All METRAHIT digital multimeters and calibration instruments are guaranteed for a period of 3 years after shipment. The manufacturer's guarantee covers materials and workmanship. Damages resulting from use for any other than the intended purpose or operating errors, as well as any and all consequential damages, are excluded.

The calibration certificate confirms that the product conformed to the specified technical data at the time of calibration. We guarantee the observance of the specified technical data within the admissible tolerance limits for a period of 12 months from delivery.

10 Accessories

10.1 General

The extensive accessories available for our measuring instruments are checked for compliance with currently valid safety regulations at regular intervals, and are expanded as required for new applications. Currently up-to-date accessories which are suitable for your measuring instrument are listed at the following web address along with photo, order number, description and, depending upon the scope of the respective accessory, data sheet and operating instructions: www.gossenmetrawatt.de.

10.2 Technical Data for Measurement Cables (scope of delivery: KS17-2 safety cable set)

Electrical Safety

Maximum Rated Voltage	600 V	1000 V	1000 V
Measuring Category	CAT IV	CAT III	CAT II
Maximum Rated Current	1 A	1 A	16 A
with safety cap applied	•	•	—
without safety cap applied	—	—	•

Please observe the maximum values of the electrical safety of the instrument.

Ambient Conditions (EN 61 010-031)

Temperature	−20 °C ... + 50 °C
Relative humidity	50 to 80%
Contamination level	2

Application KS17-2



Attention!

In conformity with standard DIN EN 61010-031, measurements in an environment according to measuring category III may only be performed with the safety cap applied to the test probe of the measurement cable.

For establishing contact in 4 mm jacks you have to remove the safety cap by levering out the snap lock of the safety cap with another sharp object (e.g. the second test probe).

10.3 Power Pack NA X-TRA (not included)

Use only power packs from Gossen Metrawatt GmbH only in combination with your instrument. This assures operator safety by means of an extremely well insulated cable, and safe electrical isolation (nominal secondary ratings: 5 V / 600 mA). Installed batteries are disconnected electronically if the power pack is used, and need not be removed from the instrument.



Note

Use of the power pack may result in an additional measuring error on account of capacitive coupling. We therefore recommend battery operation for measuring capacitance and AC quantities.

The specified technical data only apply for battery operation.

10.4 Interface Accessories (not included)

USB X-TRA Bidirectional Interface Adapter

This adapter makes it possible to connect cable multimeters, as well as STARLINE multimeters which are equipped with a serial IR interface, to the USB port at a PC. The adapter allows for data transmission between the multimeter and the PC.

METRAwin 10 PC Analysis Software

METRAwin 10 PC software is a multilingual, measurement data logging program* for recording, visualizing, evaluating and documenting measured values from METRAHIT multimeters.

Details on the system requirements are given in the installation instructions of **METRAwin 10/METRAwin 45**.

* runs under any IBM compatible Windows operating system

11 Index

Numerics

0.diSP 55

A

Addr 59

APoFF 56

Auflösung, hohe bei V DC und Ohm 55

Automatic Shutdown

 Disable 17

 Specify Time 17

Auto-Range Function 18

B

bAtt 54

Batteries

 Charge Level 68

 Level Indicator 13

 Periods of Non-Use 68

 Replacement 69

bEEP 56

C

Cable Resistance 33

Capacitance Measurement 38

Clip-On Current Sensor 49, 50

Continuity Test 36

Current Measurement

 Notes 46

D

dAtE 54, 57

Default Settings 57

Device Returns 70

Diode Test 37

Discharge 41, 45

Display Illumination 16

Duty Cycle Measurement 30

E

Error 41

Error Messages 68

F

Fuse

 Replacement 69

H

Hotline Produktsupport 3

I

Interfaces

 Accessories 73

 Statuses 13

Intertum Short-circuit Measurement 42

irStb 59

itEMP 54

M

Maintenance

 Housing 70

Manufacturer's Guarantee 71

Measured Value Storage

 DATA Function 21

 MIN/MAX Values 23

Measurement Cables 72

Measuring Category

 Significance 8

Measuring Range Selection

 Automatic 18

 Manual 18

Memory

 Clear 25

 Ending Recording 25

 Querying Occupancy 25

 Start Recording 24

O

OCCUP 54

Overview

 Keys and Connections 12

 Parameters 53

P

Power Pack

 Accessories 72

 Initial Start-Up 16

Power Pack Adapter Socket

 Position of the Connector Socket 15

Product Support 3

R

rAtE 55

Recalibration Service 4, 71

Recognition of Interference Voltage 41

Reference Junction 35

Repair and Replacement Parts Service 4

Resistance Measurement 32

Resolution, high for V DC and Ohm 55

RPM Measurement (function only available
with customer-specific variant) 31

S

Safety Precautions 8

Standard Equipment 2

Switching the Instrument On

 Manual 16

 Via PC 16

Symbols

 Device 15

 Digital Display 13

 Rotary Switch Positions 14

T

Temperature Measurement

 with Resistance Thermometers 33

 with Thermocouples 35

tiME 54, 57

Training 3

U

ur (under-range) 68

Use for Intended Purpose 10

V

vErSion 54

Voltage Comparator 29

Voltage Measurement

 Notes 26

W

WEEE Mark 15

© Gossen Metrawatt GmbH
Edited in Germany • Subject to change without notice / errors excepted • A PDF version is available on the Internet

All trademarks, registered trademarks, logos, product names, and company names are the property of their respective owners.

 **GOSSEN METRAWATT**
Gossen Metrawatt GmbH
Südwestpark 15
90449 Nürnberg • Germany

Phone +49 911 8602-0
Fax +49 911 8602-669
E-Mail info@gossenmetrawatt.com
www.gossenmetrawatt.com