

Operating instructions

SINEAX VC604s

Programmable Safety Value Converter

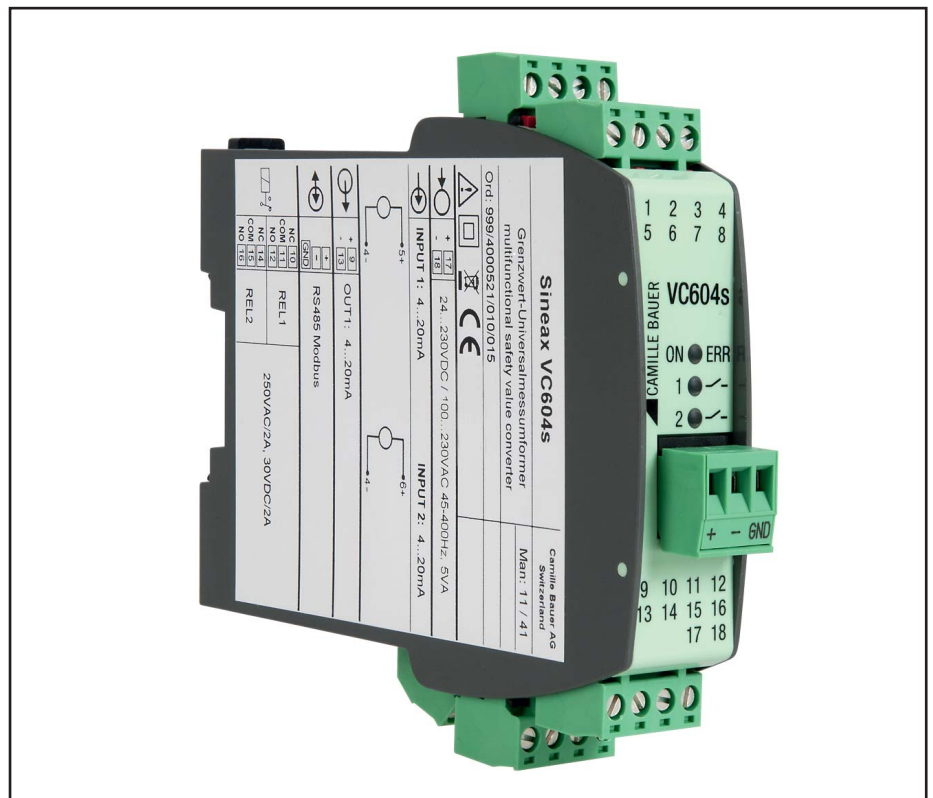

VC604s Be

Version 02

09.13

Camille Bauer AG
Aargauerstrasse 7
CH-5610 Wohlen/Switzerland
Phone +41 56 618 21 11
Fax +41 56 618 21 21
info@camillebauer.com
www.camillebauer.com

 CAMILLE BAUER

Operating instructions

Programmable multifunctional transmitter SINEAX VC604s

First read, then ...

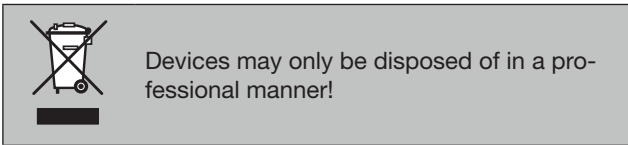
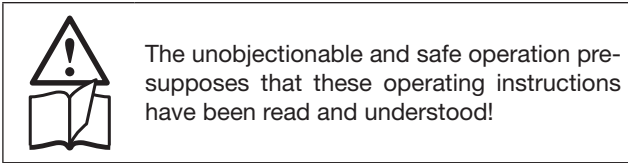

Contents

1. Functional description	2
2. Connection to a PC and communication via CB-Manager	2
3. Block diagram.....	3
4. Technical data.....	4
5. Signal flow	7
6. Modbus interface.....	10
6.1 EIA-RS-485 Standard.....	10
6.2 Coding and addressing	10
6.3 Mapping	11
6.4 Device identification	11
6.5 Measured values	12
6.6 Configuration parameters.....	13
7. Electric connections	20
8. Dimensional drawing	21
9. Accessories	21
10. Conformity declaration	22

1. Functional description

VC604s is a multifunctional transmitter for top-hat rail assembly with the following main characteristics:

- Measurement of DC voltage, DC current, temperature (RTD, TC) and resistance
- Sensor connection without any external jumpers
- 2 inputs (e.g. for sensor redundancy or difference formation)
- 1 output (U or I)
- 2 inputs can be linked with each other and allocated to the 2 outputs which enables calculations and sensor monitoring (e.g. prognostic maintenance of sensors)
- System capability: Communication via Modbus interface
- 2 freely programmable relays with changeover contacts, e.g. for limit or alarm signalling
- AC/DC wide-range power supply unit
- Pluggable high-quality screw or spring cage terminals

All settings of the instrument can be adapted to the measuring task by PC software. The software also serves visualising, commissioning and service.

2. Connection of SINEAX VC604s to a PC and communication via CB-Manager.

VC 604s communicates with a PC (CB-Manager) via an RS 232/RS485 interface and a MODBUS protocol.

Select the following settings in this respect:

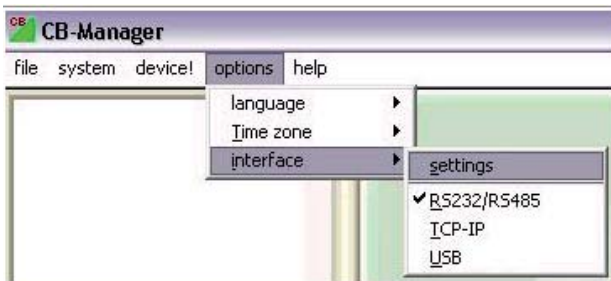

Select the RS 232/ RS485 interface under Options / Interface.

This is also applicable if an RS485/USB converter is used and the converter is connected to the computer via the USB connection.

Subsequently, enter the following settings under Options / Interface / Settings:

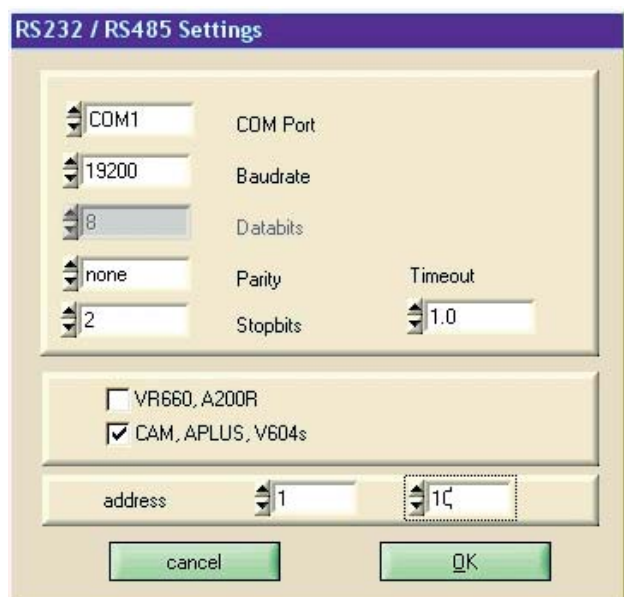

The existing COM ports are determined as the communication interface when starting the program and selecting RS232/RS485. Only COM ports found are available for selection.

Limiting the range of possible device addresses speeds up the search of connected devices considerably.
 Example: If only 2 devices are connected, it makes sense to select the address range from 1 to 2.

All settings are stored as the program is terminated. If the COM port is not available upon the next start of the program (e.g. because the converter has not been plugged in) another valid interface is set.

To determine which COM port has been allocated to the RS485 converter (if required), please proceed as follows:

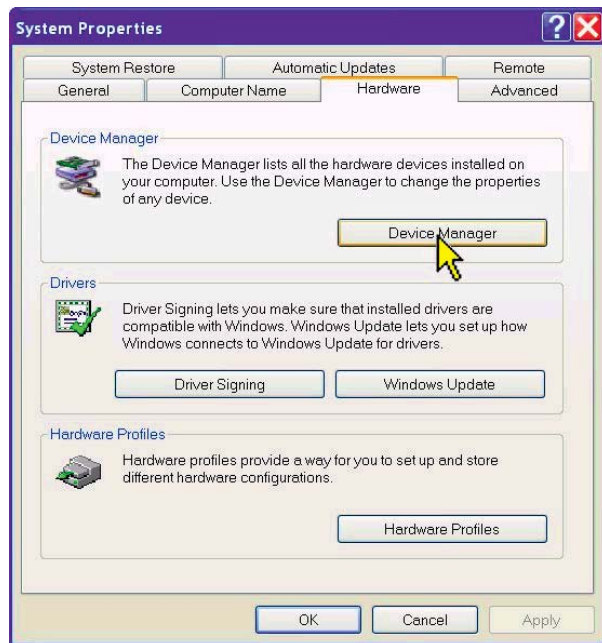

The COM port of an external RS232 or RS485 converter may be determined (and, if required, changed) via the Windows system control.

Example for Windows XP: **System control => System**



This example shows the COM ports of a PCMCIA card and a USB-RS232 converter:

- Silicom Serial Card: COM1
- USB-RS232 adapter: COM4

If you use the Camille Bauer USB-RS485 converter (Article Number 163189), the same is to be connected as follows:

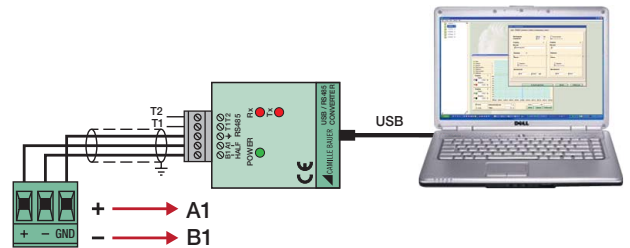

3. Block diagram

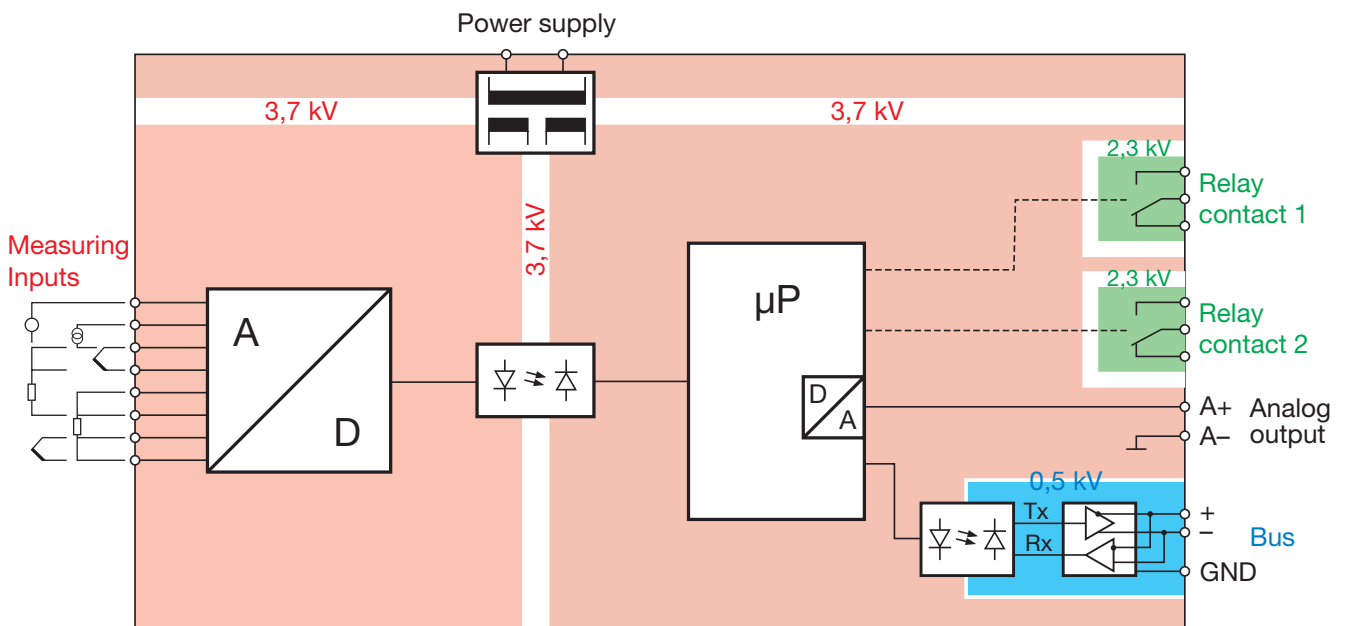

4. Technical data

Table 1: Input variables, measuring ranges

Measurement type	Measuring range	Minimum span
DC voltage [mV]	-1000 ... 1000 mV	2 mV
DC voltage [V]	-300 ... 300 V	>1 V
DC current [mA]	-50 ... 50 mA	0,2 mA
Resistance [Ω]	0 ... 5000 Ω	8 Ω
RTD Pt100	-200 ... 850 °C	20 K
RTD Ni100	-60 ... 250 °C	15 K
TC Type B	0 ... 1820 °C	635 K
TC Type E	-270 ... 1000 °C	34 K
TC Type J	-210 ... 1200 °C	39 K
TC Type K	-270 ... 1372 °C	50 K
TC Type L	-200 ... 900 °C	38 K
TC Type N	-270 ... 1300 °C	74 K
TC Type R	-50 ... 1768 °C	259 K
TC Type S	-50 ... 1768 °C	265 K
TC Type T	-270 ... 400 °C	50 K
TC Type U	-200 ... 600 °C	49 K
TC TypeW5Re-26Re	0 ... 2315 °C	135 K
TC TypeW3Re-25Re	0 ... 2315 °C	161 K

Measuring input 1

Direct voltage

Measuring range mV For limits see Table 1
 $R_i > 10 \text{ M}\Omega$, continuous,
 overload max. $\pm 1200 \text{ mV}$

Measuring range V For limits see Table 1
 (only in corresponding device type)
 $R_i = 1.4 \text{ M}\Omega$, continuous,
 overload max. $\pm 300 \text{ V}$

Direct current

Measuring range mA For limits see Table 1
 $R_i = 11 \Omega$, continuous,
 overload max. $\pm 50 \text{ mA}$

Resistance thermometer RTD

Resistance measurement types Pt100 (IEC 60751), adjustable Pt20...Pt1000 Ni100 (DIN 43760), adjustable Ni50...Ni1000

Measuring range limits See Table 1

Wiring 2, 3 or 4-wire connection

Measuring current 0.2 mA

Line resistance 30 Ω per line, in 2-wire connection adjustable or calibratable

Thermocouples TC

Thermocouples Type B, E, J, K, N, R, S, T (IEC 60584-1) Type L, U (DIN 43760) Type W5Re-W26Re, W3Re-W25Re (ASTM E988-90)

Measuring range limits See Table 1

Cold junction compensation Internal (with installed Pt100), with Pt100 on terminals, external with reference junction thermostat $-20 \dots 70 \text{ }^\circ\text{C}$

Resistance measurement, teletransmitter, potentiometer

Measuring range limits See Table 1

Wiring 2, 3 or 4-wire connection

Resistance teletransm. Type WF and WF DIN

Measuring current 0.2 mA

Line resistance 30 Ω per line, in 2-wire connection adjustable or calibratable

Measuring input 2

Direct current

Measuring range mA Same as Measuring input 1

Direct voltage

Measuring range mV Same as Measuring input 1

Resistance thermometer RTD

Same as Measuring input 1 except:
 Wiring 2 or 3-wire connection

Thermocouples TC

Same as Measuring input 1

Resistance measurement, teletransmitter, potentiometer

Same as Measuring input 1 except:
 Wiring 2 or 3-wire connection

Please note:

The following device types are available:

a) VC604s with measuring input for 1x direct current [mA] and 1x high direct voltage [V]

The direct voltage [V] and direct current [mA] measuring methods can be allocated to Input 1 or Input 2 here.

b) VC604s with measuring input for 2x direct current [mA]

The different device types are firm and cannot be reprogrammed!



Measuring inputs 1 and 2 are galvanically connected. If 2 input sensors or input variables are used, observe combination options in Table 3 (page 21) and circuit instructions (page 20)!

Analog output

The two outputs are galvanically connected and have a common earth. Voltage and current output software-configurable.

Direct current

Output range $\pm 20 \text{ mA}$, range may be freely set

Burden voltage max. 12 V

Open circuit voltage < 18 V

Limit Adjustable, max. $\pm 22 \text{ mA}$

Residual ripple < 50 $\mu\text{A pp}$ (after low pass 10 kHz)

Source resistance > 5 $\text{M}\Omega$

Direct Voltage

Output range	$\pm 10\text{ V}$, range may be freely set
Load	max. 20 mA
Current limit	Approx. 30 mA
Limit	Adjustable, max. $\pm 11\text{ V}$
Residual ripple	$<20\text{ mV pp}$ (after low pass 10 kHz)
Source resistance	$<2\ \Omega$

Output settings

Limit
Gain/offset trimming
Inversion

Relay contact outputs

Contact	1 pole, changeover contact
Switching capacity	AC: 2 A / 250 V DC: 2 A / 30 V

Bus/programming connection

Interface, protocol	RS-485, Modbus RTU
Baudrate	9,6...115,2 kBaud, adjustable

Transmission behaviour

Measured variables for the outputs

- Input 1
- Input 2
- Input 1 + Input 2
- Input 1 – Input 2
- Input 2 – Input 1
- Input 1 · Input 2
- Minimum value, maximum value
or mean value of Input 1
and Input 2
- Sensor redundancy
Input 1 or Input 2

Transmission functions Linear, Absolute amount, scaling (gain/ offset), magnifier function (zoom)
user-specific via basic value table (24 basic values per measured variable)

Settling time: Adjustable 1...30 s

Limit values and monitoring

Number of limit values 4

Measured variables for limit values

- Input 1
- Input 2
- Measured variable for outputs
- Input 1 – Input 2
(e.g. drift monitoring in case of 2 sensors)
- Input 2 – Input 1
(e.g. drift monitoring in case of 2 sensors)

Functions Absolute amount
Gradient dx/dt (e.g. temperature gradient monitoring)

Time delay Adjustable 0...3600 s

Signaling Relay contact, alarm LED, Status 1

Sensor breakage and short circuit monitoring measuring input

Signalling	Relay contact, alarm LED, Status 1 Output value in case of a fault
Signalling to alarm LED	In case of a sensor error, the defective input (1 or 2) is signalled by the number of flashes of the alarm LED (1x or 2x). In case of a failure at both inputs: Alarm LED does not flash.

Other monitoring operations

Drift monitoring	Monitoring of measured value between 2 input sensors for a certain period of time (e.g. due to different sensor response times). If this time is exceeded, an alarm is signalled. (See Limit values 1 and 2)
Sensor redundancy	Measurement with 2 temperature sensors; if Sensor 1 fails (fault) Sensor 2 is activated for bridging (see measuring variable for outputs).

Alarm signalling

Time delay	Adjustable 0...60 s
Alarm LED "ERR"	
Relay contact	When the relay is activated, the yellow LED shines, invertible alarmfunction
Output value in case of a fault	For sensor breakage and short circuit, value adjustable $-10...110\%$



Power supply

Rated voltage UN	Tolerance
24...230 V DC *	$\pm 15\%$
100...230 V AC, 45...400 Hz	$\pm 15\%$

* In case of a power supply voltage $>125\text{ V DC}$, the power supply circuit must contain an external fuse.

Power consumption $<3\text{ W}$ bzw. 7 VA

Displays at the instrument

LED	Color	Function
ON/ERR	green	Power on
	red	Alarm
	green flashing	Communication activ
1 	yellow	Relay 1 on
2 	yellow	Relay 2 on

Configuration, programming

Operation with PC software «CB-Manager»

Accuracies (according to EN/IEC 60770-1)

Reference conditions

Ambient temperature	23 °C ± 2 K
Power supply	24 V DC
Reference value	Span
Settings	Input 1: Direct voltage mV, 0...1000 mV Output 1: 4...20 mA, burden resistance 300 Ω Mains frequency 50 Hz, Setting time 1 s Input 2, output 2, relay, monitoring off or not active
Installation position	Vertically, detached

Basic accuracy

At reference conditions	±0.1%
<i>Other types of measurement and input ranges:</i>	
RTD Pt100, Ni100	±0.1% ±0.2 K
Resistance measurement	±0.1% ±0.1 Ω
TC Type K, E, J, T, N, L, U	±0.1% ±0.4 K, measurement value > -100 °C
TC Type R, S	±0.1% ±2.4 K
TC Type B	±0.1% ±2.4 K, measurement value > 300°C
TC W5Re-W26Re, W3Re-W25Re	±0.1% ±2.0 K
DC voltage mV	±0.1% ±0.015 mV
DC voltage V	±0.1% ±0.0045 V
DC current mA	±0.1% ±0.0015 mA

Additional error (additive)

High range minimum value (Minimum value >40% of maximum value):	±0.1% of maximum value
Small output range	±0.1% * (reference range / new range)
Cold junction compensation internal	typical ±3 K
Magnifier function	± Zoom factor x (basic accuracy + additional error) Zoom factor = measured variable range / zoom range

Influencing factors

Ambient temperature	±0.1% per 10 K at reference conditions other settings: basic accuracy and additional errors per 10 K
Long-term drift	±0.1%
Common mode influence	±0.01%

Ambient conditions

Operating temperature	-25 ... +55 °C
Storage temperature	-40 ... +70 °C
Relative humidity	
Annual average	≤75%, no condensation
Range of utilisation	Internal room up to 2000 m above sea level

Installation details

Design	Top-hat rail housing U4 Combustibility class V-0
--------	---

Dimensions	according to UL 94
Assembly	See dimensional drawing For snap-on fastening on top-hat rail (35 x 15 mm or 35 x 7.5 mm) according to EN 50022
Terminals	Pluggable, 2.5 mm ² Front plug spring terminal 1.5 mm ²
Weight	0.14 kg

Product safety, regulations

Electromagnetic compatibility	EN 61000-6-2 / 61000-6-4
Ingress protection (acc. IEC 529 or EN 60529)	Housing IP 40 terminal IP20
Electric design	Acc. IEC or EN 61010
Degree of pollution	2
Between power supply and all circuits and between the measuring input (1 + 2) and all circuits	Reinforced insulation overvoltage category III Working voltage 300 V Test voltage 3.7 kV AC rms
Between output (1 + 2) and relay contact	Reinforced insulation overvoltage category II Working voltage 300 V Test voltage 2.3 kV AC rms
Between output (1 + 2) and the bus connection	Functional insulation Working voltage <50 V Test voltage 0.5 kV AC rms
Environmental tests	EN 60068-2-1/-2/-3 EN 60068-2-27 Shock: 50g, 11ms, sawtooth, half-sine EN 60068-2-6 Vibration: 0.15mm/2g, 10...150Hz, 10 cycles

Type label

Sineax VC604s		Camille Bauer AG Switzerland
Grenzwert-Universalmessumformer multifunctional safety value converter		Man: 12 / 7 NLB: XXXX
Ord: 999/123456/999/001		
		250VAC/2A, 30VDC/2A

Explanation of symbols on the type label

Symbol	Meaning
	Double insulation, device of protection class 2
	CE conformity mark. The device fulfills the requirements of the applicable EG directives
	Caution! General hazard point. Read the operating instructions.
	The instruments must be only be disposed of in the correct way!
	General symbol: Input
	General symbol: Output
	General symbol: Power supply
	General symbol: Communication
	General symbol: Relay

5 Signal flow

The following diagram shows the VC604s signal flow. All relevant measured variables and parameters determining the signal flow are represented.

Overview signal flow

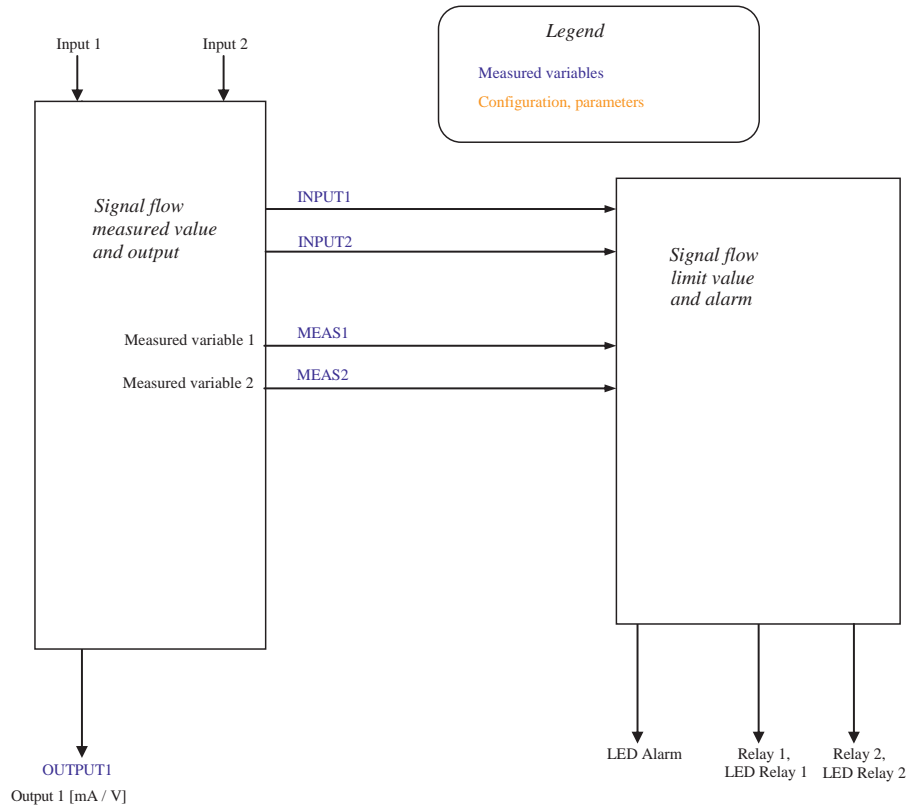

Signal flow measured value and output

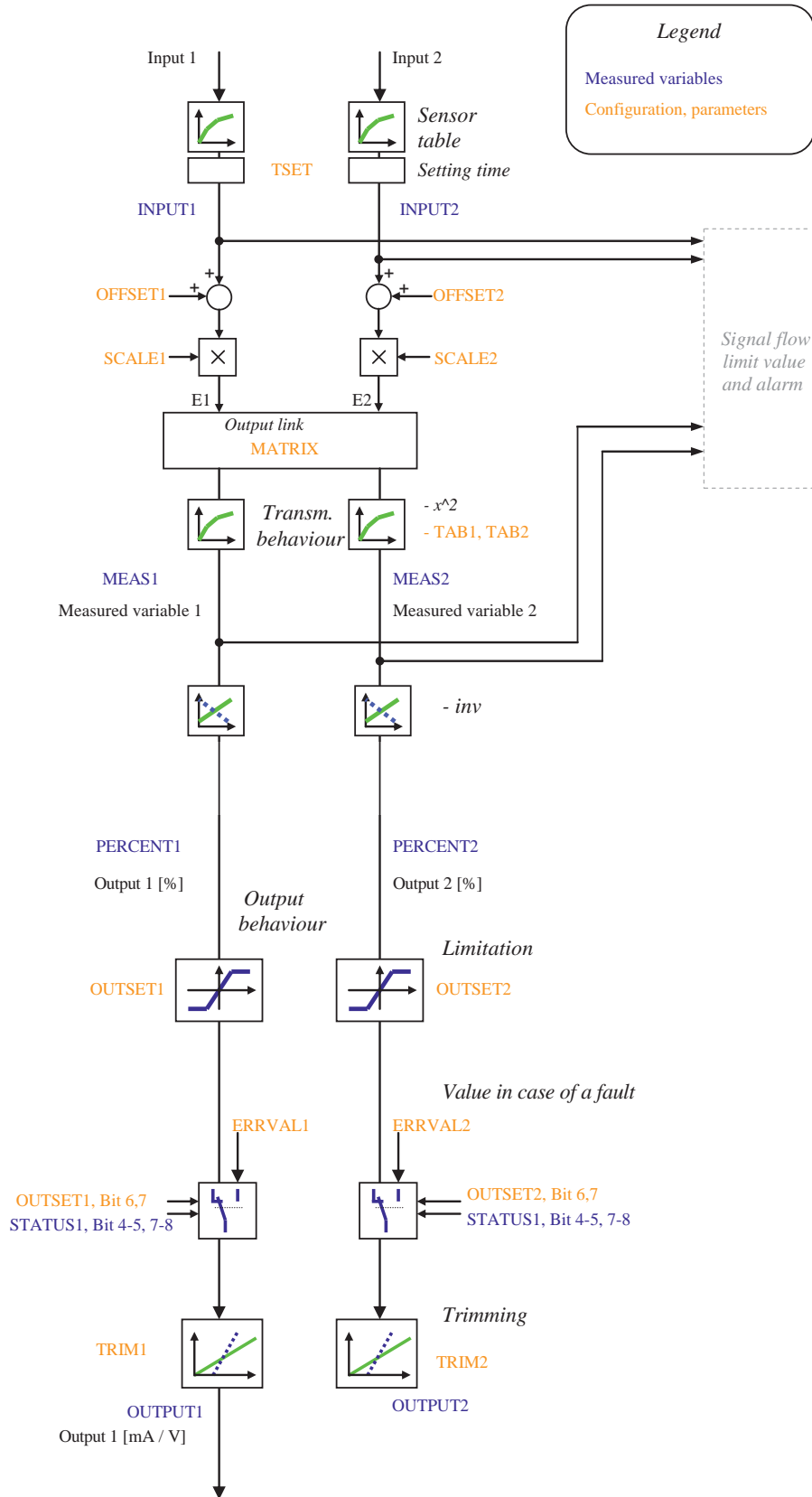

Signal flow limit value and alarm

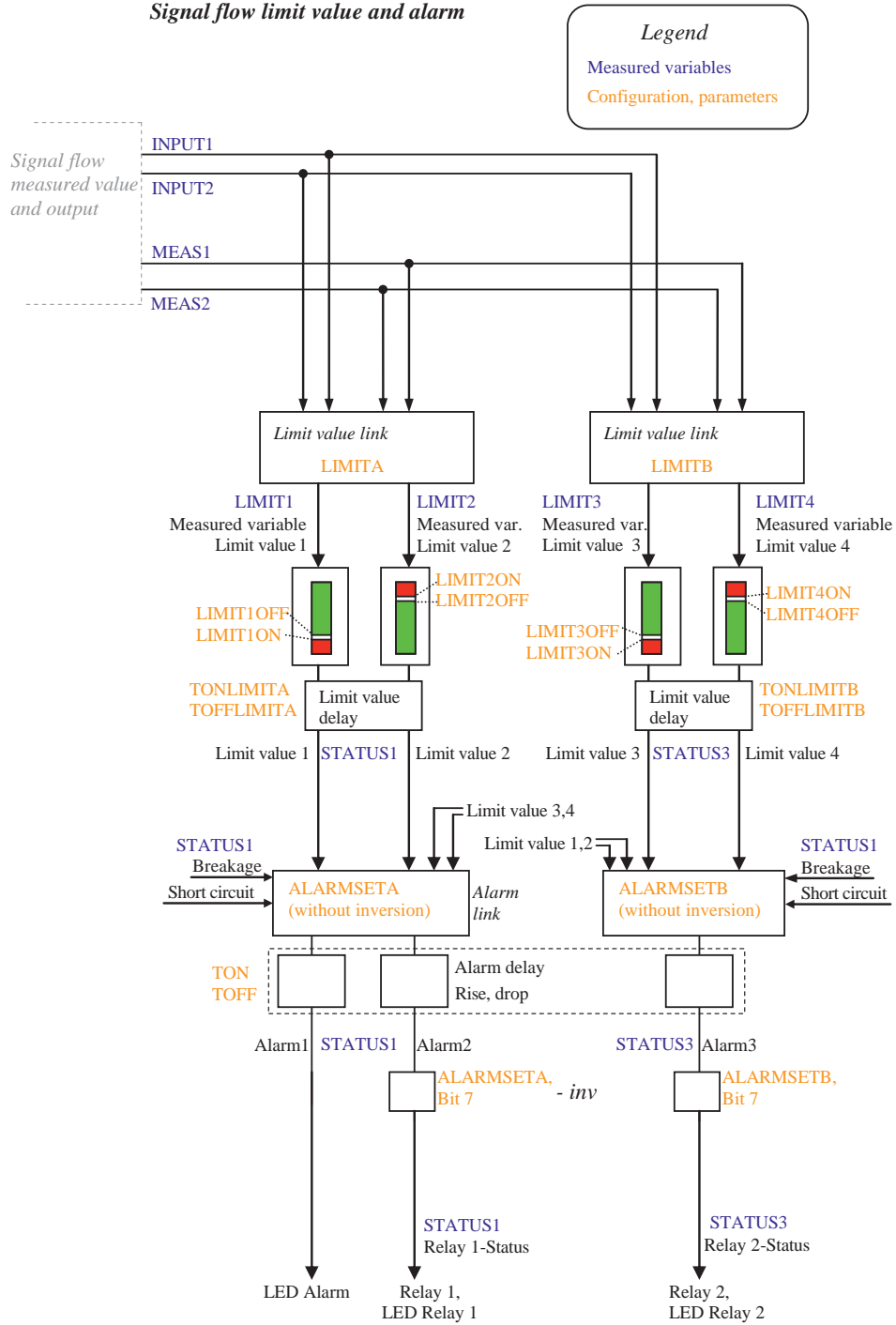

6. Modbus interface

6.1 EIA-RS-485 Standard

The EIA-RS-485 standard defines the physical layer of the Modbus interface.

Coding

The data is transmitted in serial form via the 2-wire bus. The information is coded as a difference signal in the NRZ code. Positive polarity signals a logic 1, negative polarity signals the logic 0.

Connections

A shielded, twisted, 2-conductor cable should be used as a bus cable. Shielding serves improved electromagnetic compatibility (EMC). Depending on the source of information, the description of Conductor A and B is contradictory.

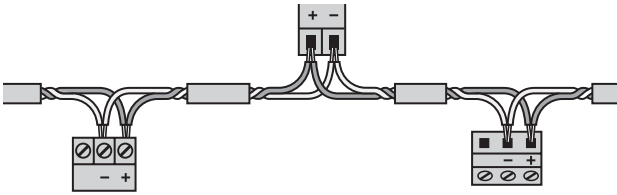

The potential difference of all bus participants may not exceed $\pm 7V$. Therefore, the use of a shield or a third conductor (ref line) is recommended to create potential equalisation.

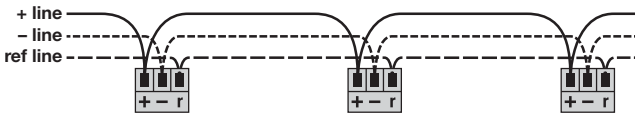

Topology

Both ends of the bus cable must be equipped with a line terminator. Supplementing the line termination resistance R_T of the EIA-RS-485 standard an additional resistance R_U (pull-up) must be wired against the supply voltage and a resistance R_D (pulldown) against the reference potential. These two resistances ensure a defined idle potential on the line when none of the participants is sending.

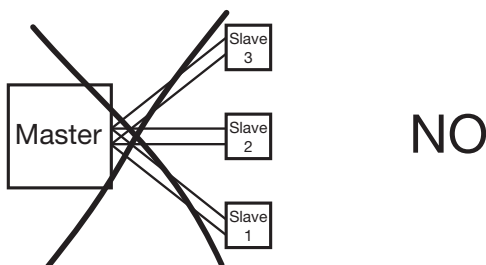
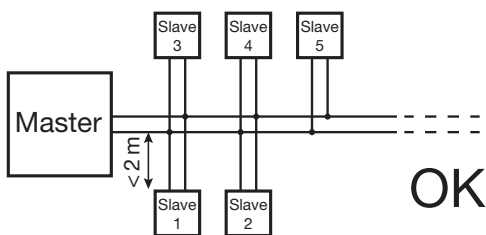
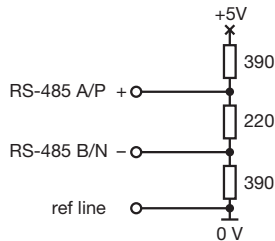

System requirements

Cable:	Twisted, 2-wire line, wave resistance 100 to 130 Ω , min. 0.22mm ² (24AWG)
Line length:	Maximum 1'200m depending on the transmission rate
Participants:	Maximum 32 per segment
Rate:	9'600, 14'400, 19'200, 38'400, 56'000, 57'600, 115'200 Baud
Mode:	11 bit format - 2 stop bit without parity or 1 stop bit with even/uneven parity

6.2 Coding and addressing

Addressing

In the telegram, all data addresses refer to zero. The first data element is always addressed via the 0 address. For example, the coil which is known as "Coil 1" in the device, is addressed as "Coil 0" in the telegram. Coil 127 is addressed as 0x007E.

Holding register 40001 is addressed as Register 0 in the telegram. The function code of the telegram already states that a "holding register" is concerned. Consequently, the reference to "4XXXX" is implicit.

Holding register 40108 is addressed as 0x006B (107 decimal).

Serialisation

The specification defines the telegrams as byte sequences. The respective physical layer (RS485, Ethernet) is responsible for the correct serialisation of the bytes (MSB or LSB First). RS485 (UART, COM) transmits the "Least Significant Bit" first (LSB First) and adds the synchronisation and backup bits (start bit, parity bit and stop bit).

Start	1	2	3	4	5	6	7	8	Par	Stop
-------	---	---	---	---	---	---	---	---	-----	------

Bits

Bits are represented within a byte in a conventional manner with the MSB (Bit 7) leftmost and the LSB (Bit 0) rightmost (0101'1010 = 0x5A = 90). An example for the inquiry of Coils 20 to 40 of Slaves 17.

Byte	Inquiry		Response	
0	Slave address	0x11	Slave address	0x11
1	Function code	0x01	Function code	0x01
2	Start address	0x00	Byte count	0x03
3	19 = Coil 20	0x13	Byte 0	0xCD
4	Number	0x00	Byte 1	0x6B
5	20...40 = 21	0x15	Byte 2	0x01

The start address in the inquiry plus the bit position in response byte 0 corresponds to the coil address. Commenced bytes are completed with zeros. Coil 27...20 = 0xCD = 11001101b \rightarrow Coil20 = ON, Coil21 = OFF, Coil22 = ON, etc.

Bytes

Modbus does not know a byte or character data type (see address space). Strings or byte arrays are mapped in "holding registers" (2 characters per register) and transmitted as a "character stream", e.g. "Hello_World".

Register	HEX	char	Register	HEX	char
40101	0x4865	,H' ,e'	40104	0x576F	,W' ,o'
40102	0x6C6C	,l' ,l'	40105	0x726C	,r' ,l'
40103	0x6F5F	,o' ,_'	40106	0x6400	,d' ,'

Words

Registers or words are transmitted according to specification in "Big Endian" format, e.g. Read Holding Register 40101 of Slave 17.

Real

Modbus does not know any data types to represent floating point numbers. On principle, any data structures may be mapped on the 16Bit register ("cast"). The IEEE 754 standard is the most used standard to represent floating point numbers.

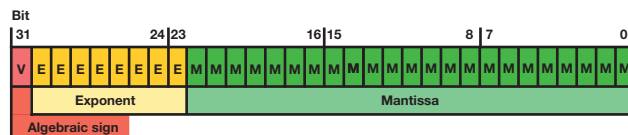

The first register contains Bits 15 – 0 of the 32-bit number (bit 0...15 of the mantissa).

The second register contains Bits 16 – 32 of the 32-bit number (algebraic sign, exponent and Bit 16- 22 of the mantissa).

6.3 Mapping

Address space

The address space may be divided into 4 address spaces according to the 4 types of data.

Space	r/w	Address area	Function code
Coil	Readable Writeable	00001 - 09999	0x01 Read Coil Status ¹⁾
			0x05 Force Single Coil ¹⁾
			0x0F Force Multiple Coils ¹⁾
Discrete input	Only readable	10001 - 19999	0x02 Read Input Status ¹⁾
Input register	Only readable	30001 - 39999	0x04 Read Input Register ¹⁾
Holding register	Readable Writeable	40001 - 49999	0x03 Read Holding Registers 0x06 Force Single Register ¹⁾ 0x10 Preset Multiple Registers

¹⁾ not implemented

To reduce the commands, the device image was represented as far as possible in "holding registers".

Segments

Address	Description	Permitted function codes
40209 - 40210	Actions	
40257 - 40289	Measured values, status	0x03 Read Holding Registers
40400 - 40402	Reserved	0x10 Preset Multiple Registers
40515 - 40516	Settings (Modbus)	
40517 - 40792	Configuration data	
41076	Device type	0x03 Read Holding Registers

Syntax

Address	Start address of the described data block (register, coil or input status)
Description	Unique variable or structure description
Data type	Data type of variable (U: unsigned, INT: integer, 8/16/32 bit, REAL or CHAR[.])
#	Offset from the start address in the data type unit, for Byte 0: Low, 1: High byte
Default	Value upon delivery or after a hardware reset
Description	Exact details concerning the variable described

6.4 Device identification

The device is identified by "Read Slave ID".

Function 11h: Report Slave ID

Master telegram:

Device address	Function	CRC
ADDR	0x11	LO HI

Slave telegram:

Device Address	Function	Number data bytes	Slave ID	Sub ID	Data 2	CRC
ADDR	0x11	3				LO HI

Device ID	Sub-ID	Device	Description
0x01	0x00	VR660	Temperature controller
0x02	0x00	A200R	Display
0x03	0x01	CAM	Universal measuring unit for heavy current variables
0x04	0x00	APLUS	Multifunctional display
0x05	0x00	V604s	Universal transmitter
0x05	0x01	VB604s	Universal transmitter multi in/out
0x05	0x02	VC604s	Universal transmitter second relay
0x05	0x03	VQ604s	Universal transmitter fast setting time

Device information

Adress	Description	Data type	Description
41076	DEVICE	UINT16	Device type
			Bit Description
			0 Reserved
			1 Reserved
			2 0: V / mA inputs 1: 2 x mA inputs
			3-15 Reserved

6.5 Measured values

Triggering action

Address	Description	Data type	#	Default	Description				
40209	ACTION	UINT16		0	This register starts actions.				
					<i>Action Description</i>				
					18	Input 1: With short-circuited input terminals, the line calibration is realised and the measured parameters are stored in the device. This procedure is indicated by a flashing green LED.			
					19	Line calibration at Input 2 (same as Input 1)			
40210	ACTDAT				Additional information for the implementation of an action.				

Simulation of output variables

- Writing into the PERCENT1, PERCENT2, OUTPUT1, OUTPUT2 registers interrupts the signal flow to the respective variable and the desired value is specified (However, percent and output value cannot be simulated simultaneously). The status of the simulation mode can be read in the STATUS2 status register.
- The simulation mode is terminated by writing 0 into the respective bits in the STATUS2 register.

Current measured variables

Address	Description	Data type	#	Default	Description				
40257	STATUS1	UINT16		0	Status 1				
					<i>Bit Description</i>				
					0	Reserved			
					1	Reserved			
					2	Device fault			
					3	Parameter fault			
					4	Sensor breakage	Input 1		
					5	Sensor short circuit	Input 1		
					6	Reserved			
					7	Sensor breakage	Input 2		
					8	Sensor short circuit	Input 2		
					9	Reserved			
					10	Alarm 1			
					11	Alarm 2 (relay 1 status before inverting)			
					12	Limit value 1			
					13	Limit value 2			
					14	Relay 1 status			
15	Device reset or new parameter values								
40258	STATUS2	UINT16		0	Status of the simulation mode: A set bit indicates the simulation mode of the respective register.				
					<i>Bit Description</i>				
					0	Output 1 (PERCENT1)			
					1	Output 1 (OUTPUT1)			
					2	Output 2 (PERCENT2)			
3	Output 2 (OUTPUT2)								
The simulation mode is terminated by writing zeros into the respective bit positions (0..3).									
40259	INPUT1	REAL		0.0	Measured value Input 1				
40261	INPUT2	REAL		0.0	Measured value Input 2				
40263	MEAS1	REAL		0.0	Measured variable for Output 1				
40265	MEAS2	REAL		0.0	Measured variable for Output 2				
40267	LIMIT1	REAL		0.0	Measured variable for Limit value 1				
40269	LIMIT2	REAL		0.0	Measured variable for Limit value 2				
40271	T_JUNCTION1	REAL		0.0	Cold junction temperature Input 1				
40273	T_JUNCTION2	REAL		0.0	Cold junction temperature Input 2				
40275	ELAPSED	UINT32		0	Operation hour counter [s]				
40277	PERCENT1	REAL		0.0	Output 1: Scaled output variable in %				
40279	PERCENT2	REAL		0.0	Output 2: Scaled output variable in %				
40281	OUTPUT1	REAL		0.0	Output 1 [mA] / [V]				
40283	OUTPUT2	REAL		0.0	Output 2 [mA] / [V]				
40285	LIMIT3	REAL		0.0	Measured variable for Limit value 3				

6.6 Configuration parameters

Settings

Address	Description	Data type	#	Default	Description
40515	DEVADDR	UINT16		01h	MODBUS Slave address (1...247)
40516	MODBUS	UINT16		3222h	MODBUS settings
					<i>Bit Description</i>
					0-2 Baudrate
					0: 9600
					1: 14400
					2: 19200
					3: 38400
					4: 56000
					5: 57600
					6: 115200
					7: Reserved
					3 0: Odd parity
					1: Even parity
					4 0: Parity disabled
					1: Parity enabled
					5 0: 1 Stop bit
					1: 2 Stop bits
					8-15 Response delay [ms] (5..255)

Resetting of communication settings

Once the MODBUS settings have been stored in the device, communication with the device is only possible if the settings are known.

The following technique resets the MODBUS settings to the delivery status:

- Device address: 01h
- Baudrate: 19200
- Parity: None
- Stop bits: 2

A plug prepared for this purpose (Terminal + is connected to Terminal GND with a resistance of 1 kOhm) is connected to the RS485 interface before the device is switched on.

After the device has been switched on, the red LED shines for approx. 30 seconds. During this time, the green LED flashes. Subsequently, the red LED turns off (the green LED continues flashing). Within further 30 seconds, this plug has to be removed from the device.

After the successful completion of this procedure, the communication default settings are stored again in the device.

If the procedure described is not adhered to, the interface parameters are not changed.

Configuration

Address	Description	Data type	#	Default	Description
40517	DATE	UINT32		0	Configuration date (UTC time stamp in seconds starting 1.1.1970)
40519	TAG	CHAR[8]		"VC604s"0	Device text
40523	INPUT1	UINT8	0	00h at 2xmA: 40h	Type of measurement Input 1 FFh: Measurement is inactive
					Wiring variant A Terminal
					00h: Voltage measurement [mV] 3,4
					04h: Thermocouple internally compensated [K] 3,4
					60h: Thermocouple with ext. cold junction thermostat [K] 3,4
					21h: Resistance thermometer 2-wire [K] 1,4
					22h: Resistance thermometer 3-wire [K] 1,3,4
					23h: Resistance thermometer 4-wire [K] 1,2,3,4
					24h: Thermocouple with ext. Pt100 on Terminals 1-4 [K] 1,3,4
					44h: Thermocouple with ext. Pt100 on Terminals 2-8 [K] 3,4,2,8
					01h: Resistance measurement 2-wire [Ω] 1,4
					02h: Resistance measurement 3-wire [Ω] 1,3,4
					03h: Resistance measurement 4-wire [Ω] 1,2,3,4
					42h: Resistance transmitter WF [Ω] 1,3,4
					62h: Resistance transmitter WFDIN [Ω] 1,3,4
					20h: Voltage measurement [V] 6,4
					40h: Current measurement [mA] 5,4
					06h: Sensor earthed: Voltage measurement [mV] 3,4
					07h: Sensor earthed: TC internally compensated [K] 3,4
					66h: Sensor earthed: TC, ext. cold junction thermostat [K] 3,4
					27h: Sensor earthed: TC with ext. Pt100 on Terminals 1-4 [K] 1,3,4

				Wiring variant B 10h: Voltage measurement [mV] 7,8 14h: Thermocouple internally compensated [K] 7,8 70h: Thermocouple with ext. cold junction thermostat [K] 7,8 31h: Resistance thermometer 2-wire [K] 2,8 32h: Resistance thermometer 3-wire [K] 2,7,8 54h: Thermocouple with ext. Pt100 on Terminals 1-4 [K] 7,8,1,4 34h: Thermocouple with ext. Pt100 on Terminals 2-8 [K] 2,7,8 11h: Resistance measurement 2-wire [Ω] 2,8 12h: Resistance measurement 3-wire [Ω] 2,7,8 52h: Resistance teletransmitter WF [Ω] 2,7,8 72h: Resistance teletransmitter WFDIN [Ω] 2,7,8 16h: Sensor earthed: Voltage measurement [mV] 7,8 17h: Sensor earthed: TC internally compensated [K] 7,8 76h: Sensor earthed: TC, ext. cold junction thermostat [K] 7,8 50h: 2nd current input [mA] 6,4 Combination limits are separately shown in a table on page 19.																											
			1 FF	Sensor type Input 1 FFh: Linear 0: RTD Ptxxx (e.g. Pt100) 1: RTD Nixxx 2: Customer-specific characteristic curve (only with NLB) 3: TC Type B 4: TC Type E 5: TC Type J 6: TC Type K 7: TC Type L 8: TC Type N 9: TC Type R 10: TC Type S 11: TC Type T 12: TC Type U 13: TC Type W5-W26Re 14: TC Type W3-W25Re <i>Automatic parameter correction²</i>																											
40524	INPRANGE1	REAL		Measuring range Input 1 <table border="1"> <thead> <tr> <th>Variable</th> <th>Range</th> <th>Minimum span</th> </tr> </thead> <tbody> <tr> <td>U[mV]:</td> <td>± 0 mV ... 1000 mV</td> <td>2 mV</td> </tr> <tr> <td>U[V]:</td> <td>± 0 V ... 300 V</td> <td>1 V</td> </tr> <tr> <td>RTD:</td> <td>Acc. sensor limits</td> <td></td> </tr> <tr> <td>TC:</td> <td>Acc. sensor limits</td> <td></td> </tr> <tr> <td>R:</td> <td>0 ... 5000 [Ω] see special case WF, WFDIN *</td> <td>8 Ohm</td> </tr> <tr> <td>I [mA]:</td> <td>± 0 ... 50 mA</td> <td>0.2 mA</td> </tr> </tbody> </table> <i>Automatic parameter correction²</i> <table border="1"> <tr> <td>0</td> <td>0.0 at 2mA: 4.0</td> <td>Measuring range start</td> </tr> <tr> <td>1</td> <td>1000.0 at 2mA: 20.0</td> <td>Measuring range end</td> </tr> </table>	Variable	Range	Minimum span	U[mV]:	± 0 mV ... 1000 mV	2 mV	U[V]:	± 0 V ... 300 V	1 V	RTD:	Acc. sensor limits		TC:	Acc. sensor limits		R:	0 ... 5000 [Ω] see special case WF, WFDIN *	8 Ohm	I [mA]:	± 0 ... 50 mA	0.2 mA	0	0.0 at 2mA: 4.0	Measuring range start	1	1000.0 at 2mA: 20.0	Measuring range end
Variable	Range	Minimum span																													
U[mV]:	± 0 mV ... 1000 mV	2 mV																													
U[V]:	± 0 V ... 300 V	1 V																													
RTD:	Acc. sensor limits																														
TC:	Acc. sensor limits																														
R:	0 ... 5000 [Ω] see special case WF, WFDIN *	8 Ohm																													
I [mA]:	± 0 ... 50 mA	0.2 mA																													
0	0.0 at 2mA: 4.0	Measuring range start																													
1	1000.0 at 2mA: 20.0	Measuring range end																													
40528	SCALE1	REAL	1.0	Scaling factor for INPUT1																											

*** Resistance teletransmitter**

For teletransmitters the measuring range is defined by 3 resistance values

Input 2: Same as Input 1.

Parameter	Meaning
INPRANGE1, measuring range start	Ra
INPRANGE1, measuring range end	Re
SENSVAL1	Rd

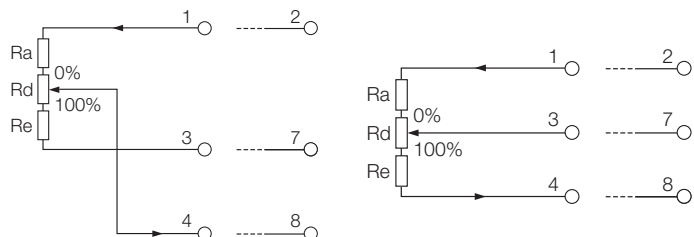

Address	Description	Data type	#	Default	Description												
40530	SENSVAL1	REAL		100.0	Input 1: Sensor value [Ω] at 0°C (e.g. 100.0 for Pt100) Pt20 ... Pt1000 Ni50 ... Ni1000 WF, WFDIN: SENSVAL1=Rd <i>Automatic parameter correction</i> ²												
40532	REF1	REAL		0.0	Reference value Input 1: – Line resistance [Ω] in 2-wire measurement: 0 ... 30 Ohm – Reference temperature in TC ext. comp.: -20 ... 70 °C <i>Automatic parameter correction</i> ²												
40534	INPUT2	UINT8	0	FFh at 2xmA: 50h	Type of measurement Input 2 (same as Input 1)												
			1	FFh	Sensor type Input 2 (same as Input 1)												
40535	INPRANGE2	REAL	Measuring range Input 2 (same as Input 1)														
			0	0.0 at 2xmA: 4.0	Measuring range start												
			1	1000.0 at 2xmA: 20.0	Measuring range end												
40539	SCALE2	REAL		1.0	Scaling factor for INPUT2												
40541	SENSVAL2	REAL		100.0	Input 2: Sensor value [Ω] at 0°C (e.g. 100.0 for Pt100) Pt20 ... Pt1000 Ni50 ... Ni1000 WF, WFDIN: SENSVAL1=Rd <i>Automatic parameter correction</i> ²												
40543	REF2	REAL		0.0	Reference value Input 2: – Line resistance [Ω] in 2-wire measurement: 0 ... 30 Ohm – Reference temperature [$^{\circ}$ C] in TC ext. comp.: -20 ... 70 °C												
40545	FREQ	REAL		50.0	System frequency [Hz]: 10 ... 100 Hz <i>Automatic parameter correction</i> ²												
40547	TSET	REAL		1.0	Settling time (99%) [s] (1 ... 30) <i>Automatic parameter correction</i> ²												
40549	SETTING	UINT16		00h	Settings <table border="1"> <thead> <tr> <th>Bit</th> <th>Description</th> </tr> </thead> <tbody> <tr> <td>0</td> <td>Recognition of the type of connection (2L, 3L, 4L) after reset</td> </tr> <tr> <td>1</td> <td>Input 1: Breakage monitoring activated</td> </tr> <tr> <td>2</td> <td>Input 2: Breakage monitoring activated</td> </tr> <tr> <td>3</td> <td>Input 1: Short circuit monitoring activated</td> </tr> <tr> <td>4</td> <td>Input 2: Short circuit monitoring activated</td> </tr> </tbody> </table>	Bit	Description	0	Recognition of the type of connection (2L, 3L, 4L) after reset	1	Input 1: Breakage monitoring activated	2	Input 2: Breakage monitoring activated	3	Input 1: Short circuit monitoring activated	4	Input 2: Short circuit monitoring activated
Bit	Description																
0	Recognition of the type of connection (2L, 3L, 4L) after reset																
1	Input 1: Breakage monitoring activated																
2	Input 2: Breakage monitoring activated																
3	Input 1: Short circuit monitoring activated																
4	Input 2: Short circuit monitoring activated																
40550	MATRIX	UINT8	Linking of inputs with outputs														
			0	01h	Output 1: 00h: Not used 01h: Input 1 02h: Input 2 03h: Input 1 + 2 04h: Input 1 – 2 05h: Input 2 – 1 06h: Input 1 * 2 07h: Minimum value (Input 1,2) 08h: Maximum value (Input 1,2) 09h: Mean value (Input 1,2) 81h: Sensor redundancy: Input 1 normally 82h: Sensor redundancy: Input 2 normally 87h: Sensor redundancy: Minimum value (Input 1,2) 88h: Sensor redundancy: Maximum value (Input 1,2) 89h: Sensor redundancy: Mean value (Input 1,2) Bit 6: Absolute value of the measured variable for the output - Only measured variables of the same unit may be linked. - Product formation: Only possible for combinations V*mV, V*mA, mA*mA, mV*mA and mV*mV. Sensor redundancy - Measured variable in case of a fault: INPUTx which does not show a fault - Limitations: - The same measuring range for both inputs - The same scaling factors (always 1.0) - No output value in case of a fault - Temperature measurement - Breakage or short circuit monitoring active												

Address	Description	Data type	#	Default	Description																						
			1	00h at 2xA: 02h	Output 2 (same as Output 1)																						
40551	LIMITA	UINT8	Setting of limit values																								
			0	0	Measured variable for Limit value 1 <hr/> <table border="0"> <thead> <tr> <th>Bit</th> <th>Description</th> </tr> </thead> <tbody> <tr> <td>0-4</td> <td>Limit value</td> </tr> <tr> <td></td> <td>0: Not used</td> </tr> <tr> <td></td> <td>1: Input 1 (INPUT1)</td> </tr> <tr> <td></td> <td>2: Input 2 (INPUT2)</td> </tr> <tr> <td></td> <td>3: Measured variable Output 1 (MEAS1)</td> </tr> <tr> <td></td> <td>4: Measured variable Output 2 (MEAS2)</td> </tr> <tr> <td></td> <td>5: Input 1 – Input 2</td> </tr> <tr> <td></td> <td>6: Input 2 – Input 1</td> </tr> <tr> <td>6</td> <td>Absolute value of measured variable for the limit value</td> </tr> <tr> <td>7</td> <td>1: Gradient dx/dt</td> </tr> </tbody> </table> Note: Drift monitoring is realised by difference calculation. Only measured variables of the same unit may be linked.	Bit	Description	0-4	Limit value		0: Not used		1: Input 1 (INPUT1)		2: Input 2 (INPUT2)		3: Measured variable Output 1 (MEAS1)		4: Measured variable Output 2 (MEAS2)		5: Input 1 – Input 2		6: Input 2 – Input 1	6	Absolute value of measured variable for the limit value	7	1: Gradient dx/dt
			Bit	Description																							
0-4	Limit value																										
	0: Not used																										
	1: Input 1 (INPUT1)																										
	2: Input 2 (INPUT2)																										
	3: Measured variable Output 1 (MEAS1)																										
	4: Measured variable Output 2 (MEAS2)																										
	5: Input 1 – Input 2																										
	6: Input 2 – Input 1																										
6	Absolute value of measured variable for the limit value																										
7	1: Gradient dx/dt																										
1	0	Measure variable for Limit value 2 (same as Limit value 1)																									
40552	ALARMSETA	UINT8	Relay and alarm (Relay 1)																								
			0	00h	Relay 1, LED relay 1 <hr/> <table border="0"> <thead> <tr> <th>Bit</th> <th>Description</th> </tr> </thead> <tbody> <tr> <td>0</td> <td>Limit value 1</td> </tr> <tr> <td>1</td> <td>Limit value 2</td> </tr> <tr> <td>2</td> <td>Sensor breakage Input 1 or 2</td> </tr> <tr> <td>3</td> <td>Sensor short circuit Input 1 or 2</td> </tr> <tr> <td>4</td> <td>Reserved</td> </tr> <tr> <td>5</td> <td>Limit value 3</td> </tr> <tr> <td>6</td> <td>Limit value 4</td> </tr> <tr> <td>7</td> <td>Inverted</td> </tr> </tbody> </table> These settings may all be combined with each other.	Bit	Description	0	Limit value 1	1	Limit value 2	2	Sensor breakage Input 1 or 2	3	Sensor short circuit Input 1 or 2	4	Reserved	5	Limit value 3	6	Limit value 4	7	Inverted				
			Bit	Description																							
0	Limit value 1																										
1	Limit value 2																										
2	Sensor breakage Input 1 or 2																										
3	Sensor short circuit Input 1 or 2																										
4	Reserved																										
5	Limit value 3																										
6	Limit value 4																										
7	Inverted																										
1	00h	Alarm1, LED ON/ERR <hr/> <table border="0"> <thead> <tr> <th>Bit</th> <th>Description</th> </tr> </thead> <tbody> <tr> <td>0</td> <td>Limit value 1</td> </tr> <tr> <td>1</td> <td>Limit value 2</td> </tr> <tr> <td>2</td> <td>Sensor breakage Input 1 or 2</td> </tr> <tr> <td>3</td> <td>Sensor short circuit Input 1 or 2</td> </tr> <tr> <td>4</td> <td>Reserved</td> </tr> <tr> <td>5</td> <td>Limit value 3</td> </tr> <tr> <td>6</td> <td>Limit value 4</td> </tr> </tbody> </table> Note: Drift monitoring is realised by difference calculation. These settings may all be combined with each other.	Bit	Description	0	Limit value 1	1	Limit value 2	2	Sensor breakage Input 1 or 2	3	Sensor short circuit Input 1 or 2	4	Reserved	5	Limit value 3	6	Limit value 4									
Bit	Description																										
0	Limit value 1																										
1	Limit value 2																										
2	Sensor breakage Input 1 or 2																										
3	Sensor short circuit Input 1 or 2																										
4	Reserved																										
5	Limit value 3																										
6	Limit value 4																										
40553	TON	REAL		0.0	Alarms rise delay [s]: 0..60																						
40555	TOFF	REAL		0.0	Alarms drop delay [s]: 0..60																						
40557	TONLIMITA	REAL		0.0	Limit values 1,2: rise delay [s]: 0..3600																						
40559	TOFFLIMITA	REAL		0.0	Limit values 1,2: drop delay [s]: 0..3600																						
40561	LIMIT1ON	REAL		0.0	Switching-on threshold Limit value 1, unit of LIMIT1																						
40563	LIMIT1OFF	REAL		0.0	Switching-off threshold Limit value 1, unit of LIMIT1																						
40565	LIMIT2ON	REAL		0.0	Switching-on threshold Limit value 2, unit of LIMIT2																						
40567	LIMIT2OFF	REAL		0.0	Switching-off threshold Limit value 2, unit of LIMIT2																						

Address	Description	Data type	#	Default	Description
40569	OUTSET1	UINT16		0001h	Output settings Output 1 <i>Bit Description</i> 0-1 Output limit 0: ± 0 mA or 0 V 1: ± 1 mA or 0.5 V 2: ± 2 mA or 1 V 3: $-0.2/+0.5$ mA or $-0.1/+0.25$ V (e.g. 3.8 mA ... 20.5 mA) 2 Signal flow 0: Interrupted 1: Activated 3 Output configuration 0: Current output 1: Voltage output 4 Inverting 0: normal , 1: inverted 5 Table 0: without , 1: with table 6-7 Output in case of a fault 0: PERCENTx , 1: ERRVALx in case of fault Input 1 2: ERRVALx in case of fault Input 2 3: ERRVALx in case of fault Input 1 or 2 8-15 Transmission function 0: User-defined 1: Linear 2: Quadratic 3: Volume of a horizontal cylinder
40570	OUTRANGE1	REAL			Output range Output 1 <i>Automatic parameter correction²</i>
			0	4.0	Minimum value $-20 \dots 20$ [mA] / $-10 \dots 10$ [V]
			1	20.0	Maximum value $-20 \dots 20$ [mA] / $-10 \dots 10$ [V]
40574	TRIM1	REAL			Output trimming Output 1 <i>Automatic parameter correction²</i>
			0	0.0	Offset trimming [in % of the output range, setting range $\pm 10\%$] ¹
			1	100.0	Gain trimming [in % of the output range, setting range 90...110%] ¹
40578	ERRVAL1	REAL		0.0	Output value Output 1 in case of a fault [in % of the output range, setting range $-10 \dots +110\%$] ¹
40580	OUTSET2	UINT16		001h	Output settings Output 2 (same as Output 1)
40581	OUTRANGE2	REAL			Output range Output 2
			0	4.0	Minimum value $-20 \dots 20$ [mA] / $-10 \dots 10$ [V]
			1	20.0	Maximum value $-20 \dots 20$ [mA] / $-10 \dots 10$ [V]
40585	TRIM2	REAL			Output trimming Output 2
			0	0.0	Offset trimming [in % of the output range, setting range $\pm 10\%$] ¹
			1	100.0	Gain trimming [in % of the output range, setting range 90...110%] ¹
40589	ERRVAL2	REAL		0.0	Output value Output 2 in case of a fault [in % of the output range, setting range $-10 \dots +110\%$] ¹
40591	GRAD_TIME	REAL		1.0	Time span between two measured values for gradient calculation of limit values in seconds Range: 4 x TSET ... 26210 s <i>Automatic parameter correction²</i>
40593	NUMTAB	UINT8			Number of table values
			0	0	Number of table values Table 1 <i>Automatic parameter correction²</i>
			1	0	Number of table values Table 2 <i>Automatic parameter correction²</i>
40594	TAB1_YA	REAL		-10.0	Table 1: Y-value (-10%) in % of the measuring range

Address	Description	Data type	#	Default	Description
40596	TAB1_X	REAL[20]		0.0	Table 1: X-values in % of the measuring range
40636	TAB1_Y	REAL[20]		0.0	Table 1: Y-values in % of the measuring range
40676	TAB1_YE	REAL		110.0	Table 1: Y-value (110%) in % of the measuring range
40678	TAB2_YA	REAL		-10.0	Tabelle 1: Y-Wert (-10%) in % vom Messbereich
40680	TAB2_X	REAL[20]		0.0	Tabelle 1: X-Werte in % vom Messbereich
40720	TAB2_Y	REAL[20]		0.0	Tabelle 1: Y-Werte in % vom Messbereich
40760	TAB2_YE	REAL		110.0	Tabelle 1: Y-Wert (110%) in % vom Messbereich
40762	LIMITB	UINT8	Setting of limit values		
			0	0	Measured variable for Limit value 3 <i>Bit Description</i>
			1	0	Measure variable for Limit value 4 (same as Limit value 3)
40763	ALARMSETB	UINT8	Relay and alarm (Relay 2)		
			0	00h	Relay 2, LED relay 2 <i>Bit Description</i>
			These settings may all be combined with each other.		
40764	TONLIMITB	REAL		0.0	Limit values 3, 4: rise delay [s]: 0..3600
40766	TOFFLIMITB	REAL		0.0	Limit values 3, 4: drop delay [s]: 0..3600
40768	LIMIT3ON	REAL		0.0	Switching-on threshold Limit value 3, unit of LIMIT3
40770	LIMIT3OFF	REAL		0.0	Switching-off threshold Limit value 3, unit of LIMIT3
40772	LIMIT4ON	REAL		0.0	Switching-on threshold Limit value 4, unit of LIMIT4
40774	LIMIT4OFF	REAL		0.0	Switching-off threshold Limit value 4, unit of LIMIT4
40776	OFFSET1	REAL		0.0	Offset value for INPUT1, same unit as INPUT1
40778	MEASRANGE1	REAL	Measured value range for output 1 in % of the largest possible measured variable range		
			0	0.0	Measured variable range minimum [%]
			1	100.0	Measured variable range maximum [%] - Requirement: Minimum < maximum
40782	OFFSET2	REAL		0.0	Offset value for INPUT2, same unit as INPUT2
40784	MEASRANGE2	REAL	Measured value range for output 2 in % of the largest possible measured variable range		
			0	0.0	Measured variable range minimum [%]
			1	100.0	Measured variable range maximum [%] - Requirement: Minimum < maximum
40788 to 40792	Reserved	--		--	Reserved

¹ Max. +/-22 mA or +/-11 V

² Automatic correction of parameters in the device.

Each parameter must range within permitted limits. These partly depend on other parameters.

If parameters determining the limits of dependent parameters are changed,

(e.g. measuring range is dependent on the type of measurement), the respective parameters are automatically limited to the permitted parameters. The status will show that such a correction has taken place.

Limitations of configuration parameters

Options to combine types of measurement

Register: 40523, 40534

The numerous types of measurement can be combined with each other in different ways.

See Table 3 p. 21

The "earthed" combination is used if both sensors are connected to each other.

Measured variable ranges

Based on linking (register MATRIX), scaling (register SCALE1, 2) and offset (OFFSET1, 2), the largest possible measured variable range is calculated from the measuring ranges (register INPRANGE1, 2). The device does this automatically.

The set measured variable range (register MEASRANGE1, 2), which must be within the calculated measured variable range (zoom function), is then mapped on the analogue output range.

The table values (register TAB1..., TAB2...) refer to the set measured value range.

Abbreviations:

k1: SCALE1 T1a...T1e: INPRANGE1
k2: SCALE2 T2a...T2e: INPRANGE2

MRmin...MRmax: Calculated, largest possible measured variable range

at $k1 \geq 0$: $\text{Min1} = (T_{1a} + \text{OFFSET1}) \times k_1$ $\text{Max1} = (T_{1e} + \text{OFFSET1}) \times k_1$

at $k2 \geq 0$: $\text{Min2} = (T_{2a} + \text{OFFSET2}) \times k_2$ $\text{Max2} = (T_{2e} + \text{OFFSET2}) \times k_2$

at $k1 < 0$: $\text{Min1} = (T_{1e} + \text{OFFSET1}) \times k_1$ $\text{Max1} = (T_{1a} + \text{OFFSET1}) \times k_1$

at $k2 < 0$: $\text{Min2} = (T_{2e} + \text{OFFSET2}) \times k_2$ $\text{Max2} = (T_{2a} + \text{OFFSET2}) \times k_2$

Matrix Linking of inputs with outputs	Measured variable range																																																														
	Minimum value MRmin	Maximum value MRmax																																																													
Input 1	Min1	Max1																																																													
Input 2	Min2	Max2																																																													
Input 1 + 2	Min1 + Min2	Max1 + Max2																																																													
Input 1 - 2	Min1 - Max2	Max1 - Min2																																																													
Input 2 - 1	Min2 - Max1	Max2 - Min1																																																													
Input 1 * 2																																																															
<table border="1"> <thead> <tr> <th colspan="2">Input 1</th> <th colspan="2">Input 2</th> </tr> <tr> <th>Min1</th> <th>Max1</th> <th>Min2</th> <th>Max2</th> </tr> </thead> <tbody> <tr> <td>≥ 0</td> <td>> 0</td> <td>≥ 0</td> <td>> 0</td> </tr> <tr> <td>< 0</td> <td>≤ 0</td> <td>≥ 0</td> <td>> 0</td> </tr> <tr> <td>< 0</td> <td>> 0</td> <td>≥ 0</td> <td>> 0</td> </tr> <tr> <td>≥ 0</td> <td>> 0</td> <td>< 0</td> <td>≤ 0</td> </tr> <tr> <td>< 0</td> <td>≤ 0</td> <td>< 0</td> <td>≤ 0</td> </tr> <tr> <td>> 0</td> <td>> 0</td> <td>< 0</td> <td>≤ 0</td> </tr> <tr> <td>≥ 0</td> <td>> 0</td> <td>< 0</td> <td>> 0</td> </tr> <tr> <td>< 0</td> <td>≤ 0</td> <td>< 0</td> <td>> 0</td> </tr> <tr> <td>< 0</td> <td>> 0</td> <td>< 0</td> <td>> 0</td> </tr> </tbody> </table>	Input 1		Input 2		Min1	Max1	Min2	Max2	≥ 0	> 0	≥ 0	> 0	< 0	≤ 0	≥ 0	> 0	< 0	> 0	≥ 0	> 0	≥ 0	> 0	< 0	≤ 0	< 0	≤ 0	< 0	≤ 0	> 0	> 0	< 0	≤ 0	≥ 0	> 0	< 0	> 0	< 0	≤ 0	< 0	> 0	< 0	> 0	< 0	> 0	<table border="1"> <tbody> <tr> <td>Min1 * Min2</td> <td>Max1 * Max2</td> </tr> <tr> <td>Min1 * Max2</td> <td>Max1 * Min2</td> </tr> <tr> <td>Min1 * Max2</td> <td>Max1 * Max2</td> </tr> <tr> <td>Min2 * Max1</td> <td>Min1 * Max2</td> </tr> <tr> <td>Max1 * Max2</td> <td>Min1 * Min2</td> </tr> <tr> <td>Max1 * Min2</td> <td>Min1 * Min2</td> </tr> <tr> <td>Max1 * Min2</td> <td>Max1 * Max2</td> </tr> <tr> <td>Min1 * Max2</td> <td>Min1 * Min2</td> </tr> <tr> <td>Min (Min1 * Max2, Min2 * Max1)</td> <td>Max (Min1 * Min2, Max1 * Max2)</td> </tr> </tbody> </table>	Min1 * Min2	Max1 * Max2	Min1 * Max2	Max1 * Min2	Min1 * Max2	Max1 * Max2	Min2 * Max1	Min1 * Max2	Max1 * Max2	Min1 * Min2	Max1 * Min2	Min1 * Min2	Max1 * Min2	Max1 * Max2	Min1 * Max2	Min1 * Min2	Min (Min1 * Max2, Min2 * Max1)	Max (Min1 * Min2, Max1 * Max2)
Input 1		Input 2																																																													
Min1	Max1	Min2	Max2																																																												
≥ 0	> 0	≥ 0	> 0																																																												
< 0	≤ 0	≥ 0	> 0																																																												
< 0	> 0	≥ 0	> 0																																																												
≥ 0	> 0	< 0	≤ 0																																																												
< 0	≤ 0	< 0	≤ 0																																																												
> 0	> 0	< 0	≤ 0																																																												
≥ 0	> 0	< 0	> 0																																																												
< 0	≤ 0	< 0	> 0																																																												
< 0	> 0	< 0	> 0																																																												
Min1 * Min2	Max1 * Max2																																																														
Min1 * Max2	Max1 * Min2																																																														
Min1 * Max2	Max1 * Max2																																																														
Min2 * Max1	Min1 * Max2																																																														
Max1 * Max2	Min1 * Min2																																																														
Max1 * Min2	Min1 * Min2																																																														
Max1 * Min2	Max1 * Max2																																																														
Min1 * Max2	Min1 * Min2																																																														
Min (Min1 * Max2, Min2 * Max1)	Max (Min1 * Min2, Max1 * Max2)																																																														
Minimum value (Input 1, 2)	Min (Min1, Min2)	Min (Max1, Max2)																																																													
Maximum value (Input 1, 2)	Max (Min1, Min2)	Max (Max1, Max2)																																																													
Mean value (Input 1, 2)	(Min1 + Min2)/2	(Max1 + Max2)/2																																																													
Sensor backup Input 1	Min1 ¹	Max1 ¹																																																													
Sensor backup Input 2	Min2 ¹	Max2 ¹																																																													

Sensor backup minimum value (Input 1, 2)	Min1 ¹	Max2 ¹
Sensor backup maximum value (Input 1, 2)	Min1 ¹	Max2 ¹
Sensor backup mean value (Input 1, 2)	Min1 ¹	Max2 ¹

$$^1 k_1 = k_2, T_{1a} = T_{2a}, T_{1e} = T_{2e}$$

Matrix= Absolute value of the measured variable -> the previously calculated values (MRmin, MRmax) are rescaled once more:

Matrix	Measured variable range	
	Minimum value MRmin	Maximum value MRmax
Absolute value of the measured variable		
At MRmin, MRmax ≥ 0	MRmin	MRmax
At MRmin < 0 , MRmax ≥ 0	0	Max (IMRmin, IMRmax)
At MRmin, MRmax < 0	IMRmax	IMRmin

Setting time

Register: 40547

The minimum setting time depends on whether both inputs are configured, on the types of measurement, on breakage and short circuit monitoring.

The following minimum setting times result for the input:

Type of measurement	Minimum setting time [ms]	Breakage monitoring	Short circuit monitoring
Voltage [mV]	315	X	-
Voltage [V]	160	-	-
Current [mA]	160	-	-
Resistance [Ω] 2L	280	X	X
Resistance [Ω] 3L, WF, WF_DIN	595	X	X
Resistance [Ω] 4L	435	X	X
Thermocouple int. comp.	475	X	-

Linearisation tables

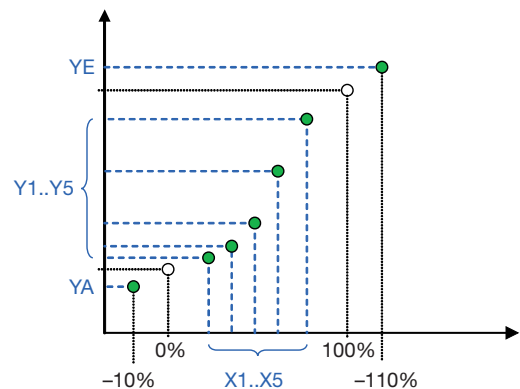

The transmission functions stored in registers OUTSET1 or OUTSET2 constitute information for the PC software to generate the desired transmission function with the table values. This information is irrelevant for the device.

Characteristic curves:

- User-defined, linear, quadratic
- Volume of a horizontal cylinder:

$$y = \frac{1}{\pi} \cdot \left[\arccos(1 - 2x) - 2 \cdot \sqrt{x - x^2} \cdot (1 - 2x) \right] \quad (h/2r = x=0..1, y=0..1)$$

7. Electric connections

Circuit	Terminals	Remarks
Measuring input	1 to 8	See Table 2, page 20/21
Output 1	9 (+), 13 (-)	
Relay contacts	nc com no	In dead voltage condition nc and com are connected
relay 1	10 11 12	
relay 2	14 15 16	
Power supply	17 (+/~) 18 (-/~)	Note polarity at DC
Bus-/programming connection	+, -, GND	Front plug

Wiring with 2 input sensors

If 2 input sensors or input variables are used, observe combination options in Table 3!



Beschaltung Eingang 1 und 2

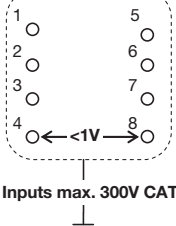

All Inputs max. 300V CATIII

If 2 input sensors or input variables are used, these must be free of potential or galvanically isolated against each other, on principle! Otherwise, the transmitter may be damaged.

Exceptions:

- In case of a permitted input combination¹ with common (and approved) connections on Terminal 4. E.g. direct voltage mV (Terminal 3, 4) & direct voltage V (Terminal 6, 4)
- In case of a permitted input combination¹ with the same reference potential (e.g. earth) on Terminal 4 and 8. E.g. 2 thermocouples (on Terminals 3, 4 or 7, 8) with earthed sensor tips or two mV inputs with a common earth potential on Terminals 4 and 8. In these cases, the specified types of measurement must be configured for earthed sensors.

¹ See Table 3 "Options to combine types of measurement" page 21

Table 2: Connections of inputs

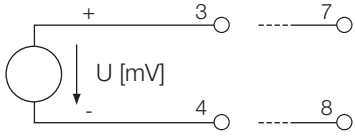
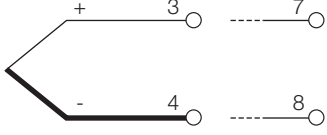
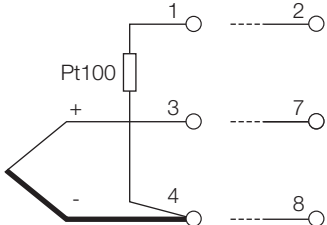
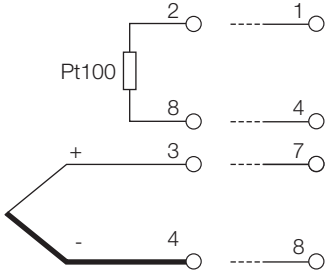
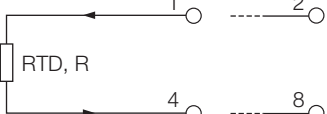
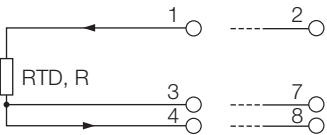
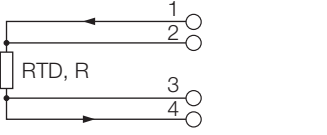
Types of measurement	Wiring	
	Input 1	Input 2
Direct voltage mV		
Thermocouple with external cold junction thermostat or internally compensated		
Thermocouple with Pt100 at the terminals at the same input		
Thermocouple with Pt100 at the terminals at the other input		
Resistance thermometer or resistance measurement 2-wire		
Resistance thermometer or resistance measurement 3-wire		
Resistance thermometer or resistance measurement 4-wire		

Types of measurement	Wiring	
	Input 1	Input 2
Resistance teletransmitter WF		
Resistance Teletransmitter WF-DIN		
Direct voltage V (only in corresponding device type)		
Direct voltage mA (Input 2 only in corresponding device type)		

Table 3: Measuring method combination options

	Input 2 measuring method	Input 1 measuring method											
		U [mV] earthed	U [V] 1	I [mA] 1	TC ext. earthed	TC int. earthed	R 2L	R 3L	RTD 2L	RTD 3L	I [mA] 2		
Terminals		7,8	6,4	5,4	7,8	7,8	2,7,8	2,8	2,7,8	2,8	2,7,8	6,4	
U [mV] earthed	3,4	✓	✓	✓	✓	✓	✓	✓	✓	✓	✓	✓	
U [V] 1	6,4	✓		✓	✓	✓	✓	✓	✓	✓	✓		
I [mA] 1	5,4	✓	✓		✓	✓	✓	✓	✓	✓	✓		
TC ext. earthed	3,4	✓	✓	✓	✓	✓	✓	✓	✓	✓	✓	✓	
TC int. earthed	3,4	✓	✓	✓	✓	✓	✓	✓	✓	✓	✓	✓	
	1,3,4	✓			✓		✓	✓	✓	✓	✓		
R 2L	1,4	✓			✓		✓	✓	✓	✓	✓		
R 3L	1,3,4	✓			✓		✓	✓	✓	✓	✓		
R 4L	1,2,3,4	✓			✓								
RTD 2L	1,4	✓			✓		✓	✓	✓	✓	✓		
RTD 3L	1,3,4	✓			✓		✓	✓	✓	✓	✓		
WF	1,3,4	✓			✓		✓	✓	✓	✓	✓		
WF_DIN	1,3,4	✓			✓		✓	✓	✓	✓	✓		
RTD 4L	1,2,3,4	✓			✓								

- 1 Selectable only in device type 1x direct current [mA] and 1x high voltage [V]
- 2 Selectable only in device type 2x direct current [mA]

8. Dimensional drawing

With screw terminals

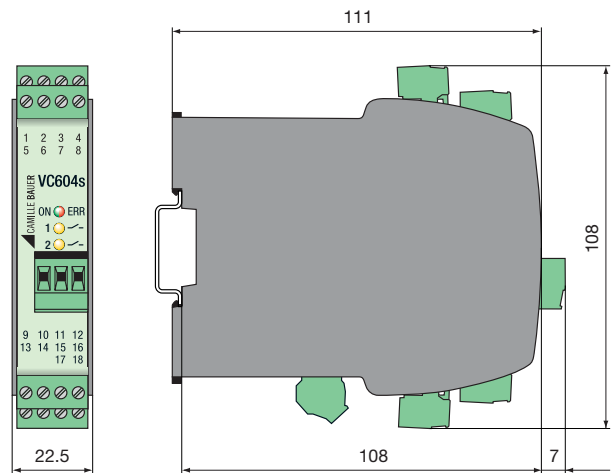

With spring cage terminals

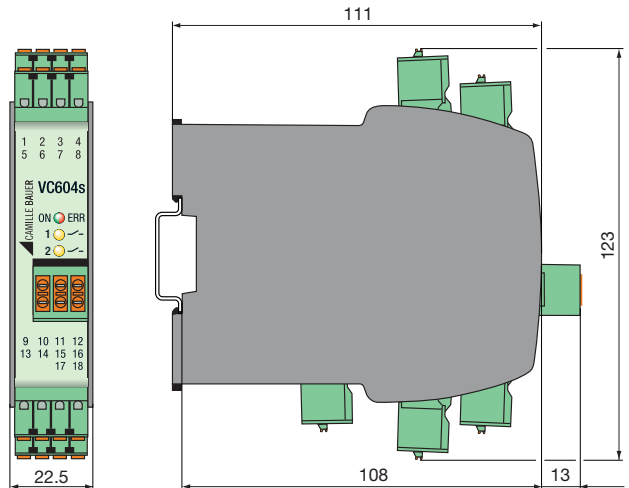

9. Accessories

USB-RS485 converter
(for SINEAX VC604s programming): Article No. 163 189

10. Conformity declaration



EG - KONFORMITÄTSERKLÄRUNG EC DECLARATION OF CONFORMITY



CAMILLE BAUER

Dokument-Nr./ Document.No.: VC604s_CE-konf.DOC

Hersteller/ Manufacturer: **Camille Bauer AG**
Switzerland

Anschrift / Address: **Aargauerstrasse 7**
CH-5610 Wohlen

Produktbezeichnung/ Product name: **Programmierbarer multifunktionaler Messumformer**
Programmable multifunctional transmitter

Typ / Type: **Sineax VC604s**

Das bezeichnete Produkt stimmt mit den Vorschriften folgender Europäischer Richtlinien überein, nachgewiesen durch die Einhaltung folgender Normen:

The above mentioned product has been manufactured according to the regulations of the following European directives proven through compliance with the following standards:

Nr. / No.	Richtlinie / Directive
2004/108/EG	Elektromagnetische Verträglichkeit - EMV-Richtlinie
2004/108/EC	Electromagnetic compatibility - EMC directive

EMV / EMC	Fachgrundnorm / Generic Standard	Messverfahren / Measurement methods
Störaussendung / Emission	EN 61000-6-4 : 2007	EN 55011 : 2007+A2:2007
Störfestigkeit / Immunity	EN 61000-6-2 : 2005	IEC 61000-4-2: 1995+A1:1998+A2:2001 IEC 61000-4-3: 2006+A1:2007 IEC 61000-4-4: 2004 IEC 61000-4-5: 2005 IEC 61000-4-6: 2008 IEC 61000-4-11: 2004

Nr. / No.	Richtlinie / Directive
2006/95/EG	Elektrische Betriebsmittel zur Verwendung innerhalb bestimmter Spannungsgrenzen – Niederspannungsrichtlinie – CE-Kennzeichnung : 95
2006/95/EC	Electrical equipment for use within certain voltage limits – Low Voltage Directive – Attachment of CE marking : 95

EN/Norm/Standard	IEC/Norm/Standard
EN 61010-1: 2010	IEC 61010-1: 2010

Ort, Datum / Place, date: Wohlen, 19.Januar 2012

Unterschrift / signature:

M. Ulrich
Leiter Technik / Head of engineering

J. Brem
Qualitätsmanager / Quality manager