

BETRIEBSANLEITUNG

Dreiphasen-Netzmessgerät SIRAX MT7100 / MT7150

Operating manual

Three phase meter SIRAX MT7100 / MT7150



 CAMILLE BAUER

Camille Bauer Metrawatt AG
Aargauerstrasse 7
CH-5610 Wohlen/Schweiz

Tel: +41 56 618 21 11
Fax: +41 56 618 21 21

info@cbmag.com
www.camillebauer.com

Inhaltsverzeichnis

1. Rechtliche Hinweise	2
1.1 Sicherheits und Warnhinweise	2
1.2 Qualifiziertes Personal	2
1.3 Bestimmungsgemässer Gebrauch	3
1.4 Haftungsausschluss	3
1.5 Rückmeldung	3
1.6 Reparaturen und Änderungen	3
1.7 Kalibration und Neuabgleich	3
1.8 Entsorgung	4
1.9 Rücksendung	4
2. Einleitung	3
2.1 Bestimmung des Dokuments	3
2.2 Lieferumfang	3
2.3 Weitere Unterlagen	4
3. Funktionsbeschreibung	4
4. Montage und Installation	4
5. Elektrische Anschlüsse	4
6. Technische Daten	5
7. Programmierung	9
7.1 Programmierung über Software	9
7.1.1 Konfiguration	10
7.2 Programmierung über Modbus Adress-Register	13
8. Kennzeichnung des Typenschildes	31
9. Zeichenerklärung	31
10. Masszeichnungen	31

1. Rechtliche Hinweise

1.1 Sicherheits und Warnhinweise

In diesem Dokument werden Sicherheits- und Warnhinweise verwendet, welche zur persönlichen Sicherheit und Vermeidung von Sachschäden befolgt werden müssen.



Ein Nichtbeachten führt zu Tod oder schwerer Körperverletzung.



Ein Nichtbeachten kann zu Sach- oder Personenschäden führen.



Ein Nichtbeachten kann dazu führen, dass das Gerät nicht die erwartete Funktionalität erfüllt oder beschädigt wird.



Die Installation und Inbetriebnahme darf nur durch geschultes Personal erfolgen. Überprüfen Sie vor der Inbetriebnahme, dass:

- die maximalen Werte aller Anschlüsse nicht überschritten werden, siehe Kapitel "Technische Daten",
- die Anschlussleitungen nicht beschädigt und bei der Verdrahtung spannungsfrei sind
- Energierichtung und Phasenfolge stimmen.

Das Gerät muss ausser Betrieb gesetzt werden, wenn ein gefahrloser Betrieb (z.B. sichtbare Beschädigungen) nicht mehr möglich ist. Dabei sind alle Anschlüsse abzuschalten. Das Gerät ist an unser Werk bzw. an eine durch uns autorisierte Servicestelle zu schicken.

Ein Öffnen des Gehäuses bzw. Eingriff in das Gerät ist verboten. Das Gerät hat keinen eigenen Netzschalter. Achten Sie darauf, dass beim Einbau ein gekennzeichnete(r) Schalter in der Installation vorhanden ist und dieser vom Benutzer leicht erreicht werden kann.

Bei einem Eingriff in das Gerät erlischt der Garantieanspruch.



Es ist zu beachten, dass die auf dem Typenschild angegebenen Daten eingehalten werden!

Es sind die landesüblichen Vorschriften bei der Installation und Auswahl des Materials der elektrischen Leitungen zu befolgen!

1.2 Qualifiziertes Personal

Das in diesem Dokument beschriebene Produkt darf nur von Personal gehandhabt werden, welches für die jeweilige Aufgabenstellung qualifiziert ist. Qualifiziertes Personal hat die Ausbildung und Erfahrung um Risiken und Gefährdungen im Umgang mit dem Produkt erkennen zu können. Es ist in der Lage die enthaltenen Sicherheits- und Warnhinweise zu verstehen und zu befolgen.

1.3 Bestimmungsgemässer Gebrauch

Das in diesem Dokument beschriebene Produkt darf nur für den von uns beschriebenen Anwendungszweck eingesetzt werden. Die in den technischen Daten angegebenen maximalen Anschlusswerte und zulässigen Umgebungsbedingungen müssen dabei eingehalten werden. Für den einwandfreien und sicheren Betrieb des Gerätes wird sachgemässer Transport und Lagerung sowie fachgerechte Lagerung, Montage, Installation, Bedienung und Wartung vorausgesetzt.

1.4 Haftungsausschluss

Der Inhalt dieses Dokuments wurde auf Korrektheit geprüft. Es kann trotzdem Fehler oder Abweichungen enthalten, so dass wir für die Vollständigkeit und Korrektheit keine Gewähr übernehmen. Dies gilt insbesondere auch für verschiedene Sprachversionen dieses Dokuments. Dieses Dokument wird laufend überprüft und ergänzt. Erforderliche Korrekturen werden in nachfolgende Versionen übernommen und sind via unsere Webpage www.camillebauer.com verfügbar.

1.5 Rückmeldung

Falls Sie Fehler in diesem Dokument feststellen oder erforderliche Informationen nicht vorhanden sind, melden Sie dies bitte via E-Mail an: customer-support@camillebauer.com

1.6 Reparaturen und Änderungen

Reparatur und Änderungen dürfen ausschließlich vom Hersteller durchgeführt werden. Öffnen Sie das Gehäuse des Gerätes nicht. Falls irgendwelche unbefugten Änderungen am Gerät vorgenommen werden, erlischt der Garantieanspruch. Für Geräte, die nicht im Werk geöffnet wurden, kann keine Gewährleistung oder Garantie übernommen werden. Wir behalten uns das Recht vor, das Produkt für Verbesserungen zu verändern.

1.7 Kalibration und Neuabgleich

Jedes Gerät wird vor der Auslieferung abgeglichen und geprüft. Der Auslieferungszustand wird erfasst und in elektronischer Form abgelegt. Die Messunsicherheit von Messgeräten kann sich während des Betriebs ändern, falls z.B. die spezifizierten Umgebungsbedingungen nicht eingehalten werden.

1.8 Entsorgung



Geräte dürfen nur fachgerecht entsorgt werden!

Die Entsorgung der Geräte und Bestandteile darf nur unter Einhaltung guter professioneller Praktiken und nationaler Vorschriften entsorgt werden. Eine falsche Entsorgung kann die Umwelt gefährden.

1.9 Rücksendung

Alle an Camille Bauer Metrawatt AG gesandten Geräte müssen frei von allen gefährlichen Verunreinigungen sein (Säuren, Laugen, Lösungsmitteln, usw.). Benutzen Sie die Originalverpackung oder eine geeignete Transportverpackung zur Rücksendung des Geräts.



Beschädigung bei der Rücksendung

Für Schäden, die durch eine unsachgemäße Rücksendung hervorgerufen werden, wird keine Gewährleistung oder Garantie übernommen.

2. Einleitung

2.1 Bestimmung des Dokuments

Dieses Dokument beschreibt die Dreiphasen-Netzmessgerät SIRAX MT7100 und MT7150. Es richtet sich an Installateure, Inbetriebsetzer, Service- und Wartungspersonal.

Gültigkeitsbereich

Diese Betriebsanleitung ist für alle Varianten der Dreiphasen-Netzmessgerät SIRAX MT7100 und MT7150 gültig.

Vorkenntnisse

Allgemeine Kenntnisse der Elektrotechnik sind erforderlich. Für Montage und Anschluss wird die Kenntnis der landesüblichen Sicherheitsbestimmungen und Installationsnormen vorausgesetzt.

2.2 Lieferumfang

- Dreiphasen-Netzmessgerät SIRAX MT7100 oder MT7150 mit Montage-Set
- Sicherheitshinweise (de, en, fr, it, es, nl, cz)

2.3 Weitere Unterlagen

Folgende weitere Dokumente zum Gerät sind elektronisch via www.camillebauer.com verfügbar:

- Datenblatt (de, en)
- Sicherheitshinweise (de, en, fr, it, es, nl, cz) und Betriebsanleitung (de, en)
- Betriebsanleitung (de, en)

3. Funktionsbeschreibung

Der SIRAX MT7100 und MT7150 sind "All in One" Dreiphasen-Netzmessgeräte mit integriertem Energiezähler und universellen Stromeingang. Sie sind für den Hutschieneneinbau konzipiert und lassen sich an gängige Strom- und Spannungswandler und Rogowski Spulen anschliessen. Die Geräte messen RMS AC und DC, durchschnittliche min. und max. Werte, Frequenz, Crest Faktor, harmonische bis zur 63., THD, I_{peak} und U_{peak} und viele mehr. Sie sind mit einem seriellen Ausgang RS485 Modbus RTU für Messwerte und einem digitalen Ausgang für Alarme ausgestattet. Über die kostenlose Konfigurationssoftware lassen sich die Geräte sehr einfach konfigurieren.

4. Montage und Installation



Sorgen Sie während der Montage, Installations- und Wartungsarbeiten für eine sichere Arbeitsumgebung. Unterbrechen Sie die Stromzufuhr des Primärleiters und sichern Sie diese gegen unbeabsichtigtes Wiedereinschalten.

- Die Montage erfolgt über DIN-Hutschienenmontage und die Einbaulage der Geräte ist beliebig.
- Schliessen Sie nun das Gerät gemäss Anschlussschema an.

5. Elektrische Anschlüsse



Achtung: Lebensgefahr! Sicherstellen, dass beim Anschluss alle Leitungen spannungsfrei sind !



Es ist zu beachten, dass die auf dem Typenschild angegebenen Daten eingehalten werden!
Es sind die landesüblichen Vorschriften bei der Installation und Auswahl des Materials der elektrischen Leitungen zu befolgen!

3-Phasen, 4 Draht, 3 Stromwandler

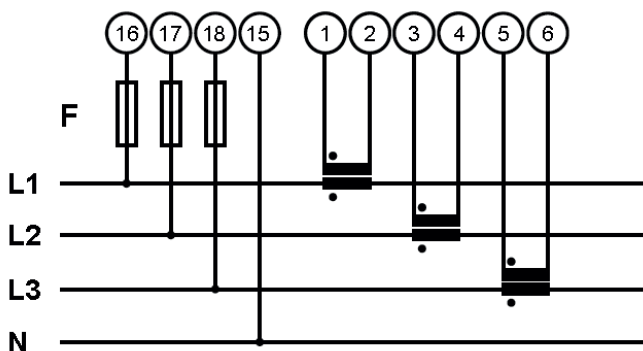

3-Phasen, 4 Draht, 3 Spannungswandler

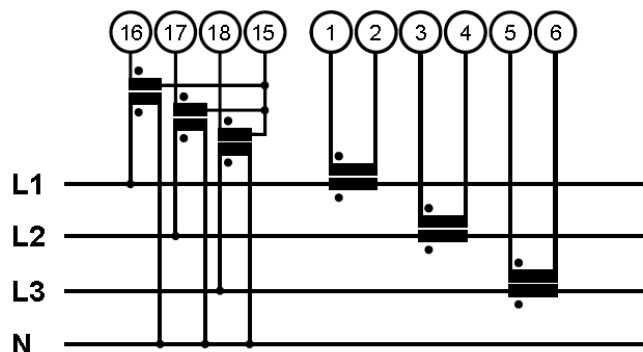

3-Phasen, 3 Draht, 3 Stromwandler

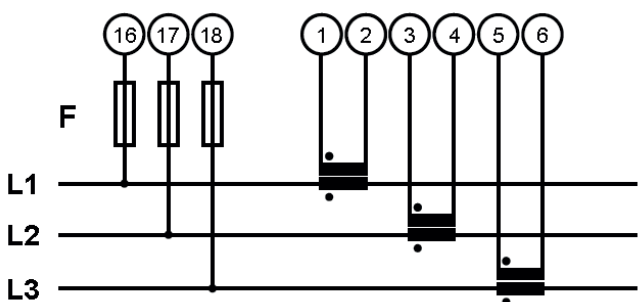

3-Phasen, 3 Draht, 3 Spannungswandler

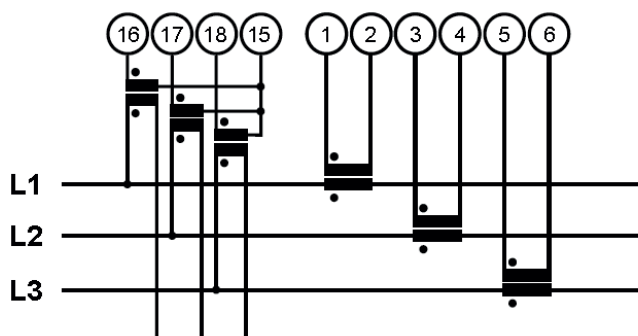

3-Phasen, 3 Draht, 2 Stromwandler (Aron)

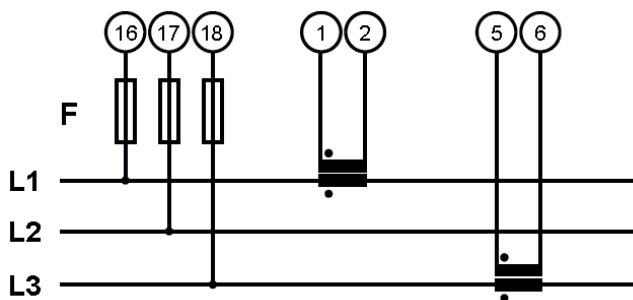

3-Phasen, 3 Draht, 2 Stromwandler/3 Spannungswandler (Aron)

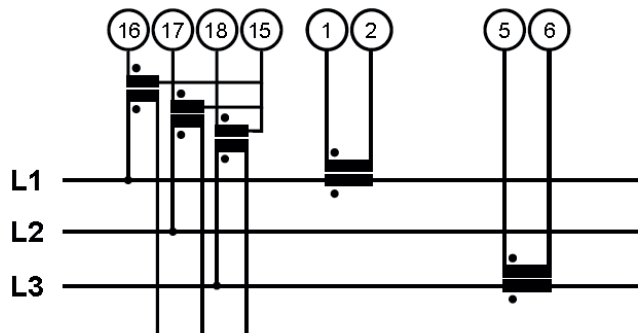

1-Phasen, 2 Draht, Verbindung mit 1 TA

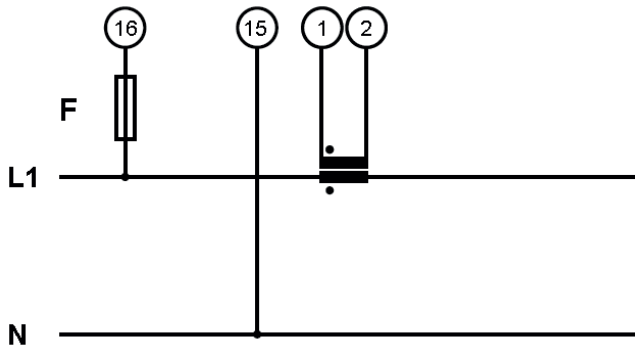

Digitaler Ausgang an Klemme 8-9-10 in digitaler Ausgangskonfiguration

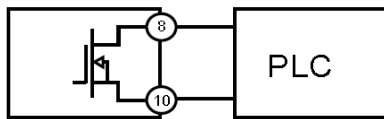

Kommunikation über T-BUS (mit dem entsprechenden optionalen Verbinder)

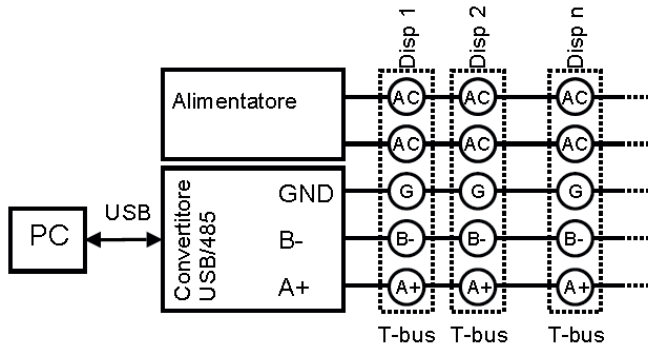

1-Phasen, 2 Draht, Verbindung mit 1 TA und 1TV

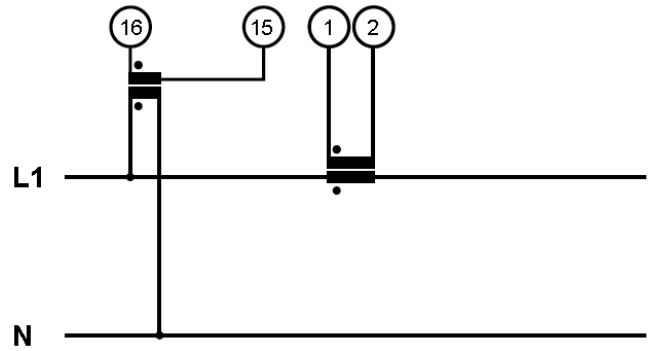

Stromversorgung

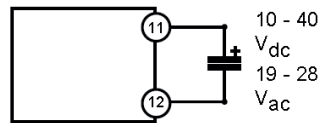

Kommunikation über Klemmen 8-9-10 in RS485-Konfiguration

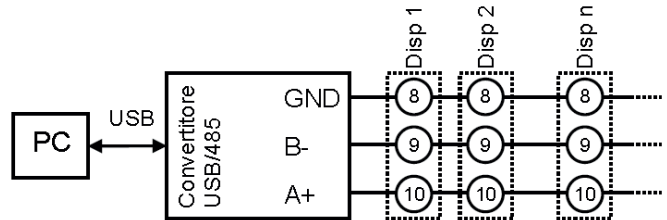

6. Technische Daten

	SIRAX MT7100	SIRAX MT7150
Eingang		
Stromsensoren	Rogowski Spulen; Stromwandler sekundär 1A/5A; Spannungswandler 0 ... 333 mV	
Verfügbare Messgrößen	I_{rms} ; U_{rms} ; I_{pk} ; U_{pk} pro Phase; Wirkleistung: P, P_1, P_2, P_3 ; Blindleistung: Q, Q_1, Q_2, Q_3 ; Scheinleistung: S, S_1, S_2, S_3 ; Frequenz; Leistungsfaktor Total und pro Phase; Energie (kWh) Total und pro Phase; bidirektionale Energie (kWh) Total und positiv/negativ pro Phase; Wirk- und Blindenergie (kVARh) Total und pro Phase; $\cos\varphi$; Crest Faktor Total und pro Phase $\tan\varphi$ pro Phase und Mittelwert; Leistungsfaktor Total, pro Phase und Mittelwert; Verzerrter Leistungsfaktor pro Phase und Mittelwert; Leistungsmessung min/max Total, pro Phase und Mittelwert; Überwachung der Phasenfolge; max Bedarf über 15 min. Total und pro Phase; Zeit bei der der max Bedarf entsteht (pro Monat) Total und pro Phase; Zeit über einer Schwelle Total und pro Phase; K Faktor; THD; TDD; harmonische Analyse bis zur 63.; interharmonische Analyse bis zur 63.; SAG; SWELL; Spannungsunterbrechung;	
Spannungseingang		
Nennspannung U_n	300 V_{LN} / 500 V_{LL}	
Impedanz	400 k Ω	

Kontinuierliche Überlast U_{max}	400 V _{LN} / 700 V _{LL}
Überlast für 500 ms	600 V _{LN} / 1000 V _{LL}
Stromeingang	
Typ	nicht isoliert (externe CTs notwendig)
Stromausgang CT's	
Nennstrom I_n	5 AAC
Impedanz	< 0.5 VA pro Phase
Kontinuierliche Überlast I_{max}	6 AAC
Überlast für 500 ms	40 AAC
Crest Faktor	< 4 (20 A _{PK} max.)
Spannungsausgang CT's	
Nennspannung	333 mVAC
Impedanz	220 kΩ
Kontinuierliche Überlast U_{max}	2.1 V _{PK}
Überlast für 500 ms	13 V _{PK}
Crest Faktor	< 3 (1 V _{PK} max.)
Arbeitsfrequenz	1 ... 70 Hz
Hilfsenergie	10 ... 30 VDC oder 19 ... 28 VAC
Verbrauch	< 0.7 W
Ausgang	
Digitalausgang	RS485 (Modbus RTU)
Baudrate	von 1200 ... 115200 (Grundeinstellung 9600)
Genauigkeit (@ 25 ±5 °C, Frequenz = 50 Hz)	
Spannung (U_n : 230/400V)	± 0.5% RDG (10 ... 100% U_n)
Strom (I_n : 5A)	± 0.5% RDG (5 ... 100% I_n)
Frequenz	± 0.1 Hz (40 ... 70 Hz)
Wirk- und Blindleistung	± 0.5% RDG
Wirkenergie	Klasse C nach EN50470-1/3 oder Klasse 0.5S nach EN62053-22
Blindenergie	Klasse 0.5S nach EN62053-24
Leistungsfaktor	± (0.001 +1%(1.00-PF))
Bandbreite (-3dB)	> 2 kHz
Temperaturkoeffizient	< 100 ppm/°C
Dämpfung	< 500 mW @ 24 VDC
Abtastrate	6400 Hz @ 50 Hz oder 7280 Hz @ 60 Hz
Energie-Backup	Via Flash, minimum Lebensdauer: 3 Jahre
Umgebungsbedingungen	
Umgebungstemperatur	-10 ... +60 °C
Lagertemperatur	-40 ... +85 °C
Relative Feuchte	10 ... 90 % (ohne Betauung)
Einsatzhöhe	max. 2000 m
Sicherheit	
Überspannungskategorie	CATIII
Isolation	4 kV _{RMS} zwischen Netzteil und Messeingängen 4 kV _{RMS} zwischen RS485 und Messeingängen 1.5 kV _{RMS} zwischen Netzteil und RS485

Gehäuseschutzart IP	IP20
Mechanische Eigenschaften	
Gehäusematerial	PTB
Brennbarkeitsklasse	UL94 V-0, selbstverlöschend, nicht tropfend, halogenfrei
Gewicht	60 g
DIP Switch	2 Pol
Dimensionen	93 x 17.7 x 68.3 mm (ohne Klemmen)
Anschlüsse	
Anschlüsse	Steckklemmen 3.5 mm, 1 x 2 Pol, 1 x 3 Pol, 1 x 6 Pol Steckklemmen 5.08 mm, 1 x 4 Pol
Anschlussquerschnitt	1.5 mm ²
Anzugsdrehmoment	max. 0.25 Nm
Normen	
Eingehaltene Normen	EN61000-6-2 ; EN61000-6-4; EN61000-4-2; EN61000-4-3; EN61000-4-4; EN61000-4-5; EN61000-4-6; EN61010-1; EN61010-2-30

Bezeichnung LED

Funktion	Zustand	Bemerkung	
Power (Grün)	Leuchtend	Gerät läuft	
Fehler (Gelb)	Blinkend	Bootloader aktiv: Kann über Modbus-Befehl oder wegen Flash-Korruption des Programms ausgelöst werden	
	Leuchtend	Mindestens einer der folgenden Zustände ist vorhanden:	
		EEPROM Fehler	Fehler beim Speichern des Flash für Einstellungen, Kalibrierung oder Energien
		Phasen vertauscht	Phasenfolge L ₁ , L ₂ , L ₃ ist nicht korrekt
		I _l oder U _l Überbereich	Strom- oder Spannungsphase hat einen zu hohen positiven Pegel
I _l oder U _l Unterbereich	Strom- oder Spannungsphase hat einen zu hohen negativen Pegel		
RX (Rot)	Blinkend	Das Gerät empfängt Daten von RS485	
TX (Rot)	Blinkend	Das Gerät sendet Daten von RS485	
D _{out} (Grün)	Leuchtend	Der digitale Ausgang ist geschlossen	

Digitalausgang Alarme

Steigen: Normal offener Kontakt

Fallen: Normal geschlossener Kontakt

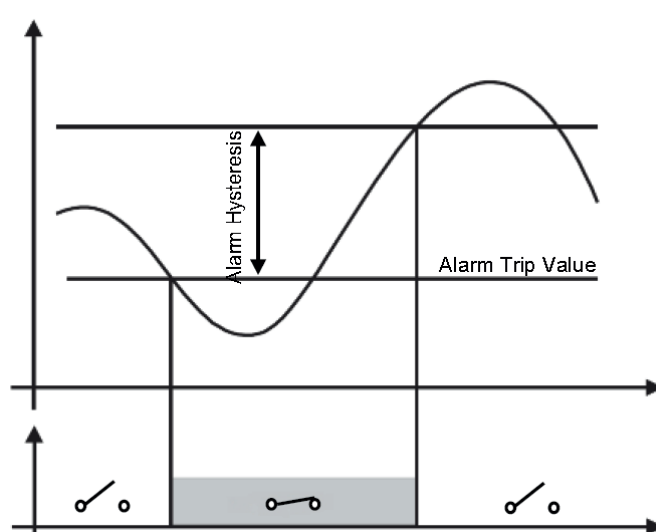
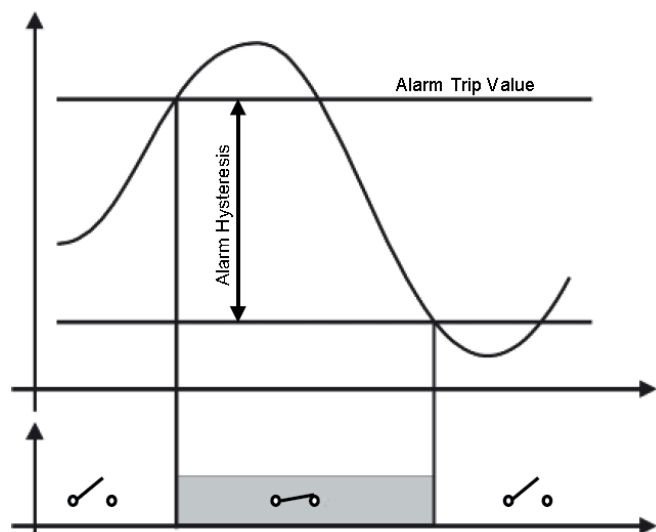

Fenster: geschlossener Kontakt zwischen den Schwellen

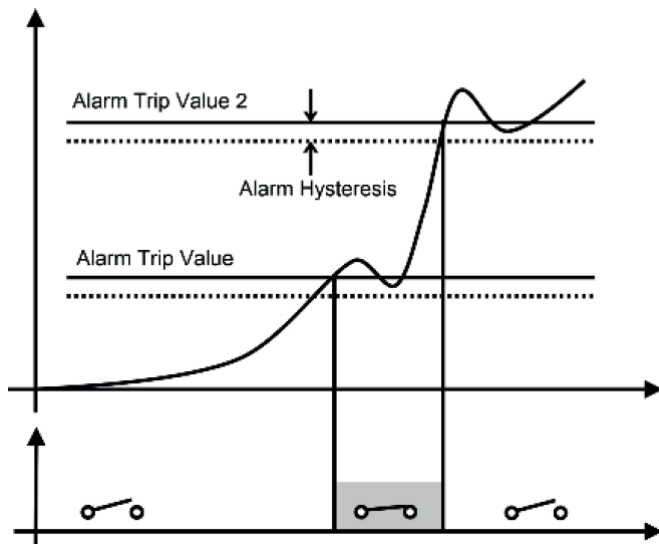

Fenster: geschlossener Kontakt ausserhalb der Schwellen

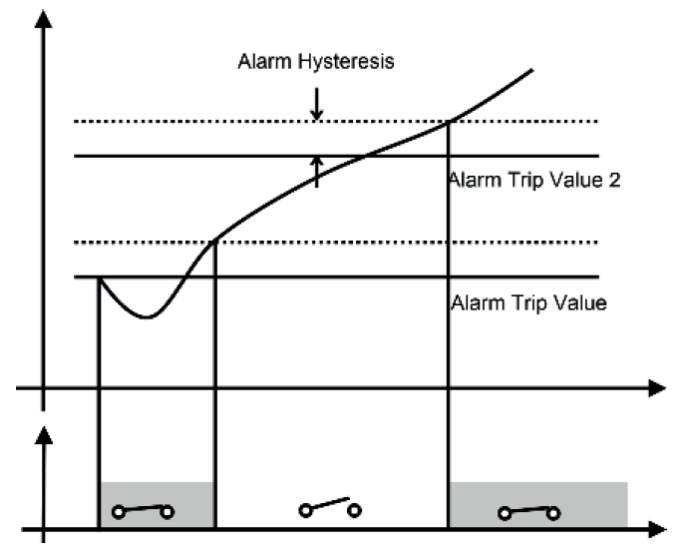

Hinweis: Um digitale Ausgangsalarme zu aktivieren, müssen die RS485-Anschlüsse für den digitalen Ausgang konfiguriert werden. Die Kommunikation wird nur am T-BUS verfügbar sein.

Genauigkeit (nach EN50470-3 und EN62053-24)

Wh, Genauigkeit abhängig von der Belastung (Stromausgang CT)

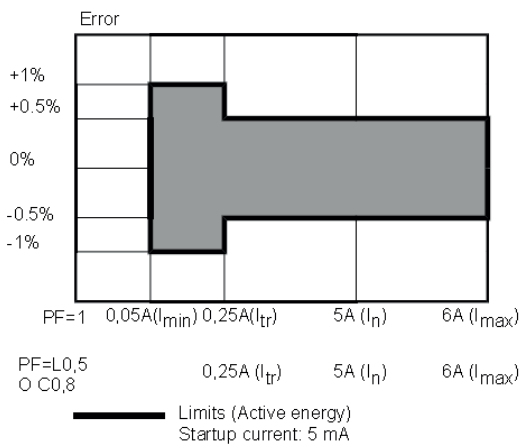

VARh, Genauigkeit abhängig von der Last (Stromausgang CT)

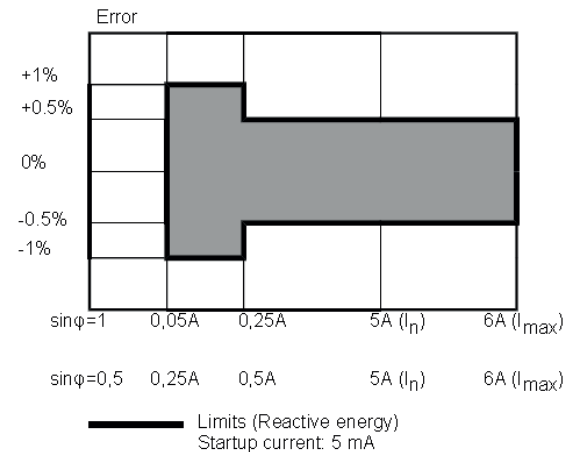

Wh, Genauigkeit abhängig von der Last (Spannungsausgang CT)

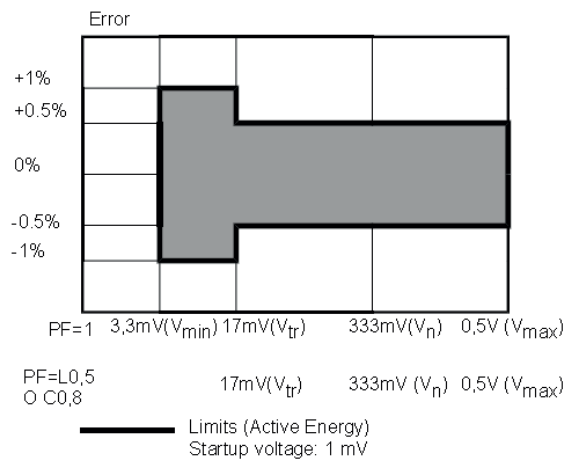

VARh, Genauigkeit abhängig von der Last (Spannungsausgang CT)

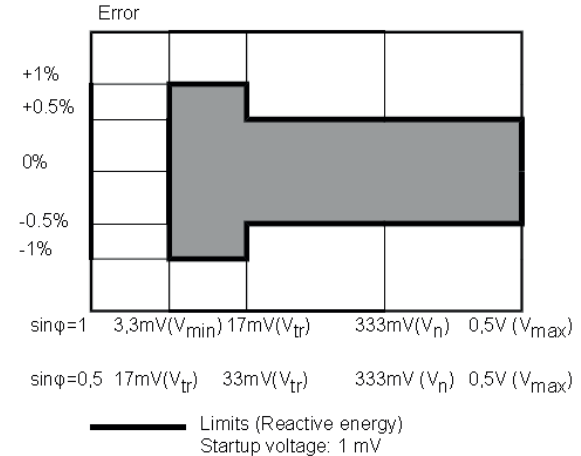

Hinweis: Die Genauigkeit der Blindleistung wird gewährt, wenn die Q-Berechnung des Geräts der Budeanu-Formel entspricht.

Benutzte Berechnungsformeln

Phasenvariablen

Spannung RMS

$$V_i = \sqrt{\frac{1}{N} * \sum_1^N (v_{Li})^2}$$

Strom RMS

$$I_i = \sqrt{\frac{1}{N} * \sum_1^N (i_{Li})^2}$$

Wirkleistung

$$P_i = \frac{1}{N} * \sum_1^N v_{Li} * i_{Li}$$

Scheinleistung

$$S_i = V_i * I_i$$

Blindleistung

$$Q_i = \frac{1}{N} * \sum_1^N v_{Li} \hat{i}_{Li} \quad \text{Budeanu}$$

$$Q_i = \sqrt{S_i^2 - P_i^2} \quad \text{triangular}$$

Leistungsfaktor

$$\cos \phi_i = \frac{P_i}{S_i}$$

Systemvariablen

Mittelwert Spannung

$$V_{AVG} = \frac{V_1 + V_2 + V_3}{3}$$

Mittelwert Strom

$$I_{AVG} = \frac{I_1 + I_2 + I_3}{3}$$

Dreiphasen-Wirkleistung

$$P_{3PH} = P_1 + P_2 + P_3$$

Dreiphasen-Scheinleistung

$$S_{3PH} = S_1 + S_2 + S_3$$

Dreiphasen-Blindleistung

$$Q_{3PH} = Q_1 + Q_2 + Q_3$$

Dreiphasen-Leistungsfaktor

$$\cos \phi_{3PH} = \frac{P_{3PH}}{S_{3PH}}$$

Energiemessung

Wirkenergie

$$Wh_i = \int_{t_1}^{t_2} P_i(t) dt \approx \Delta t \sum_{n_1}^{n_2} P(n_i)$$

Scheinenergie

$$VARh_i = \int_{t_1}^{t_2} Q_i(t) dt \approx \Delta t \sum_{n_1}^{n_2} Q(n_i)$$

Blindenergie

$$VAh_i = \int_{t_1}^{t_2} S_i(t) dt \approx \Delta t \sum_{n_1}^{n_2} S(n_i)$$

Woher:

i = beobachtete Phase (L1; L2 oder L3);

P = Wirkleistung;

Q = Blindleistung;

t1, t2 = Beginn und Ende der Zeitpunkte der Verbrauchsaufzeichnung;

n = Zeiteinheit;

t = Zeiteinheitlänge;

n1, n2 = Beginn und Ende diskreter Zeitpunkte der Verbrauchsaufzeichnung

7. Programmierung

Der SIRAX MT7100 und MT7150 lassen sich auf zwei Arten programmieren. Zum Einen über die serielle RS485-USB Schnittstelle und der Programmiersoftware und zum Andern über der direkten Verwendung der Modbus Adress-Register.

Wenn Sie die Geräte über die Programmiersoftware einstellen möchten, stellen Sie die DIP-Schalter auf 0. Wenn Sie direkt über die RS485 Modbus Schnittstelle einstellen wollen, stellen Sie den ersten DIP-Schalter auf 1 (oben) und dann den zweiten für die Baudrateneinstellung ein 0 für 9600 oder 1 für 38400. Nach den Einstellungen speichern Sie bitte die Konfiguration über das Befehls-Register, schalten Sie dann die Stromversorgung aus, bevor Sie zum Einschalten der Stromversorgung die DIP-Schalter auf 0 setzen.



Jegliche Änderungen durch den DIP-Schalter machen das Abschalten der Stromversorgung erforderlich. Es ist eine Sicherheitsbedingung, um jegliche Störung auf dem Gerät zu verhindern.

Beschreibung	1	2
RS485 Einstellungen vom EEPROM	0	X
Adresse 1 - Baudrate 9600, no parity	1	0
Adresse 1 - Baudrate 38400, no parity	1	1

7.1 Programmierung über Software

Laden Sie sich die Programmiersoftware kostenlos von unserer Homepage www.camillebauer.com herunter. Bevor Sie die Software verwenden können, kontrollieren Sie, ob Sie Java (32-Bit) auf Ihrem Rechner installiert haben. Wenn nicht, dann laden Sie die Java Software von der Homepage www.java.com herunter.

Um die Menüsprache der Software ändern zu können, gehen Sie in das heruntergeladene Verzeichnis der Software. Öffnen Sie das File "023.ini" mit einem Text Editor Programm. Ändern Sie nun die aufgeführte Sprache z.B. "EN" in die gewünschte Sprache z.B. "DE". Bitte beachten Sie, dass nur die im Verzeichnis aufgeführten Sprachen geändert werden können.

7.1.1 Konfiguration

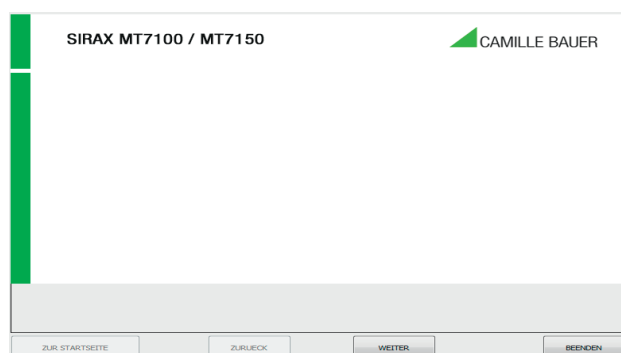

Starten Sie die Software mit der Datei SIRAX MT71xx_023_v003.jar

Klicken Sie nun auf "WEITER" um in das Menüfenster Verbindung zu gelangen.

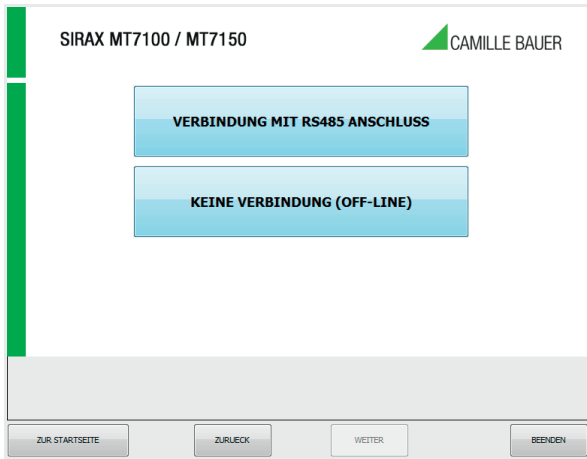

In diesem Modus können Sie wählen, ob Sie das Gerät über eine direkte Verbindung via RS485-USB, oder im Offline-Modus programmieren möchten.

Wählen Sie den Modus "Verbindung mit RS485 Anschluss", dann gelangen Sie zum Menü "Einstellung DIP-Schalter"

Wählen Sie den Modus "Keine Verbindung (OFF-Line), dann gelangen Sie DIREKT zum Menü "Konfiguration".

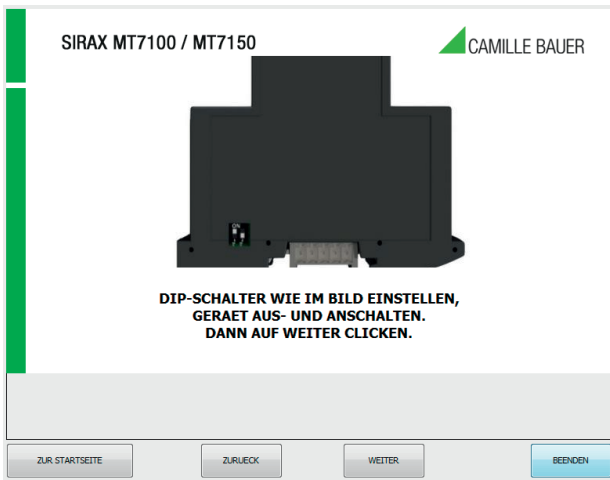

Stellen Sie die DIP-Schalter gemäss Vorlage ein. Genaue Angaben der einzelnen Positionen der DIP-Schalter entnehmen Sie aus der Tabelle "DIP-Schalter Einstellungen" auf Seite 10.

Drücken Sie auf "Weiter".

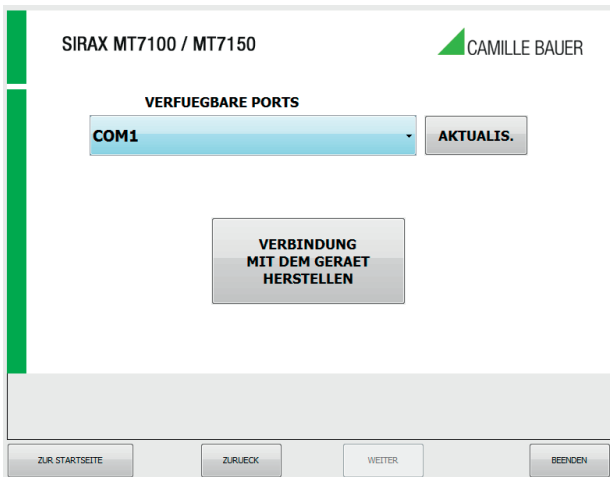

Um mit dem SIRAX MT7100 oder MT7150 zu kommunizieren, überprüfen Sie den verfügbaren COM PORT, indem Sie auf die Schaltfläche "AKTUALISIEREN" klicken. Ihr PC wird eine virtuelle COM für die Kommunikation mit dem SIRAX MT7100 oder MT7150 zuweisen.

Klicken Sie auf den Button "VERBINDUNG MIT DEM GERÄT HERSTELLEN". Sie sehen ein Fenster, in dem Sie gefragt werden, ob Sie mit dem Gerät verbunden sind. Klicken Sie dann auf diesen Button in diesem Fenster "WEITER". Nachdem Sie die Verbindung hergestellt haben, können Sie mit der Konfiguration des Geräts fortfahren.

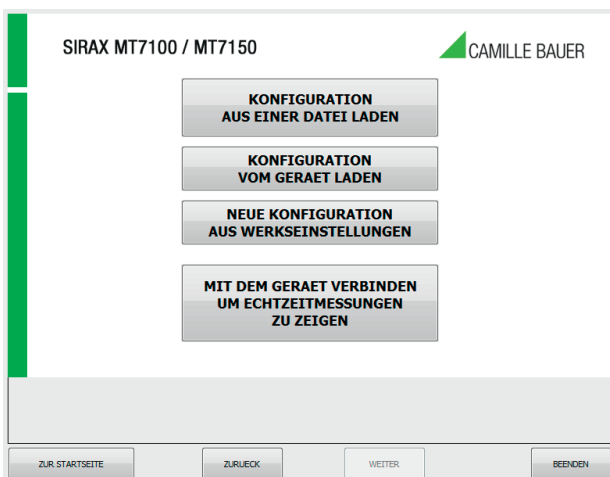

Wählen Sie nun die Art der Konfigurationserstellung aus.

Dies ist die Gerätekonfigurationsseite, auf der die Parameter für die Modbus Kommunikation eingestellt werden:

1. Die Modbus "ADRESSE", die dem Gerät zugewiesen werden soll
2. Der "Verzug" auf Antwort;
3. Die Geschwindigkeitskommunikation "BAUDRATE" (von 1200 bis 115200)
4. Die Parität ist immer Keine

Um die Standardeinstellungen zu verwenden, klicken Sie auf die Schaltfläche "WERKSEINSTELLUNGEN"

Dies ist die Gerätekonfigurationsseite, auf der die allgemeinen Eingangseinstellungen eingestellt werden. Es lassen sich folgende Parameter einstellen:

- Stromengang
- Anschlussparameter
- Berechnungsmethode der Blindleistung
- Quelle der Frequenzmessung
- Faktor Energieeinheit
- Energiespeicher ein/aus
- Messwerttyp
- Integrationszustand
- Messungsfilter

Dies ist die Gerätekonfigurationsseite, auf der die Leistungseinstellungen vorgenommen werden. Es lassen sich folgende Parameter einstellen:

- Wandlerverhältnisse
- Min. Welligkeit Spannung, Strom und Leistung
- AC oder DC Filter

Dies ist die Gerätekonfigurationsseite, auf der die Alarmeinstellungen eingestellt werden. Es gibt zwei Arten von wählbaren Alarmen, die Eine mit LED und die Andere mit Kontakt (Switch).

LED ALARM

Überprüfen Sie das Vorhandensein von Anomalien, der Benutzer kann Fehler-LED aktivieren, indem eine oder mehrere der vorhandenen Flags wählt.

SWITCH ALARM

Wenn Sie den gewünschten Parameter im Dropdown-Menü auswählen, stellen Sie den Schwellenwert und den Hysteresewert ein, um den Alarm am digitalen Ausgang zu aktivieren.

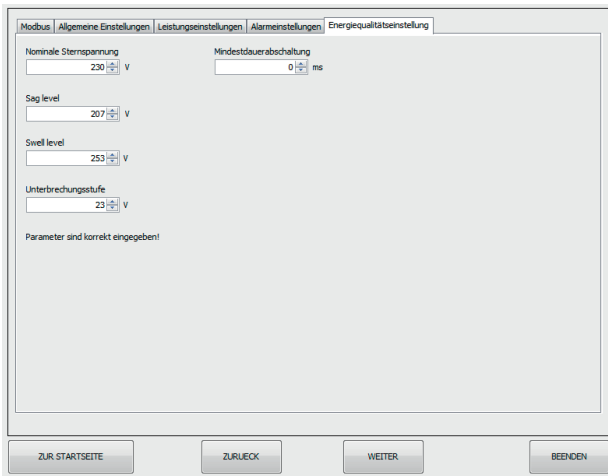

Dies ist die Gerätekonfigurationsseite, auf der die Energiequalitätseinstellungen vorgenommen werden. Es lassen sich folgende Parameter einstellen:

- Nominale Sternspannung
- SAG und SWELL Level
- Unterbrechungsstufe
- Mindestdauerabschaltung



Wählen sie nun ob Sie die Konfiguration in einem File speichern, oder diese an das Gerät übermitteln möchten.

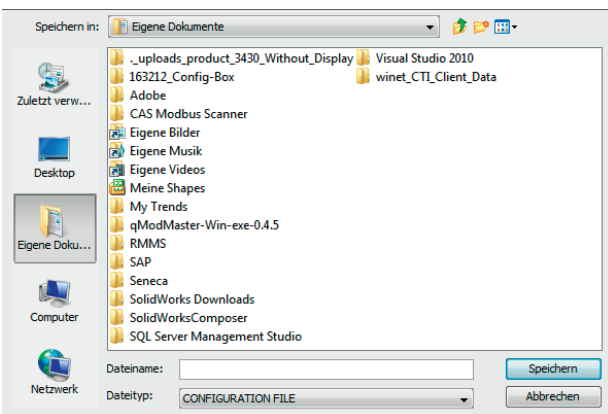

In diesem Bildschirm können Sie die Konfiguration in einer Datei speichern.

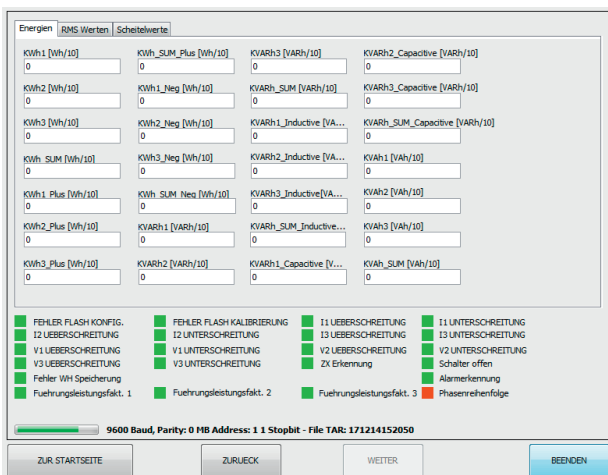

Mit dieser Anzeige können Sie die Funktionalität des Geräte überprüfen. Es lassen sich die Energiewerte, RMS Werte und Scheitelwerte anzeigen.

7.2 Programmierung über Modbus Adress-Register

Modbus Adresse	Register Name	Parameter Beschreibung	Register-Typ	Lesen / Schreiben	Standard Werte
40001	Maschinen_ID	Maschinen ID	Unsigned short	R	23 oder 32
40002	HW/FW_Version	Hardware (MSB) und Firmware (LSB) Version	Unsigned short	R	
40003	Adresse	Modbus Adresse	Unsigned short	R/W	1
40004	Verzögerung	Antwortverzögerung	Unsigned short	R/W	1
40005	Baudrate	Baudrate: 0=1200 / 1=2400 / 2=4800 / 3=9600 / 4=19200 / 5=38400 / 6=57600 / 7=115200	Unsigned short	R/W	3
40006	Parität	0=NONE / 1=ODD / 2=EVEN	Unsigned short	R/W	0
40007	Flag Messung	<p>Bit 0: Aktueller Messtyp 0=Eingang 1A/5A 1=Eingang 333mV / Rogowski</p> <p>Bit 1...2: Verbindung 0=Einphasig 1=Dreiphasen: 3-Draht, 2 Stromwandler (Aron) 2=Dreiphasen: 3-Draht, 3 Stromwandler 3=Dreiphasen: 4-Draht, 3 Stromwandler (mit Neutral)</p> <p>Bit 3: FFT-Darstellung 0=Absolut 1=Relativ zum I1-Wert</p> <p>Bit 5: Berechnung der Blindleistung 0=Dreiecks-Methode 1=Budeanu-Methode</p> <p>Bit 6: RS485 oder Schalter 0=RS485 1=Schalter</p> <p>Bit 7: Frequenzerkennungskanal 0=Spannung 1=Strom</p> <p>Bit 8: Spannungseingangstyp 0=Normale Belastung 1=PWM modulierter Eingang (Wechselrichterlast)</p> <p>Bit 9: Energiesparen 0=Deaktiviert 1=Aktiviert</p> <p>Bit 11...12: Messformat 0=Float 1=Float gedreht 2=Hundertstel (Float *100) 3=Hundertstel gedreht (Float *100 SW)</p> <p>Bit 13: Integratorzustand 0=Integrator deaktiviert 1=Integrator aktiviert (Rogowski Eingang)</p> <p>Bit 10, 14: Ausgangszustand Ausgangsschalters 0=Geschlossene Ausgangsbedingung 1=Fenster: geschlossener Kontakt zwischen Schwellen 2=Offene Ausgangsbedingung 3=Fenster: geschlossener Kontakt ausserhalb Schwellen</p> <p>Bit 15: Filterung der Messwerte 0=Filter deaktiviert 1=Filter aktiviert</p>	Unsigned short	R/W	16934 INPUT_1A_5A I THREE_PHASE_4W_3CT I FFT_REPRESENTATION_ABSOLUTE I BUDEANU I RS485_BEHAVIOUR I FREQUENCY_DETECT_ON_ON_VOLTAGE I NORMAL_INPUT_ENERGY_SAVING_ENABLED I FLOAT_TYPE_INTEGRATOR_DISABLED I OPEN_COND I FILTERED_OUTPUT_DISABLED
40008	LED Einstellungen	Stellen Sie die Fehler LED entsprechend dem Bit ein: 0=Fehler EEPROM (Einstellungen, Kalibrierung oder Energie) 1=Phasenumkehr 2=I1 Überschreitung 3=I1 Unterschreitung 4=I2 Überschreitung 5=I2 Unterschreitung 6=I3 Überschreitung 7=I3 Unterschreitung 8=U1 Überschreitung 9=U1 Unterschreitung 10=U2 Überschreitung 11=U2 Unterschreitung 12=U3 Überschreitung 13=U3 Unterschreitung	Unsigned short	R/W	1: Fehler EEPROM

40009	Wandlerverhältnis	Wenn Eingang 1A / 5A → Stromwandlerverhältnis M/N (Beispiel: TA-Verhältnis = 600: 5 → Wandlerverhältnis = 120) Wenn Eingang Rogowski / 333mV → 1 / Empfindlichkeit [V / A] (Bsp.: Empfindlichkeit = 100mV / 1KA → Wandlerverhältnis = 10000; Empfindlichkeit = 333mV / 5A → Wandlerverhältnis = 15)	Float	R/W	1
40011	Stromwandlerverzögerung	Stromwandlerverzögerung in [°] @ 50 Hz für genaue Leistungsberechnung	Float	R/W	0
40013	Spannungswandlerbereich	Spannungswandlerbereich M/N - Standard 1.0 (Bsp.: 1000:100 → Wandlerverhältnis = 10)	Float	R/W	1
40015	Spannungswandlerverzögerung	Spannungswandlerverzögerung in [°] @ 50 Hz für genaue Leistungsberechnung	Float	R/W	0
40017	Minimale Spannungswelligkeit	Mindestschwelle, bei der das Gerät 0 liest unabhängig vom Eingangswert	Float	R/W	0
40019	Minimale Stromwelligkeit	Mindestschwelle, bei der das Gerät 0 liest unabhängig vom Eingangswert	Float	R/W	0
40021	Minimale Leistungswelligkeit	Mindestschwelle, bei der das Gerät 0 liest unabhängig vom Eingangswert (P, Q und S)	Float	R/W	0
40023	DC Filter	Anzahl der Zehntelsekunden für den I RMS-Wert in DC	Unsigned short	R/W	10
40024	AC Filter	Anzahl der Nulldurchgänge für den I RMS-Wert in AC	Unsigned short	R/W	50
40025	Minute_für_Max_Anforderung	Minute für maximale Bedarfsberechnung (0..45)	Unsigned short	R/W	15
40027	Sekunden_zum_Mittelwert_RMS	Registrierung in Sekunden (0..30) für den RMS-Durchschnitt	Unsigned short	R/W	0
40028	Sekunden_für_Max_RMS	Sekunden 1..30 für MAX RMS-Wert. Wenn das Register 0 ist, wird der absolute MAX RMS angegeben	Unsigned short	R/W	0
40029	Sekunden_für_Min_RMS	Sekunden 1..30 für minimalen RMS-Wert. Wenn das Register 0 ist, wird der absolute min RMS angegeben	Unsigned short	R/W	0
40030	Faktor der Energieeinheit	Variable zum Ändern der Energiemesseinheit: 0=Wh/10 1=Wh 4=kWh	Unsigned short	R/W	0
40036	Alarm_Register_Start_Adresse	Float-Wert Startadresse für Alarm (40361 V_L1_N, 40363 V_L2_N, 40365 V_L3_N, ecc)	Unsigned short	R/W	40361
40037	Alarm_Trip_Wert	Alarmschwelle für "geschlossen" und "offen" oder erster Alarmschwelle für "innerhalb der Schwelle" und "außerhalb der Schwelle"	Float	R/W	0
40039	Alarm Hysterese	Alarm Hysterese	Float	R/W	1
40041	Alarm_Trip_Wert 2	Zweite Alarmschwelle für "innerhalb der Schwelle" und "außerhalb der Schwelle"	Float	R/W	
40043	Leistungsschwelle für Überschreitung	Schwelle für Überwachung der Leistungsüberschreitungen	Float	R/W	0
40045	Nominale Sternspannung	Nominale Sternspannung für Sag, Swell und Unterbrechungsüberwachung [V]	Float	R/W	230
40047	Sag Prozentsatz	Prozentsatz über der nominalen Sternspannung, unter dem ein Sag-Ereignis generiert wird (Standard 0,9 = 90%)	Float	R/W	0.9
40049	Swell Prozentsatz	Prozentsatz über der nominalen Sternspannung, über die ein Swell-Ereignis generiert wird (Standard 1,1 = 110%)	Float	R/W	1.1
40051	Prozentsatz der Unterbrechung	Prozentsatz über der nominalen Sternspannung, unter dem ein Unterbrechungseignis generiert wird (Standard 0,1 = 10%)	Float	R/W	0.1
40053	Mindestdauer-Abschaltung	Überschreitungs-, Überhöhungs- oder Unterbrechungseignisse müssen über dieser Grenze liegen, um angezeigt und gespeichert zu werden [ms]	Unsigned short	R/W	0

40239	Status_1	Bit 0: Fehler Flash-Einstellungen Bit 1: Fehler Flash-Kalibrierung Bit 2: Überspannung Strom I1 Bit 3: Unterspannung Strom I1 Bit 4: Überspannung Strom I2 Bit 5: Unterspannung Strom I2 Bit 6: Überspannung Strom I3 Bit 7: Unterspannung Strom I3 Bit 8: Überspannung Strom U1 Bit 9: Unterspannung Strom U1 Bit 10: Überspannung Strom U2 Bit 11: Unterspannung Strom U2 Bit 12: Überspannung Strom U3 Bit 13: Unterspannung Strom U3 Bit 14: Nulldurchgangserkennung Bit 15: Switch offen Bit 16: Wh Speicherfehler Bit 17..18: spielt keine Rolle Bit 19: Alarmerkennung Bit 20...27: spielt keine Rolle Bit 28: Führender Leistungsfaktor PF1 Bit 29: Führender Leistungsfaktor PF2 Bit 30: Führender Leistungsfaktor PF3	Unsigned long	R	
40244	Befehl	Flash-Einstellungen speichern Befehl = 0xC1C0; Reset-Befehl = 0xC1A0; Energie sparen Befehl = 0xBABA; Close Switch Befehl = 0xDAAA (nur wenn Digital Output aktiviert ist); Open Switch Befehl = 0xDAAB (nur wenn Digital Output aktiviert ist); Geben Sie den Bootloader-Befehl = 0xB000 ein; Setzen Sie den MAX Demand-Registerbefehl = 0xF000 zurück	Unsigned short	R/W	
40245	kWh 1	Aktive Energieleitung 1 [Wh Zentel]	Signed long long	R/W	
10249	kWh 2	Aktive Energieleitung 2 [Wh Zentel]	Signed long long	R/W	
40253	kWh 3	Aktive Energieleitung 3 [Wh Zentel]	Signed long long	R/W	
40257	kWh Summe	Aktive Energie dreiphasig [Wh Zentel]	Signed long long	R/W	
40261	kWh 1 positiv	Positive aktive Energieleitung 1 [Wh Zentel]	Signed long long	R/W	
40265	kWh 2 positiv	Positive aktive Energieleitung 2 [Wh Zentel]	Signed long long	R/W	
40269	kWh 3 positiv	Positive aktive Energieleitung 3 [Wh Zentel]	Signed long long	R/W	
40273	kWh Summe positiv	Positive aktive Energie dreiphasig [Wh Zentel]	Signed long long	R/W	
40277	kWh 1 negativ	Negative aktive Energieleitung 1 [Wh Zentel]	Signed long long	R/W	
40281	kWh 2 negativ	Negative aktive Energieleitung 2 [Wh Zentel]	Signed long long	R/W	
40285	kWh 3 negativ	Negative aktive Energieleitung 3 [Wh Zentel]	Signed long long	R/W	
40289	kWh Summe negativ	Negative aktive Energie dreiphasig [Wh Zentel]	Signed long long	R/W	
40293	kVARh 1	Blindenergie Leitung 1 [VARh Zentel]	Signed long long	R/W	
40297	kVARh 2	Blindenergie Leitung 2 [VARh Zentel]	Signed long long	R/W	
40301	kVARh 3	Blindenergie Leitung 3 [VARh Zentel]	Signed long long	R/W	
40305	kVARh Summe	Blindenergie dreiphasig [VARh Zentel]	Signed long long	R/W	
40309	kVARh 1 induktiv	Induktive Blindenergie Leitung 1 [VARh Zentel]	Signed long long	R/W	
40313	kVARh 2 induktiv	Induktive Blindenergie Leitung 2 [VARh Zentel]	Signed long long	R/W	
40317	kVARh 3 induktiv	Induktive Blindenergie Leitung 3 [VARh Zentel]	Signed long long	R/W	
40321	kVARh Summe induktiv	Induktive Blindenergie dreiphasig [VARh Zentel]	Signed long long	R/W	
40325	kVARh 1 kapazitiv	Kapazitive Blindenergie Leitung 1 [VARh Zentel]	Signed long long	R/W	
40329	kVARh 2 kapazitiv	Kapazitive Blindenergie Leitung 2 [VARh Zentel]	Signed long long	R/W	
40333	kVARh 3 kapazitiv	Kapazitive Blindenergie Leitung 3 [VARh Zentel]	Signed long long	R/W	
40337	kVARh Summe kapazitiv	Kapazitive Blindenergie dreiphasig [VARh Zentel]	Signed long long	R/W	
40341	kVAh 1	Scheinenergie Leitung 1 [VAh Zentel]	Signed long long	R/W	
40345	kVAh 2	Scheinenergie Leitung 2 [VAh Zentel]	Signed long long	R/W	
40349	kVAh 3	Scheinenergie Leitung 3 [VAh Zentel]	Signed long long	R/W	
40353	kVAh Summe	Scheinenergie dreiphasig [VAh Zentel]	Signed long long	R/W	
40357	Wh Speicheranzahl	Anzahl der Wh Flashspeicherung (alle 20 Sek.)	Unsigned long	R	
40359	U_L1_N	RMS Sternspannung L1_N [V]	Float	R	
40361	U_L2_N	RMS Sternspannung L2_N [V]	Float	R	
40363	U_L3_N	RMS Sternspannung L3_N [V]	Float	R	

40365	Durchschnitt_U_Stern	RMS Sternspannung Durchschnitt [V]	Float	R	
40367	U_L1_L2	RMS Leitungsspannung L1_L2 [V]	Float	R	
40369	U_L2_L3	RMS Leitungsspannung L2_L3 [V]	Float	R	
40371	U_L3_L1	RMS Leitungsspannung L3_L1 [V]	Float	R	
40373	Durchschnitt_U_Leitung	RMS Leitungsspannung Durchschnitt [V]	Float	R	
40375	I_L1	RMS Leitungsstrom L1 [A]	Float	R	
40377	I_L2	RMS Leitungsstrom L2 [A]	Float	R	
40379	I_L3	RMS Leitungsstrom L3 [A]	Float	R	
40381	I_N	RMS Leitungsstrom N [A] (wenn 1 oder 2 TA-Verbindung, I_N=0)	Float	R	
40383	I_Durchschnitt	RMS Leitungsstrom Durchschnitt [A]	Float	R	
40385	P1	RMS Wirkleistung L1 [W]	Float	R	
40387	P2	RMS Wirkleistung L2 [W]	Float	R	
40389	P3	RMS Wirkleistung L3 [W]	Float	R	
40391	P_Summe	RMS Wirkleistung Summe [W]	Float	R	
40393	Q1	RMS Blindleistung L1 [VAR]	Float	R	
40395	Q2	RMS Blindleistung L2 [VAR]	Float	R	
40397	Q3	RMS Blindleistung L3 [VAR]	Float	R	
40399	Q_Summe	RMS Blindleistung Summe [VAR]	Float	R	
40401	S1	RMS Scheinleistung L1 [VA]	Float	R	
40403	S2	RMS Scheinleistung L2 [VA]	Float	R	
40405	S3	RMS Scheinleistung L3 [VA]	Float	R	
40407	S_Summe	RMS Scheinleistung Summe [VA]	Float	R	
40409	PF1	Leistungsfaktor Leitung 1	Float	R	
40411	PF2	Leistungsfaktor Leitung 2	Float	R	
40413	PF3	Leistungsfaktor Leitung 3	Float	R	
40415	PF_3PH	Leistungsfaktor dreiphasig	Float	R	
40417	CF1	Crest Faktor Leitung 1	Float	R	
40419	CF2	Crest Faktor Leitung 2	Float	R	
40421	CF3	Crest Faktor Leitung 3	Float	R	
40423	CF_N	Crest Faktor Neutral	Float	R	
40425	Frequenz	Frequenz [Hz]	Float	R	
40427	U_L1_N_peak	Sternspannung L1_N peak [V]	Float	R/W	
40429	U_L2_N_peak	Sternspannung L2_N peak [V]	Float	R/W	
40431	U_L3_N_peak	Sternspannung L3_N peak [V]	Float	R/W	
40433	U_L1_L2_peak	Sternspannung L1_L2 peak [V]	Float	R/W	
40435	U_L2_L3_peak	Sternspannung L2_L3 peak [V]	Float	R/W	
40437	U_L3_L1_peak	Sternspannung L3_L1 peak [V]	Float	R/W	
40439	I_L1_peak	Strom L1 peak [A]	Float	R/W	
40441	I_L2_peak	Strom L2 peak [A]	Float	R/W	
40443	I_L3_peak	Strom L3 peak [A]	Float	R/W	
40445	I_N_peak	Strom N peak [A]	Float	R/W	
40467	DPF1	Verzerrungsleistungsfaktor L1 (+ induktiv, - kapazitiv)	Float	R	
40469	DPF2	Verzerrungsleistungsfaktor L2 (+ induktiv, - kapazitiv)	Float	R	
40471	DPF3	Verzerrungsleistungsfaktor L2 (+ induktiv, - kapazitiv)	Float	R	
40473	DPF_N	Verzerrungsleistungsfaktor N (+ induktiv, - kapazitiv)	Float	R	
40475	TAN_FL1	Tanφ L1 (+ induktiv, - kapazitiv)	Float	R	
40477	TAN_FL2	Tanφ L2 (+ induktiv, - kapazitiv)	Float	R	
40479	TAN_FL3	Tanφ L3 (+ induktiv, - kapazitiv)	Float	R	
40481	TAN_FL_Durchschnitt	Tanφ Durchschnitt (+ induktiv, - kapazitiv)	Float	R	
40483	Phase_Order	L1, L2, L3 = 0 / L1, L3, L2 = 1	Float	R	
40485	Interne Temperatur	Interne Temperatur [°C]	Float	R	
40487	U_L1_N_RMS_AVG	Sternspannung L1_N RMS Durchschnitt [V] über "Sekunden für den Mittelwert RMS"	Float	R	
40489	U_L1_N_RMS_Max	Sternspannung L1_N RMS Max.[V] über die letzten "Sekunden für den Max. RMS"	Float	R	
40491	U_L1_N_RMS_Min	Sternspannung L1_N RMS Min.[V] über die letzten "Sekunden für den Min. RMS"	Float	R	
40493	U_L2_N_RMS_AVG	Sternspannung L2_N RMS Durchschnitt [V] über "Sekunden für den Mittelwert RMS"	Float	R	
40495	U_L2_N_RMS_Max	Sternspannung L2_N RMS Max.[V] über die letzten "Sekunden für den Max. RMS"	Float	R	

40497	U_L2_N_RMS_Min	Sternspannung L2_N RMS Min.[V] über die letzten "Sekunden für den Min. RMS"	Float	R	
40499	U_L3_N_RMS_AVG	Sternspannung L3_N RMS Durchschnitt [V] über "Sekunden für den Mittelwert RMS"	Float	R	
40501	U_L3_N_RMS_Max	Sternspannung L3_N RMS Max.[V] über die letzten "Sekunden für den Max. RMS"	Float	R	
40503	U_L3_N_RMS_Min	Sternspannung L3_N RMS Min.[V] über die letzten "Sekunden für den Min. RMS"	Float	R	
40505	U_Stern_AVG_RMS_AVG	Sternspannung Durchschnitt RMS Durchschnitt [V] über "Sekunden für den Mittelwert RMS"	Float	R	
40507	U_Stern_AVG_RMS_Max.	Sternspannung Durchschnitt RMS Max. [V] über die letzten "Sekunden für den Max. RMS"	Float	R	
40509	U_Stern_AVG_RMS_Min.	Sternspannung Durchschnitt RMS Min. [V] über die letzten "Sekunden für den Min. RMS"	Float	R	
40511	U_L1_L2_RMS_AVG	Netzspannung L1 - Netzspannung L2 - Netzspannung L3 - L1 RMS-Mittelwert [V] über "Sekunden für Mittelwert RMS"	Float	R	
40513	U_L1_L2_RMS_Max.	Netzspannung L1 - Netzspannung L2 - Netzspannung L3 - L1 RMS-Max. [V] über die letzten "Sekunden für den Max. RMS"	Float	R	
40515	U_L1_L2_RMS_Min.	Netzspannung L1 - Netzspannung L2 - Netzspannung L3 - L1 RMS-Max. [V] über die letzten "Sekunden für den Min. RMS"	Float	R	
40517	U_L2_L3_RMS_AVG	Netzspannung L2 - Netzspannung L3 - L1 RMS-Mittelwert [V] über "Sekunden für Mittelwert RMS"	Float	R	
40519	U_L2_L3_RMS_Max.	Netzspannung L2 - Netzspannung L3 - L1 RMS-Max. [V] über die letzten "Sekunden für den Max. RMS"	Float	R	
40521	U_L2_L3_RMS_Min.	Netzspannung L2 - Netzspannung L3 - L1 RMS-Max. [V] über die letzten "Sekunden für den Min. RMS"	Float	R	
40523	U_L3_L1_RMS_AVG	Netzspannung L3 - L1 RMS-Mittelwert [V] über "Sekunden für Mittelwert RMS"	Float	R	
40525	U_L3_L1_RMS_Max.	Netzspannung L3 - L1 RMS-Max. [V] über die letzten "Sekunden für den Max. RMS"	Float	R	
40527	U_L3_L1_RMS_Min.	Netzspannung L3 - L1 RMS-Max. [V] über die letzten "Sekunden für den Min. RMS"	Float	R	
40529	U_Line_AVG_RMS_AVG	Leitungsspannung Durchschnitt RMS Durchschnitt [V] über "Sekunden für den Mittelwert RMS"	Float	R	
40531	U_Line_AVG_RMS_Max.	Leitungsspannung Durchschnitt RMS Max. [V] über die letzten "Sekunden für den Max. RMS"	Float	R	
40533	U_Line_AVG_RMS_Min.	Leitungsspannung Durchschnitt RMS Min. [V] über die letzten "Sekunden für den Min. RMS"	Float	R	
40535	I_L1_RMS_AVG	Strom L1 RMS Durchschnitt [A] über "Sekunden für den Mittelwert RMS"	Float	R	
40537	I_L1_RMS_Max.	Strom L1 RMS Max. [A] über die letzten "Sekunden für den Max. RMS"	Float	R	
40539	I_L1_AVG_Min.	Strom L1 RMS Min. [A] über die letzten "Sekunden für den Min. RMS"	Float	R	
40541	I_L2_RMS_AVG	Strom L2 RMS Durchschnitt [A] über "Sekunden für den Mittelwert RMS"	Float	R	
40543	I_L2_RMS_Max.	Strom L2 RMS Max. [A] über die letzten "Sekunden für den Max. RMS"	Float	R	
40545	I_L2_AVG_Min.	Strom L2 RMS Min. [A] über die letzten "Sekunden für den Min. RMS"	Float	R	
40547	I_L3_RMS_AVG	Strom L3 RMS Durchschnitt [A] über "Sekunden für den Mittelwert RMS"	Float	R	
40549	I_L3_RMS_Max.	Strom L3 RMS Max. [A] über die letzten "Sekunden für den Max. RMS"	Float	R	
40551	I_L3_AVG_Min.	Strom L3 RMS Min. [A] über die letzten "Sekunden für den Min. RMS"	Float	R	
40553	I_N_RMS_AVG	Strom N RMS Durchschnitt [A] über "Sekunden für den Mittelwert RMS"	Float	R	
40555	I_N_RMS_Max.	Strom N RMS Max. [A] über die letzten "Sekunden für den Max. RMS"	Float	R	
40557	I_N_AVG_Min.	Strom N RMS Min. [A] über die letzten "Sekunden für den Min. RMS"	Float	R	

40559	L_AVG_RMS_AVG	Strom Durchschnitt RMS [A] Durchschnitt über "Sekunden für den Mittelwert RMS"	Float	R	
40561	L_AVG_RMS_Max.	Strom Durchschnitt RMS [A] Max. über die letzten "Sekunden für den Max. RMS"	Float	R	
40563	L_AVG_RMS_Min.	Strom Durchschnitt RMS [A] Min. über die letzten "Sekunden für den Min. RMS"	Float	R	
40565	P1_RMS_AVG	Wirkleistung P1 RMS Durchschnitt [A] über "Sekunden für den Mittelwert RMS"	Float	R	
40567	P1_RMS_Max.	Wirkleistung P1 RMS Max. [A] über die letzten "Sekunden für den Max. RMS"	Float	R	
40569	P1_RMS_Min.	Wirkleistung P1 RMS Min. [A] über die letzten "Sekunden für den Min. RMS"	Float	R	
40571	P2_RMS_AVG	Wirkleistung P2 RMS Durchschnitt [A] über "Sekunden für den Mittelwert RMS"	Float	R	
40573	P2_RMS_Max.	Wirkleistung P2 RMS Max. [A] über die letzten "Sekunden für den Max. RMS"	Float	R	
40575	P2_RMS_Min.	Wirkleistung P2 RMS Min. [A] über die letzten "Sekunden für den Min. RMS"	Float	R	
40577	P3_RMS_AVG	Wirkleistung P3 RMS Durchschnitt [A] über "Sekunden für den Mittelwert RMS"	Float	R	
40579	P3_RMS_Max.	Wirkleistung P3 RMS Max. [A] über die letzten "Sekunden für den Max. RMS"	Float	R	
40581	P3_RMS_Min.	Wirkleistung P3 RMS Min. [A] über die letzten "Sekunden für den Min. RMS"	Float	R	
40583	P-SUM_RMS_AVG	Wirkleistung P Summe RMS Durchschnitt [A] über "Sekunden für den Mittelwert RMS"	Float	R	
40585	P_SUM_RMS_Max.	Wirkleistung P Summe RMS Max. [A] über die letzten "Sekunden für den Max. RMS"	Float	R	
40587	P_SUM_RMS_Min.	Wirkleistung P Summe RMS Min. [A] über die letzten "Sekunden für den Min. RMS"	Float	R	
40589	Q1_RMS_AVG	Blindleistung Q1 RMS Durchschnitt [A] über "Sekunden für den Mittelwert RMS"	Float	R	
40591	Q1_RMS_Max.	Blindleistung Q1 RMS Max. [A] über die letzten "Sekunden für den Max. RMS"	Float	R	
40593	Q1_RMS_Min.	Blindleistung Q1 RMS Min. [A] über die letzten "Sekunden für den Min. RMS"	Float	R	
40595	Q2_RMS_AVG	Blindleistung Q2 RMS Durchschnitt [A] über "Sekunden für den Mittelwert RMS"	Float	R	
40597	Q2_RMS_Max.	Blindleistung Q2 RMS Max. [A] über die letzten "Sekunden für den Max. RMS"	Float	R	
40599	Q2_RMS_Min.	Blindleistung Q2 RMS Min. [A] über die letzten "Sekunden für den Min. RMS"	Float	R	
40601	Q3_RMS_AVG	Blindleistung Q3 RMS Durchschnitt [A] über "Sekunden für den Mittelwert RMS"	Float	R	
40603	Q3_RMS_Max.	Blindleistung Q3 RMS Max. [A] über die letzten "Sekunden für den Max. RMS"	Float	R	
40605	Q3_RMS_Min.	Blindleistung Q3 RMS Min. [A] über die letzten "Sekunden für den Min. RMS"	Float	R	
40607	Q-SUM_RMS_AVG	Blindleistung Q Summe RMS Durchschnitt [A] über "Sekunden für den Mittelwert RMS"	Float	R	
40609	Q_SUM_RMS_Max.	Blindleistung Q Summe RMS Max. [A] über die letzten "Sekunden für den Max. RMS"	Float	R	
40611	Q_SUM_RMS_Min.	Blindleistung Q Summe RMS Min. [A] über die letzten "Sekunden für den Min. RMS"	Float	R	
40613	S1_RMS_AVG	Scheinleistung S1 RMS Durchschnitt [A] über "Sekunden für den Mittelwert RMS"	Float	R	
40615	S1_RMS_Max.	Scheinleistung S1 RMS Max. [A] über die letzten "Sekunden für den Max. RMS"	Float	R	
40617	S1_RMS_Min.	Scheinleistung S1 RMS Min. [A] über die letzten "Sekunden für den Min. RMS"	Float	R	
40619	S2_RMS_AVG	Scheinleistung S2 RMS Durchschnitt [A] über "Sekunden für den Mittelwert RMS"	Float	R	
40621	S2_RMS_Max.	Scheinleistung S2 RMS Max. [A] über die letzten "Sekunden für den Max. RMS"	Float	R	
40623	S2_RMS_Min.	Scheinleistung S2 RMS Min. [A] über die letzten "Sekunden für den Min. RMS"	Float	R	

40625	S3_RMS_AVG	Scheinleistung S3 RMS Durchschnitt [A] über "Sekunden für den Mittelwert RMS"	Float	R	
40627	S3_RMS_Max.	Scheinleistung S3 RMS Max. [A] über die letzten "Sekunden für den Max. RMS"	Float	R	
40629	S3_RMS_Min.	Scheinleistung S3 RMS Min. [A] über die letzten "Sekunden für den Min. RMS"	Float	R	
40631	S-SUM_RMS_AVG	Scheinleistung S Summe RMS Durchschnitt [A] über "Sekunden für den Mittelwert RMS"	Float	R	
40633	S_SUM_RMS_Max.	Scheinleistung S Summe RMS Max. [A] über die letzten "Sekunden für den Max. RMS"	Float	R	
40635	S_SUM_RMS_Min.	Scheinleistung S Summe RMS Min. [A] über die letzten "Sekunden für den Min. RMS"	Float	R	
40637	PF1_RMS_AVG	Leistungsfaktor PF1 RMS Durchschnitt [A] über "Sekunden für den Mittelwert RMS"	Float	R	
40639	PF1_RMS_Max.	Leistungsfaktor PF1 RMS Max. [A] über die letzten "Sekunden für den Max. RMS"	Float	R	
40641	PF1_RMS_Min.	Leistungsfaktor PF1 RMS Min. [A] über die letzten "Sekunden für den Min. RMS"	Float	R	
40643	PF2_RMS_AVG	Leistungsfaktor PF2 RMS Durchschnitt [A] über "Sekunden für den Mittelwert RMS"	Float	R	
40645	PF2_RMS_Max.	Leistungsfaktor PF2 RMS Max. [A] über die letzten "Sekunden für den Max. RMS"	Float	R	
40647	PF2_RMS_Min.	Leistungsfaktor PF2 RMS Min. [A] über die letzten "Sekunden für den Min. RMS"	Float	R	
40649	PF3_RMS_AVG	Leistungsfaktor PF3 RMS Durchschnitt [A] über "Sekunden für den Mittelwert RMS"	Float	R	
40651	PF3_RMS_Max.	Leistungsfaktor PF3 RMS Max. [A] über die letzten "Sekunden für den Max. RMS"	Float	R	
40653	PF3_RMS_Min.	Leistungsfaktor PF3 RMS Min. [A] über die letzten "Sekunden für den Min. RMS"	Float	R	
40655	PF_SUM_RMS_AVG	Leistungsfaktor PF Summe RMS Durchschnitt [A] über "Sekunden für den Mittelwert RMS"	Float	R	
40657	PF_SUM_RMS_Max.	Leistungsfaktor PF Summe RMS Max. [A] über die letzten "Sekunden für den Max. RMS"	Float	R	
40659	PF_SUM_RMS_Min.	Leistungsfaktor PF Summe RMS Min. [A] über die letzten "Sekunden für den Min. RMS"	Float	R	
40661	P1_Zeit_über_Schwelle	Zeit über der Schwelle, die unter "Leistungsschwelle für Überschreitungen" für Wirkleistung P1 angegeben ist [min]	Float	R	
40663	P2_Zeit_über_Schwelle	Zeit über der Schwelle, die unter "Leistungsschwelle für Überschreitungen" für Wirkleistung P2 angegeben ist [min]	Float	R	
40665	P3_Zeit_über_Schwelle	Zeit über der Schwelle, die unter "Leistungsschwelle für Überschreitungen" für Wirkleistung P3 angegeben ist [min]	Float	R	
40667	P_SUM_Zeit_über_Schwelle	Zeit über der Schwelle, die unter "Leistungsschwelle für Überschreitungen" für Wirkleistung P_SUM angegeben ist [min]	Float	R	
40669	P1_MaxDemand	Max. Bedarf über 15 Minuten für P1 für den aktuellen Monat	Float	R	
40671	P2_MaxDemand	Max. Bedarf über 15 Minuten für P2 für den aktuellen Monat	Float	R	
40673	P3_MaxDemand	Max. Bedarf über 15 Minuten für P3 für den aktuellen Monat	Float	R	
40675	P_SUM_MaxDemand	Max Nachfrage über 15 Minuten für P drei Phasen für aktuellen Monat	Float	R	
40677	Zeit_von_P1_MaxDemand	Zeit, zu der Max-Bedarf über 15 Minuten für P1 für aktuellen Monat entsteht (Monat, Tag, Stunden, Minuten)	Unsigned long	R	
40679	Zeit_von_P2_MaxDemand	Zeit, zu der Max-Bedarf über 15 Minuten für P2 für aktuellen Monat entsteht (Monat, Tag, Stunden, Minuten)	Unsigned long	R	
40681	Zeit_von_P3_MaxDemand	Zeit, zu der Max-Bedarf über 15 Minuten für P3 für aktuellen Monat entsteht (Monat, Tag, Stunden, Minuten)	Unsigned long	R	
40683	Zeit_von_P_SUM_MaxDemand	Zeit, zu der Max-Bedarf über 15 Minuten für P drei Phasen für aktuellen Monat entsteht (Monat, Tag, Stunden, Minuten)	Unsigned long	R	
40685	K_Faktor_I1	K-Faktor für L1, (IEEE Standard 1100-1992)	Float	R	

40687	K_Faktor_I2	K-Faktor für L2, (IEEE Standard 1100-1992)	Float	R	
40689	K_Faktor_I3	K-Faktor für L3, (IEEE Standard 1100-1992)	Float	R	
40691	Jahr	RTC: Jahr (2000...2099)	Unsigned short	R/W	
40692	Monat	RTC: Monat (1...12)	Unsigned short	R/W	
40693	Tag	RTC: Tag (1...31)	Unsigned short	R/W	
40694	Stunden	RTC: Stunden (0...23)	Unsigned short	R/W	
40695	Minuten	RTC: Minuten (0...59)	Unsigned short	R/W	
40696	Sekunden	RTC: Sekunden (0...59)	Unsigned short	R/W	
40697	THD_U_L1	THD Sternspannung L1	Float	R	
40699	THD_U_L2	THD Sternspannung L2	Float	R	
40701	THD_U_L3	THD Sternspannung L3	Float	R	
40703	THD_U_L12	THD Nennspannung L1-L2	Float	R	
40705	THD_U_L23	THD Nennspannung L2-L3	Float	R	
40707	THD_U_L31	THD Nennspannung L3-L1	Float	R	
40709	THD_I_L1	THD Strom L1	Float	R	
40711	THD_I_L2	THD Strom L2	Float	R	
40713	THD_I_L3	THD Strom L3	Float	R	
40715	THD_I_N	THD Strom N	Float	R	
40717	TDD_I_L1	TDD Strom L1	Float	R	
40719	TDD_I_L2	TDD Strom L2	Float	R	
40721	TDD_I_L3	TDD Strom L3	Float	R	
40737 bis 40863	U_L1N_H_0...63	Sternspannung L1-N Harmonische 0 bis 63	Float	R	
40865 bis 40991	U_L2N_H_0...63	Sternspannung L2-N Harmonische 0 bis 63	Float	R	
40993 bis 41119	U_L3N_H_0...63	Sternspannung L3-N Harmonische 0 bis 63	Float	R	
41121 bis 41247	U_L12_H_0...63	Nennspannung L1-L2 Harmonische 0 bis 63	Float	R	
41249 bis 41375	U_L23_H_0...63	Nennspannung L2_L3 Harmonische 0 bis 63	Float	R	
41377 bis 41503	U_L31_H_0...63	Nennspannung L3-L1 Harmonische 0 bis 63	Float	R	
41507 bis 41631	I_L1_H_0...63	Strom L1 Harmonische 0 bis 63	Float	R	
41633 bis 41759	I_L2_H_0...63	Strom L2 Harmonische 0 bis 63	Float	R	
41761 bis 41887	I_L3_H_0...63	Strom L3 Harmonische 0 bis 63	Float	R	
41889 bis 42015	I_N_H_0...63	Strom N Harmonische 0 bis 63	Float	R	
42017 bis 42143	U_L1N_IH_0...63	Sternspannung L1-N Interharmonische 0 bis 63	Float	R	
42145 bis 42271	U_L2N_IH_0...63	Sternspannung L2-N Interharmonische 0 bis 63	Float	R	
42273 bis 42399	U_L3N_IH_0...63	Sternspannung L3-N Interharmonische 0 bis 63	Float	R	
42401 bis 42527	U_L12_IH_0...63	Nennspannung L1-L2 Interharmonische 0 bis 63	Float	R	
42529 bis 42655	U_L23_IH_0...63	Nennspannung L2-L3 Interharmonische 0 bis 63	Float	R	
42657 bis 42783	U_L31_IH_0...63	Nennspannung L3-L1 Interharmonische 0 bis 63	Float	R	
42785 bis 42911	I_L1_IH_0...63	Strom L1 Interharmonische 0 bis 63	Float	R	
42913 bis 43039	I_L2_IH_0...63	Strom L2 Interharmonische 0 bis 63	Float	R	
43041 bis 43167	I_L3_IH_0...63	Strom L3 Interharmonische 0 bis 63	Float	R	
43169 bis 43295	I_N_IH_0...63	Strom N Interharmonische 0 bis 63	Float	R	
43297	U_SAG_Wert_N_0	Spannung SAG RMS-Wert (zwischen 10% und 90% "Nenn-sternspannung") @ n-0	Float	R	
43299	U_SAG_Jahr_N_0	Spannung SAG Jahr @ n-0	Unsigned short	R	

43300	U_SAG_Monat_N_0	Spannung SAG Monat @ n-0	Unsigned short	R	
43301	U_SAG_Tag_N_0	Spannung SAG Tag @ n-0	Unsigned short	R	
43302	U_SAG_Stunden_N_0	Spannung SAG Stunden @ n-0	Unsigned short	R	
43303	U_SAG_Minuten_N_0	Spannung SAG Minuten @ n-0	Unsigned short	R	
43304	U_SAG_Sekunden_N_0	Spannung SAG Sekunden @ n-0	Unsigned short	R	
43305	U_SAG_Dauer_N_0	Spannung SAG Dauer [ms] @ n-0	Unsigned short	R	
43306	U_SAG_Query_N_0	Spannung SAG Typ: 0: ND 1: U_L1N 2: U_L2N 3: U_L3N 4: U_L1L2 5: U_L2L3 6: U_L3L1	Unsigned short	R	
43307	U_SAG_Wert_N_1	Spannung SAG RMS-Wert (zwischen 10% und 90% "Nenn-sternspannung") @ n-1	Float	R	
43309	U_SAG_Jahr_N_1	Spannung SAG Jahr @ n-1	Unsigned short	R	
43310	U_SAG_Monat_N_1	Spannung SAG Monat @ n-1	Unsigned short	R	
43311	U_SAG_Tag_N_1	Spannung SAG Tag @ n-1	Unsigned short	R	
43312	U_SAG_Stunden_N_1	Spannung SAG Stunden @ n-1	Unsigned short	R	
43313	U_SAG_Minuten_N_1	Spannung SAG Minuten @ n-1	Unsigned short	R	
43314	U_SAG_Sekunden_N_1	Spannung SAG Sekunden @ n-1	Unsigned short	R	
43315	U_SAG_Dauer_N_1	Spannung SAG Dauer [ms] @ n-1	Unsigned short	R	
43316	U_SAG_Query_N_1	Spannung SAG Typ: 0: ND 1: U_L1N 2: U_L2N 3: U_L3N 4: U_L1L2 5: U_L2L3 6: U_L3L1	Unsigned short	R	
43317	U_SAG_Wert_N_2	Spannung SAG RMS-Wert (zwischen 10% und 90% "Nenn-sternspannung") @ n-2	Float	R	
43319	U_SAG_Jahr_N_2	Spannung SAG Jahr @ n-2	Unsigned short	R	
43320	U_SAG_Monat_N_2	Spannung SAG Monat @ n-2	Unsigned short	R	
43321	U_SAG_Tag_N_2	Spannung SAG Tag @ n-2	Unsigned short	R	
43322	U_SAG_Stunden_N_2	Spannung SAG Stunden @ n-2	Unsigned short	R	
43323	U_SAG_Minuten_N_2	Spannung SAG Minuten @ n-2	Unsigned short	R	
43324	U_SAG_Sekunden_N_2	Spannung SAG Sekunden @ n-2	Unsigned short	R	
43325	U_SAG_Dauer_N_2	Spannung SAG Dauer [ms] @ n-2	Unsigned short	R	
43326	U_SAG_Query_N_2	Spannung SAG Typ: 0: ND 1: U_L1N 2: U_L2N 3: U_L3N 4: U_L1L2 5: U_L2L3 6: U_L3L1	Unsigned short	R	
43327	U_SAG_Wert_N_3	Spannung SAG RMS-Wert (zwischen 10% und 90% "Nenn-sternspannung") @ n-3	Float	R	
43329	U_SAG_Jahr_N_3	Spannung SAG Jahr @ n-3	Unsigned short	R	
43330	U_SAG_Monat_N_3	Spannung SAG Monat @ n-3	Unsigned short	R	
43331	U_SAG_Tag_N_3	Spannung SAG Tag @ n-3	Unsigned short	R	
43332	U_SAG_Stunden_N_3	Spannung SAG Stunden @ n-3	Unsigned short	R	
43333	U_SAG_Minuten_N_3	Spannung SAG Minuten @ n-3	Unsigned short	R	
43334	U_SAG_Sekunden_N_3	Spannung SAG Sekunden @ n-3	Unsigned short	R	
43335	U_SAG_Dauer_N_3	Spannung SAG Dauer [ms] @ n-3	Unsigned short	R	
43336	U_SAG_Query_N_3	Spannung SAG Typ: 0: ND 1: U_L1N 2: U_L2N 3: U_L3N 4: U_L1L2 5: U_L2L3 6: U_L3L1	Unsigned short	R	

43337	U_SAG_Wert_N_4	Spannung SAG RMS-Wert (zwischen 10% und 90% "Nenn-sternspannung") @ n-4	Float	R	
43339	U_SAG_Jahr_N_4	Spannung SAG Jahr @ n-4	Unsigned short	R	
43340	U_SAG_Monat_N_4	Spannung SAG Monat @ n-4	Unsigned short	R	
43341	U_SAG_Tag_N_4	Spannung SAG Tag @ n-4	Unsigned short	R	
43342	U_SAG_Stunden_N_4	Spannung SAG Stunden @ n-4	Unsigned short	R	
43343	U_SAG_Minuten_N_4	Spannung SAG Minuten @ n-4	Unsigned short	R	
43344	U_SAG_Sekunden_N_4	Spannung SAG Sekunden @ n-4	Unsigned short	R	
43345	U_SAG_Dauer_N_4	Spannung SAG Dauer [ms] @ n-4	Unsigned short	R	
43346	U_SAG_Query_N_4	Spannung SAG Typ: 0: ND 1: U_L1N 2: U_L2N 3: U_L3N 4: U_L1L2 5: U_L2L3 6: U_L3L1	Unsigned short	R	
43347	U_SAG_Wert_N_5	Spannung SAG RMS-Wert (zwischen 10% und 90% "Nenn-sternspannung") @ n-5	Float	R	
43349	U_SAG_Jahr_N_5	Spannung SAG Jahr @ n-5	Unsigned short	R	
43350	U_SAG_Monat_N_5	Spannung SAG Monat @ n-5	Unsigned short	R	
43351	U_SAG_Tag_N_5	Spannung SAG Tag @ n-5	Unsigned short	R	
43352	U_SAG_Stunden_N_5	Spannung SAG Stunden @ n-5	Unsigned short	R	
43353	U_SAG_Minuten_N_5	Spannung SAG Minuten @ n-5	Unsigned short	R	
43354	U_SAG_Sekunden_N_5	Spannung SAG Sekunden @ n-5	Unsigned short	R	
43355	U_SAG_Dauer_N_5	Spannung SAG Dauer [ms] @ n-5	Unsigned short	R	
43356	U_SAG_Query_N_5	Spannung SAG Typ: 0: ND 1: U_L1N 2: U_L2N 3: U_L3N 4: U_L1L2 5: U_L2L3 6: U_L3L1	Unsigned short	R	
43357	U_SAG_Wert_N_6	Spannung SAG RMS-Wert (zwischen 10% und 90% "Nenn-sternspannung") @ n-6	Float	R	
43359	U_SAG_Jahr_N_6	Spannung SAG Jahr @ n-6	Unsigned short	R	
43360	U_SAG_Monat_N_6	Spannung SAG Monat @ n-6	Unsigned short	R	
43361	U_SAG_Tag_N_6	Spannung SAG Tag @ n-6	Unsigned short	R	
43362	U_SAG_Stunden_N_6	Spannung SAG Stunden @ n-6	Unsigned short	R	
43363	U_SAG_Minuten_N_6	Spannung SAG Minuten @ n-6	Unsigned short	R	
43364	U_SAG_Sekunden_N_6	Spannung SAG Sekunden @ n-6	Unsigned short	R	
43365	U_SAG_Dauer_N_6	Spannung SAG Dauer [ms] @ n-6	Unsigned short	R	
43366	U_SAG_Query_N_6	Spannung SAG Typ: 0: ND 1: U_L1N 2: U_L2N 3: U_L3N 4: U_L1L2 5: U_L2L3 6: U_L3L1	Unsigned short	R	
43367	U_SAG_Wert_N_7	Spannung SAG RMS-Wert (zwischen 10% und 90% "Nenn-sternspannung") @ n-7	Float	R	
43369	U_SAG_Jahr_N_7	Spannung SAG Jahr @ n-7	Unsigned short	R	
43370	U_SAG_Monat_N_7	Spannung SAG Monat @ n-7	Unsigned short	R	
43371	U_SAG_Tag_N_7	Spannung SAG Tag @ n-7	Unsigned short	R	
43372	U_SAG_Stunden_N_7	Spannung SAG Stunden @ n-7	Unsigned short	R	
43373	U_SAG_Minuten_N_7	Spannung SAG Minuten @ n-7	Unsigned short	R	
43374	U_SAG_Sekunden_N_7	Spannung SAG Sekunden @ n-7	Unsigned short	R	
43375	U_SAG_Dauer_N_7	Spannung SAG Dauer [ms] @ n-7	Unsigned short	R	

43376	U_SAG_Query_N_7	Spannung SAG Typ: 0: ND 1: U_L1N 2: U_L2N 3: U_L3N 4: U_L1L2 5: U_L2L3 6: U_L3L1	Unsigned short	R	
43377	U_SAG_Wert_N_8	Spannung SAG RMS-Wert (zwischen 10% und 90% "Nenn-sternspannung") @ n-8	Float	R	
43379	U_SAG_Jahr_N_8	Spannung SAG Jahr @ n-8	Unsigned short	R	
43380	U_SAG_Monat_N_8	Spannung SAG Monat @ n-8	Unsigned short	R	
43381	U_SAG_Tag_N_8	Spannung SAG Tag @ n-8	Unsigned short	R	
43382	U_SAG_Stunden_N_8	Spannung SAG Stunden @ n-8	Unsigned short	R	
43383	U_SAG_Minuten_N_8	Spannung SAG Minuten @ n-8	Unsigned short	R	
43384	U_SAG_Sekunden_N_8	Spannung SAG Sekunden @ n-8	Unsigned short	R	
43385	U_SAG_Dauer_N_8	Spannung SAG Dauer [ms] @ n-8	Unsigned short	R	
43386	U_SAG_Query_N_8	Spannung SAG Typ: 0: ND 1: U_L1N 2: U_L2N 3: U_L3N 4: U_L1L2 5: U_L2L3 6: U_L3L1	Unsigned short	R	
43387	U_SAG_Wert_N_9	Spannung SAG RMS-Wert (zwischen 10% und 90% "Nenn-sternspannung") @ n-9	Float	R	
43389	U_SAG_Jahr_N_9	Spannung SAG Jahr @ n-9	Unsigned short	R	
43390	U_SAG_Monat_N_9	Spannung SAG Monat @ n-9	Unsigned short	R	
43391	U_SAG_Tag_N_9	Spannung SAG Tag @ n-9	Unsigned short	R	
43392	U_SAG_Stunden_N_9	Spannung SAG Stunden @ n-9	Unsigned short	R	
43393	U_SAG_Minuten_N_9	Spannung SAG Minuten @ n-9	Unsigned short	R	
43394	U_SAG_Sekunden_N_9	Spannung SAG Sekunden @ n-9	Unsigned short	R	
43395	U_SAG_Dauer_N_9	Spannung SAG Dauer [ms] @ n-9	Unsigned short	R	
43396	U_SAG_Query_N_9	Spannung SAG Typ: 0: ND 1: U_L1N 2: U_L2N 3: U_L3N 4: U_L1L2 5: U_L2L3 6: U_L3L1	Unsigned short	R	
43397	U_SAG_Wert_EEPROM	Spannung SAG RMS-Wert (zwischen 10% und 90% "Nenn-sternspannung") EEPROM Daten	Float	R	
43399	U_SAG_Jahr_EEPROM	Spannung SAG Jahr EEPROM Daten	Unsigned short	R	
43400	U_SAG_Monat_EEPROM	Spannung SAG Monat EEPROM Daten	Unsigned short	R	
43401	U_SAG_Tag_EEPROM	Spannung SAG Tag EEPROM Daten	Unsigned short	R	
43402	U_SAG_Stunden_EEPROM	Spannung SAG Stunden EEPROM Daten	Unsigned short	R	
43403	U_SAG_Minuten_EEPROM	Spannung SAG Minuten EEPROM Daten	Unsigned short	R	
43404	U_SAG_Sekunden_EEPROM	Spannung SAG Sekunden EEPROM Daten	Unsigned short	R	
43405	U_SAG_Dauer_EEPROM	Spannung SAG Dauer [ms] EEPROM Daten	Unsigned short	R	
43406	U_SAG_Query_EEPROM	Spannung SAG Typ: 0: ND 1: U_L1N 2: U_L2N 3: U_L3N 4: U_L1L2 5: U_L2L3 6: U_L3L1	Unsigned short	R	
43407	U_SWELL_Wert_N_0	Spannung Swell RMS-Wert (zwischen 10% und 90% "Nenn-sternspannung") @ n-0	Float	R	
43409	U_SWELL_Jahr_N_0	Spannung Swell Jahr @ n-0	Unsigned short	R	
43410	U_SWELL_Monat_N_0	Spannung Swell Monat @ n-0	Unsigned short	R	
43411	U_SWELL_Tag_N_0	Spannung Swell Tag @ n-0	Unsigned short	R	
43412	U_SWELL_Stunden_N_0	Spannung Swell Stunden @ n-0	Unsigned short	R	

43413	U_SWELL_Minuten_N_0	Spannung Swell Minuten @ n-0	Unsigned short	R	
43414	U_SWELL_Sekunden_N_0	Spannung Swell Sekunden @ n-0	Unsigned short	R	
43415	U_SWELL_Dauer_N_0	Spannung Swell Dauer [ms] @ n-0	Unsigned short	R	
43416	U_SWELL_Query_N_0	Spannung Swell Typ: 0: ND 1: U_L1N 2: U_L2N 3: U_L3N 4: U_L1L2 5: U_L2L3 6: U_L3L1	Unsigned short	R	
43417	U_SWELL_Wert_N_1	Spannung Swell RMS-Wert (zwischen 10% und 90% "Nenn-sternspannung") @ n-1	Float	R	
43419	U_SWELL_Jahr_N_1	Spannung Swell Jahr @ n-1	Unsigned short	R	
43420	U_SWELL_Monat_N_1	Spannung Swell Monat @ n-1	Unsigned short	R	
43421	U_SWELL_Tag_N_1	Spannung Swell Tag @ n-1	Unsigned short	R	
43422	U_SWELL_Stunden_N_1	Spannung Swell Stunden @ n-1	Unsigned short	R	
43423	U_SWELL_Minuten_N_1	Spannung Swell Minuten @ n-1	Unsigned short	R	
43424	U_SWELL_Sekunden_N_1	Spannung Swell Sekunden @ n-1	Unsigned short	R	
43425	U_SWELL_Dauer_N_1	Spannung Swell Dauer [ms] @ n-1	Unsigned short	R	
43426	U_SWELL_Query_N_1	Spannung Swell Typ: 0: ND 1: U_L1N 2: U_L2N 3: U_L3N 4: U_L1L2 5: U_L2L3 6: U_L3L1	Unsigned short	R	
43427	U_SWELL_Wert_N_2	Spannung Swell RMS-Wert (zwischen 10% und 90% "Nenn-sternspannung") @ n-2	Float	R	
43429	U_SWELL_Jahr_N_2	Spannung Swell Jahr @ n-2	Unsigned short	R	
43430	U_SWELL_Monat_N_2	Spannung Swell Monat @ n-2	Unsigned short	R	
43431	U_SWELL_Tag_N_2	Spannung Swell Tag @ n-2	Unsigned short	R	
43432	U_SWELL_Stunden_N_2	Spannung Swell Stunden @ n-2	Unsigned short	R	
43433	U_SWELL_Minuten_N_2	Spannung Swell Minuten @ n-2	Unsigned short	R	
43434	U_SWELL_Sekunden_N_2	Spannung Swell Sekunden @ n-2	Unsigned short	R	
43435	U_SWELL_Dauer_N_2	Spannung Swell Dauer [ms] @ n-2	Unsigned short	R	
43436	U_SWELL_Query_N_2	Spannung Swell Typ: 0: ND 1: U_L1N 2: U_L2N 3: U_L3N 4: U_L1L2 5: U_L2L3 6: U_L3L1	Unsigned short	R	
43437	U_SWELL_Wert_N_3	Spannung Swell RMS-Wert (zwischen 10% und 90% "Nenn-sternspannung") @ n-3	Float	R	
43439	U_SWELL_Jahr_N_3	Spannung Swell Jahr @ n-3	Unsigned short	R	
43440	U_SWELL_Monat_N_3	Spannung Swell Monat @ n-3	Unsigned short	R	
43441	U_SWELL_Tag_N_3	Spannung Swell Tag @ n-3	Unsigned short	R	
43442	U_SWELL_Stunden_N_3	Spannung Swell Stunden @ n-3	Unsigned short	R	
43443	U_SWELL_Minuten_N_3	Spannung Swell Minuten @ n-3	Unsigned short	R	
43444	U_SWELL_Sekunden_N_3	Spannung Swell Sekunden @ n-3	Unsigned short	R	
43445	U_SWELL_Dauer_N_3	Spannung Swell Dauer [ms] @ n-3	Unsigned short	R	
43446	U_SWELL_Query_N_3	Spannung Swell Typ: 0: ND 1: U_L1N 2: U_L2N 3: U_L3N 4: U_L1L2 5: U_L2L3 6: U_L3L1	Unsigned short	R	
43447	U_SWELL_Wert_N_4	Spannung Swell RMS-Wert (zwischen 10% und 90% "Nenn-sternspannung") @ n-4	Float	R	
43449	U_SWELL_Jahr_N_4	Spannung Swell Jahr @ n-4	Unsigned short	R	

43450	U_SWELL_Monat_N_4	Spannung Swell Monat @ n-4	Unsigned short	R	
43451	U_SWELL_Tag_N_4	Spannung Swell Tag @ n-4	Unsigned short	R	
43452	U_SWELL_Stunden_N_4	Spannung Swell Stunden @ n-4	Unsigned short	R	
43453	U_SWELL_Minuten_N_4	Spannung Swell Minuten @ n-4	Unsigned short	R	
43454	U_SWELL_Sekunden_N_4	Spannung Swell Sekunden @ n-4	Unsigned short	R	
43455	U_SWELL_Dauer_N_4	Spannung Swell Dauer [ms] @ n-4	Unsigned short	R	
43456	U_SWELL_Query_N_4	Spannung Swell Typ: 0: ND 1: U_L1N 2: U_L2N 3: U_L3N 4: U_L1L2 5: U_L2L3 6: U_L3L1	Unsigned short	R	
43457	U_SWELL_Wert_N_5	Spannung Swell RMS-Wert (zwischen 10% und 90% "Nenn-sternspannung") @ n-5	Float	R	
43459	U_SWELL_Jahr_N_5	Spannung Swell Jahr @ n-5	Unsigned short	R	
43460	U_SWELL_Monat_N_5	Spannung Swell Monat @ n-5	Unsigned short	R	
43461	U_SWELL_Tag_N_5	Spannung Swell Tag @ n-5	Unsigned short	R	
43462	U_SWELL_Stunden_N_5	Spannung Swell Stunden @ n-5	Unsigned short	R	
43463	U_SWELL_Minuten_N_5	Spannung Swell Minuten @ n-5	Unsigned short	R	
43464	U_SWELL_Sekunden_N_5	Spannung Swell Sekunden @ n-5	Unsigned short	R	
43465	U_SWELL_Dauer_N_5	Spannung Swell Dauer [ms] @ n-5	Unsigned short	R	
43466	U_SWELL_Query_N_5	Spannung Swell Typ: 0: ND 1: U_L1N 2: U_L2N 3: U_L3N 4: U_L1L2 5: U_L2L3 6: U_L3L1	Unsigned short	R	
43467	U_SWELL_Wert_N_6	Spannung Swell RMS-Wert (zwischen 10% und 90% "Nenn-sternspannung") @ n-6	Float	R	
43469	U_SWELL_Jahr_N_6	Spannung Swell Jahr @ n-6	Unsigned short	R	
43470	U_SWELL_Monat_N_6	Spannung Swell Monat @ n-6	Unsigned short	R	
43471	U_SWELL_Tag_N_6	Spannung Swell Tag @ n-6	Unsigned short	R	
43472	U_SWELL_Stunden_N_6	Spannung Swell Stunden @ n-6	Unsigned short	R	
43473	U_SWELL_Minuten_N_6	Spannung Swell Minuten @ n-6	Unsigned short	R	
43474	U_SWELL_Sekunden_N_6	Spannung Swell Sekunden @ n-6	Unsigned short	R	
43475	U_SWELL_Dauer_N_6	Spannung Swell Dauer [ms] @ n-6	Unsigned short	R	
43476	U_SWELL_Query_N_6	Spannung Swell Typ: 0: ND 1: U_L1N 2: U_L2N 3: U_L3N 4: U_L1L2 5: U_L2L3 6: U_L3L1	Unsigned short	R	
43477	U_SWELL_Wert_N_7	Spannung Swell RMS-Wert (zwischen 10% und 90% "Nenn-sternspannung") @ n-7	Float	R	
43479	U_SWELL_Jahr_N_7	Spannung Swell Jahr @ n-7	Unsigned short	R	
43480	U_SWELL_Monat_N_7	Spannung Swell Monat @ n-7	Unsigned short	R	
43481	U_SWELL_Tag_N_7	Spannung Swell Tag @ n-7	Unsigned short	R	
43482	U_SWELL_Stunden_N_7	Spannung Swell Stunden @ n-7	Unsigned short	R	
43483	U_SWELL_Minuten_N_7	Spannung Swell Minuten @ n-7	Unsigned short	R	
43484	U_SWELL_Sekunden_N_7	Spannung Swell Sekunden @ n-7	Unsigned short	R	
43485	U_SWELL_Dauer_N_7	Spannung Swell Dauer [ms] @ n-7	Unsigned short	R	
43486	U_SWELL_Query_N_7	Spannung Swell Typ: 0: ND 1: U_L1N 2: U_L2N 3: U_L3N 4: U_L1L2 5: U_L2L3 6: U_L3L1	Unsigned short	R	

43487	U_SWELL_Wert_N_8	Spannung Swell RMS-Wert (zwischen 10% und 90% "Nenn-sternspannung") @ n-8	Float	R	
43489	U_SWELL_Jahr_N_8	Spannung Swell Jahr @ n-8	Unsigned short	R	
43490	U_SWELL_Monat_N_8	Spannung Swell Monat @ n-8	Unsigned short	R	
43491	U_SWELL_Tag_N_8	Spannung Swell Tag @ n-8	Unsigned short	R	
43492	U_SWELL_Stunden_N_8	Spannung Swell Stunden @ n-8	Unsigned short	R	
43493	U_SWELL_Minuten_N_8	Spannung Swell Minuten @ n-8	Unsigned short	R	
43494	U_SWELL_Sekunden_N_8	Spannung Swell Sekunden @ n-8	Unsigned short	R	
43495	U_SWELL_Dauer_N_8	Spannung Swell Dauer [ms] @ n-8	Unsigned short	R	
43496	U_SWELL_Query_N_8	Spannung Swell Typ: 0: ND 1: U_L1N 2: U_L2N 3: U_L3N 4: U_L1L2 5: U_L2L3 6: U_L3L1	Unsigned short	R	
43497	U_SWELL_Wert_N_9	Spannung Swell RMS-Wert (zwischen 10% und 90% "Nenn-sternspannung") @ n-9	Float	R	
43499	U_SWELL_Jahr_N_9	Spannung Swell Jahr @ n-9	Unsigned short	R	
43500	U_SWELL_Monat_N_9	Spannung Swell Monat @ n-9	Unsigned short	R	
43501	U_SWELL_Tag_N_9	Spannung Swell Tag @ n-9	Unsigned short	R	
43502	U_SWELL_Stunden_N_9	Spannung Swell Stunden @ n-9	Unsigned short	R	
43503	U_SWELL_Minuten_N_9	Spannung Swell Minuten @ n-9	Unsigned short	R	
43504	U_SWELL_Sekunden_N_9	Spannung Swell Sekunden @ n-9	Unsigned short	R	
43505	U_SWELL_Dauer_N_9	Spannung Swell Dauer [ms] @ n-9	Unsigned short	R	
43506	U_SWELL_Query_N_9	Spannung Swell Typ: 0: ND 1: U_L1N 2: U_L2N 3: U_L3N 4: U_L1L2 5: U_L2L3 6: U_L3L1	Unsigned short	R	
43507	U_SWELL_Wert_EEPROM	Spannung Swell RMS-Wert (zwischen 10% und 90% "Nenn-sternspannung") EEPROM Daten	Float	R	
43509	U_SWELL_Jahr_EEPROM	Spannung Swell Jahr EEPROM Daten	Unsigned short	R	
43510	U_SWELL_Monat_EEPROM	Spannung Swell Monat EEPROM Daten	Unsigned short	R	
43511	U_SWELL_Tag_EEPROM	Spannung Swell Tag EEPROM Daten	Unsigned short	R	
43512	U_SWELL_Stunden_EEPROM	Spannung Swell Stunden EEPROM Daten	Unsigned short	R	
43513	U_SWELL_Minuten_EEPROM	Spannung Swell Minuten EEPROM Daten	Unsigned short	R	
43514	U_SWELL_Sekunden_EEPROM	Spannung Swell Sekunden EEPROM Daten	Unsigned short	R	
43515	U_SWELL_Dauer_EEPROM	Spannung Swell Dauer [ms] EEPROM Daten	Unsigned short	R	
43516	U_SWELL_Query_EEPROM	Spannung Swell Typ: 0: ND 1: U_L1N 2: U_L2N 3: U_L3N 4: U_L1L2 5: U_L2L3 6: U_L3L1	Unsigned short	R	
43517	U_Unterbrechung_Wert_N_0	Spannung Unterbrechung RMS-Wert (zwischen 10% und 90% "Nenn-sternspannung") @ n-0	Float	R	
43519	U_Unterbrechung_Jahr_N_0	Spannung Unterbrechung Jahr @ n-0	Unsigned short	R	
43520	U_Unterbrechung_Monat_N_0	Spannung Unterbrechung Monat @ n-0	Unsigned short	R	
43521	U_Unterbrechung_Tag_N_0	Spannung Unterbrechung Tag @ n-0	Unsigned short	R	
43522	U_Unterbrechung_Stunden_N_0	Spannung Unterbrechung Stunden @ n-0	Unsigned short	R	
43523	U_Unterbrechung_Minuten_N_0	Spannung Unterbrechung Minuten @ n-0	Unsigned short	R	
43524	U_Unterbrechung_Sekunden_N_0	Spannung Unterbrechung Sekunden @ n-0	Unsigned short	R	

43525	U_Unterbrechung_Dauer_N_0	Spannung Unterbrechung Dauer [ms] @ n-0	Unsigned short	R	
43526	U_Unterbrechung_Query_N_0	Spannung Unterbrechung Typ: 0: ND 1: U_L1N 2: U_L2N 3: U_L3N 4: U_L1L2 5: U_L2L3 6: U_L3L1	Unsigned short	R	
43527	U_Unterbrechung_Wert_N_1	Spannung Unterbrechung RMS-Wert (zwischen 10% und 90% "Nenn-sternspannung") @ n-1	Float	R	
43529	U_Unterbrechung_Jahr_N_1	Spannung Unterbrechung Jahr @ n-1	Unsigned short	R	
43530	U_Unterbrechung_Monat_N_1	Spannung Unterbrechung Monat @ n-1	Unsigned short	R	
43531	U_Unterbrechung_Tag_N_1	Spannung Unterbrechung Tag @ n-1	Unsigned short	R	
43532	U_Unterbrechung_Stunden_N_1	Spannung Unterbrechung Stunden @ n-1	Unsigned short	R	
43533	U_Unterbrechung_Minuten_N_1	Spannung Unterbrechung Minuten @ n-1	Unsigned short	R	
43534	U_Unterbrechung_Sekunden_N_1	Spannung Unterbrechung Sekunden @ n-1	Unsigned short	R	
43535	U_Unterbrechung_Dauer_N_1	Spannung Unterbrechung Dauer [ms] @ n-1	Unsigned short	R	
43536	U_Unterbrechung_Query_N_1	Spannung Unterbrechung Typ: 0: ND 1: U_L1N 2: U_L2N 3: U_L3N 4: U_L1L2 5: U_L2L3 6: U_L3L1	Unsigned short	R	
43537	U_Unterbrechung_Wert_N_2	Spannung Unterbrechung RMS-Wert (zwischen 10% und 90% "Nenn-sternspannung") @ n-2	Float	R	
43539	U_Unterbrechung_Jahr_N_2	Spannung Unterbrechung Jahr @ n-2	Unsigned short	R	
43540	U_Unterbrechung_Monat_N_2	Spannung Unterbrechung Monat @ n-2	Unsigned short	R	
43541	U_Unterbrechung_Tag_N_2	Spannung Unterbrechung Tag @ n-2	Unsigned short	R	
43542	U_Unterbrechung_Stunden_N_2	Spannung Unterbrechung Stunden @ n-2	Unsigned short	R	
43543	U_Unterbrechung_Minuten_N_2	Spannung Unterbrechung Minuten @ n-2	Unsigned short	R	
43544	U_Unterbrechung_Sekunden_N_2	Spannung Unterbrechung Sekunden @ n-2	Unsigned short	R	
43545	U_Unterbrechung_Dauer_N_2	Spannung Unterbrechung Dauer [ms] @ n-2	Unsigned short	R	
43546	U_Unterbrechung_Query_N_2	Spannung Unterbrechung Typ: 0: ND 1: U_L1N 2: U_L2N 3: U_L3N 4: U_L1L2 5: U_L2L3 6: U_L3L1	Unsigned short	R	
43547	U_Unterbrechung_Wert_N_3	Spannung Unterbrechung RMS-Wert (zwischen 10% und 90% "Nenn-sternspannung") @ n-3	Float	R	
43549	U_Unterbrechung_Jahr_N_3	Spannung Unterbrechung Jahr @ n-3	Unsigned short	R	
43550	U_Unterbrechung_Monat_N_3	Spannung Unterbrechung Monat @ n-3	Unsigned short	R	
43551	U_Unterbrechung_Tag_N_3	Spannung Unterbrechung Tag @ n-3	Unsigned short	R	

43552	U_Unterbrechung_Stunden_N_3	Spannung Unterbrechung Stunden @ n-3	Unsigned short	R	
43553	U_Unterbrechung_Minuten_N_3	Spannung Unterbrechung Minuten @ n-3	Unsigned short	R	
43554	U_Unterbrechung_Sekunden_N_3	Spannung Unterbrechung Sekunden @ n-3	Unsigned short	R	
43555	U_Unterbrechung_Dauer_N_3	Spannung Unterbrechung Dauer [ms] @ n-3	Unsigned short	R	
43556	U_Unterbrechung_Query_N_3	Spannung Unterbrechung Typ: 0: ND 1: U_L1N 2: U_L2N 3: U_L3N 4: U_L1L2 5: U_L2L3 6: U_L3L1	Unsigned short	R	
43557	U_Unterbrechung_Wert_N_4	Spannung Unterbrechung RMS-Wert (zwischen 10% und 90% "Nenn-sternspannung") @ n-4	Float	R	
43559	U_Unterbrechung_Jahr_N_4	Spannung Unterbrechung Jahr @ n-4	Unsigned short	R	
43560	U_Unterbrechung_Monat_N_4	Spannung Unterbrechung Monat @ n-4	Unsigned short	R	
43561	U_Unterbrechung_Tag_N_4	Spannung Unterbrechung Tag @ n-4	Unsigned short	R	
43562	U_Unterbrechung_Stunden_N_4	Spannung Unterbrechung Stunden @ n-4	Unsigned short	R	
43563	U_Unterbrechung_Minuten_N_4	Spannung Unterbrechung Minuten @ n-4	Unsigned short	R	
43564	U_Unterbrechung_Sekunden_N_4	Spannung Unterbrechung Sekunden @ n-4	Unsigned short	R	
43565	U_Unterbrechung_Dauer_N_4	Spannung Unterbrechung Dauer [ms] @ n-4	Unsigned short	R	
43566	U_Unterbrechung_Query_N_4	Spannung Unterbrechung Typ: 0: ND 1: U_L1N 2: U_L2N 3: U_L3N 4: U_L1L2 5: U_L2L3 6: U_L3L1	Unsigned short	R	
43567	U_Unterbrechung_Wert_N_5	Spannung Unterbrechung RMS-Wert (zwischen 10% und 90% "Nenn-sternspannung") @ n-5	Float	R	
43569	U_Unterbrechung_Jahr_N_5	Spannung Unterbrechung Jahr @ n-5	Unsigned short	R	
43570	U_Unterbrechung_Monat_N_5	Spannung Unterbrechung Monat @ n-5	Unsigned short	R	
43571	U_Unterbrechung_Tag_N_5	Spannung Unterbrechung Tag @ n-5	Unsigned short	R	
43572	U_Unterbrechung_Stunden_N_5	Spannung Unterbrechung Stunden @ n-5	Unsigned short	R	
43573	U_Unterbrechung_Minuten_N_5	Spannung Unterbrechung Minuten @ n-5	Unsigned short	R	
43574	U_Unterbrechung_Sekunden_N_5	Spannung Unterbrechung Sekunden @ n-5	Unsigned short	R	
43575	U_Unterbrechung_Dauer_N_5	Spannung Unterbrechung Dauer [ms] @ n-5	Unsigned short	R	
43576	U_Unterbrechung_Query_N_5	Spannung Unterbrechung Typ: 0: ND 1: U_L1N 2: U_L2N 3: U_L3N 4: U_L1L2 5: U_L2L3 6: U_L3L1	Unsigned short	R	
43577	U_Unterbrechung_Wert_N_6	Spannung Unterbrechung RMS-Wert (zwischen 10% und 90% "Nenn-sternspannung") @ n-6	Float	R	

43579	U_Unterbrechung_Jahr_N_6	Spannung Unterbrechung Jahr @ n-6	Unsigned short	R	
43580	U_Unterbrechung_Monat_N_6	Spannung Unterbrechung Monat @ n-6	Unsigned short	R	
43581	U_Unterbrechung_Tag_N_6	Spannung Unterbrechung Tag @ n-6	Unsigned short	R	
43582	U_Unterbrechung_Stunden_N_6	Spannung Unterbrechung Stunden @ n-6	Unsigned short	R	
43583	U_Unterbrechung_Minuten_N_6	Spannung Unterbrechung Minuten @ n-6	Unsigned short	R	
43584	U_Unterbrechung_Sekunden_N_6	Spannung Unterbrechung Sekunden @ n-6	Unsigned short	R	
43585	U_Unterbrechung_Dauer_N_6	Spannung Unterbrechung Dauer [ms] @ n-6	Unsigned short	R	
43586	U_Unterbrechung_Query_N_6	Spannung Unterbrechung Typ: 0: ND 1: U_L1N 2: U_L2N 3: U_L3N 4: U_L1L2 5: U_L2L3 6: U_L3L1	Unsigned short	R	
43587	U_Unterbrechung_Wert_N_7	Spannung Unterbrechung RMS-Wert (zwischen 10% und 90% "Nenn-sternspannung") @ n-7	Float	R	
43589	U_Unterbrechung_Jahr_N_7	Spannung Unterbrechung Jahr @ n-7	Unsigned short	R	
43590	U_Unterbrechung_Monat_N_7	Spannung Unterbrechung Monat @ n-7	Unsigned short	R	
43591	U_Unterbrechung_Tag_N_7	Spannung Unterbrechung Tag @ n-7	Unsigned short	R	
43592	U_Unterbrechung_Stunden_N_7	Spannung Unterbrechung Stunden @ n-7	Unsigned short	R	
43593	U_Unterbrechung_Minuten_N_7	Spannung Unterbrechung Minuten @ n-7	Unsigned short	R	
43594	U_Unterbrechung_Sekunden_N_7	Spannung Unterbrechung Sekunden @ n-7	Unsigned short	R	
43595	U_Unterbrechung_Dauer_N_7	Spannung Unterbrechung Dauer [ms] @ n-7	Unsigned short	R	
43596	U_Unterbrechung_Query_N_7	Spannung Unterbrechung Typ: 0: ND 1: U_L1N 2: U_L2N 3: U_L3N 4: U_L1L2 5: U_L2L3 6: U_L3L1	Unsigned short	R	
43597	U_Unterbrechung_Wert_N_8	Spannung Unterbrechung RMS-Wert (zwischen 10% und 90% "Nenn-sternspannung") @ n-8	Float	R	
43599	U_Unterbrechung_Jahr_N_8	Spannung Unterbrechung Jahr @ n-8	Unsigned short	R	
43600	U_Unterbrechung_Monat_N_8	Spannung Unterbrechung Monat @ n-8	Unsigned short	R	
43601	U_Unterbrechung_Tag_N_8	Spannung Unterbrechung Tag @ n-8	Unsigned short	R	
43602	U_Unterbrechung_Stunden_N_8	Spannung Unterbrechung Stunden @ n-8	Unsigned short	R	
43603	U_Unterbrechung_Minuten_N_8	Spannung Unterbrechung Minuten @ n-8	Unsigned short	R	
43604	U_Unterbrechung_Sekunden_N_8	Spannung Unterbrechung Sekunden @ n-8	Unsigned short	R	
43605	U_Unterbrechung_Dauer_N_8	Spannung Unterbrechung Dauer [ms] @ n-8	Unsigned short	R	

43606	U_Unterbrechung_Query_N_8	Spannung Unterbrechung Typ: 0: ND 1: U_L1N 2: U_L2N 3: U_L3N 4: U_L1L2 5: U_L2L3 6: U_L3L1	Unsigned short	R	
43607	U_Unterbrechung_Wert_N_9	Spannung Unterbrechung RMS-Wert (zwischen 10% und 90% "Nenn-sternspannung") @ n-9	Float	R	
43609	U_Unterbrechung_Jahr_N_9	Spannung Unterbrechung Jahr @ n-9	Unsigned short	R	
43610	U_Unterbrechung_Monat_N_9	Spannung Unterbrechung Monat @ n-9	Unsigned short	R	
43611	U_Unterbrechung_Tag_N_9	Spannung Unterbrechung Tag @ n-9	Unsigned short	R	
43612	U_Unterbrechung_Stunden_N_9	Spannung Unterbrechung Stunden @ n-9	Unsigned short	R	
43613	U_Unterbrechung_Minuten_N_9	Spannung Unterbrechung Minuten @ n-9	Unsigned short	R	
43614	U_Unterbrechung_Sekunden_N_9	Spannung Unterbrechung Sekunden @ n-9	Unsigned short	R	
43615	U_Unterbrechung_Dauer_N_9	Spannung Unterbrechung Dauer [ms] @ n-9	Unsigned short	R	
43616	U_Unterbrechung_Query_N_9	Spannung Unterbrechung Typ: 0: ND 1: U_L1N 2: U_L2N 3: U_L3N 4: U_L1L2 5: U_L2L3 6: U_L3L1	Unsigned short	R	
43617	U_Unterbrechung_Wert_EEPROM	Spannung Unterbrechung RMS-Wert (zwischen 10% und 90% "Nenn-sternspannung") EEPROM Daten	Float	R	
43619	U_Unterbrechung_Jahr_EEPROM	Spannung Unterbrechung Jahr EEPROM Daten	Unsigned short	R	
43620	U_Unterbrechung_Monat_EEPROM	Spannung Unterbrechung Monat EEPROM Daten	Unsigned short	R	
43621	U_Unterbrechung_Tag_EEPROM	Spannung Unterbrechung Tag EEPROM Daten	Unsigned short	R	
43622	U_Unterbrechung_Stunden_EEPROM	Spannung Unterbrechung Stunden EEPROM Daten	Unsigned short	R	
43623	U_Unterbrechung_Minuten_EEPROM	Spannung Unterbrechung Minuten EEPROM Daten	Unsigned short	R	
43624	U_Unterbrechung_Sekunden_EEPROM	Spannung Unterbrechung Sekunden EEPROM Daten	Unsigned short	R	
43625	U_Unterbrechung_Dauer_EEPROM	Spannung Unterbrechung Dauer [ms] EEPROM Daten	Unsigned short	R	
43626	U_Unterbrechung_Query_EEPROM	Spannung Unterbrechung Typ: 0: ND 1: U_L1N 2: U_L2N 3: U_L3N 4: U_L1L2 5: U_L2L3 6: U_L3L1	Unsigned short	R	
43627 bis 43881	U_L1N_Oscilloscope_0...127	Sternspannung L1-N Sample #0 ... #127	Float	R	
43883 bis 44137	U_L2N_Oscilloscope_0...127	Sternspannung L2-N Sample #0 ... #127	Float	R	
44139 bis 44393	U_L3N_Oscilloscope_0...127	Sternspannung L3-N Sample #0 ... #127	Float	R	
44395 bis 44649	U_L12_Oscilloscope_0...127	Nennspannung L1-L2 Sample #0 ... #127	Float	R	
44651 bis 44905	U_L23_Oscilloscope_0...127	Nennspannung L2-L3 Sample #0 ... #127	Float	R	

44907 bis 45161	U_L31_Oscilloscope_ 0...127	Nennspannung L3-L1 Sample #0 ... #127	Float	R	
45163 bis 45417	I_L1_Oscilloscope_ 0...127	Strom L1 Sample #0 ... #127	Float	R	
45419 bis 45673	I_L2_Oscilloscope_ 0...127	Strom L2 Sample #0 ... #127	Float	R	
45675 bis 45929	I_L3_Oscilloscope_ 0...127	Strom L3 Sample #0 ... #127	Float	R	
45931 bis 46185	I_N_Oscilloscope_ 0...127	Strom N Sample #0 ... #127	Float	R	

8. Kennzeichnung der Typenschilder

SIRAX MT7100

Article-No.: 180034
20161118105725
HW: 04 FW: 001 M. ID: 25





SIRAX MT7150

Article-No.: 180042
20161118105725
HW: 04 FW: 001 M. ID: 25

Camille Bauer Metrawatt AG

Aargauerstrasse 7
5610 Wohlen / Switzerland

9. Zeichenerklärung

Symbol	Bedeutung
	Geräte dürfen nur fachgerecht entsorgt werden!
	CE-Konformitätszeichen. Das Gerät erfüllt die Bedingungen der zutreffenden EG-Richtlinien. Siehe Konformitätserklärung.
	Achtung! Allgemeine Gefahrenstelle. Betriebsanleitung beachten.
	Achtung: Lebensgefahr!
	Bitte beachten

10. Dimensionen

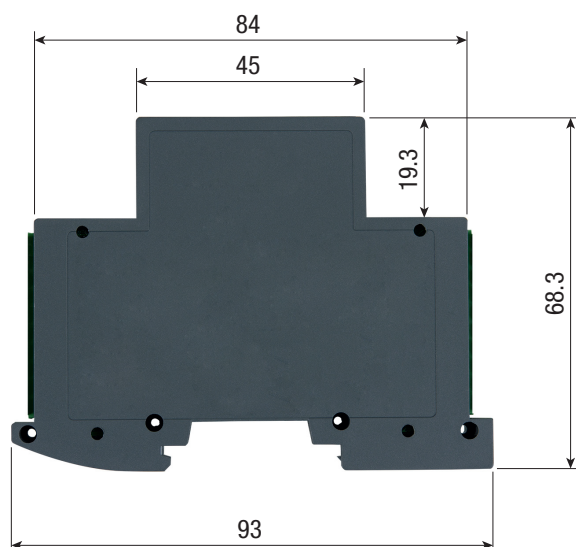

SIRAX MT7100 / MT7150

Table of Contents

1. Legal information	32
1.1 Safety and warning notices	32
1.2 Qualified personnel	32
1.3 Intended use	33
1.4 Disclaimer of liability	33
1.5 Feedback	33
1.6 Repair work and modifications	33
1.7 Calibration and new adjustment	33
1.8 Disposal	33
1.9 Return	33
2. Introduction	33
2.1 Purpose of this document	33
2.2 Scope of supply	33
2.3 Further documents	33
3. Functional description	34
4. Assembly and installation	34
5. Electrical connections	34
6. Technical specifications	35
7. Programming	39
7.1 Programming over Software	39
7.1.1 Configuration	39
7.2 Programming over Modbus Address-Register	43
8. Identification of the type label	60
9. Sign explanation	60
10. Dimensions drawings	60

1. Legal information

1.1 Safety and warning notices

In this document safety and warning notices are used, which you have to observe to ensure personal safety and to prevent damage to property.



If the warning notice is not followed death or severe personal injury **will** result.



If the warning notice is not followed damage to property or severe personal injury **may** result.



If the warning notice is not followed the device **may** be damaged or **may** not fulfill the expected functionality.



The installation and commissioning should only be carried out by trained personnel.

Check the following points before commissioning:

- that the maximum values for all the connections are not exceeded, see „Technical data“ section,
- that the connection wires are not damaged, and that they are not live during wiring,
- that the power flow direction and the phase rotation are correct.

The instrument must be taken out of service if safe operation is no longer possible (e.g. visible damage). In this case, all the connections must be switched off. The instrument must be returned to the factory or to an authorized service dealer.

It is forbidden to open the housing and to make modifications to the instrument. The instrument is not equipped with an integrated circuit breaker. During installation check that a labeled switch is installed and that it can easily be reached by the operators.

Unauthorized repair or alteration of the unit invalidates the warranty.



Please observe that the data on the type plate must be adhered to!

The national provisions have to be observed in the installation and material selection of electric lines!

1.2 Qualified personnel

The product described in this document may be handled by personnel only, which is qualified for the respective task. Qualified personnel have the training and experience to identify risks and potential hazards when working with the product. Qualified personnel are also able to understand and follow the given safety and warning notices.

1.3 Intended use

The product described in this document may be used only for the application specified. The maximum electrical supply data and ambient conditions specified in the technical data section must be adhered. For the perfect and safe operation of the device proper transport and storage as well as professional assembly, installation, handling and maintenance are required.

1.4 Disclaimer of liability

The content of this document has been reviewed to ensure correctness. Nevertheless it may contain errors or inconsistencies and we cannot guarantee completeness and correctness. This is especially true for different language versions of this document. This document is regularly reviewed and updated. Necessary corrections will be included in subsequent version and are available via our webpage www.camillebauer.com.

1.5 Feedback

If you detect errors in this document or if there is necessary information missing, please inform us via e-mail to: customer-support@camillebauer.com

1.6 Repair work and modifications

Repair work and modifications shall exclusively be carried out by the manufacturer. Do not open the housing of the device. In case of any tampering with the device, the warranty claim shall lapse. We reserve the right of changing the product to improve it.

1.7 Calibration and new adjustment

Each device is adjusted and checked before delivery. The condition as supplied to the customer is measured and stored in electronic form. The uncertainty of measurement devices may be altered during normal operation if, for example, the specified ambient conditions are not met.

1.8 Disposal



Device may only be disposed in a professional manner!

The disposal of devices and components may only be realised in accordance with good professional practice observing the country-specific regulations. Incorrect disposal can cause environmental risks.

1.9 Return

All devices delivered to Camille Bauer Metrawatt AG shall be free of any hazardous contaminants (acids, lyes, solutions, etc.). Use original packaging or suitable transport packaging to return the device.



Damage by returning

Damages caused by improper returning, no warranties or guarantees can be given.

2. Introduction

2.1 Purpose of this document

This document describes the three phase meter SIRAX MT7100 and MT7150. It is intended to be used by Installation personnel, commissioning engineers, Service and maintenance personnel.

Scope

This handbook is valid for all versions of the three phase meter SIRAX MT7100 and MT7150. Some of the functions described in this document are available only, if the necessary optional components are included in the device.

Required knowledge

A general knowledge in the field of electrical engineering is required. For assembly and installation of the device knowledge of applicable national safety regulations and installation standard is required.

2.2 Scope of supply

- three phase meter SIRAX MT7100 or MT7150 with connection set
- Safety instructions (ge, en, fr, it, es, nl, cz)

2.3 Further documents

The following documents are provided electronically via www.camillebauer.com:

- Datasheet (ge, en)
- Safety instructions (ge, en, fr, it, es, nl, cz)
- Operating manual (ge, en)

3. Functional description

The SIRAX MT7100 and MT7150 are all-in-one three phase meter with integrated energy meter and universal current input. They are designed for DIN rail mounting installation and can be connected to Common current and voltage transformers and Rogowski coils. The devices measure RMS AC and DC, average min. and max. values, frequency, crest factor, harmonic up to the 63rd, THD, I_{peak} and U_{peak} and many more. They are equipped with a serial output RS485 Modbus RTU for measurements and a digital output for alarms. The free configuration software makes it very easy to configure the devices.

4. Assembly and installation



Ensure a safe working environment during assembly, installation and maintenance work. Disconnect the power supply of the primary conductor and secure it against unintentional reconnection.

Magnetic fields of high intensity can vary the values measured by the transformer. Avoid installation near permanent magnets, electromagnets or iron masses that induce strong changes in the magnetic field. If there are any irregularities, we recommend realigning or moving the transformer in the most appropriate area.

- Mounting is done by DIN rail mounting and the installation of the devices is arbitrary.
- Now connect the device according to the wiring diagram.

5. Electrical connections



Attention: danger to life! Ensure under all circumstances that the leads are free of potential when connecting them!



It is to be noted, that the data given on the type plate are respected!

The national regulations for the installation and selection of the material of the electrical cables must be followed!

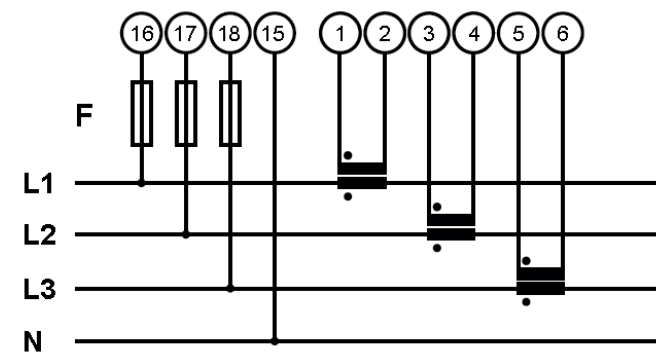

3-phase, 3 wires, 3 CT's connection

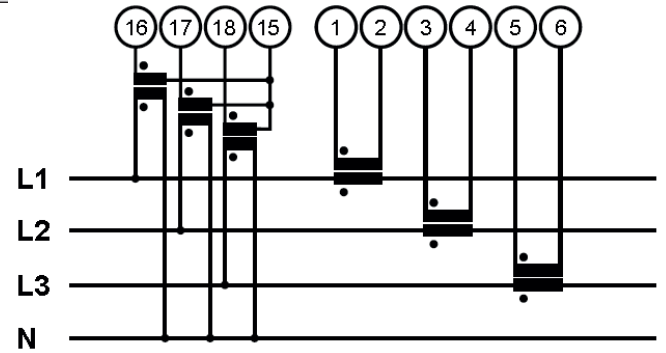

3-phase, 3 wires, 3 CT's and 3VT's connection

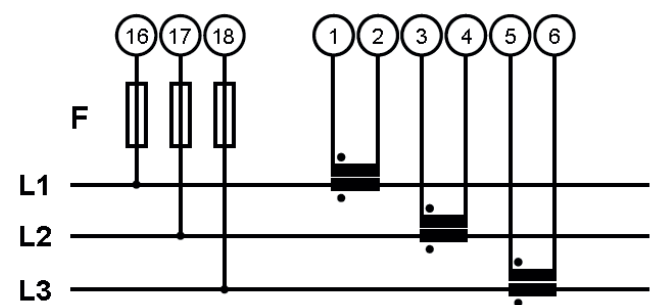

3-phase, 3 wires, 2 CT's connection (Aron)

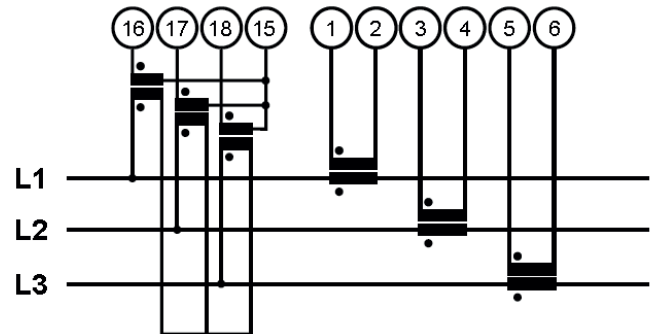

3-phase, 3 wires, 2 CT's and 3VT's connection (Aron)

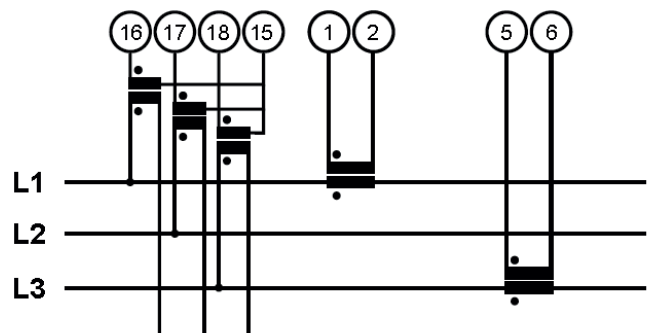
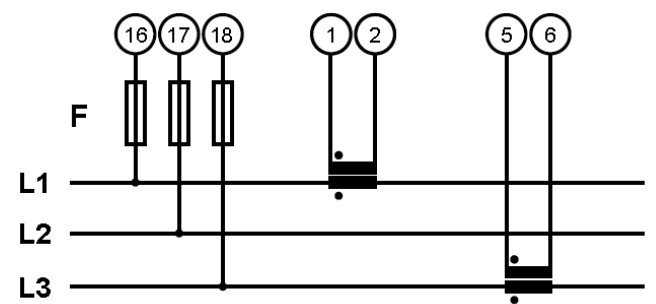

1-phase, 2 wires, connection with 1 TA

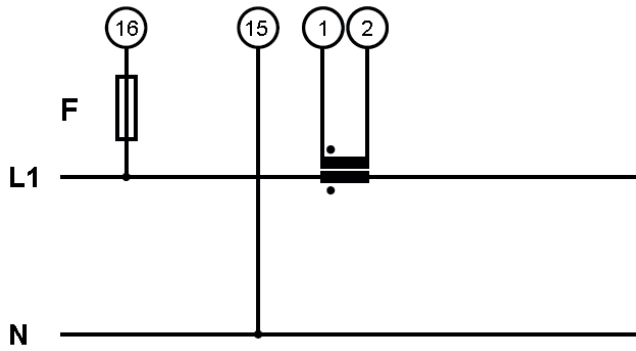

Digital Output on terminal 8-9-10 in digital output configuration

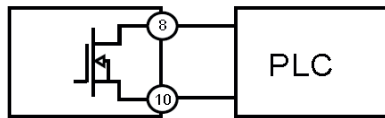

Communication via T-BUS (with the proper optional connector)

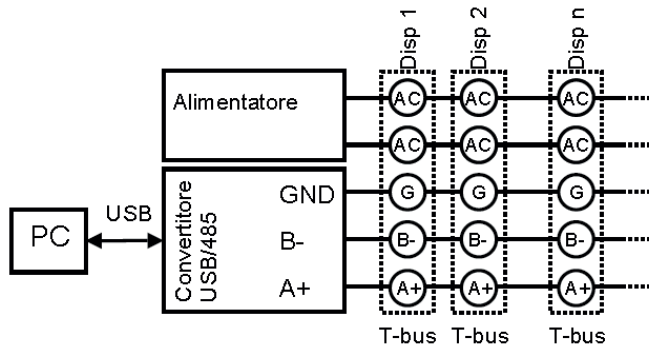

1-phase, 2 wires, connection with 1 TA and 1TV

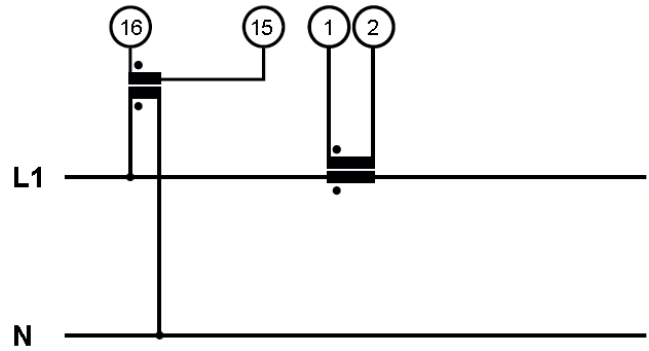

Power supply

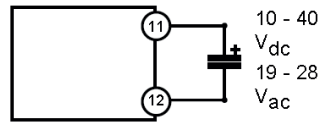

Communication via terminal 8-9-10 in RS485 configuration

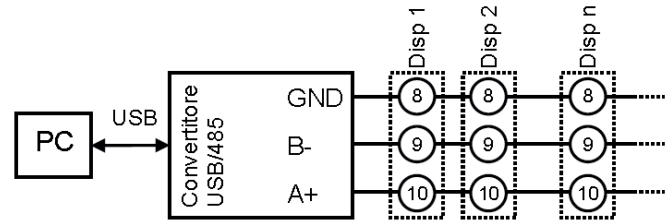

6. Technical specifications

	SIRAX MT7100	SIRAX MT7150
Input		
Current sensors	Rogowski probe; Current transformer secondary 1A / 5A; Voltage transformer 0 ... 333 mV	
Available measure	I_{rms} ; U_{rms} ; I_{pk} ; U_{pk} per phase; Active power: P_1, P_2, P_3 ; Reactive power: Q_1, Q_2, Q_3 ; Apparent power: S_1, S_2, S_3 ; Frequency; Power factor total and per phase; Energy (kWh) total and per phase; bidirectional Energy (kWh) total and positive/negative per phase; $\cos\phi$; Active and reactive energy (kVARh) total and per phase; Crest factor total and per phase $\tan\phi$ per phase and average; Power factor total, per phase and average; Power factor distortion per phase and average; power measurement min/max total, per phase and average; monitoring phase sequence; max demand over 15 min. total and per phase; time at which arises max demand (per month) total and per phase; time above a threshold total and per phase; K factor; THD; TDD; harmonics analysis up to 63 th ; interharmonics analysis up to 63 th ; SAG; SWELL; Voltage interruption;	
Voltage input		
Nominal voltage U_n	$300 V_{LN} / 500 V_{LL}$	
Impedance	400 k Ω	

Continuous overload U_{max}	400 V_{LN} / 700 V_{LL}
Overload for 500 ms	600 V_{LN} / 1000 V_{LL}
Current input	
Type	not isolated (external CTs necessary)
Current output CT's	
Nominal current I_n	5 AAC
Impedance	< 0.5 VA per phase
Continuous overload I_{max}	6 AAC
Overload for 500 ms	40 AAC
Crest factor	< 4 (20 A_{PK} max.)
Voltage output CT's	
Nominal voltage U_n	333 mVAC
Impedance	220 k Ω
Continuous overload U_{max}	2.1 V_{PK}
Overload for 500 ms	13 V_{PK}
Crest factor	< 3 (1 V_{PK} max.)
Working frequency	1 ... 70 Hz
Power supply	10 ... 30 VDC or 19 ... 28 VAC
Power consumption	< 0.7 W
Output	
Digital output	RS485 (Modbus RTU)
Baudrate	from 1200 ... 115200 (standard 9600)
Accuracy (@ 25 \pm 5 $^{\circ}$ C, Frequency = 50 Hz)	
Voltage (U_n : 230/400V)	\pm 0.5% RDG (10 ... 100% U_n)
Current (I_n : 5A)	\pm 0.5% RDG (5 ... 100% I_n)
Frequency	\pm 0.1 Hz (40 ... 70 Hz)
Active and reactive power	\pm 0.5% RDG
Active energy	Class C according to EN50470-1/3 or Class 0.5S according to EN62053-22
Reactive energy	Class 0.5S according to EN62053-24
Power factor	\pm (0.001 +1%(1.00-PF))
Bandwidth (-3dB)	> 2 kHz
Temperature coefficient	< 100 ppm/ $^{\circ}$ C
Absorption	< 500 mW @ 24 VDC
Sampling rate	6400 Hz @ 50 Hz or 7280 Hz @ 60 Hz
Energy backup	Via Flash, minimum lifetime: 3 years
Environmental conditions	
Operating temperature	-10 ... +60 $^{\circ}$ C
Storage temperature	-40 ... +85 $^{\circ}$ C
Humidity	10 ... 90 % (not condensing)
Altitude	max. 2000 m
Safety	
Overvoltage category	CATIII
Isolation	4 kV_{RMS} between power supply and measuring inputs 4 kV_{RMS} between RS485 and measuring inputs 1.5 kV_{RMS} between power supply and RS485

Housing protection IP	IP20
Mechanical properties	
housing material	PTB
Flammability	UL94 V-0, self-extinguishing, non-dripping, halogen-free
Weight	60 g
DIP Switch	2 Pol
Dimensions	93 x 17.7 x 68.3 mm (without connectors)
Connections	
Connections	Plug-in terminals 3.5 mm, 1 x 2 pole, 1 x 3 pole, 1 x 6 pole Plug-in terminals 5.08 mm, 1 x 4 pole
Cross-sectional area	1.5 mm ²
Torque	max. 0.25 Nm
Standards	
Adhered standards	EN61000-6-2 ; EN61000-6-4; EN61000-4-2; EN61000-4-3; EN61000-4-4; EN61000-4-5; EN61000-4-6; EN61010-1; EN61010-2-30

Designation LED

Function	State	Note	
Power (green)	Stedy on	Powered device	
Fail (yellow)	Blinking	Bootloader active: Can be executed through Modbus command, or because of program flash corruption.	
	Stedy on	At least one of the following state is present:	
		EEPROM fail	Error on storing flash for settings, calibration or energies
		Phase reversal	Phase sequence L_1, L_2, L_3 is not correct
		I_i or U_i over-range	Current or voltage phase i has a too high positive value
I_i or U_i under-range	Current or voltage phase i has a too high negative value		
RX (red)	Blinking	The device is receiving data from RS485	
TX (red)	Blinking	The device is sending data from RS485	
D_{out} (green)	Stedy on	Digital output is closed	

Digital output alarms

Rising: Normally open contact

Falling: Normally closed contact

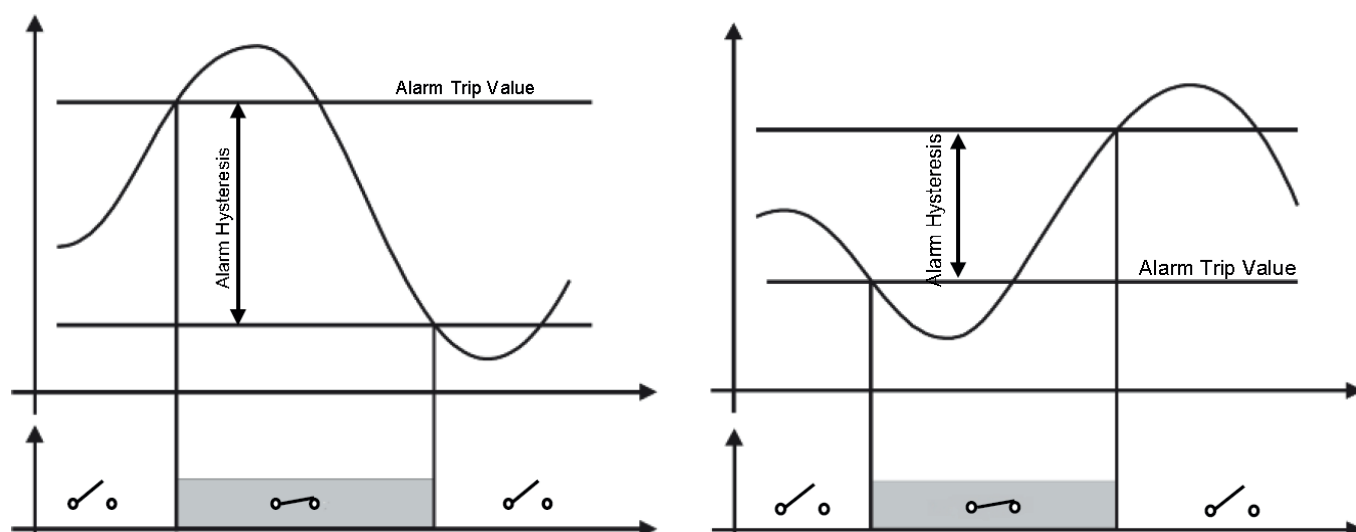

Windowed: closed contact between threshold

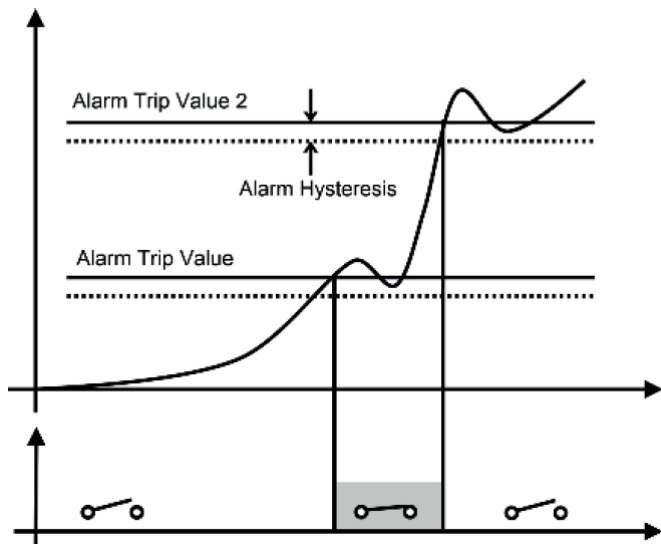

Windowed: closed contact outside threshold

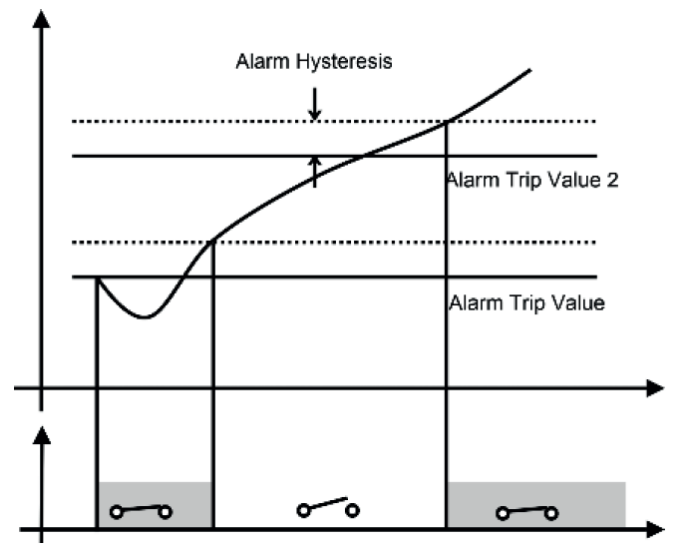

Note: To enable digital output alarms, RS485 terminals must be configured for digital output. Communication will be available only on T-BUS.

Accuracy (according to EN50470-3 and EN62053-24)

Wh, accuracy depending on the load (current output CT)

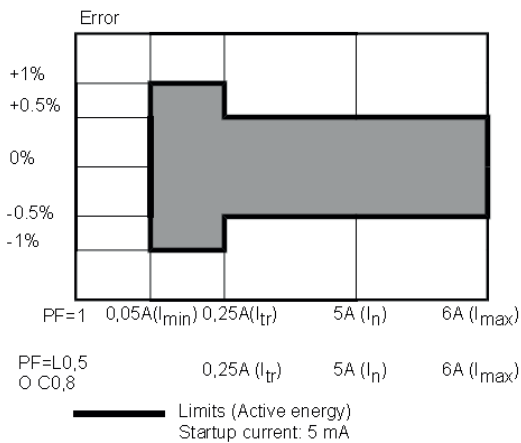

VARh, accuracy depending on the load (current output CT)

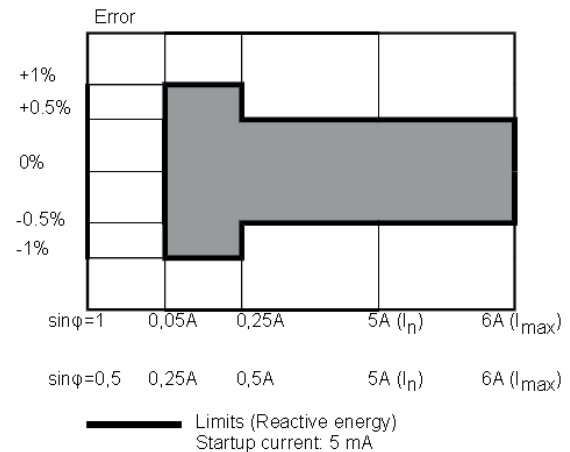

Wh, accuracy depending on the load (voltage output CT)

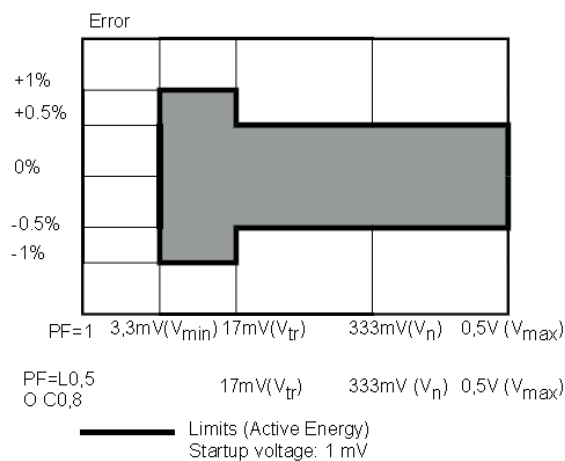

VARh, accuracy depending on the load (voltage output CT)

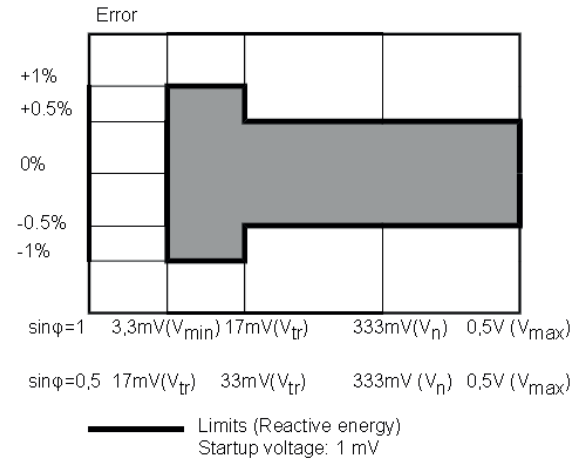

Note: Reactive power accuracy is granted if the instrument Q calculation is according Budeanu formula.

Used calculation formulas

Phase variables

Voltage RMS

$$V_i = \sqrt{\frac{1}{N} * \sum_1^N (v_{Li})^2}$$

Current RMS

$$I_i = \sqrt{\frac{1}{N} * \sum_1^N (i_{Li})^2}$$

Active power

$$P_i = \frac{1}{N} * \sum_1^N v_{Li} * i_{Li}$$

Apparent power

$$S_i = V_i * I_i$$

Reactive power

$$Q_i = \frac{1}{N} * \sum_1^N v_{Li} * \hat{i}_{Li} \quad \text{Budeanu}$$

$$Q_i = \sqrt{S_i^2 - P_i^2} \quad \text{triangular}$$

Power factor

$$\cos \phi_i = \frac{P_i}{S_i}$$

System variables

Voltage average

$$V_{AVG} = \frac{V_1 + V_2 + V_3}{3}$$

Current average

$$I_{AVG} = \frac{I_1 + I_2 + I_3}{3}$$

Three phase active power

$$P_{3PH} = P_1 + P_2 + P_3$$

Three phase apparent power

$$S_{3PH} = S_1 + S_2 + S_3$$

Three phase reactive power

$$Q_{3PH} = Q_1 + Q_2 + Q_3$$

Three phase power factor

$$\cos \phi_{3PH} = \frac{P_{3PH}}{S_{3PH}}$$

Energy metering

Active energy

$$Wh_i = \int_{t_1}^{t_2} P_i(t) dt \approx \Delta t \sum_{n_1}^{n_2} P(n)_i$$

Reactive energy

$$VARh_i = \int_{t_1}^{t_2} Q_i(t) dt \approx \Delta t \sum_{n_1}^{n_2} Q(n)_i$$

Apparent energy

$$VAh_i = \int_{t_1}^{t_2} S_i(t) dt \approx \Delta t \sum_{n_1}^{n_2} S(n)_i$$

Where:

i = phase observed (L1; L2 or L3);

P = Active power;

Q = Reactive power;

t1, t2 = starting and ending time points of consumption recording;

n = time unit;

t = time unit length;

n1, n2 = starting and ending discrete time points of consumption recording

7. Programming

The SIRAX MT7100 and MT7150 can be programmed in two ways. On the one hand via the serial RS485-USB interface and the programming software and on the other hand over the direct use of the Modbus address registers.

If you want to set up the units via the programming software, set the DIP switches to 0. If you want to set directly via the RS485 Modbus interface, set the first DIP switch to 1 (up) and then the second one for the baud rate setting 0 for 9600 or 1 for 38400. After making the settings, save the configuration via the command register, then turn off the power before setting the DIP switches to 0 to turn on the power.



Any changes made by dip-switch required to switch off the power supply. It's a safety condition in order to prevent any manumission on the device.

Description	1	2
RS485 settings from EEPROM	0	X
Address 1 - Baudrate 9600, no parity	1	0
Address 1 - Baudrate 38400, no parity	1	1

7.1 Programming over Software

Download the programming software for free from our homepage www.camillebauer.com. Before you can use the software, check if you have Java (32-bit) installed on your computer. If not, download the Java software from the homepage www.java.com.

To change the menu language of the software, go to the downloaded directory of the software. Open the file "015.ini" and "current" with a text editor program. Now change the listed language, e.g. "EN" in the desired language e.g. "DE". Please note that only the languages listed in the directory can be changed.

7.1.1 Configuration



Start the software with the file SIRAX MT71xx_023_v003.jar

Now click on "NEXT" to get into the menu window Connection.

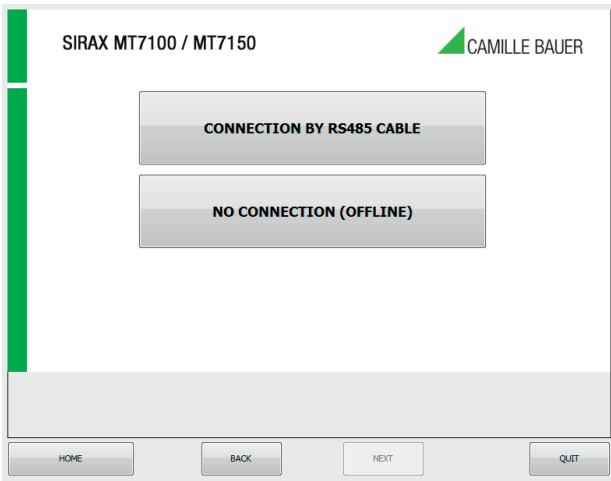

In this mode, you can choose to program the device via a direct connection via RS485-USB, or in offline mode.

Select the mode "Connection with RS485 connection", then you get to the menu "DIP switch setting"

If you select the mode "no connection (OFF-Line)", then you arrive DIRECTLY to the menu "configuration".

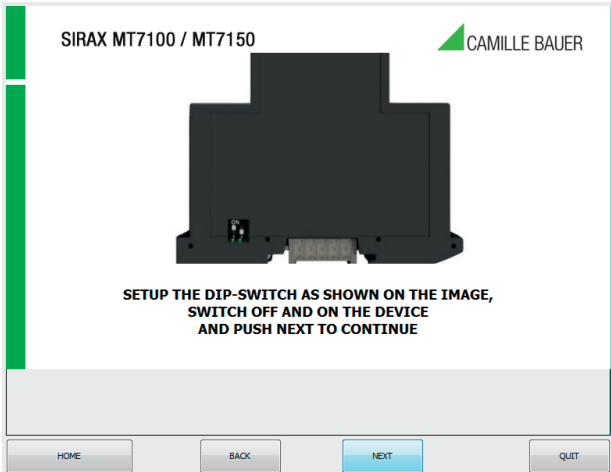

Set the DIP switches according to the template. Detailed information on the individual positions of the DIP switches can be found in the table "DIP switch settings" on page 45.

Press "Next".

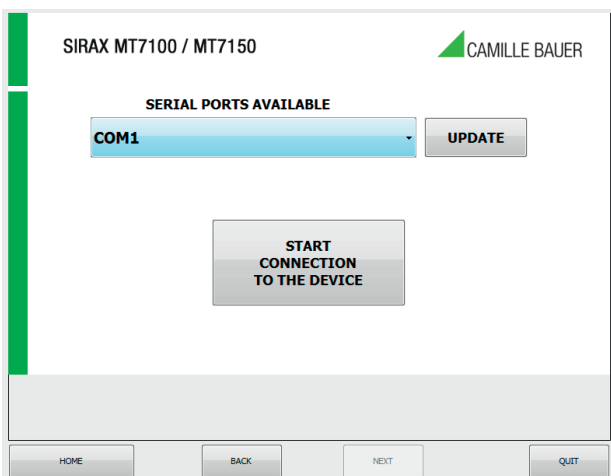

To communicate with the SIRAX MT7000 or MT7050, check the available COM PORT by clicking on the "UPDATE" button. Your PC will assign a virtual COM for communication with the SIRAX MT7100 or MT7150.

Click the "CONNECT TO THE DEVICE" button, you will see a window asking if you are connected to the device. Then click on this button in this window "CONTINUE". After you have established the connection, you can proceed with the configuration of the device on the setting pages described below.

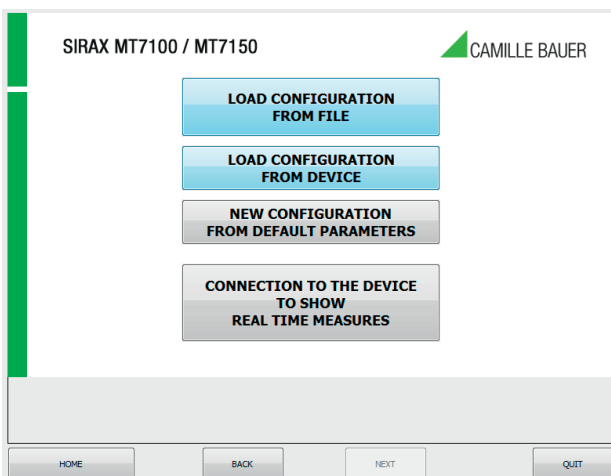

Now select the type of configuration creation.

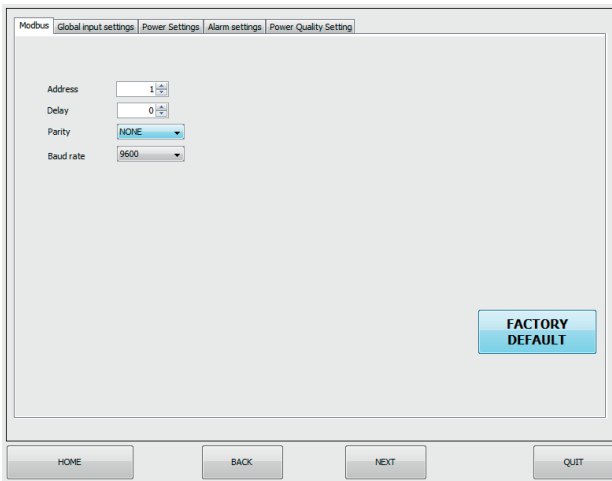

This is the device configuration page where the parameters for Modbus communication are set:

1. The Modbus "ADDRESS" to be assigned to the device
2. The "delay" to answer
3. The speed communication "BAUDRATE" (from 1200 to 115200)
4. The parity is always None

To use the default settings, click on the "FACTORY SETTINGS" button

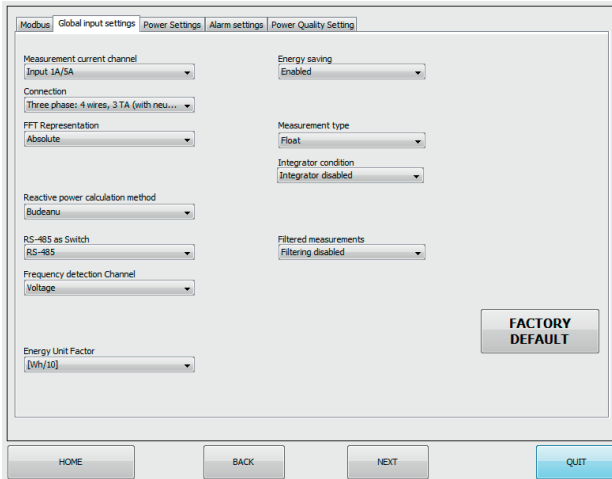

This is the device configuration page where the general input settings are set. The following parameters can be set:

- Measurement current channel
- Connection
- Reactive power calculation method
- Frequency detection channel
- Energy unit factor
- Energy saving on/off
- Measurement type
- Integrator condition
- Filtered measurements

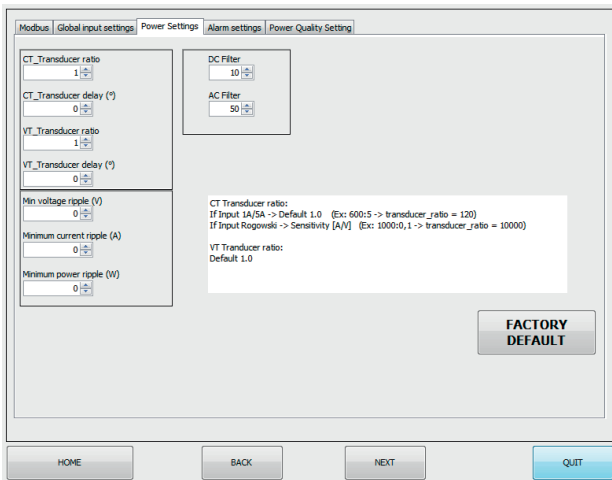

This is the device configuration page where the power settings are made. The following parameters can be set:

- Transformer ratios
- Min. Ripple voltage, current and power
- AC or DC filter

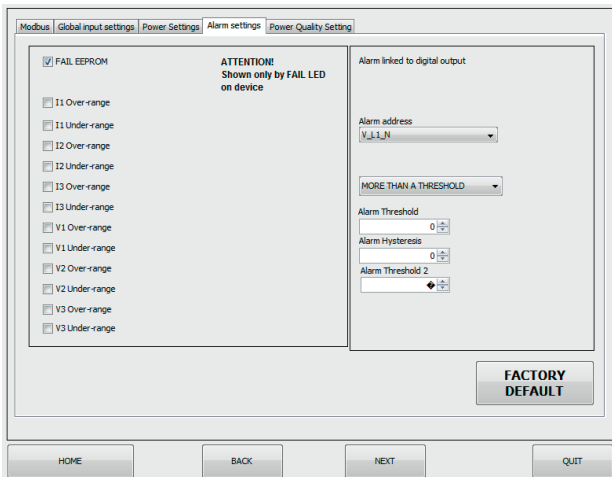

This is the device configuration page where the alarm settings are set. There are two types of selectable alarms, one with LED and the other with contact (switch).

LED ALARM

Check for the presence of anomalies, the user can select to enable of FAIL LED by checking one or more of the following flag

SWITCH ALARM

Selecting the desired parameter in the dropdown menu, you set the threshold and hysteresis value to activate the alarm on digital output.

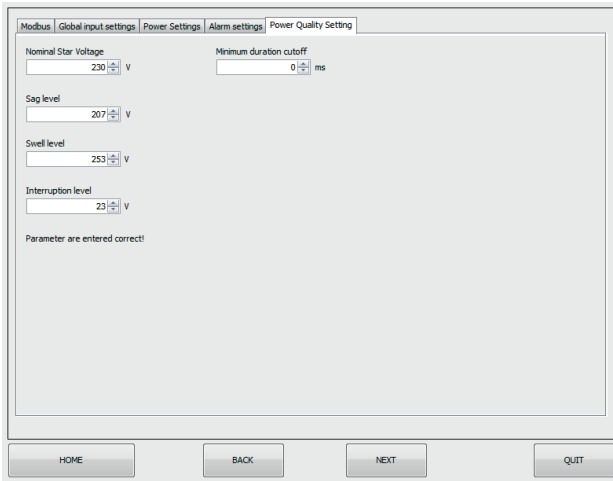

This is the device configuration page where the power quality settings are made. The following parameters can be set:

- Nominal star voltage
- SAG and SWELL Level
- Interruption level
- Minimum duration cutoff

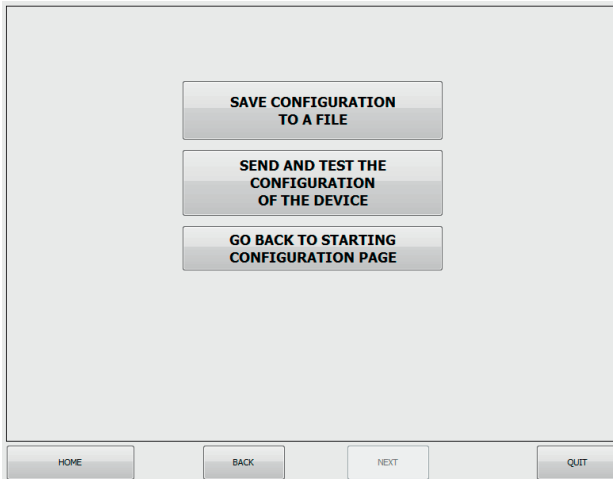

Now select whether you want to save the configuration in a file or transfer it to the device.

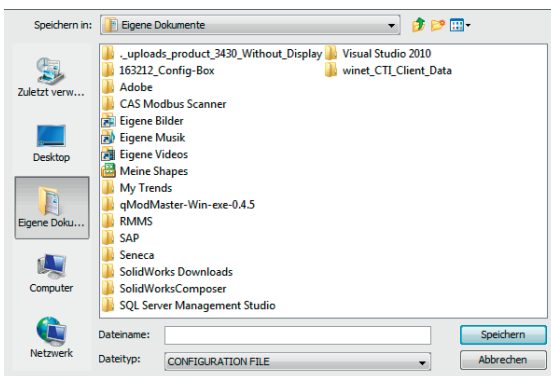

This screen allows you to save the configuration in to a file.

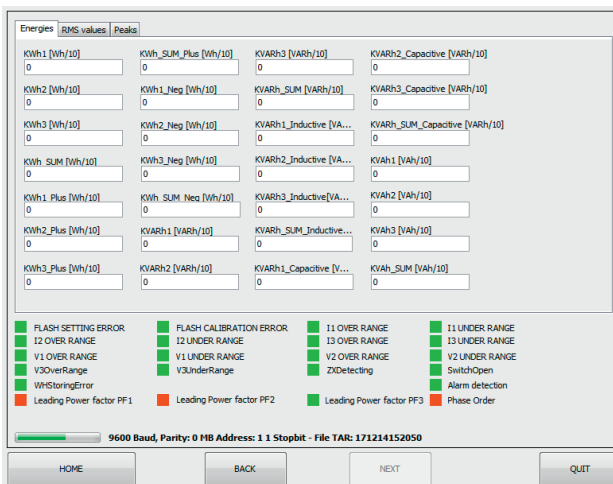

This screen allows you to check the functionality of the device. The energies, RMS values and peaks can be displayed.

7.2 Programmierung über Modbus Adress-Register

Modbus Adresse	Register Name	Parameter Beschreibung	Register-Typ	Lesen / Schreiben	Standard Werte
40001	Machine_Id	Maschine ID	Unsigned short	R	23 or 32
40002	HW_FW_version	Hardware (MSB) and Firmware (LSB) Revision	Unsigned short	R	
40003	Address	Modbus Address	Unsigned short	R/W	1
40004	Delay	Answer delay expressed as cycles	Unsigned short	R/W	1
40005	Baudrate	Baudrate: 0=1200 / 1=2400 / 2=4800 / 3=9600 / 4=19200 / 5=38400 / 6=57600 / 7=115200	Unsigned short	R/W	3
40006	Parity	0=NONE / 1=ODD / 2=EVEN	Unsigned short	R/W	0
40007	Configuration_Flag	<p>Bit 0: Current Measurement type 0=Input 1A/5A 1=Input 333mV / Rogowski</p> <p>Bit 1...2: Connection 0=Single phase 1=Three phase: 3 wires, 2 CT (Aron) 2=Three phase: 3 wires, 3 CT 3=Three phase: 4 wires, 3 CT (with neutral)</p> <p>Bit 3: FFT representation 0=Absolute 1=Relative to the I1 value</p> <p>Bit 5: Reactive power calculation method 0=Triangle method 1=Budeanu</p> <p>Bit 6: RS485 as Switch 0=RS485 1=Switch</p> <p>Bit 7: Frequency detection Channel 0=Voltage 1=Current</p> <p>Bit 8: Voltage input type 0=Normal load 1=PWM modulated input (Inverter Load)</p> <p>Bit 9: Energy saving 0=Disabled 1=Enabled</p> <p>Bit 11...12: Measurement type 0=Float 1=Float Swapped 2=Hundredth (Float * 100) 3=Hundredth swapped (Float * 100 SW)</p> <p>Bit 13: Integrator condition 0=Integrator disabled 1=Integrator enabled (Rogowski input)</p> <p>Bit 10, 14: Output switch initial condition 0=Closed initial condition 1=Windowed: closed contact between thresholds 2=Open initial condition 3=Windowed: closed contact outside thresholds</p> <p>Bit 15: Filtered measurement 0=Filtering disabled 1=Filtering enabled</p>	Unsigned short	R/W	16934 INPUT_1A_5A I THREE_PHASE_4W_3CT I FFT_REPRESENTATION_ABSOLUTE I BUDEANU I RS485_BEHAVIOUR I FREQUENCY_DETECTION_ON_VOLTAGE I NORMAL_INPUT_ENERGY_SAVING_ENABLED I FLOAT_TYPE_INTEGRATOR_DISABLED I OPEN_COND I FILTERED_OUTPUT_DISABLED
40008	Led_settings	<p>Set the error LED according to the bit:</p> <p>0=Fail Eeprom (settings, calibration or Energy) 1=Phase reversal 2=I1 Over-range 3=I1 Under-range 4=I2 Over-range 5=I2 Under-range 6=I3 Over-range 7=I3 Under-range 8=V1 Over-range 9=V1 Under-range 10=V2 Over-range 11=V2 Under-range 12=V3 Over-range 13=V3 Under-range</p>	Unsigned short	R/W	1: Fail EEPROM

40009	CT_Transducer_ratio	If Input 1A/5A → Current transformer ratio M/N (Ex: 600:5 → transducer_ratio = 120) If Input Rogowski / 333mV → (1 / Sensitivity) [A/V] (Ex: 100mV/1KA → transducer_ratio = 10000, 333mV/5A → transducer_ratio = 15)	Float	R/W	1
40011	CT_Transducer_delay	Current transformer delay in [°] @ 50 Hz for accurate power calculation	Float	R/W	0
40013	VT_Transducer_ratio	Voltage transformer ratio M/N - Default 1.0 (Ex: 1000:100 → transducer_ratio = 10)	Float	R/W	1
40015	VT_Transducer_delay	Voltage transformer delay in [°] @ 50 Hz for accurate power calculation	Float	R/W	0
40017	minimum_voltage_ripple	Minimum threshold under which the instrument reads 0 independent from the input value	Float	R/W	0
40019	minimum_current_ripple	Minimum threshold under which the instrument reads 0 independent from the input value	Float	R/W	0
40021	minimum_power_ripple	Minimum threshold under which the instrument reads 0 independent from the input value (P, Q, and S)	Float	R/W	0
40023	DC_Filter	Number of tenth seconds for I RMS value in DC	Unsigned short	R/W	10
40024	AC_Filter	Number of zero crossings for I RMS value in AC	Unsigned short	R/W	50
40025	Minute_for_Max_demand	Minute for Max demand calculation (0..45)	Unsigned short	R/W	15
40027	Seconds_for_mean_RMS	Register in seconds (0...30) for RMS average	Unsigned short	R/W	0
40028	Seconds_for_MAX_RMS	Seconds 1...30 for MAX RMS value. If the register is 0, then the absolute MAX RMS is given	Unsigned short	R/W	0
40029	Seconds_for_min_RMS	Seconds 1...30 for min RMS value. If the register is 0, then the absolute min RMS is given	Unsigned short	R/W	0
40030	Energy_unit_factor	Variable for changing Energy measurement unit: 0=WH/10 1=Wh 4=kWh	Unsigned short	R/W	0
40036	Alarm_Register_Start_Address	Float value Starting address for alarm (40361 V_L1_N, 40363 V_L2_N, 40365 V_L3_N, ecc)	Unsigned short	R/W	40361
40037	Alarm_trip_value	Alarm Threshold for "closed" and "open" condition OR first alarm Threshold for "within threshold" and "Outside"	Float	R/W	0
40039	Alarm_hysteresis	Alarm Hysteresis	Float	R/W	1
40041	Alarm_trip_value_2	Second alarm Threshold for "within threshold" and "Outside threshold" condition	Float	R/W	
40043	Power_Threshold_for_exceed	Threshold for Power exceedings monitoring	Float	R/W	0
40045	Nominal_Star_Voltage	Nominal Star Voltage for Sag, Swell, Interruption monitoring [V]	Float	R/W	230
40047	Sag_percentage_level	Percentage over Nominal_Star_Voltage under which a Sag event is generated (default 0.9 = 90 %); must be over Interruption	Float	R/W	0.9
40049	Swell_percentage_level	Percentage over Nominal_Star_Voltage over which a Swell event is generated (default 1.1 = 110 %)	Float	R/W	1.1
40051	Interruption_percentage_level	Percentage over Nominal_Star_Voltage under which an Interruption event is generated (default 0.1 = 10 %)	Float	R/W	0.1
40053	Minimum_duration_cutoff	Sag, Swell or Interruption events must be above this cutoff to be displayed and saved [ms]	Unsigned short	R/W	0
40239	Status_1	bit 0: flash settings error bit 1: flash calibration error bit 2: Current I1 Over Range bit 3: Current I1 Under Range bit 4: Current I2 Over Range bit 5: Current I2 Under Range bit 6: Current I3 Over Range bit 7: Current I3 Under Range bit 8: Current V1 Over Range bit 9: Current V1 Under Range bit 10: Current V2 Over Range bit 11: Current V2 Under Range bit 12: Current V3 Over Range bit 13: Current V3 Under Range	Unsigned long	R	

		bit 14: Zero crossing detecting bit 15: Switch open bit 16: Wh storing error bit 17...18: don't care bit 19: Alarm detection bit 20...27: don't care bit 28: Leading Power factor PF1 bit 29: Leading Power factor PF2 bit 30: Leading Power factor PF3			
40244	Command	Flash settings save command = 0xC1C0 Reset command = 0xC1A0 Save energy command = 0xBABA Close Switch command = 0xDAAA (only if Digital Output is enabled) Open Switch command = 0xDAAB (only if Digital Output is enabled) Enter Bootloader command = 0xB000Reset MAX Demand registers command = 0xF000	Unsigned short	R/W	
40245	kWh 1	Active energy line 1 [Wh tenth]	Signed long long	R/W	
10249	kWh 2	Active energy line 2 [Wh tenth]	Signed long long	R/W	
40253	kWh 3	Active energy line 3 [Wh tenth]	Signed long long	R/W	
40257	kWh_SUM	Active energy three phase [Wh tenth]	Signed long long	R/W	
40261	kWh1_Plus	Positive Active energy line 1 [Wh tenth]	Signed long long	R/W	
40265	kWh2_Plus	Positive Active energy line 2 [Wh tenth]	Signed long long	R/W	
40269	kWh3_Plus	Positive Active energy line 3 [Wh tenth]	Signed long long	R/W	
40273	kWh_SUM_Plus	Positive Active energy three phase [Wh tenth]	Signed long long	R/W	
40277	kWh1_Neg	Negative Active energy line 1 [Wh tenth]	Signed long long	R/W	
40281	kWh2_Neg	Negative Active energy line 2 [Wh tenth]	Signed long long	R/W	
40285	kWh3_Neg	Negative Active energy line 3 [Wh tenth]	Signed long long	R/W	
40289	kWh_SUM_Neg	Negative Active energy three phase [Wh tenth]	Signed long long	R/W	
40293	kVARh 1	Reactive energy line 1 [VARh tenth]	Signed long long	R/W	
40297	kVARh 2	Reactive energy line 2 [VARh tenth]	Signed long long	R/W	
40301	kVARh 3	Reactive energy line 3 [VARh tenth]	Signed long long	R/W	
40305	kVARh_SUM	Reactive energy three phase [VARh tenth]	Signed long long	R/W	
40309	kVARh1_Inductive	Inductive Reactive energy line 1 [VARh tenth]	Signed long long	R/W	
40313	kVARh2_Inductive	Inductive Reactive energy line 2 [VARh tenth]	Signed long long	R/W	
40317	kVARh3_Inductive	Inductive Reactive energy line 3 [VARh tenth]	Signed long long	R/W	
40321	kVARh_SUM_Inductive	Inductive Reactive energy three phase [VARh tenth]	Signed long long	R/W	
40325	kVARh1_Capacitive	Capacitive Reactive energy line 1 [VARh tenth]	Signed long long	R/W	
40329	kVARh2_Capacitive	Capacitive Reactive energy line 2 [VARh tenth]	Signed long long	R/W	
40333	kVARh3_Capacitive	Capacitive Reactive energy line 3 [VARh tenth]	Signed long long	R/W	
40337	kVARh_SUM_Capacitive	Capacitive Reactive energy three phase [VARh tenth]	Signed long long	R/W	
40341	kVAh 1	Apparent energy line 1 [VAh tenth]	Signed long long	R/W	
40345	kVAh 2	Apparent energy line 2 [VAh tenth]	Signed long long	R/W	
40349	kVAh 3	Apparent energy line 3 [VAh tenth]	Signed long long	R/W	
40353	kVAh_SUM	Apparent energy three phase [VAh tenth]	Signed long long	R/W	
40357	Wh_storage_count	Number of Wh flash savings (every 20 seconds)	Unsigned long	R	
40359	V_L1_N	RMS star voltage L1-N [V]	Float	R	
40361	V_L2_N	RMS star voltage L2-N [V]	Float	R	
40363	V_L3_N	RMS star voltage L3-N [V]	Float	R	
40365	V_STAR_AVERAGE	RMS star avg value voltage [V]	Float	R	
40367	V_L1_L2	RMS line voltage L1-L2 [V]	Float	R	
40369	V_L2_L3	RMS line voltage L2-L3 [V]	Float	R	
40371	V_L3_L1	RMS line voltage L3-L1 [V]	Float	R	
40373	V_LINE_AVERAGE	RMS line average value voltage [V]	Float	R	
40375	I_L1	RMS line current L1 [A]	Float	R	
40377	I_L2	RMS line current L2 [A]	Float	R	
40379	I_L3	RMS line current L3 [A]	Float	R	
40381	I_N	RMS line current N [A] (if 1 or 2 TA connection, I_N=0)	Float	R	
40383	I_AVERAGE	RMS average value current [A] (excluding neutral current I_N)	Float	R	
40385	P1	RMS active power line 1 [W]	Float	R	
40387	P2	RMS active power line 2 [W]	Float	R	
40389	P3	RMS active power line 3 [W]	Float	R	

40391	P_SUM	RMS sum active power [W]	Float	R	
40393	Q1	RMS reactive power line 1 [VAR]	Float	R	
40395	Q2	RMS reactive power line 2 [VAR]	Float	R	
40397	Q3	RMS reactive power line 3 [VAR]	Float	R	
40399	Q_SUM	RMS sum reactive power [VAR]	Float	R	
40401	S1	RMS apparent power line 1 [VA]	Float	R	
40403	S2	RMS apparent power line 2 [VA]	Float	R	
40405	S3	RMS apparent power line 3 [VA]	Float	R	
40407	S_SUM	RMS sum apparent power [VA]	Float	R	
40409	PF1	Power Factor line 1	Float	R	
40411	PF2	Power Factor line 2	Float	R	
40413	PF3	Power Factor line 3	Float	R	
40415	PF_3PH	Three Phase Power Factor	Float	R	
40417	CF1	Crest Factor line 1	Float	R	
40419	CF2	Crest Factor line 2	Float	R	
40421	CF3	Crest Factor line 3	Float	R	
40423	CF_N	Crest Factor Neutral	Float	R	
40425	Frequenz	Frequency [Hz]	Float	R	
40427	V_L1_N_peak	Star voltage L1-N peak [V]	Float	R/W	
40429	V_L2_N_peak	Star voltage L2-N peak [V]	Float	R/W	
40431	V_L3_N_peak	Star voltage L3-N peak [V]	Float	R/W	
40433	V_L1_L2_peak	Line voltage L1-L2 peak [V]	Float	R/W	
40435	V_L2_L3_peak	Line voltage L2-L3 peak [V]	Float	R/W	
40437	V_L3_L1_peak	Line voltage L3-L1 peak [V]	Float	R/W	
40439	I_L1_peak	L1 current peak [A]	Float	R/W	
40441	I_L2_peak	L2 current peak [A]	Float	R/W	
40443	I_L3_peak	L3 current peak [A]	Float	R/W	
40445	I_N_peak	N current peak [A]	Float	R/W	
40467	DPF1	Distortion Power Factor line 1 (+ inductive, - capacitive)	Float	R	
40469	DPF2	Distortion Power Factor line 2 (+ inductive, - capacitive)	Float	R	
40471	DPF3	Distortion Power Factor line 3 (+ inductive, - capacitive)	Float	R	
40473	DPF_N	Neutral Distortion Power Factor (+ inductive, - capacitive)	Float	R	
40475	TAN_FL_1	Tanφ L1 (+ inductive, - capacitive)	Float	R	
40477	TAN_FL_2	Tanφ L2 (+ inductive, - capacitive)	Float	R	
40479	TAN_FL_3	Tanφ L3 (+ inductive, - capacitive)	Float	R	
40481	TAN_FL_AVERAGE	Average Tanφ (+ inductive, - capacitive)	Float	R	
40483	Phase_Order	L1, L2, L3 = 0 / L1, L3, L2 = 1	Float	R	
40485	Internal_temperature	Internal Temperature [°C]	Float	R	
40487	V_L1_N_RMS_AVG	Star voltage L1_N RMS average [V] over "seconds_for_mean_RMS"	Float	R	
40489	V_L1_N_RMS_Max	Star voltage L1_N MAX RMS [V] over last "seconds_for_MAX_RMS"	Float	R	
40491	V_L1_N_RMS_Min	Star voltage L1_N Min RMS [V] over last"seconds_for_min_RMS"	Float	R	
40493	V_L2_N_RMS_AVG	Star voltage L2_N RMS average [V] over "seconds_for_mean_RMS"	Float	R	
40495	V_L2_N_RMS_Max	Star voltage L2_N MAX RMS [V] over last "seconds_for_MAX_RMS"	Float	R	
40497	V_L2_N_RMS_Min	Star voltage L2_N Min RMS [V] over last"seconds_for_min_RMS"	Float	R	
40499	V_L3_N_RMS_AVG	Star voltage L3_N RMS average [V] over "seconds_for_mean_RMS"	Float	R	
40501	V_L3_N_RMS_Max	Star voltage L3_N MAX RMS [V] over last "seconds_for_MAX_RMS"	Float	R	
40503	V_L3_N_RMS_Min	Star voltage L3_N Min RMS [V] over last"seconds_for_min_RMS"	Float	R	
40505	V_Star_AVG_RMS_AVG	Star voltage AVG RMS average [V] over "seconds_for_mean_RMS"	Float	R	
40507	V_Star_AVG_RMS_Max.	Star voltage AVG MAX RMS [V] over last "seconds_for_MAX_RMS"	Float	R	
40509	V_Star_AVG_RMS_Min.	Star voltage AVG Min RMS [V] over last"seconds_for_min_RMS"	Float	R	

40511	V_L1_L2_RMS_AVG	Line voltage L1-Line voltage L2-Line voltage L3-L1 RMS average [V] over "seconds_for_mean_RMS"	Float	R	
40513	V_L1_L2_RMS_Max.	Line voltage L1-Line voltage L2-Line voltage L3-L1 MAX RMS [V] over last "seconds_for_MAX_RMS"	Float	R	
40515	V_L1_L2_RMS_Min.	Line voltage L1-Line voltage L2-Line voltage L3-L1 Min RMS [V] over last"seconds_for_min_RMS"	Float	R	
40517	V_L2_L3_RMS_AVG	Line voltage L2-Line voltage L3-L1 RMS average [V] over "seconds_for_mean_RMS"	Float	R	
40519	V_L2_L3_RMS_Max.	Line voltage L2-Line voltage L3-L1 MAX RMS [V] over last "seconds_for_MAX_RMS"	Float	R	
40521	V_L2_L3_RMS_Min.	Line voltage L2-Line voltage L3-L1 Min RMS [V] over last"seconds_for_min_RMS"	Float	R	
40523	V_L3_L1_RMS_AVG	Line voltage L3-L1 RMS average [V] over "seconds_for_mean_RMS"	Float	R	
40525	V_L3_L1_RMS_Max.	Line voltage L3-L1 MAX RMS [V] over last "seconds_for_MAX_RMS"	Float	R	
40527	V_L3_L1_RMS_Min.	Line voltage L3-L1 Min RMS [V] over last"seconds_for_min_RMS"	Float	R	
40529	V_Line_AVG_RMS_AVG	Line voltage AVG RMS average [V] over "seconds_for_mean_RMS"	Float	R	
40531	V_Line_AVG_RMS_Max.	Line voltage AVG MAX RMS [V] over last "seconds_for_MAX_RMS"	Float	R	
40533	V_Line_AVG_RMS_Min.	Line voltage AVG Min RMS [V] over last"seconds_for_min_RMS"	Float	R	
40535	I_L1_RMS_AVG	L1 RMS average [A] over "seconds_for_mean_RMS"	Float	R	
40537	I_L1_RMS_Max.	L1 MAX RMS [A] over last "seconds_for_MAX_RMS"	Float	R	
40539	I_L1_AVG_Min.	L1 Min RMS [A] over last"seconds_for_min_RMS"	Float	R	
40541	I_L2_RMS_AVG	L2 RMS average [A] over "seconds_for_mean_RMS"	Float	R	
40543	I_L2_RMS_Max.	L2 MAX RMS [A] over last "seconds_for_MAX_RMS"	Float	R	
40545	I_L2_AVG_Min.	L2 Min RMS [A] over last"seconds_for_min_RMS"	Float	R	
40547	I_L3_RMS_AVG	L3 RMS average [A] over "seconds_for_mean_RMS"	Float	R	
40549	I_L3_RMS_Max.	L3 MAX RMS [A] over last "seconds_for_MAX_RMS"	Float	R	
40551	I_L3_AVG_Min.	L3 Min RMS [A] over last"seconds_for_min_RMS"	Float	R	
40553	I_N_RMS_AVG	N RMS average [A] over "seconds_for_mean_RMS"	Float	R	
40555	I_N_RMS_Max.	N MAX RMS [A] over last "seconds_for_MAX_RMS"	Float	R	
40557	I_N_AVG_Min.	N Min RMS [A] over last"seconds_for_min_RMS"	Float	R	
40559	I_AVG_RMS_AVG	I_AVG RMS average [A] over "seconds_for_mean_RMS"	Float	R	
40561	I_AVG_RMS_Max.	I_AVG MAX RMS [A] over last "seconds_for_MAX_RMS"	Float	R	
40563	I_AVG_RMS_Min.	I_AVG Min RMS [A] over last"seconds_for_min_RMS"	Float	R	
40565	P1_RMS_AVG	P1 RMS average [A] over "seconds_for_mean_RMS"	Float	R	
40567	P1_RMS_Max.	P1 MAX RMS [A] over last "seconds_for_MAX_RMS"	Float	R	
40569	P1_RMS_Min.	P1 Min RMS [A] over last"seconds_for_min_RMS"	Float	R	
40571	P2_RMS_AVG	P2 RMS average [A] over "seconds_for_mean_RMS"	Float	R	
40573	P2_RMS_Max.	P2 MAX RMS [A] over last "seconds_for_MAX_RMS"	Float	R	
40575	P2_RMS_Min.	P2 Min RMS [A] over last"seconds_for_min_RMS"	Float	R	
40577	P3_RMS_AVG	P3 RMS average [A] over "seconds_for_mean_RMS"	Float	R	
40579	P3_RMS_Max.	P3 MAX RMS [A] over last "seconds_for_MAX_RMS"	Float	R	
40581	P3_RMS_Min.	P3 Min RMS [A] over last"seconds_for_min_RMS"	Float	R	
40583	P-SUM_RMS_AVG	P_SUM RMS average [A] over "seconds_for_mean_RMS"	Float	R	
40585	P_SUM_RMS_Max.	P_SUM MAX RMS [A] over last "seconds_for_MAX_RMS"	Float	R	
40587	P_SUM_RMS_Min.	P_SUM Min RMS [A] over last"seconds_for_min_RMS"	Float	R	
40589	Q1_RMS_AVG	Q1 RMS average [A] over "seconds_for_mean_RMS"	Float	R	
40591	Q1_RMS_Max.	Q1 MAX RMS [A] over last "seconds_for_MAX_RMS"	Float	R	
40593	Q1_RMS_Min.	Q1 Min RMS [A] over last"seconds_for_min_RMS"	Float	R	
40595	Q2_RMS_AVG	Q2 RMS average [A] over "seconds_for_mean_RMS"	Float	R	
40597	Q2_RMS_Max.	Q2 MAX RMS [A] over last "seconds_for_MAX_RMS"	Float	R	
40599	Q2_RMS_Min.	Q2 Min RMS [A] over last"seconds_for_min_RMS"	Float	R	
40601	Q3_RMS_AVG	Q3 RMS average [A] over "seconds_for_mean_RMS"	Float	R	
40603	Q3_RMS_Max.	Q3 MAX RMS [A] over last "seconds_for_MAX_RMS"	Float	R	
40605	Q3_RMS_Min.	Q3 Min RMS [A] over last"seconds_for_min_RMS"	Float	R	
40607	Q-SUM_RMS_AVG	Q_SUM RMS average [A] over "seconds_for_mean_RMS"	Float	R	
40609	Q_SUM_RMS_Max.	Q_SUM MAX RMS [A] over last "seconds_for_MAX_RMS"	Float	R	
40611	Q_SUM_RMS_Min.	Q_SUM Min RMS [A] over last"seconds_for_min_RMS"	Float	R	

40613	S1_RMS_AVG	S1 RMS average [A] over "seconds_for_mean_RMS"	Float	R	
40615	S1_RMS_Max.	S1 MAX RMS [A] over last "seconds_for_MAX_RMS"	Float	R	
40617	S1_RMS_Min.	S1 Min RMS [A] over last"seconds_for_min_RMS"	Float	R	
40619	S2_RMS_AVG	S2 RMS average [A] over "seconds_for_mean_RMS"	Float	R	
40621	S2_RMS_Max.	S2 MAX RMS [A] over last "seconds_for_MAX_RMS"	Float	R	
40623	S2_RMS_Min.	S2 Min RMS [A] over last"seconds_for_min_RMS"	Float	R	
40625	S3_RMS_AVG	S3 RMS average [A] over "seconds_for_mean_RMS"	Float	R	
40627	S3_RMS_Max.	S3 MAX RMS [A] over last "seconds_for_MAX_RMS"	Float	R	
40629	S3_RMS_Min.	S3 Min RMS [A] over last"seconds_for_min_RMS"	Float	R	
40631	S-SUM_RMS_AVG	S_SUM RMS average [A] over "seconds_for_mean_RMS"	Float	R	
40633	S_SUM_RMS_Max.	S_SUM MAX RMS [A] over last "seconds_for_MAX_RMS"	Float	R	
40635	S_SUM_RMS_Min.	S_SUM Min RMS [A] over last"seconds_for_min_RMS"	Float	R	
40637	PF1_RMS_AVG	PF1 RMS average [A] over "seconds_for_mean_RMS"	Float	R	
40639	PF1_RMS_Max.	PF1 MAX RMS [A] over last "seconds_for_MAX_RMS"	Float	R	
40641	PF1_RMS_Min.	PF1 Min RMS [A] over last"seconds_for_min_RMS"	Float	R	
40643	PF2_RMS_AVG	PF2 RMS average [A] over "seconds_for_mean_RMS"	Float	R	
40645	PF2_RMS_Max.	PF2 MAX RMS [A] over last "seconds_for_MAX_RMS"	Float	R	
40647	PF2_RMS_Min.	PF2 Min RMS [A] over last"seconds_for_min_RMS"	Float	R	
40649	PF3_RMS_AVG	PF3 RMS average [A] over "seconds_for_mean_RMS"	Float	R	
40651	PF3_RMS_Max.	PF3 MAX RMS [A] over last "seconds_for_MAX_RMS"	Float	R	
40653	PF3_RMS_Min.	PF3 Min RMS [A] over last"seconds_for_min_RMS"	Float	R	
40655	PF_SUM_RMS_AVG	PF_SUM RMS average [A] over "seconds_for_mean_RMS"	Float	R	
40657	PF_SUM_RMS_Max.	PF_SUM MAX RMS [A] over last "seconds_for_MAX_RMS"	Float	R	
40659	PF_SUM_RMS_Min.	PF_SUM Min RMS [A] over last"seconds_for_min_RMS"	Float	R	
40661	P1_Time_over_threshold	Time above threshold specified in "Power_Threshold_for_exceedings" for Active Power P1 [min]	Float	R	
40663	P2_Time_over_threshold	Time above threshold specified in "Power_Threshold_for_exceedings" for Active Power P2 [min]	Float	R	
40665	P3_Time_over_threshold	Time above threshold specified in "Power_Threshold_for_exceedings" for Active Power P3 [min]	Float	R	
40667	P_SUM_Time_over_threshold	Time above threshold specified in "Power_Threshold_for_exceedings" for Active Power P_SUM [min]	Float	R	
40669	P1_MaxDemand	Max Demand over 15minutes for P1 for current month	Float	R	
40671	P2_MaxDemand	Max Demand over 15minutes for P2 for current month	Float	R	
40673	P3_MaxDemand	Max Demand over 15minutes for P3 for current month	Float	R	
40675	P_SUM_MaxDemand	Max Demand over 15minutes for P three phase for current month	Float	R	
40677	Time_of_P1_MaxDemand	Time at which arises Max Demand over 15minutes for P1 for current month (month, day, hour, minutes)	Unsigned long	R	
40679	Time_of_P2_MaxDemand	Time at which arises Max Demand over 15minutes for P2 for current month (month, day, hour, minutes)	Unsigned long	R	
40681	Time_of_P3_MaxDemand	Time at which arises Max Demand over 15minutes for P3 for current month (month, day, hour, minutes)	Unsigned long	R	
40683	Time_of_P_SUM_Max-Demand	Time at which arises Max Demand over 15minutes for P three phase for current month (month, day, hour, minutes)	Unsigned long	R	
40685	K_Factor_I1	K-factor for I1, see IEEE Standard 1100-1992	Float	R	
40687	K_Factor_I2	K-factor for I2, see IEEE Standard 1100-1992	Float	R	
40689	K_Factor_I3	K-factor for I3, see IEEE Standard 1100-1992	Float	R	
40691	Year	RTC: Year (2000...2099)	Unsigned short	R/W	
40692	Month	RTC: Month (1...12)	Unsigned short	R/W	
40693	Day	RTC: Day (1...31)	Unsigned short	R/W	
40694	Hour	RTC: Hour (0...23)	Unsigned short	R/W	
40695	Minute	RTC: Minute (0...59)	Unsigned short	R/W	
40696	Seconds	RTC: Seconds (0...59)	Unsigned short	R/W	
40697	THD_V_L1	THD Star Voltage L1	Float	R	
40699	THD_V_L2	THD Star Voltage L2	Float	R	
40701	THD_V_L3	THD Star Voltage L3	Float	R	
40703	THD_V_L12	THD Line Voltage L1-L2	Float	R	
40705	THD_V_L23	THD Line Voltage L2-L3	Float	R	
40707	THD_V_L31	THD Line Voltage L3-L1	Float	R	
40709	THD_I_L1	THD Line Current L1	Float	R	
40711	THD_I_L2	THD Line Current L2	Float	R	
40713	THD_I_L3	THD Line Current L3	Float	R	

40715	THD_I_N	THD Neutral Current	Float	R	
40717	TDD_I_L1	TDD Line Current L1	Float	R	
40719	TDD_I_L2	TDD Line Current L2	Float	R	
40721	TDD_I_L3	TDD Line Current L3	Float	R	
40737 up to 40863	V_L1N_H_0...63	Star Voltage L1-N Harmonic 0 up to 63	Float	R	
40865 up to 40991	V_L2N_H_0...63	Star Voltage L2-N Harmonic 0 up to 63	Float	R	
40993 up to 41119	V_L3N_H_0...63	Star Voltage L3-N Harmonic 0 up to 63	Float	R	
41121 up to 41247	V_L12_H_0...63	Line Voltage L1-L2 Harmonic 0 up to 63	Float	R	
41249 up to 41375	V_L23_H_0...63	Line Voltage L2_L3 Harmonic 0 up to 63	Float	R	
41377 up to 41503	V_L31_H_0...63	Line Voltage L3-L1 Harmonic 0 up to 63	Float	R	
41507 up to 41631	I_L1_H_0...63	Line Current L1 Harmonic 0 up to 63	Float	R	
41633 up to 41759	I_L2_H_0...63	Line Current L2 Harmonic 0 up to 63	Float	R	
41761 up to 41887	I_L3_H_0...63	Line Current L3 Harmonic 0 up to 63	Float	R	
41889 up to 42015	I_N_H_0...63	Line Current N Harmonic 0 up to 63	Float	R	
42017 up to 42143	V_L1N_IH_0...63	Star Voltage L1-N InterHarmonic 0 up to 63	Float	R	
42145 up to 42271	V_L2N_IH_0...63	Star Voltage L2-N InterHarmonic 0 up to 63	Float	R	
42273 up to 42399	V_L3N_IH_0...63	Star Voltage L3-N InterHarmonic 0 up to 63	Float	R	
42401 up to 42527	V_L12_IH_0...63	Line Voltage L1-L2 InterHarmonic 0 up to 63	Float	R	
42529 up to 42655	V_L23_IH_0...63	Line Voltage L2-L3 InterHarmonic 0 up to 63	Float	R	
42657 up to 42783	V_L31_IH_0...63	Line Voltage L3-L1 InterHarmonic 0 up to 63	Float	R	
42785 up to 42911	I_L1_IH_0...63	Line Current L1 InterHarmonic 0 up to 63	Float	R	
42913 up to 43039	I_L2_IH_0...63	Line Current L2 InterHarmonic 0 up to 63	Float	R	
43041 up to 43167	I_L3_IH_0...63	Line Current L3 InterHarmonic 0 up to 63	Float	R	
43169 up to 43295	I_N_IH_0...63	Line Current N InterHarmonic 0 up to 63	Float	R	
43297	V_SAG_VALUE_N_0	Voltage Sag RMS Value (between 10% and 90% "Nominal_Star_Voltage") @ n-0	Float	R	
43299	V_SAG_YEAR_N_0	Voltage Sag Year @ n-0	Unsigned short	R	
43300	V_SAG_MONTH_N_0	Voltage Sag Month @ n-0	Unsigned short	R	
43301	V_SAG_DAY_N_0	Voltage Sag Day @ n-0	Unsigned short	R	
43302	V_SAG_HOUR_N_0	Voltage Sag Hour @ n-0	Unsigned short	R	
43303	V_SAG_MINUTE_N_0	Voltage Sag Minute @ n-0	Unsigned short	R	
43304	V_SAG_SECOND_N_0	Voltage Sag Second @ n-0	Unsigned short	R	
43305	V_SAG_DURATION_N_0	Voltage Sag Duration [ms] @ n-0	Unsigned short	R	
43306	V_SAG_QUERY_N_0	Voltage Sag Type: 0: ND 1: V_L1N 2: V_L2N 3: V_L3N 4: V_L1L2 5: V_L2L3 6: V_L3L1	Unsigned short	R	
43307	V_SAG_VALUE_N_1	Voltage Sag RMS Value (between 10% and 90% "Nominal_Star_Voltage") @ n-1	Float	R	
43309	V_SAG_YEAR_N_1	Voltage Sag Year @ n-1	Unsigned short	R	
43310	V_SAG_MONTH_N_1	Voltage Sag Month @ n-1	Unsigned short	R	

43311	V_SAG_DAY_N_1	Voltage Sag Day @ n-1	Unsigned short	R	
43312	V_SAG_HOUR_N_1	Voltage Sag Hour @ n-1	Unsigned short	R	
43313	V_SAG_MINUTE_N_1	Voltage Sag Minute @ n-1	Unsigned short	R	
43314	V_SAG_SECOND_N_1	Voltage Sag Second @ n-1	Unsigned short	R	
43315	V_SAG_DURATION_N_1	Voltage Sag Duration [ms] @ n-1	Unsigned short	R	
43316	V_SAG_QUERY_N_1	Voltage Sag Type: 0: ND 1: V_L1N 2: V_L2N 3: V_L3N 4: V_L1L2 5: V_L2L3 6: V_L3L1	Unsigned short	R	
43317	V_SAG_VALUE_N_2	Voltage Sag RMS Value (between 10% and 90% "Nominal_Star_Voltage") @ n-2	Float	R	
43319	V_SAG_YEAR_N_2	Voltage Sag Year @ n-2	Unsigned short	R	
43320	V_SAG_MONTH_N_2	Voltage Sag Month @ n-2	Unsigned short	R	
43321	V_SAG_DAY_N_2	Voltage Sag Day @ n-2	Unsigned short	R	
43322	V_SAG_HOUR_N_2	Voltage Sag Hour @ n-2	Unsigned short	R	
43323	V_SAG_MINUTE_N_2	Voltage Sag Minute @ n-2	Unsigned short	R	
43324	V_SAG_SECOND_N_2	Voltage Sag Second @ n-2	Unsigned short	R	
43325	V_SAG_DURATION_N_2	Voltage Sag Duration [ms] @ n-2	Unsigned short	R	
43326	V_SAG_QUERY_N_2	Voltage Sag Type: 0: ND 1: V_L1N 2: V_L2N 3: V_L3N 4: V_L1L2 5: V_L2L3 6: V_L3L1	Unsigned short	R	
43327	V_SAG_VALUE_N_3	Voltage Sag RMS Value (between 10% and 90% "Nominal_Star_Voltage") @ n-3	Float	R	
43329	V_SAG_YEAR_N_3	Voltage Sag Year @ n-3	Unsigned short	R	
43330	V_SAG_MONTH_N_3	Voltage Sag Month @ n-3	Unsigned short	R	
43331	V_SAG_DAY_N_3	Voltage Sag Day @ n-3	Unsigned short	R	
43332	V_SAG_HOUR_N_3	Voltage Sag Hour @ n-3	Unsigned short	R	
43333	V_SAG_MINUTE_N_3	Voltage Sag Minute @ n-3	Unsigned short	R	
43334	V_SAG_SECOND_N_3	Voltage Sag Second @ n-3	Unsigned short	R	
43335	V_SAG_DURATION_N_3	Voltage Sag Duration [ms] @ n-3	Unsigned short	R	
43336	V_SAG_QUERY_N_3	Voltage Sag Type: 0: ND 1: V_L1N 2: V_L2N 3: V_L3N 4: V_L1L2 5: V_L2L3 6: V_L3L1	Unsigned short	R	
43337	V_SAG_VALUE_N_4	Voltage Sag RMS Value (between 10% and 90% "Nominal_Star_Voltage") @ n-4	Float	R	
43339	V_SAG_YEAR_N_4	Voltage Sag Year @ n-4	Unsigned short	R	
43340	V_SAG_MONTH_N_4	Voltage Sag Month @ n-4	Unsigned short	R	
43341	V_SAG_DAY_N_4	Voltage Sag Day @ n-4	Unsigned short	R	
43342	V_SAG_HOUR_N_4	Voltage Sag Hour @ n-4	Unsigned short	R	
43343	V_SAG_MINUTE_N_4	Voltage Sag Minute @ n-4	Unsigned short	R	
43344	V_SAG_SECOND_N_4	Voltage Sag Second @ n-4	Unsigned short	R	
43345	V_SAG_DURATION_N_4	Voltage Sag Duration [ms] @ n-4	Unsigned short	R	
43346	V_SAG_QUERY_N_4	Voltage Sag Type: 0: ND 1: V_L1N 2: V_L2N 3: V_L3N 4: V_L1L2 5: V_L2L3 6: V_L3L1	Unsigned short	R	
43347	V_SAG_VALUE_N_5	Voltage Sag RMS Value (between 10% and 90% "Nominal_Star_Voltage") @ n-5	Float	R	

43349	V_SAG_YEAR_N_5	Voltage Sag Year @ n-5	Unsigned short	R	
43350	V_SAG_MONTH_N_5	Voltage Sag Month @ n-5	Unsigned short	R	
43351	V_SAG_DAY_N_5	Voltage Sag Day @ n-5	Unsigned short	R	
43352	V_SAG_HOUR_N_5	Voltage Sag Hour @ n-5	Unsigned short	R	
43353	V_SAG_MINUTE_N_5	Voltage Sag Minute @ n-5	Unsigned short	R	
43354	V_SAG_SECOND_N_5	Voltage Sag Second @ n-5	Unsigned short	R	
43355	V_SAG_DURATION_N_5	Voltage Sag Duration [ms] @ n-5	Unsigned short	R	
43356	V_SAG_QUERY_N_5	Voltage Sag Type: 0: ND 1: V_L1N 2: V_L2N 3: V_L3N 4: V_L1L2 5: V_L2L3 6: V_L3L1	Unsigned short	R	
43357	V_SAG_VALUE_N_6	Voltage Sag RMS Value (between 10% and 90% "Nominal_Star_Voltage") @ n-6	Float	R	
43359	V_SAG_YEAR_N_6	Voltage Sag Year @ n-6	Unsigned short	R	
43360	V_SAG_MONTH_N_6	Voltage Sag Month @ n-6	Unsigned short	R	
43361	V_SAG_DAY_N_6	Voltage Sag Day @ n-6	Unsigned short	R	
43362	V_SAG_HOUR_N_6	Voltage Sag Hour @ n-6	Unsigned short	R	
43363	V_SAG_MINUTE_N_6	Voltage Sag Minute @ n-6	Unsigned short	R	
43364	V_SAG_SECOND_N_6	Voltage Sag Second @ n-6	Unsigned short	R	
43365	V_SAG_DURATION_N_6	Voltage Sag Duration [ms] @ n-6	Unsigned short	R	
43366	V_SAG_QUERY_N_6	Voltage Sag Type: 0: ND 1: V_L1N 2: V_L2N 3: V_L3N 4: V_L1L2 5: V_L2L3 6: V_L3L1	Unsigned short	R	
43367	V_SAG_VALUE_N_7	Voltage Sag RMS Value (between 10% and 90% "Nominal_Star_Voltage") @ n-7	Float	R	
43369	V_SAG_YEAR_N_7	Voltage Sag Year @ n-7	Unsigned short	R	
43370	V_SAG_MONTH_N_7	Voltage Sag Month @ n-7	Unsigned short	R	
43371	V_SAG_DAY_N_7	Voltage Sag Day @ n-7	Unsigned short	R	
43372	V_SAG_HOUR_N_7	Voltage Sag Hour @ n-7	Unsigned short	R	
43373	V_SAG_MINUTE_N_7	Voltage Sag Minute @ n-7	Unsigned short	R	
43374	V_SAG_SECOND_N_7	Voltage Sag Second @ n-7	Unsigned short	R	
43375	V_SAG_DURATION_N_7	Voltage Sag Duration [ms] @ n-7	Unsigned short	R	
43376	V_SAG_QUERY_N_7	Voltage Sag Type: 0: ND 1: V_L1N 2: V_L2N 3: V_L3N 4: V_L1L2 5: V_L2L3 6: V_L3L1	Unsigned short	R	
43377	V_SAG_VALUE_N_8	Voltage Sag RMS Value (between 10% and 90% "Nominal_Star_Voltage") @ n-8	Float	R	
43379	V_SAG_YEAR_N_8	Voltage Sag Year @ n-8	Unsigned short	R	
43380	V_SAG_MONTH_N_8	Voltage Sag Month @ n-8	Unsigned short	R	
43381	V_SAG_DAY_N_8	Voltage Sag Day @ n-8	Unsigned short	R	
43382	V_SAG_HOUR_N_8	Voltage Sag Hour @ n-8	Unsigned short	R	
43383	V_SAG_MINUTE_N_8	Voltage Sag Minute @ n-8	Unsigned short	R	
43384	V_SAG_SECOND_N_8	Voltage Sag Second @ n-8	Unsigned short	R	
43385	V_SAG_DURATION_N_8	Voltage Sag Duration [ms] @ n-8	Unsigned short	R	
43386	V_SAG_QUERY_N_8	Voltage Sag Type: 0: ND 1: V_L1N 2: V_L2N 3: V_L3N 4: V_L1L2 5: V_L2L3 6: V_L3L1	Unsigned short	R	

43387	V_SAG_VALUE_N_9	Voltage Sag RMS Value (between 10% and 90% "Nominal_Star_Voltage") @ n-9	Float	R	
43389	V_SAG_YEAR_N_9	Voltage Sag Year @ n-9	Unsigned short	R	
43390	V_SAG_MONTH_N_9	Voltage Sag Month @ n-9	Unsigned short	R	
43391	V_SAG_DAY_N_9	Voltage Sag Day @ n-9	Unsigned short	R	
43392	V_SAG_HOUR_N_9	Voltage Sag Hour @ n-9	Unsigned short	R	
43393	V_SAG_MINUTE_N_9	Voltage Sag Minute @ n-9	Unsigned short	R	
43394	V_SAG_SECOND_N_9	Voltage Sag Second @ n-9	Unsigned short	R	
43395	V_SAG_DURATION_N_9	Voltage Sag Duration [ms] @ n-9	Unsigned short	R	
43396	V_SAG_QUERY_N_7	Voltage Sag Type: 0: ND 1: V_L1N 2: V_L2N 3: V_L3N 4: V_L1L2 5: V_L2L3 6: V_L3L1	Unsigned short	R	
43397	V_SAG_VALUE_EEPROM	Voltage Sag RMS Value (between 10% and 90% "Nominal_Star_Voltage") EEPROM Data	Float	R	
43399	V_SAG_YEAR_EEPROM	Voltage Sag Year EEPROM Data	Unsigned short	R	
43400	V_SAG_MONTH_EEPROM	Voltage Sag Month EEPROM Data	Unsigned short	R	
43401	V_SAG_DAY_EEPROM	Voltage Sag Day EEPROM Data	Unsigned short	R	
43402	V_SAG_HOUR_EEPROM	Voltage Sag Hour EEPROM Data	Unsigned short	R	
43403	V_SAG_MINUTE_EEPROM	Spannung SAG Minuten EEPROM Data	Unsigned short	R	
43404	V_SAG_SECOND_EEPROM	Voltage Sag Minute EEPROM Data	Unsigned short	R	
43405	V_SAG_DURATION_EEPROM	Voltage Sag Duration [ms] EEPROM Data	Unsigned short	R	
43406	V_SAG_QUERY_EEPROM	Voltage Sag Type: 0: ND 1: V_L1N 2: V_L2N 3: V_L3N 4: V_L1L2 5: V_L2L3 6: V_L3L1	Unsigned short	R	
43407	V_SWELL_VALUE_N_0	Voltage Swell RMS Value (between 10% and 90% "Nominal_Star_Voltage") @ n-0	Float	R	
43409	V_SWELL_YEAR_N_0	Voltage Swell Year @ n-0	Unsigned short	R	
43410	V_SWELL_MONTH_N_0	Voltage Swell Month @ n-0	Unsigned short	R	
43411	V_SWELL_DAY_N_0	Voltage Swell Day @ n-0	Unsigned short	R	
43412	V_SWELL_HOUR_N_0	Voltage Swell Hour @ n-0	Unsigned short	R	
43413	V_SWELL_MINUTE_N_0	Voltage Swell Minute @ n-0	Unsigned short	R	
43414	V_SWELL_SECOND_N_0	Voltage Swell Second @ n-0	Unsigned short	R	
43415	V_SWELL_DURATION_N_0	Voltage Swell Duration [ms] @ n-0	Unsigned short	R	
43416	V_SWELL_QUERY_N_0	Voltage Swell Type: 0: ND 1: V_L1N 2: V_L2N 3: V_L3N 4: V_L1L2 5: V_L2L3 6: V_L3L1	Unsigned short	R	
43417	V_SWELL_VALUE_N_1	Voltage Swell RMS Value (between 10% and 90% "Nominal_Star_Voltage") @ n-1	Float	R	
43419	V_SWELL_YEAR_N_1	Voltage Swell Year @ n-1	Unsigned short	R	
43420	V_SWELL_MONTH_N_1	Voltage Swell Month @ n-1	Unsigned short	R	
43421	V_SWELL_DAY_N_1	Voltage Swell Day @ n-1	Unsigned short	R	
43422	V_SWELL_HOUR_N_1	Voltage Swell Hour @ n-1	Unsigned short	R	
43423	V_SWELL_MINUTE_N_1	Voltage Swell Minute @ n-1	Unsigned short	R	
43424	V_SWELL_SECOND_N_1	Voltage Swell Second @ n-1	Unsigned short	R	

43425	V_SWELL_DURATION_N_1	Voltage Swell Duration [ms] @ n-1	Unsigned short	R	
43426	V_SWELL_QUERY_N_1	Voltage Swell Type: 0: ND 1: V_L1N 2: V_L2N 3: V_L3N 4: V_L1L2 5: V_L2L3 6: V_L3L1	Unsigned short	R	
43427	V_SWELL_VALUE_N_2	Voltage Swell RMS Value (between 10% and 90% "Nominal_Star_Voltage") @ n-2	Float	R	
43429	V_SWELL_YEAR_N_2	Voltage Swell Year @ n-2	Unsigned short	R	
43430	V_SWELL_MONTH_N_2	Voltage Swell Month @ n-2	Unsigned short	R	
43431	V_SWELL_DAY_N_2	Voltage Swell Day @ n-2	Unsigned short	R	
43432	V_SWELL_HOUR_N_2	Voltage Swell Hour @ n-2	Unsigned short	R	
43433	V_SWELL_MINUTE_N_2	Voltage Swell Minute @ n-2	Unsigned short	R	
43434	V_SWELL_SECOND_N_2	Voltage Swell Second @ n-2	Unsigned short	R	
43435	V_SWELL_DURATION_N_2	Voltage Swell Duration [ms] @ n-2	Unsigned short	R	
43436	V_SWELL_QUERY_N_2	Voltage Swell Type: 0: ND 1: V_L1N 2: V_L2N 3: V_L3N 4: V_L1L2 5: V_L2L3 6: V_L3L1	Unsigned short	R	
43437	V_SWELL_VALUE_N_3	Voltage Swell RMS Value (between 10% and 90% "Nominal_Star_Voltage") @ n-3	Float	R	
43439	V_SWELL_YEAR_N_3	Voltage Swell Year @ n-3	Unsigned short	R	
43440	V_SWELL_MONTH_N_3	Voltage Swell Month @ n-3	Unsigned short	R	
43441	V_SWELL_DAY_N_3	Voltage Swell Day @ n-3	Unsigned short	R	
43442	V_SWELL_HOUR_N_3	Voltage Swell Hour @ n-3	Unsigned short	R	
43443	V_SWELL_MINUTE_N_3	Voltage Swell Minute @ n-3	Unsigned short	R	
43444	V_SWELL_SECOND_N_3	Voltage Swell Second @ n-3	Unsigned short	R	
43445	V_SWELL_DURATION_N_3	Voltage Swell Duration [ms] @ n-3	Unsigned short	R	
43446	V_SWELL_QUERY_N_3	Voltage Swell Type: 0: ND 1: V_L1N 2: V_L2N 3: V_L3N 4: V_L1L2 5: V_L2L3 6: V_L3L1	Unsigned short	R	
43447	V_SWELL_VALUE_N_4	Voltage Swell RMS Value (between 10% and 90% "Nominal_Star_Voltage") @ n-4	Float	R	
43449	V_SWELL_YEAR_N_4	Voltage Swell Year @ n-4	Unsigned short	R	
43450	V_SWELL_MONTH_N_4	Voltage Swell Month @ n-4	Unsigned short	R	
43451	V_SWELL_DAY_N_4	Voltage Swell Day @ n-4	Unsigned short	R	
43452	V_SWELL_HOUR_N_4	Voltage Swell Hour @ n-4	Unsigned short	R	
43453	V_SWELL_MINUTE_N_4	Voltage Swell Minute @ n-4	Unsigned short	R	
43454	V_SWELL_SECOND_N_4	Voltage Swell Second @ n-4	Unsigned short	R	
43455	V_SWELL_DURATION_N_4	Voltage Swell Duration [ms] @ n-4	Unsigned short	R	
43456	V_SWELL_QUERY_N_4	Voltage Swell Type: 0: ND 1: V_L1N 2: V_L2N 3: V_L3N 4: V_L1L2 5: V_L2L3 6: V_L3L1	Unsigned short	R	

43457	V_SWELL_VALUE_N_5	Voltage Swell RMS Value (between 10% and 90% "Nominal_Star_Voltage") @ n-5	Float	R	
43459	V_SWELL_YEAR_N_5	Voltage Swell Year @ n-5	Unsigned short	R	
43460	V_SWELL_MONTH_N_5	Voltage Swell Month @ n-5	Unsigned short	R	
43461	V_SWELL_DAY_N_5	Voltage Swell Day @ n-5	Unsigned short	R	
43462	V_SWELL_HOUR_N_5	Voltage Swell Hour @ n-5	Unsigned short	R	
43463	V_SWELL_MINUTE_N_5	Voltage Swell Minute @ n-5	Unsigned short	R	
43464	V_SWELL_SECOND_N_5	Voltage Swell Second @ n-5	Unsigned short	R	
43465	V_SWELL_DURATION_N_5	Voltage Swell Duration [ms] @ n-5	Unsigned short	R	
43466	V_SWELL_QUERY_N_5	Voltage Swell Type: 0: ND 1: V_L1N 2: V_L2N 3: V_L3N 4: V_L1L2 5: V_L2L3 6: V_L3L1	Unsigned short	R	
43467	V_SWELL_VALUE_N_6	Voltage Swell RMS Value (between 10% and 90% "Nominal_Star_Voltage") @ n-6	Float	R	
43469	V_SWELL_YEAR_N_6	Voltage Swell Year @ n-6	Unsigned short	R	
43470	V_SWELL_MONTH_N_6	Voltage Swell Month @ n-6	Unsigned short	R	
43471	V_SWELL_DAY_N_6	Voltage Swell Day @ n-6	Unsigned short	R	
43472	V_SWELL_HOUR_N_6	Voltage Swell Hour @ n-6	Unsigned short	R	
43473	V_SWELL_MINUTE_N_6	Voltage Swell Minute @ n-6	Unsigned short	R	
43474	V_SWELL_SECOND_N_6	Voltage Swell Second @ n-6	Unsigned short	R	
43475	V_SWELL_DURATION_N_6	Voltage Swell Duration [ms] @ n-6	Unsigned short	R	
43476	V_SWELL_QUERY_N_6	Voltage Swell Type: 0: ND 1: V_L1N 2: V_L2N 3: V_L3N 4: V_L1L2 5: V_L2L3 6: V_L3L1	Unsigned short	R	
43477	V_SWELL_VALUE_N_7	Voltage Swell RMS Value (between 10% and 90% "Nominal_Star_Voltage") @ n-7	Float	R	
43479	V_SWELL_YEAR_N_7	Voltage Swell Year @ n-7	Unsigned short	R	
43480	V_SWELL_MONTH_N_7	Voltage Swell Month @ n-7	Unsigned short	R	
43481	V_SWELL_DAY_N_7	Voltage Swell Day @ n-7	Unsigned short	R	
43482	V_SWELL_HOUR_N_7	Voltage Swell Hour @ n-7	Unsigned short	R	
43483	V_SWELL_MINUTE_N_7	Voltage Swell Minute @ n-7	Unsigned short	R	
43484	V_SWELL_SECOND_N_7	Voltage Swell Second @ n-7	Unsigned short	R	
43485	V_SWELL_DURATION_N_7	Voltage Swell Duration [ms] @ n-7	Unsigned short	R	
43486	V_SWELL_QUERY_N_7	Voltage Swell Type: 0: ND 1: V_L1N 2: V_L2N 3: V_L3N 4: V_L1L2 5: V_L2L3 6: V_L3L1	Unsigned short	R	
43487	V_SWELL_VALUE_N_8	Voltage Swell RMS Value (between 10% and 90% "Nominal_Star_Voltage") @ n-8	Float	R	
43489	V_SWELL_YEAR_N_8	Voltage Swell Year @ n-8	Unsigned short	R	
43490	V_SWELL_MONTH_N_8	Voltage Swell Month @ n-8	Unsigned short	R	
43491	V_SWELL_DAY_N_8	Voltage Swell Day @ n-8	Unsigned short	R	
43492	V_SWELL_HOUR_N_8	Voltage Swell Hour @ n-8	Unsigned short	R	
43493	V_SWELL_MINUTE_N_8	Voltage Swell Minute @ n-8	Unsigned short	R	
43494	V_SWELL_SECOND_N_8	Voltage Swell Second @ n-8	Unsigned short	R	
43495	V_SWELL_DURATION_N_8	Voltage Swell Duration [ms] @ n-8	Unsigned short	R	
43496	V_SWELL_QUERY_N_8	Voltage Swell Type: 0: ND 1: V_L1N 2: V_L2N 3: V_L3N 4: V_L1L2 5: V_L2L3 6: V_L3L1	Unsigned short	R	

43497	V_SWELL_VALUE_N_9	Voltage Swell RMS Value (between 10% and 90% "Nominal_Star_Voltage") @ n-9	Float	R	
43499	V_SWELL_YEAR_N_9	Voltage Swell Year @ n-9	Unsigned short	R	
43500	V_SWELL_MONTH_N_9	Voltage Swell Month @ n-9	Unsigned short	R	
43501	V_SWELL_DAY_N_9	Voltage Swell Day @ n-9	Unsigned short	R	
43502	V_SWELL_HOUR_N_9	Voltage Swell Hour @ n-9	Unsigned short	R	
43503	V_SWELL_MINUTE_N_9	Voltage Swell Minute @ n-9	Unsigned short	R	
43504	V_SWELL_SECOND_N_9	Voltage Swell Second @ n-9	Unsigned short	R	
43505	V_SWELL_DURATION_N_9	Voltage Swell Duration [ms] @ n-9	Unsigned short	R	
43506	V_SWELL_QUERY_N_9	Voltage Swell Type: 0: ND 1: V_L1N 2: V_L2N 3: V_L3N 4: V_L1L2 5: V_L2L3 6: V_L3L1	Unsigned short	R	
43507	V_SWELL_VALUE_EEPROM	Voltage Swell RMS Value (between 10% and 90% "Nominal_Star_Voltage") EEPROM Data	Float	R	
43509	V_SWELL_YEAR_EEPROM	Voltage Swell Year EEPROM Data	Unsigned short	R	
43510	V_SWELL_MONTH_EEPROM	Voltage Swell Month EEPROM Data	Unsigned short	R	
43511	V_SWELL_DAY_EEPROM	Voltage Swell Day EEPROM Daten	Unsigned short	R	
43512	V_SWELL_HOUR_EEPROM	Voltage Swell Hour EEPROM Daten	Unsigned short	R	
43513	V_SWELL_MINUTE_EEPROM	Voltage Swell Minute EEPROM Daten	Unsigned short	R	
43514	V_SWELL_SECOND_EEPROM	Voltage Swell Second EEPROM Daten	Unsigned short	R	
43515	V_SWELL_DURATION_EEPROM	Voltage Swell Duration [ms] EEPROM Daten	Unsigned short	R	
43516	U_SWELL_Query_EEPROM	Voltage Swell Type: 0: ND 1: V_L1N 2: V_L2N 3: V_L3N 4: V_L1L2 5: V_L2L3 6: V_L3L1	Unsigned short	R	
43517	V_INERRUPTION_VALUE_N_0	Voltage INERRUPTION RMS Value (between 10% and 90% "Nominal_Star_Voltage") @ n-0	Float	R	
43519	V_INERRUPTION_YEAR_N_0	Voltage INERRUPTION Year @ n-0	Unsigned short	R	
43520	V_INERRUPTION_MONTH_N_0	Voltage INERRUPTION Month @ n-0	Unsigned short	R	
43521	V_INERRUPTION_DAY_N_0	Voltage INERRUPTION Day @ n-0	Unsigned short	R	
43522	V_INERRUPTION_HOUR_N_0	Voltage INERRUPTION Hour @ n-0	Unsigned short	R	
43523	V_INERRUPTION_MINUTE_N_0	Voltage INERRUPTION Minute @ n-0	Unsigned short	R	
43524	V_INERRUPTION_SECOND_N_0	Voltage INERRUPTION Second @ n-0	Unsigned short	R	
43525	V_INERRUPTION_DURATION_N_0	Voltage INERRUPTION Duration [ms] @ n-0	Unsigned short	R	
43526	V_INERRUPTION_QUERY_N_0	Voltage INERRUPTION Type: 0: ND 1: V_L1N 2: V_L2N 3: V_L3N 4: V_L1L2 5: V_L2L3 6: V_L3L1	Unsigned short	R	
43527	V_INERRUPTION_VALUE_N_1	Voltage INERRUPTION RMS Value (between 10% and 90% "Nominal_Star_Voltage") @ n-1	Float	R	
43529	V_INERRUPTION_YEAR_N_1	Voltage INERRUPTION Year @ n-1	Unsigned short	R	
43530	V_INERRUPTION_MONTH_N_1	Voltage INERRUPTION Month @ n-1	Unsigned short	R	

43531	V_INERRUPTION_ DAY_N_1	Voltage INERRUPTION Day @ n-1	Unsigned short	R	
43532	V_INERRUPTION_ HOUR_N_1	Voltage INERRUPTION Hour @ n-1	Unsigned short	R	
43533	V_INERRUPTION_ MINUTE_N_0	Voltage INERRUPTION Minute @ n-0	Unsigned short	R	
43534	V_INERRUPTION_ SECOND_N_0	Voltage INERRUPTION Second @ n-0	Unsigned short	R	
43535	V_INERRUPTION_ DURATION_N_0	Voltage INERRUPTION Duration [ms] @ n-0	Unsigned short	R	
43536	V_INERRUPTION_ QUERY_N_1	Voltage INERRUPTION Type: 0: ND 1: V_L1N 2: V_L2N 3: V_L3N 4: V_L1L2 5: V_L2L3 6: V_L3L1	Unsigned short	R	
43537	V_INERRUPTION_ VALUE_N_2	Voltage INERRUPTION RMS Value (between 10% and 90% "Nominal_Star_Voltage") @ n-2	Float	R	
43539	V_INERRUPTION_ YEAR_N_2	Voltage INERRUPTION Year @ n-2	Unsigned short	R	
43540	V_INERRUPTION_ MONTH_N_2	Voltage INERRUPTION Month @ n-2	Unsigned short	R	
43541	V_INERRUPTION_ DAY_N_2	Voltage INERRUPTION Day @ n-2	Unsigned short	R	
43542	V_INERRUPTION_ HOUR_N_2	Voltage INERRUPTION Hour @ n-2	Unsigned short	R	
43543	V_INERRUPTION_ MINUTE_N_2	Voltage INERRUPTION Minute @ n-2	Unsigned short	R	
43544	V_INERRUPTION_ SECOND_N_2	Voltage INERRUPTION Second @ n-2	Unsigned short	R	
43545	V_INERRUPTION_ DURATION_N_2	Voltage INERRUPTION Duration [ms] @ n-2	Unsigned short	R	
43546	V_INERRUPTION_ QUERY_N_2	Voltage INERRUPTION Type: 0: ND 1: V_L1N 2: V_L2N 3: V_L3N 4: V_L1L2 5: V_L2L3 6: V_L3L1	Unsigned short	R	
43547	V_INERRUPTION_ VALUE_N_3	Voltage INERRUPTION RMS Value (between 10% and 90% "Nominal_Star_Voltage") @ n-3	Float	R	
43549	V_INERRUPTION_ YEAR_N_3	Voltage INERRUPTION Year @ n-3	Unsigned short	R	
43550	V_INERRUPTION_ MONTH_N_3	Voltage INERRUPTION Month @ n-3	Unsigned short	R	
43551	V_INERRUPTION_ DAY_N_3	Voltage INERRUPTION Day @ n-3	Unsigned short	R	
43552	V_INERRUPTION_ HOUR_N_3	Voltage INERRUPTION Hour @ n-3	Unsigned short	R	
43553	V_INERRUPTION_ MINUTE_N_3	Voltage INERRUPTION Minute @ n-3	Unsigned short	R	
43554	V_INERRUPTION_ SECOND_N_3	Voltage INERRUPTION Second @ n-3	Unsigned short	R	
43555	V_INERRUPTION_ DURATION_N_3	Voltage INERRUPTION Duration [ms] @ n-3	Unsigned short	R	
43556	V_INERRUPTION_ QUERY_N_3	Voltage INERRUPTION Type: 0: ND 1: V_L1N 2: V_L2N 3: V_L3N 4: V_L1L2 5: V_L2L3 6: V_L3L1	Unsigned short	R	
43557	V_INERRUPTION_ VALUE_N_4	Voltage INERRUPTION RMS Value (between 10% and 90% "Nominal_Star_Voltage") @ n-4	Float	R	

43559	V_INERRUPTION_YEAR_N_4	Voltage INERRUPTION Year @ n-4	Unsigned short	R	
43560	V_INERRUPTION_MONTH_N_4	Voltage INERRUPTION Month @ n-4	Unsigned short	R	
43561	V_INERRUPTION_DAY_N_4	Voltage INERRUPTION Day @ n-4	Unsigned short	R	
43562	V_INERRUPTION_HOUR_N_4	Voltage INERRUPTION Hour @ n-4	Unsigned short	R	
43563	V_INERRUPTION_MINUTE_N_4	Voltage INERRUPTION Minute @ n-4	Unsigned short	R	
43564	V_INERRUPTION_SECOND_N_4	Voltage INERRUPTION Second @ n-4	Unsigned short	R	
43565	V_INERRUPTION_DURATION_N_4	Voltage INERRUPTION Duration [ms] @ n-4	Unsigned short	R	
43566	V_INERRUPTION_QUERY_N_4	Voltage INERRUPTION Type: 0: ND 1: V_L1N 2: V_L2N 3: V_L3N 4: V_L1L2 5: V_L2L3 6: V_L3L1	Unsigned short	R	
43567	V_INERRUPTION_VALUE_N_5	Voltage INERRUPTION RMS Value (between 10% and 90% "Nominal_Star_Voltage") @ n-5	Float	R	
43569	V_INERRUPTION_YEAR_N_5	Voltage INERRUPTION Year @ n-5	Unsigned short	R	
43570	V_INERRUPTION_MONTH_N_5	Voltage INERRUPTION Month @ n-5	Unsigned short	R	
43571	V_INERRUPTION_DAY_N_5	Voltage INERRUPTION Day @ n-5	Unsigned short	R	
43572	V_INERRUPTION_HOUR_N_5	Voltage INERRUPTION Hour @ n-5	Unsigned short	R	
43573	V_INERRUPTION_MINUTE_N_5	Voltage INERRUPTION Minute @ n-5	Unsigned short	R	
43574	V_INERRUPTION_SECOND_N_5	Voltage INERRUPTION Second @ n-5	Unsigned short	R	
43575	V_INERRUPTION_DURATION_N_5	Voltage INERRUPTION Duration [ms] @ n-5	Unsigned short	R	
43576	V_INERRUPTION_QUERY_N_5	Voltage INERRUPTION Type: 0: ND 1: V_L1N 2: V_L2N 3: V_L3N 4: V_L1L2 5: V_L2L3 6: V_L3L1	Unsigned short	R	
43577	V_INERRUPTION_VALUE_N_6	Voltage INERRUPTION RMS Value (between 10% and 90% "Nominal_Star_Voltage") @ n-6	Float	R	
43579	V_INERRUPTION_YEAR_N_6	Voltage INERRUPTION Year @ n-6	Unsigned short	R	
43580	V_INERRUPTION_MONTH_N_6	Voltage INERRUPTION Month @ n-6	Unsigned short	R	
43581	V_INERRUPTION_DAY_N_6	Voltage INERRUPTION Day @ n-6	Unsigned short	R	
43582	V_INERRUPTION_HOUR_N_6	Voltage INERRUPTION Hour @ n-6	Unsigned short	R	
43583	V_INERRUPTION_MINUTE_N_6	Voltage INERRUPTION Minute @ n-6	Unsigned short	R	
43584	V_INERRUPTION_SECOND_N_6	Voltage INERRUPTION Second @ n-6	Unsigned short	R	
43585	V_INERRUPTION_DURATION_N_6	Voltage INERRUPTION Duration [ms] @ n-6	Unsigned short	R	
43586	V_INERRUPTION_QUERY_N_6	Voltage INERRUPTION Type: 0: ND 1: V_L1N 2: V_L2N 3: V_L3N 4: V_L1L2 5: V_L2L3 6: V_L3L1	Unsigned short	R	

43587	V_INERRUPTION_VALUE_N_7	Voltage INERRUPTION RMS Value (between 10% and 90% "Nominal_Star_Voltage") @ n-7	Float	R	
43589	V_INERRUPTION_YEAR_N_7	Voltage INERRUPTION Year @ n-7	Unsigned short	R	
43590	V_INERRUPTION_MONTH_N_7	Voltage INERRUPTION Month @ n-7	Unsigned short	R	
43591	V_INERRUPTION_DAY-N_N_7	Voltage INERRUPTION Day @ n-7	Unsigned short	R	
43592	V_INERRUPTION_HOUR_N_7	Voltage INERRUPTION Hour @ n-7	Unsigned short	R	
43593	V_INERRUPTION_MINUTE_N_7	Voltage INERRUPTION Minute @ n-7	Unsigned short	R	
43594	V_INERRUPTION_SECOND_N_7	Voltage INERRUPTION Second @ n-7	Unsigned short	R	
43595	V_INERRUPTION_DURATION_N_7	Voltage INERRUPTION Duration [ms] @ n-7	Unsigned short	R	
43596	V_INERRUPTION_QUERY_N_7	Voltage INERRUPTION Type: 0: ND 1: V_L1N 2: V_L2N 3: V_L3N 4: V_L1L2 5: V_L2L3 6: V_L3L1	Unsigned short	R	
43597	V_INERRUPTION_VALUE_N_8	Voltage INERRUPTION RMS Value (between 10% and 90% "Nominal_Star_Voltage") @ n-8	Float	R	
43599	V_INERRUPTION_YEAR_N_8	Voltage INERRUPTION Year @ n-8	Unsigned short	R	
43600	V_INERRUPTION_MONTH_N_8	Voltage INERRUPTION Month @ n-8	Unsigned short	R	
43601	V_INERRUPTION_DAY_N_8	Voltage INERRUPTION Day @ n-8	Unsigned short	R	
43602	V_INERRUPTION_HOUR_N_8	Voltage INERRUPTION Hour @ n-8	Unsigned short	R	
43603	V_INERRUPTION_MINUTE_N_8	Voltage INERRUPTION Minute @ n-8	Unsigned short	R	
43604	V_INERRUPTION_SECOND_N_8	Voltage INERRUPTION Second @ n-8	Unsigned short	R	
43605	V_INERRUPTION_DURATION_N_8	Voltage INERRUPTION Duration [ms] @ n-8	Unsigned short	R	
43606	V_INERRUPTION_QUERY_N_8	Voltage INERRUPTION Type: 0: ND 1: V_L1N 2: V_L2N 3: V_L3N 4: V_L1L2 5: V_L2L3 6: V_L3L1	Unsigned short	R	
43607	V_INERRUPTION_VALUE_N_9	Voltage INERRUPTION RMS Value (between 10% and 90% "Nominal_Star_Voltage") @ n-9	Float	R	
43609	V_INERRUPTION_YEAR_N_9	Voltage INERRUPTION Year @ n-9	Unsigned short	R	
43610	V_INERRUPTION_MONTH_N_9	Voltage INERRUPTION Month @ n-9	Unsigned short	R	
43611	V_INERRUPTION_DAY_N_9	Voltage INERRUPTION Day @ n-9	Unsigned short	R	
43612	V_INERRUPTION_HOUR_N_9	Voltage INERRUPTION Hour @ n-9	Unsigned short	R	
43613	V_INERRUPTION_MINUTE_N_9	Voltage INERRUPTION Minute @ n-9	Unsigned short	R	
43614	V_INERRUPTION_SECOND_N_9	Voltage INERRUPTION Second @ n-9	Unsigned short	R	
43615	V_INERRUPTION_DURATION_N_9	Voltage INERRUPTION Duration [ms] @ n-9	Unsigned short	R	

43616	V_INERRUPTION_QUERY_N_9	Voltage INERRUPTION Type: 0: ND 1: V_L1N 2: V_L2N 3: V_L3N 4: V_L1L2 5: V_L2L3 6: V_L3L1	Unsigned short	R	
43617	V_INERRUPTION_VALUE_EEPROM	Voltage INERRUPTION RMS Value (between 10% and 90% "Nominal_Star_Voltage") EEPROM Data	Float	R	
43619	V_INERRUPTION_YEAR_EEPROM	Voltage INERRUPTION Year EEPROM Data	Unsigned short	R	
43620	V_INERRUPTION_MONTH_EEPROM	Voltage INERRUPTION Month EEPROM Data	Unsigned short	R	
43621	V_INERRUPTION_DAY_EEPROM	Voltage INERRUPTION Day EEPROM Data	Unsigned short	R	
43622	V_INERRUPTION_HOUR_EEPROM	Voltage INERRUPTION Hour EEPROM Data	Unsigned short	R	
43623	V_INERRUPTION_MINUTE_EEPROM	Voltage INERRUPTION Minute EEPROM Data	Unsigned short	R	
43624	V_INERRUPTION_SECOND_EEPROM	Voltage INERRUPTION Second EEPROM Data	Unsigned short	R	
43625	V_INERRUPTION_DURATION_EEPROM	Voltage INERRUPTION Duration [ms] EEPROM Data	Unsigned short	R	
43626	V_INERRUPTION_QUERY_EEPROM	Voltage INERRUPTION Type: 0: ND 1: V_L1N 2: V_L2N 3: V_L3N 4: V_L1L2 5: V_L2L3 6: V_L3L1	Unsigned short	R	
43627 up to 43881	U_L1N_Oscilloscope_0...127	Star voltage L1-N Sample #0 ... #127	Float	R	
43883 up to 44137	U_L2N_Oscilloscope_0...127	Star voltage L2-N Sample #0 ... #127	Float	R	
44139 up to 44393	U_L3N_Oscilloscope_0...127	Star voltage L3-N Sample #0 ... #127	Float	R	
44395 up to 44649	U_L12_Oscilloscope_0...127	Line voltage L1-L2 Sample #0 ... #127	Float	R	
44651 up to 44905	U_L23_Oscilloscope_0...127	Line voltage L2-L3 Sample #0 ... #127	Float	R	
44907 up to 45161	U_L31_Oscilloscope_0...127	Line voltage L3-L1 Sample #0 ... #127	Float	R	
45163 up to 45417	I_L1_Oscilloscope_0...127	Strom L1 Sample #0 ... #127	Float	R	
45419 up to 45673	I_L2_Oscilloscope_0...127	Current L2 Sample #0 ... #127	Float	R	
45675 up to 45929	I_L3_Oscilloscope_0...127	Current L3 Sample #0 ... #127	Float	R	
45931 up to 46185	I_N_Oscilloscope_0...127	Current N Sample #0 ... #127	Float	R	

8. Identification of the type label

SIRAX MT7100





Article-No.: 180034
20161118105725
HW: 04 FW: 001 M. ID: 25

SIRAX MT7150

Article-No.: 180042
20161118105725
HW: 04 FW: 001 M. ID: 25

Camille Bauer Metrawatt AG
Aargauerstrasse 7
5610 Wohlen / Switzerland

9. Sign explanation

Symbol	Signification
	Device may only be disposed of in a professional manner!
	CE conformity mark. The device fulfills the requirements of the applicable EC directives. See declaration of conformity.
	Caution! General hazard point. Read the operating instructions.
	Attention: Danger to life!
	Please note

10. Dimensions

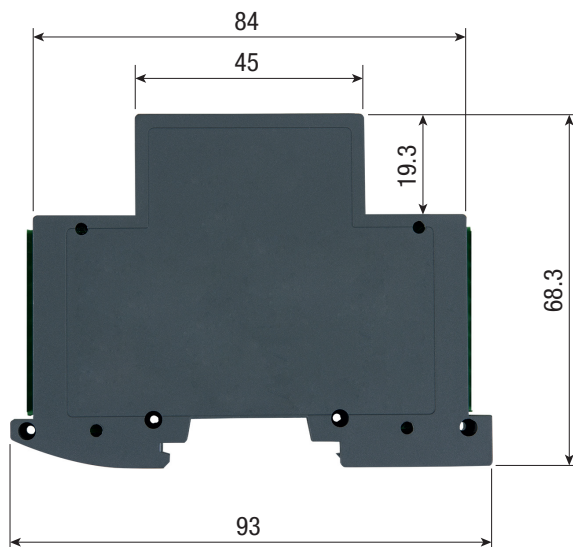

SIRAX MT7100 / MT7150