

Device handbook

SIRAX BM1400

Operating Instructions universal multifunctional monitor



Camille Bauer Metrawatt AG
Aargauerstrasse 7
CH-5610 Wohlen/Switzerland

Tel: +41 56 618 21 11
Fax: +41 56 618 21 21

info@cbmag.com
www.camillebauer.com

Table of contents

1. Legal information	3
1.1 Safety and warning notices	3
1.2 Qualified personal	3
1.3 Intended use	3
1.4 Disclaimer of liability	3
1.5 Feedback	3
1.6 Repair work and modifications	3
1.7 Calibration and new adjustment	3
1.8 Cleaning	4
1.9 Disposal	4
1.10 Return	4
2. Introduction	4
2.1 Purpose of this document	4
2.2 Scope of supply	4
2.3 Further documents	4
3. Device overview	5
3.1 Brief description	5
3.2 Available measurement data	5
4. Mechanical mounting	6
4.1 Panel cut out	6
4.2 Mounting of the device	6
4.3 Demounting of the device	6
5. Electrical connections	7
5.1 General safety notes	7
5.2 Possible cross sections and tightening torques	7
5.3 Inputs	8
5.4 Power supply	8
5.5 Modbus interface RS485	8
6. Commissioning	9
6.1 Operating the device	9
6.2 Measurement Reading Screens	9
7. Programming	12
7.1. Password Protection	12
7.2 Menu selection	13
7.2.1 System Parameter selection screen	13
7.2.2 Communication Parameter selection screen	13
7.2.3 Reset Parameter selection screen	13
7.2.4 Output Option selection screen	13
7.2.5 Quit screen	13
8. Phase Rotation Error screen	20
9. Run hour	20
10. On hour	20
11. Number of Interruption	20
12. Analog Output (optional)	20
13. Relay output (Optional)	22
13.1 Pulse Output	22
13.2 Limit Switch	23
14. Technical data	24
14.1 Dimensional drawings	27
14.2 Phasor diagram	27
14.3 Connection and programming via Ethernet RS485 (Modbus RTU) interface	28
14.4 Connection and programming via Ethernet RJ45 (Modbus TCP) interface	28
15. Interface Definition Modbus (RS485)	29
15.1 Modbus functions	29
15.2 Data types	29

1. Legal information

1.1 Safety and warning notices

In this document safety and warning notices are used, which you have to observe to ensure personal safety and to prevent damage to property.



If the warning notice is not followed death or severe personal injury **will** result.



If the warning notice is not followed damage to property or severe personal injury **may** result.



If the warning notice is not followed the device **may** be damaged or **may** not fulfill the expected functionality.



The installation and commissioning should only be carried out by trained personnel. Check the following points before commissioning:

- that the maximum values for all the connections are not exceeded, see „Technical data“ section,
- that the connection wires are not damaged, and that they are not live during wiring,
- that the power flow direction and the phase rotation are correct.

The instrument must be taken out of service if safe operation is no longer possible (e.g. visible damage). In this case, all the connections must be switched off. The instrument must be returned to the factory or to an authorized service dealer.

It is forbidden to open the housing and to make modifications to the instrument. The instrument is not equipped with an integrated circuit breaker. During installation check that a labeled switch is installed and that it can easily be reached by the operators.

Unauthorized repair or alteration of the unit invalidates the warranty.



Please observe that the data on the type plate must be adhered to!

The national provisions have to be observed in the installation and material selection of electric lines!

1.2 Qualified personnel

The product described in this document may be handled by personnel only, which is qualified for the respective task. Qualified personnel have the training and experience to identify risks and potential hazards when working with the product. Qualified personnel are also able to understand and follow the given safety and warning notices.

1.3 Intended use

The product described in this document may be used only for the application specified. The maximum electrical supply data and ambient conditions specified in the technical data section must be adhered. For the perfect and safe operation of the device proper transport and storage as well as professional assembly, installation, handling and maintenance are required.

1.4 Disclaimer of liability

The content of this document has been reviewed to ensure correctness. Nevertheless it may contain errors or inconsistencies and we cannot guarantee completeness and correctness. This is especially true for different language versions of this document. This document is regularly reviewed and updated. Necessary corrections will be included in subsequent version and are available via our webpage www.camillebauer.com.

1.5 Feedback

If you detect errors in this document or if there is necessary information missing, please inform us via e-mail to: customer-support@camillebauer.com

1.6 Repair work and modifications

Repair work and modifications shall exclusively be carried out by the manufacturer. Do not open the housing of the device. In case of any tampering with the device, the guaranty claim shall lapse. We reserve the right of changing the product to improve it.

1.7 Calibration and new adjustment

Each device is adjusted and checked before delivery. The condition as supplied to the customer is measured and stored in electronic form. The uncertainty of measurement devices may be altered during normal operation if, for example, the specified ambient conditions are not met.

1.8 Cleaning

The display and the control buttons should be cleaned at regular intervals. Use a dry or slightly damp cloth.



Damage caused by cleaning agents

Detergents can not only affect the clarity of the display, but also cause damage to the device. Therefore, do not use detergents.

1.9 Disposal



Device may only be disposed in a professional manner!

The disposal of devices and components may only be realised in accordance with good professional practice observing the country-specific regulations. Incorrect disposal can cause environmental risks.

1.10 Return

All devices delivered to Camille Bauer Metrawatt AG shall be free of any hazardous contaminants (acids, lyes, solutions, etc.). Use original packaging or suitable transport packaging to return the device.



Damage by returning

Damages caused by improper returning, no warranties or guarantees can be given.

2. Introduction

2.1 Purpose of this document

This document describes the multifunctional measuring device SIRAX BM1400. It is intended to be used by Installers and commissioners, Service and maintenance personnel, as well as Planner.

Scope

This handbook is valid for all versions of the SIRAX BM1400. Some of the functions described in this document are available only, if the necessary optional components are included in the device.

Required knowledge

A general knowledge in the field of electrical engineering is required. For assembly and installation of the device knowledge of applicable national safety regulations and installation standard is required.

2.2 Scope of supply

- Measurement device SIRAX BM1400
- Safety instructions (multiple languages)
- Connection set: 4 mounting clamps

2.3 Further documents

Folgende weitere Dokumente zum Gerät sind elektronisch via www.camillebauer.com verfügbar:

- Safety instructions SIRAX BM140
- Operating Instructions SIRAX BM1400
- Manual Modbus/TCP interface

3. Device overview

3.1 Brief description

The universal measuring device SIRAX BM1400 is suited for fixed mounting and the measurement of Voltage, current, frequency, power, energy (active / reactive / apparent), power factor, phase angle, etc in low voltage switchgear. The units are designed for unbalanced load network forms of 3-phase mains with 3- or 4-wire.

3.2 Available measurement data

Measured Parameters	Units	3P 3W	3P 4W
System Voltage U	V	•	•
Voltage U1N / U2N / U3N	V	–	•
Voltage U12 / U23 / U31	V	•	•
System Current I	A	•	•
Current IL1 / IL2 / IL3	A	•	•
Neutral Current IN	A	–	•
Frequency F	Hz	•	•
Active Power P / P1 / P2 / P3	kW	–	•
Reactive Power Q / Q1 / Q2 / Q3	kVAr	–	•
Apparent Power S / S1 / S2 / S3	kVA	–	•
Power Factor PF1 / PF2 / PF3	–	–	•
Phase Angle Phi1 / Phi2 / Phi3	degree	–	•
Active Import Energy (8 Digit resolution)*	kWh	•	•
Active Export Energy (8 Digit resolution)*	kWh	•	•
Capacitive Reactive Energy (8 Digit resolution)*	kVArh	•	•
Inductive Reactive Energy (8 Digit resolution)*	kVArh	•	•
Apparent Energy (8 Digit resolution)*	kVAh	•	•
Current Demand	A	•	•
Max Current Demand	A	•	•
Apparent Power Demand	kVA	•	•
Max Apparent Power Demand	kVA	•	•
Import Active Power Demand	kW	•	•
Export Active Power Demand	kW	•	•
Max Import Active Power Demand	kW	•	•
Max Export Active Power Demand	kW	•	•
Run Hour	hours	•	•
On Hour	hours	•	•
Number of Interruptions	counts	•	•
Phase Rotation Error	–	•	•
Phase Absent Indication	–	•	•
Current Absent Indication	–	•	•
Voltage THD	%	•	•
Current THD	%	•	•
Min / Max System Voltage	V	•	•
Min / Max System Current	A	•	•

* Note: Units of these parameters will depend on „Energy Output“ (Refer section 7.2.1.10)

4. Mechanical mounting

The SIRAX BM1400 is designed for panel mounting.



Please ensure that the operating temperature limits are not exceeded when determining the place of mounting (place of measurement): **-10 ... +55° C**

4.1 Panel cut out

Dimensional drawing BM1400: See section 15.1

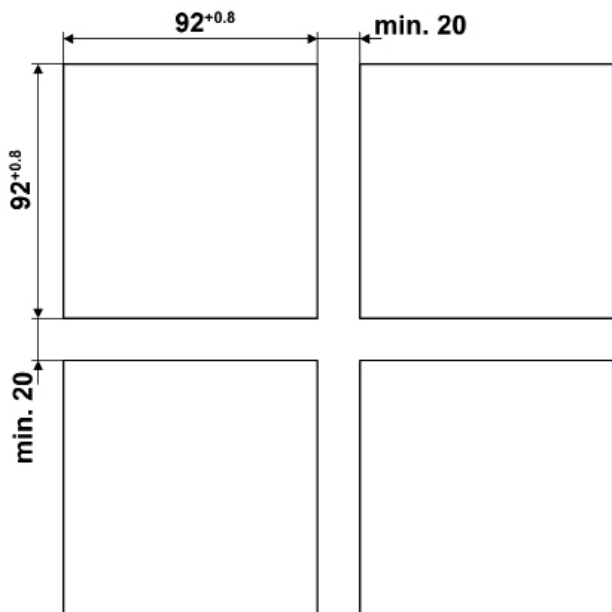

4.2 Mounting of the device

The device is suitable for panel widths up to 5mm and a panel cutout of 96 x 96 mm.

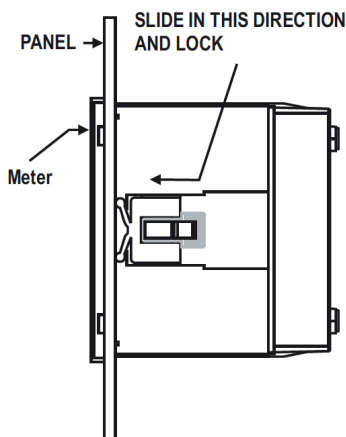

Variant with Mounting clamps

- Slide the device into the cutout from the outside
- Mounting is by four side clamps, slide the side clamps through side slot till side clamp gets firmly locked in a groove (Refer fig.) Consideration should be given to the space required behind the instrument to allow for bends in the connection cables.

4.3 Demounting of the device

The demounting of the device may be performed only if all connected wires are out of service. Remove all plug-in terminals and all connections of the current and voltage inputs. Pay attention to the fact, that current transformers must be shortened before removing the current connections to the device. Then demount the device in the opposite order of mounting (4.2).

5. Electrical connections



Ensure under all circumstances that the leads are free of potential when connecting them!

5.1 General safety notes



Please observe that the data on the type plate must be adhered to!

The national provisions have to be observed in the installation and material selection of electric lines!

Symbol	Meaning
	Device may only be disposed of in a professional manner!
	Double insulation, device of protection class 2
CAT III	Measurement category CAT III for current / voltage inputs, power supply and relay outputs
	CE conformity mark. The device fulfills the requirements of the applicable EC directives. See declaration of conformity.
	Caution! General hazard point. Read the operating instructions.
	Attention: Danger to life!
	Please note

5.2 Possible cross sections and tightening torques

Terminals 1 ... 14

Single wire: $\leq 4,0\text{mm}^2$ or multiwire with end splices: $2 \times 2,5\text{mm}^2$

Torque: 0.5 ... 0.6Nm resp. 4.42 ... 5.31 lbf in

Terminal A, B, G

Single wire: $\leq 1,5\text{mm}^2$ or multiwire with end splices: $2 \times 0,5\text{mm}^2$

Torque: max. 0.5 Nm resp. 4.42 lbf in

5.3 Inputs



All voltage measurement inputs must originate at circuit breakers or fuses rated by 1 Amps. This does not apply to the neutral connector. You have to provide a method for manually removing power from the device, such as a clearly labeled circuit breaker or a fused disconnect switch.

When using **voltage transformers** you have to ensure that their secondary connections never will be short-circuited.



No fuse may be connected upstream of the **current measurement inputs!**

When using **current transformers** their secondary connectors must be short-circuited during installation and before removing the device. Never open the secondary circuit under load.

The connection of the inputs depends on the configured system (connection type).

Three Phase - three wire system, unbalanced load (3PH, 3W)

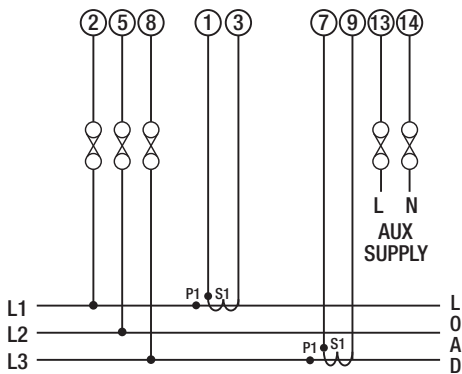

Direct connection

Three Phase - four wire system, unbalanced load (3PH, 4W)

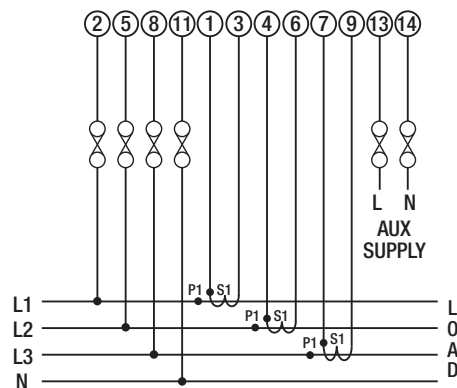

Direct connection

5.4 Power supply



A marked and easily accessible current limiting switch has to be arranged in the vicinity of the device for turning off the power supply. Fusing should be 10 Amps or less and must be rated for the available voltage and fault current.

5.5 Modbus interface RS485

Via the optional Modbus interface measurement data may be provided for a superior system. However, the Modbus interface cannot be used for device parameterization.

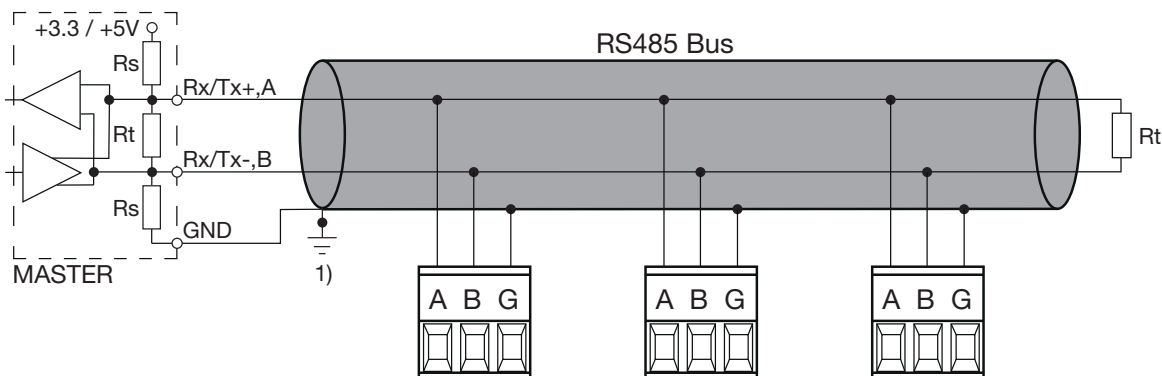

1) One ground connection only. This is possibly made within the master (PC).

Rt: Termination resistors: 120 Ω each for long cables (> approx. 10 m)

Rs: Bus supply resistors, 390 Ω each

The signal wires (A, B) have to be twisted. GND (G) can be connected via a wire or via the cable screen. In disturbed environments shielded cables must be used. Supply resistors (Rs) have to be present in bus master (PC) interface. Stubs should be avoided when connecting the devices. A pure daisy chain network is ideal.

You may connect up to 32 Modbus devices to the bus. A proper operation requires that all devices connected to the bus have equal communication settings (baud rate, transmission format) and unique Modbus addresses.

The bus system is operated half duplex and may be extended to a maximum length of 1200 m without repeater.

5.6 Modbus/TCP interface Ethernet (RJ45)

The device can be programmed via the optional Ethernet (RJ45) Modbus / TCP interface and measurement data can be provided for a superior system. The device is delivered with a factory preset IP address of "192.168.11.11". This can be changed in the programming software. You can find the exact instructions for this on our homepage "www.camillebauer.com" in the document "Manual Modbus/TCP interface".

6. Commissioning

SIRAX BM1400			
ORDER CODE: 174988			
SR No.: 15/11/0001			
CLASS: 0.5	CAT III 300V Max.	V18.05	
INPUT: 3PH. 440 V L - L, 5A/1A, 45...66Hz			
OPTION:			
AUXILIARY: 100...250V AC/DC, 4.5VA			

Label version standard

SIRAX BM1400			
ORDER CODE: 174996			
SR No.: 15/11/0001			
CLASS: 0.5	CAT III 300V Max.	V18.05	
INPUT: 3PH. 440 V L - L, 5A/1A, 45...66Hz			
OPTION: RS485 + 1PULSE + 2x4...20mA ANA.O/P			
AUXILIARY: 100...250V AC/DC, 4.5VA			

Label version with RS485

SIRAX BM1400			
ORDER CODE: 175001			
SR No.: 15/11/0001			
CLASS: 0.5	CAT III 300V Max.	V18.05	
INPUT: 3PH. 440 V L - L, 5A/1A, 45...66Hz			
OPTION: Ethernet			
AUXILIARY: 100...250V AC/DC, 4.5VA			

Label version with Ethernet

6.1 Operating the device



SIRAX BM1400 can be configured and programmed at site for the following: PT Primary, CT Primary, CT Secondary (5A or 1A) & three wire, three phase system or four wire, three phase system. The front panel has two push buttons through which the User may scroll through the available measurement readings, reset the energy (Import/Export) Min/Max (System Voltage & System Current) & configure the product.

Operation is performed by means of 2 keys:

- 2 keys "UP" and "DOWN" for navigation and for the selection of values.

6.2 Measurement Reading Screens

In normal operation the user is presented with one of the measurement reading screens out of several screens. These screens may be scrolled through one at a time in incremental order by pressing the " Up key" and in decremental order by pressing " Down key".

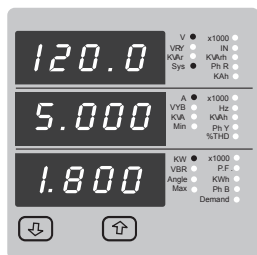

Screen 1: System screen (System Voltage, System Current, System Active Power)

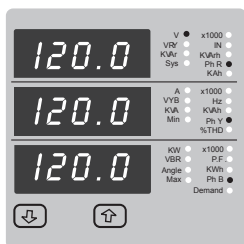

Screen 2: Line to Neutral Voltages (for 4 wire only)

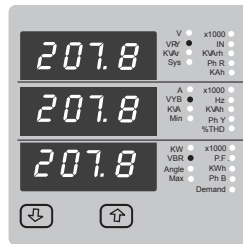

Screen 3: Line to Line Voltages

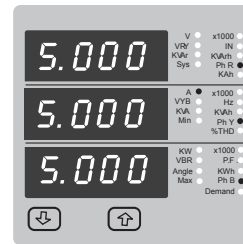

Screen 4: Line Currents

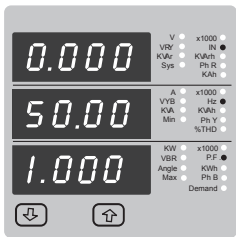

Screen 5: Neutral current (for 4W only), Frequency, Sys. Power Factor

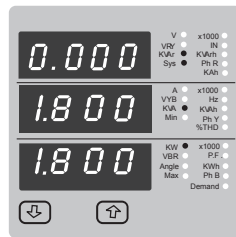

Screen 6: System Power (Reactive, Apparent, Active)

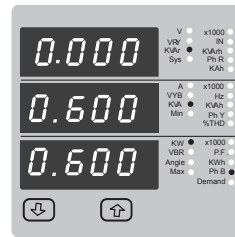

Screen 17: Phase Power (B) Reactive/Apparent/Active (for 4W only)

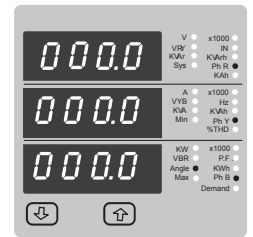

Screen 18: Phase Angle (Phase R / Y / B) (for 4W only)

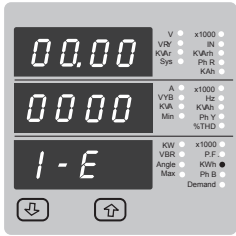

Screen 7: Active Energy (Import)

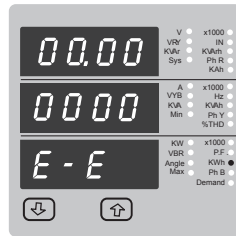

Screen 8: Active Energy (Export)

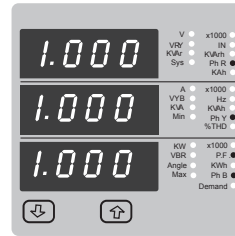

Screen 19: Phase Power Factor (Phase R/Y/B) (for 4W only)

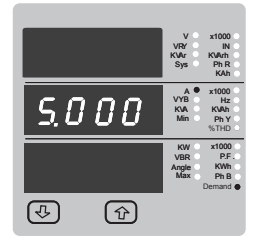

Screen 20: Current Demand

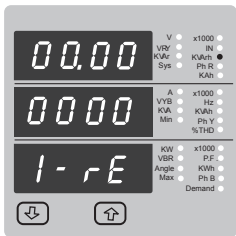

Screen 9: Reactive Energy (Import)

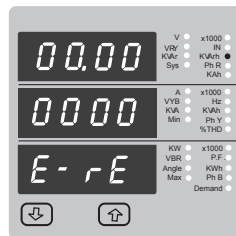

Screen 10: Reactive Energy(Export)

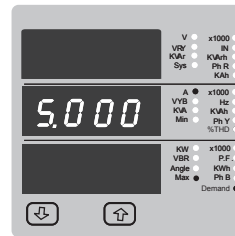

Screen 21: Max Current Demand

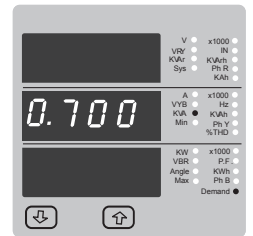

Screen 22: kVA Demand

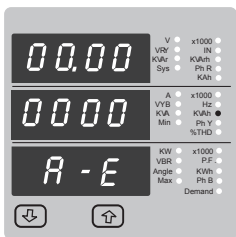

Screen 11: Apparent Energy

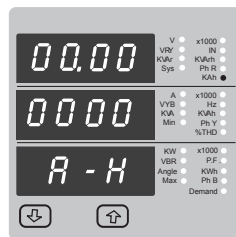

Screen 12: Ampere Hour

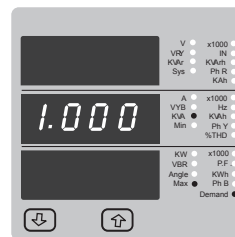

Screen 23: Max kVA Demand

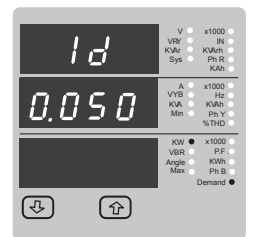

Screen 24: Import kW Demand

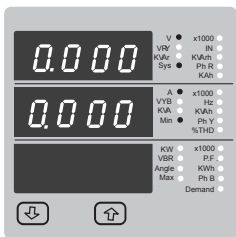

Screen 13: Min System Voltage & Current

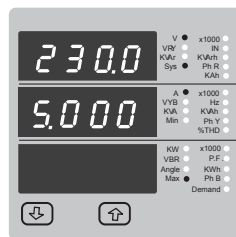

Screen 14: Max System Voltage & Current

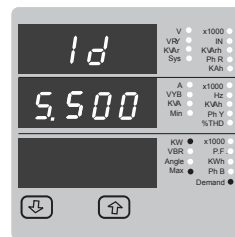

Screen 25: Max Import kW Demand

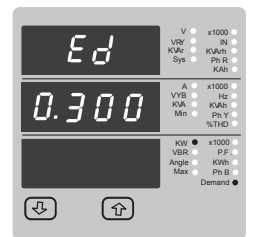

Screen 26: Export kW Demand

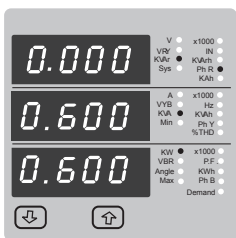

Screen 15: Phase Power (R) Reactive/Apparent/Active (for 4W only)

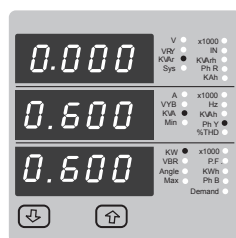

Screen 16: Phase Power (Y) Reactive/Apparent /Active (for 4W only)

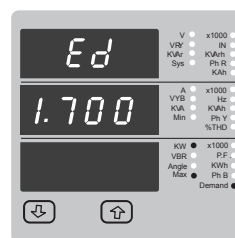

Screen 27: Max Export kW Demand

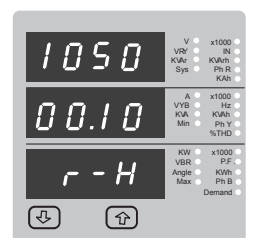

Screen 28: Run Hour

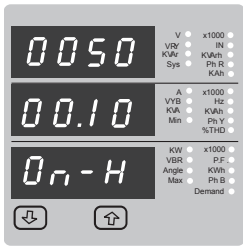

Screen 29: On Hour

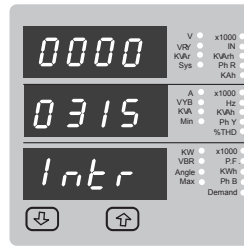

Screen 30: Number of Interruptions

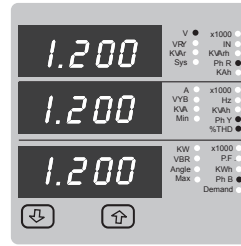

Screen 32a: Voltage %THD
(for 4 wire only)

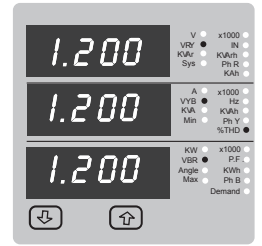

Screen 32b: (for 3 wire only)

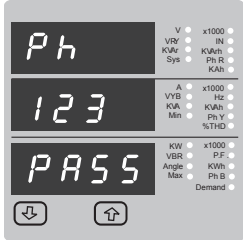

Screen 31a: Correct Phase sequence

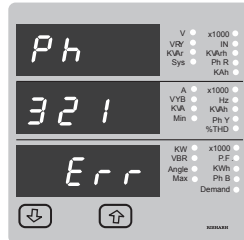

Screen 31b: Phase sequence error

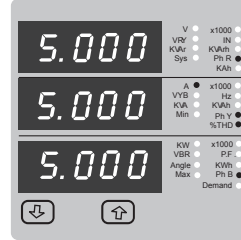

Screen 33: Current %THD

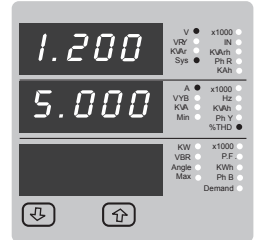

Screen 34: System Voltage & System Current %THD

Setup Parameter Screen

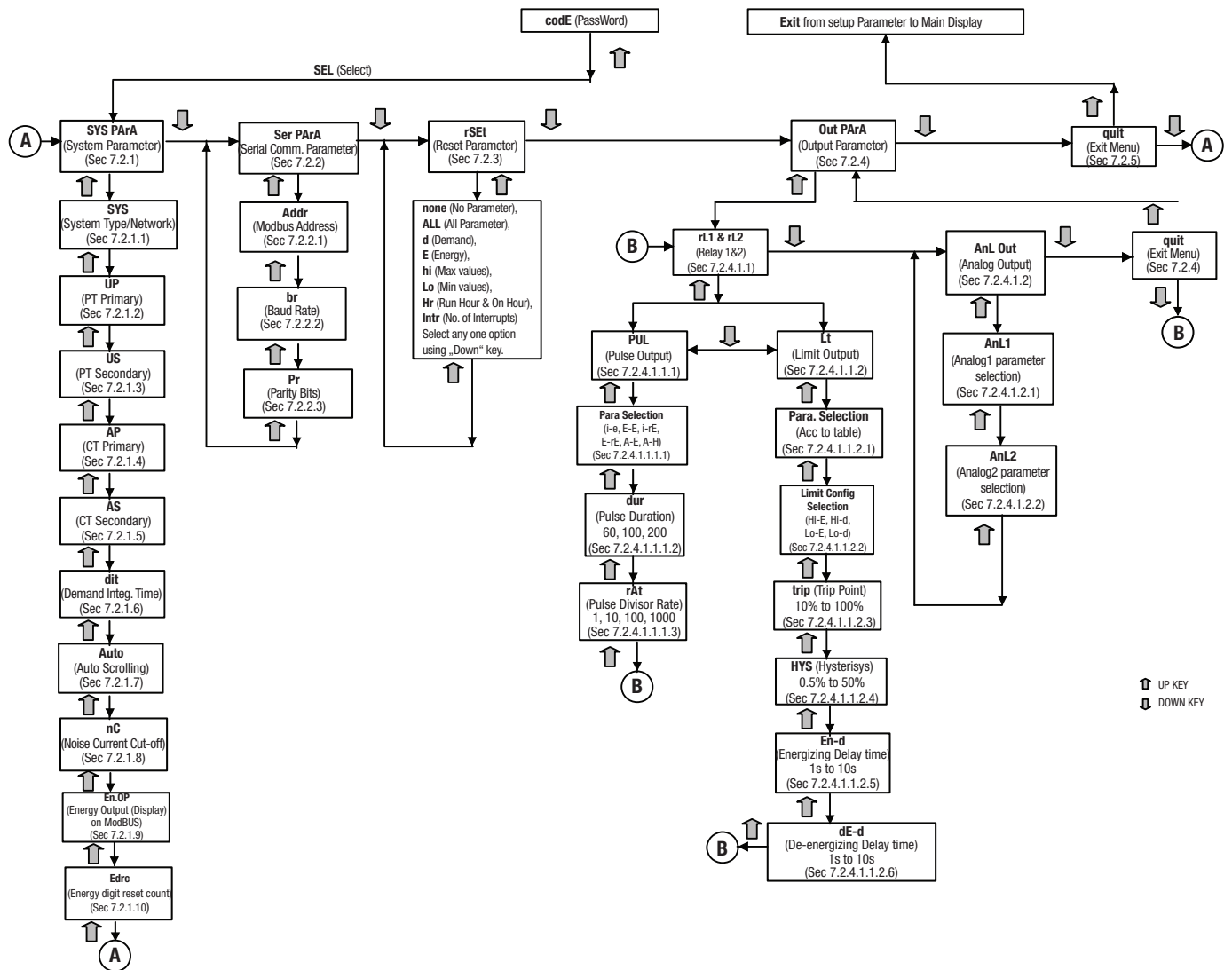

7. Programming

The following sections comprise step by step procedures for configuring the BM1400 for individual user requirements.

To access the set-up screens press and hold the “Down” and “Up” key simultaneously for 5 seconds. This will take the User into the Password Protection Entry Stage (Section 7.1).

7.1. Password Protection

Password protection can be enabled to prevent unauthorised access to set-up screens, by default password protection is not enabled.

Password protection is enabled by selecting a four digit number other than 0000, setting a password of 0000 disables the password protection.

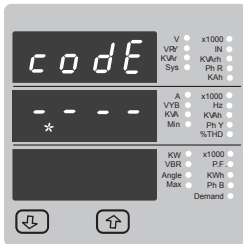

Enter Password, prompt for first digit. (* Denotes that decimal point will be flashing).

Press the “Down” key to scroll the value of the first digit from 0 through to 9, the value will wrap from 9 round to 0.

Press the “Up” key to advance to next digit. In the special case where the Password is “0000” pressing the “Up” key when prompted for the first digit will advance to the “Password Confirmed” screen.

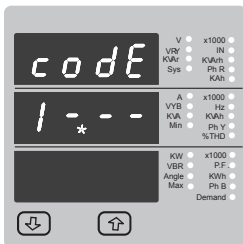

Enter Password, first digit entered, prompt for second digit. (* Denotes that decimal point will be flashing).

Use the “Down” key to scroll the value of the second digit from 0 through to 9, the value will wrap from 9 round to 0.

Press the “Up” key to advance to next digit.

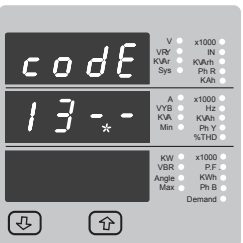

Enter Password, second digit entered, prompt for third digit. (* Denotes that decimal point will be flashing).

Use the “Down” key to scroll the value of the third digit from 0 through to 9, the value will wrap from 9 round to 0.

Press the “Up” key to advance to next digit.

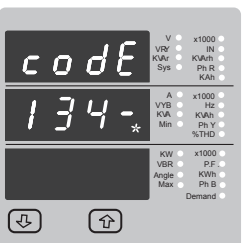

Enter Password, third digit entered, prompt for fourth digit. (* Denotes that decimal point will be flashing).

Use the “Down” key to scroll the value of the fourth digit from 0 through to 9, the value will wrap from 9 round to 0.

Press the “Up” key to advance to verification of the password.

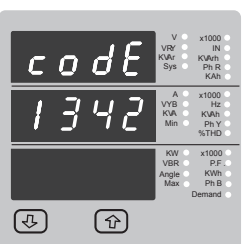

Enter Password, fourth digit entered, awaiting verification of the password.

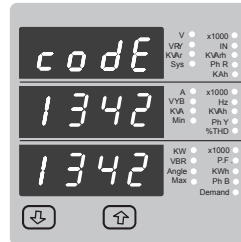

Password confirmed.

Pressing “Down” key will advance to the “New / change Password” entry stage.

Pressing the “Up” key will advance to the Menu selection screen. (See section 7.2).

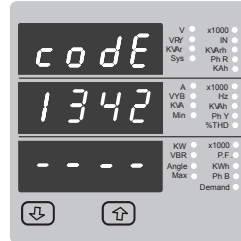

Password Incorrect.

The unit has not accepted the Password entered.

Pressing the “Down” key will return to the Enter Password stage.

Pressing the “Up” key exits the Password menu and returns operation to the measurement reading mode.

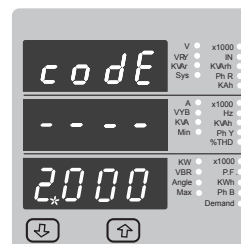

New / Change Password

(*Decimal point indicates that this will be flashing).

Pressing the “Down” key will scroll the value of the first digit from 0 through to 9, the value will wrap from 9 round to 0.

Pressing the “Up” key to advance the operation to the next digit and sets the first digit, in this case to “2”

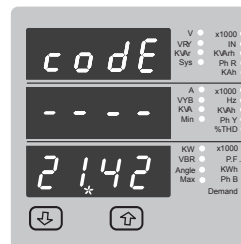

New / Change Password, first digit entered, prompting for second digit. (*Decimal point indicates that this will be flashing).

Pressing the “Down” key will scroll the value of the second digit from 0 through to 9, the value will wrap from 9 round to 0.

Pressing the “Up” key to advance the operation to the next digit and sets the second digit, in this case to “1”

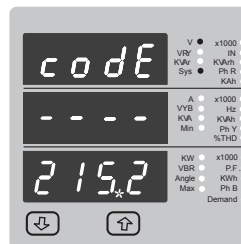

New / Change Password, second digit entered, prompting for third digit. (*decimal point indicates that this will be flashing).

Pressing the “Down” key will scroll the value of the third digit from 0 through to 9, the value will wrap from 9 round to 0.

Pressing the “Up” key to advance the operation to the next digit and sets the third digit, in this case to “5”

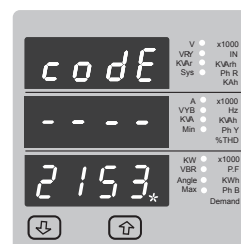

New / Change Password, third digit entered, prompting for fourth digit. (* denotes that decimal point will be flashing).

Pressing the “Down” key will scroll the value of the fourth digit from 0 through to 9, the value will wrap from 9 round to 0.

Pressing the “Up” key to advance the operation to the “New Password Confirmed” and sets the fourth digit, in this case to “3”.

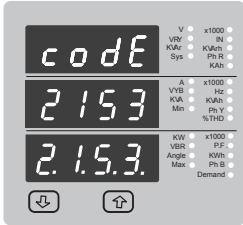

New Password confirmed.

Pressing the “**Down**” key will return to the “New/Change Password”.

Pressing the “**Up**” key will advance to the Menu selection screen.(see section 7.2).

7.2 Menu selection.

7.2.1 System Parameter selection screen.

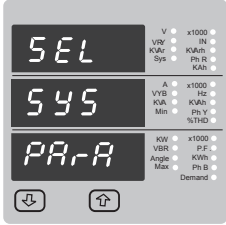

This screen is used to select the different system Parameter like “system type,”“CT Ratio”“PT Ratio”, Pressing the “**Up**” key allows the user to set Different system parameters. (see section 7.2.1.1 to 7.2.1.8)

Pressing the “**Down**” key will advance to Communication selection screen (see section 7.2.2)

7.2.2 Communication Parameter selection screen.

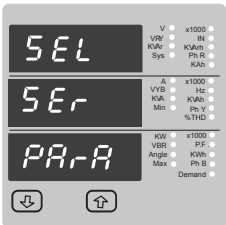

This screen is used to select the different communication parameters like “Address selection,”“RS485 Parity selection”, “RS485 baud rate”

Pressing the “**Up**” key allows the user to set different Communication parameters (see section 7.2.2.1 to 7.2.2.3)

Pressing the “**Down**” key will advance to Reset parameter Screen. (see section 7.2.3)

7.2.3 Reset Parameter selection screen.

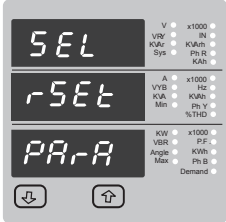

This screen is used to Reset the different parameters.

Pressing the “**Up**” key allows the user to Reset different system parameters (see section 7.2.3.1)

Pressing the “**Down**” key will advance to Output option selection screen (see section 7.2.4).

7.2.4 Output Option selection screen.

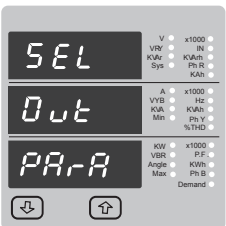

This screen will allow the user to select different Output options Like “Relay1”, “Relay2”, “Analog” Output.

Pressing the “**Up**” key allows the user to select & Configure the output option (see section 7.2.4.1)

Pressing the “**Down**” key will advance to Quit screen. (see section 7.2.5)

7.2.5 Quit screen.

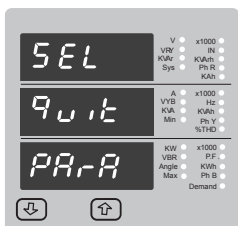

This screen will allow the user to Quit the Menu.

Pressing the “**Up**” key will allow the user to Quit from menu & return to measurement screen.

Pressing the “**Down**” key will advance to system Parameter selection screen. (see section 7.2.1)

7.2.1 System Parameters selection.

7.2.1.1 System type.

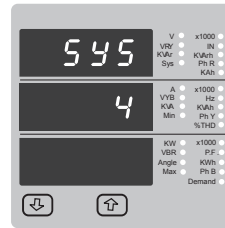

This screen is used to set the system type.

System type “3” for 3 phase 3 wire & “4” for 3 phase 4 wire system.

Pressing the “**Up**” key accepts the present value and advances to the “Potential transformer primary value Edit” menu (see section 7.2.1.2)

Pressing the “**Down**” key will enter the system type edit mode and scroll the values through values available .Pressing the “**Up**” key advances to the system type confirmation menu.

System type confirmation

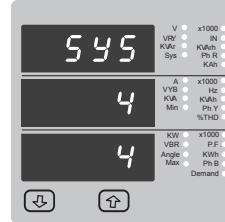

This screen will only appear following the edit of system type. If system type is to be Downed again.

Pressing the “**Up**” key sets the displayed value and will advance to “Potential Transformer Primary Value Edit” menu. (See section 7.2.1.2)

Pressing the “**Down**” key will return to the system type edit stage by blanking the bottom line of the display .

7.2.1.2 Potential Transformer Primary Value

The nominal full scale voltage which will be displayed as the Line to Line voltages for all system types. The values displayed represent the voltage in kilovolts (note the x1000 enunciator).

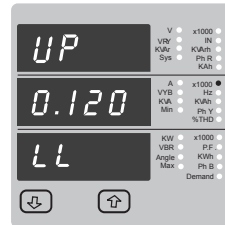

Pressing the “**Up**” key accepts the present value and advances to the “potential Transformer secondary Value edit” menu. (See Section 7.2.1.3)

Pressing the “**Down**” key will enter the “Potential Transformer Primary Value Edit” mode.

Initially the “multiplier must be selected, pressing the “**Down**” key will move the decimal point position to the right until it reaches ###.# after which it will return to #.##.#.

Pressing the “**Up**” key accepts the present multiplier (decimal point position) and advances to the “potential Transformer primary Digit Edit” mode.

Potential Transformer primary Digit Edit

Pressing the “**Down**” key will scroll the value of the most significant digit from 0 through to 9 unless the presently displayed Potential Transformer Primary Value together with the Current Transformer Primary Value, previously set, would result in a maximum power of greater than 666.6 MVA per phase in which case the digit range will be restricted.

Pressing the “**Up**” key accepts the present value at the cursor position and advances the cursor to the next less significant digit.

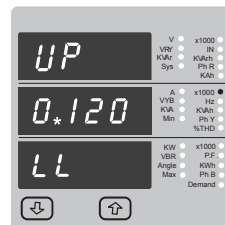

The PT Primary value can be set from 100V L-L to 692.8 kV L-L.

Note : the flashing decimal point indicates the cursor position, a steady decimal point will be present to identify the scaling of the number until the cursor position coincides with the steady decimal point position. At this stage the decimal point will flash.

When the least significant digit has been set pressing the “**Up**” key will advance to the

“Potential Transformer Primary Value Confirmation” stage.

Screen showing display of 0.120 kV i.e. 120 Volts indicating steady decimal point and cursor flashing at the “hundreds of volts” position.

Potential Transformer Primary Value Confirmation

This screen will only appear following an edit of the Potential Transformer Primary Value.

If the scaling is not correct, pressing the “**Down**” key will return to the “Potential Transformer Primary Value Edit” stage.

Pressing the “**Up**” key sets the displayed value and will advance to the Potential Transformer secondary Value (See Section 7.2.1.3)

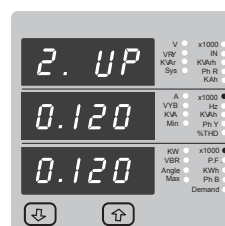

Note: 0.120 kV i.e. 120 V_{LL}

7.2.1.3 Potential Transformer secondary Value

The value must be set to the nominal full scale secondary voltage which will be obtained from the Transformer when the potential transformer(PT)primary is supplied with the voltage defined in 7.2.1.2 potential transformer primary voltage. The ratio of full scale primary to full scale secondary is defined as the transformer ratio.

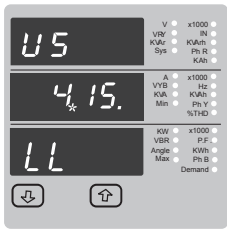

Pressing the "Up" key accepts the present value and advances to the "Current Transformer Primary Value Edit" menu. (See Section 7.2.1.4)

Note that the range of instrument is from 240 to 480V for 415 VL-L. Please refer the table below for different ranges.

Pressing the "Down" key will enter the "Potential Transformer Secondary Value Edit" mode. "Down" key will scroll the value of the most significant

digit From available range of PT secondary value

Pressing the "Up" key accepts the present value at the cursor position and advances the cursor to the next less significant digit.

Potential Transformer secondary ranges for various Input Voltages

110V L-L (63.5V L-N)	100 - 120V L-L (57.73V - 69.28V L-N)
230V L-L (133.0V L-N)	121 - 239V L-L (69.68V - 138V L-N)
440V L-L (239.6V L-N)	240 - 480V L-L (138.56 - 277.12V L-N)

Note: the flashing decimal point indicates the cursor position, a steady decimal point will be present to identify the scaling of the number until the cursor position coincides with the steady decimal point position. At this stage the decimal point will flash.

When the least significant digit has been set pressing the "Up" key will advance to the "Potential Transformer secondary Value Confirmation" stage.

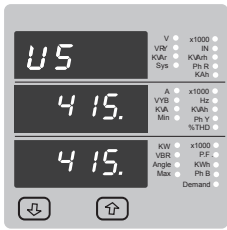

Potential Transformer Secondary Value Confirmation This screen will only appear following an edit of the Potential Transformer Secondary Value.

If the scaling is not correct, pressing the "Down" key will return to the "Potential Transformer Secondary Value Edit"

Pressing the "Up" key sets the displayed value and will advance to the current Transformer Primary Value (See Section 7.2.1.4)

7.2.1.4 Current Transformer Primary Value

The nominal Full Scale Current that will be displayed as the Line currents. This screen enables the user to display the Line currents inclusive of any transformer ratios, the values displayed represent the Current in Amps.

Pressing the "Up" key accepts the present value and advances to the Current Transformer Secondary Value (See Section 7.2.1.5)

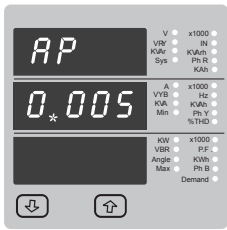

Pressing the "Down" key will enter the "Current Transformer Primary Value Edit" mode. This will scroll the value of the most significant digit from 0 through to 9, unless the presently displayed Current Transformer Primary Value together with the Potential Transformer Primary Value results in a maximum power of greater than 666.6 MVA in which case the digit range will be restricted, the value will wrap. Example: If primary value of PT is set as 692.8kV

L-L (max value) then primary value of Current is restricted to 1157A. Pressing the "Up" key will advance to the next less significant digit. (* Denotes that decimal point will be flashing).

The "Maximum Power" restriction of 666.6 MVA refers to 120% of nominal current and 120% of nominal voltage, i.e, 462.96 MVA nominal power per phase.

When the least significant digit had been set, pressing the "Up" key will advance to the "Current Transformer Primary Value Confirmation" stage.

The minimum value allowed is 1, the value will be forced to 1 if the display contains zero when the "Up" key is pressed.

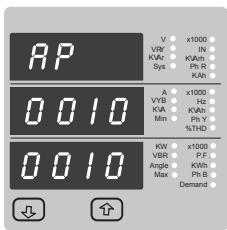

Current Transformer Primary Value Confirmation.

This screen will only appear following an edit of the Current Transformer Primary Value.

If the scaling is not correct, Pressing the "Down" key will return to the "Current Transformer Primary Value Edit" stage with the most significant digit highlighted (associated decimal point flashing) and the bottom line of the display will be blanked.

Pressing the "Up" key sets the displayed value

and will advance to the "Current Transformer Secondary Value Edit" menu. (See Section 7.2.1.5)

7.2.1.5 Current Transformer Secondary Value

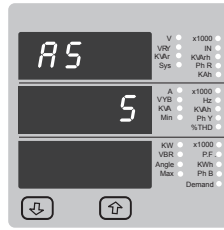

This screen is used to set the secondary value for Current Transformer. Secondary value "5" for 5A or "1" for 1A can be selected. Pressing the "Up" key accepts the present value and advances to the Demand integration Time (See Section 7.2.1.6)

Pressing the "Down" key will enter the CT Secondary value edit mode and scroll the value through the values available.

Pressing the "Up" key will advance to the CT Secondary value confirmation.

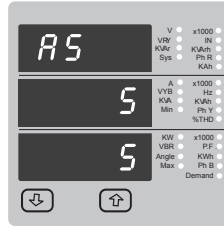

CT Secondary value confirmation

This screen will only appears following an edit of CT secondary value .

If secondary value shown is not correct, pressing the Down key will return to CT secondary edit stage by blanking the bottom line of the display.

Pressing "Up" key sets the displayed value and will advance to Demand integration Time Edit menu. (See Section 7.2.1.6)

7.2.1.6 Demand Integration Time

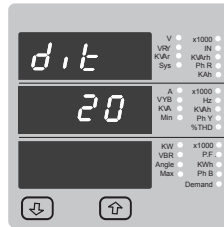

This screen is used to set the period over which current and power readings are to be integrated The Unit of displayed Readings is minutes.

Pressing the "Down" key will scroll through the Following Options 8,15,20,30.

Pressing the "Up" key will advance to Demand Integration confirmation screen.

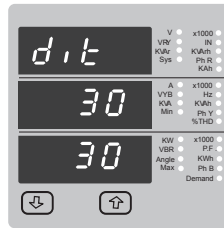

Demand Integration Time value confirmation

Pressing "Up" key sets the displayed value and will advance to scroll screen. (See Section 7.2.1.7)

7.2.1.7 Auto Scrolling

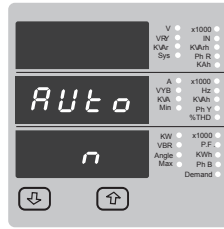

This screen allows user to enable screen scrolling. Auto scrolling Edit.

Pressing "Up" key accepts the present status and advance to the Low Current noise cutoff (See Section 7.2.1.8).

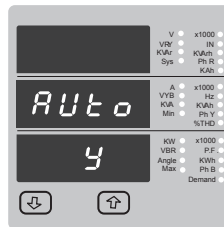

Pressing the "Down" key will enter the "Auto Screen Scrolling Edit" and toggle the status 'Yes' and 'No'.

Pressing the "Up" key will select the status displayed and advance to the Low Current noise cutoff (See Section 7.2.1.8)

7.2.1.8 Low Current noise cutoff.

This screen allows the user to set Low noise current cutoff in mA.

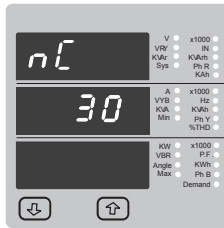

Low current cutoff Edit.

Pressing "Up" key accepts the present value and advance to Energy output Selection. (See section 7.2.1.9)

Pressing the "Down" key will enter the "Low current noise cutoff Edit" mode and scroll the "Value" through 0 & 30 and wrapping back to 0. Setting 30 will display measured currents as 0 below 30 mA.

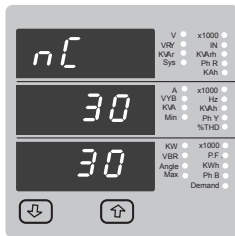

Low current noise cutoff Confirmation.
pressing the “**Down**” key will re-enter the “Low current Noise cutoff Edit” mode.

Pressing “**Up**” key set displayed value and Advance to the energy output selection (See section 7.2.1.9)

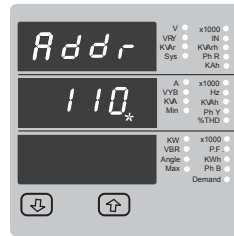

Enter Address, second digit entered, prompt for third digit (* Denotes that decimal point will be flashing).

Use the “**Down**” key to scroll the value of the third digit.

7.2.1.9. Energy Display on modbus

This screen enable user to set energy in terms of Wh / KWh / MWh on RS 485 Output depending as per the requirement. Same applicable for all types of energy.

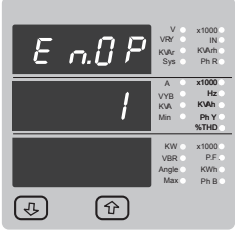

Pressing “**Up**” key accepts the presents value and advances to the “Energy digit reset count” menu (See section 7.2.1.10).

Pressing the “**Down**” key will enter the “Energy Display On Modbus Edit” mode and scroll the value through the values 1,2 & 3 wrapping back to 1

- 1: Energy In Wh
- 2: Energy in KWh
- 3: Energy in MWh

Pressing the “**Up**” key advances to the “Energy Display On Modbus Confirmation” menu.

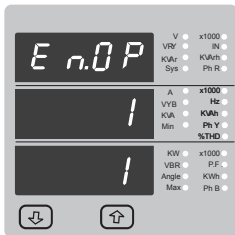

Energy Display On Modbus Confirmation.

This screen will only appear following an edit of the Energy Display On Modbus.

Pressing the “**Down**” key will enter the “Energy Display On Modbus Edit” stage by blanking the bottom line of the display.

Pressing “**Up**” key sets the displayed value and will advance to the “Energy digit reset count” menu. (See section 7.2.1.10)

Note: Default value is set to '1' i.e. Energy on Modbus will be in terms of Wh/VArh/VAh/Ah resp.

7.2.1.10 Energy Digit reset count:

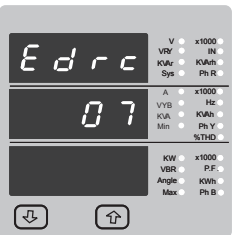

This screen enables user for setting maximum energy count after which energy will rollback to zero depends upon setting of Wh,KWh, & MWh.

Pressing the “**Up**” key sets the displayed value and will jump back to the system parameter selection (See Section 7.2.1)

Pressing the “**Down**” key will enter the Energy digit reset count edit mode. This will scroll the value of reset count from 7 to 14 for Wh, **from 7 to 12**

for KWh & from 7 to 9 for MWh.

Ex. If energy display on modbus is set Wh & It will set Energy digit count to 10 then energy will reset after “9,999,999,999” & then will rollback to zero.

Pressing “**Up**” key “ will advance to Energy digit reset count confirmation screen.

Pressing the “**Down**” key will re-enter Energy digit reset count edit mode.

Pressing the “**Up**” key sets the displayed value and will jump back to the system parameter selection (See Section 7.2.1)

- Note: 1) Default value is set to “14” i.e if energy count crosses 14 digit it will rollback to zero.
2) Energy displays on modbus is set to (2) & energy digit reset count is set to 12. Energy screen on display will show “-----” i.e Energy overflow .when energy crosses the 11 digit count.
3) Energy displays on modbus is set to (3) & energy digit reset count is set to 9. Energy screen on display will show “-----” i.e Energy overflow .when energy crosses the 8 digit count.

7.2.2 Communication Parameter Selection:

7.2.2.1 Address Setting:

This screen applies to the RS 485 output only. This screen allows the user to set Rs485 parameter for instruments

The range of allowable address is 1 to 247.

Enter Address, prompt for first digit.
(* Denotes that decimal point will be flashing).

Press the “**Down**” key to scroll the value of the first digit.

Press the “**Up**” key to advance to next digit.

Enter Address, first digit entered, prompt for second digit (* Denotes that decimal point will be flashing).

Use the “**Down**” key to scroll the value of the second digit

Press the “**Up**” key to advance to next digit.

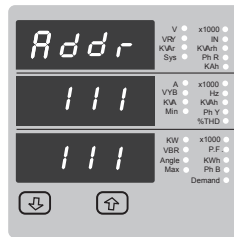
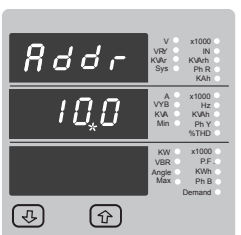
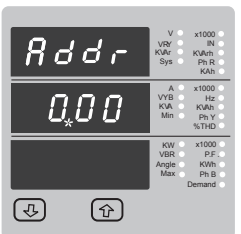

Address confirmation Screen.

This Screen confirms the Address set by user.

Press the “**Up**” key to advance to next Screen “Rs485 Baud Rate” (See Section 7.2.2.2)

Pressing the “**Down**” key will reenter the “Address Edit” mode.

7.2.2.2 RS 485 Baud Rate

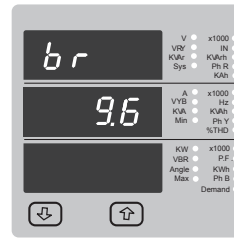

This screen allows the user to set Baud Rate of RS 485 port. The values displayed on screen are in kbaud.

Pressing “**Up**” key accepts the present value and advance to the Parity Selection (See Section 7.2.2.3)

Pressing the “**Down**” key will enter the “Baud Rate Edit” mode and scroll the value through 2.4, 4.8, 9.6 , 19.2 and back to 2.4

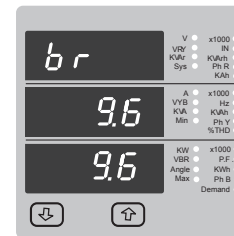

RS 485 Baud Rate confirmation:

Pressing “**Down**” key will be re-enter into the Baud Rate Edit mode.

Pressing the “**Up**” key will select the value and advances to the Parity Selection (See Section 7.2.2.3).

7.2.2.3 RS 485 Parity Selection

This screen allows the user to set Parity & number of stop bits of RS 485 port.

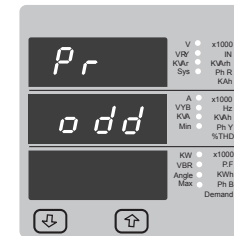

Pressing “**Up**” key accepts the present value and advance to Menu selection (see section 7.2).

Pressing the “**Down**” key will enter the “Parity & stop bit Edit” mode and scroll the value through

- odd: odd parity with one stop bit
- no 1 : no parity with one stop bit
- no 2 : no parity with two stop bit
- E : even parity with one stop bit

RS 485 Parity confirmation:

Pressing “**Down**” key will be re-enter into Parity Edit mode.

Pressing the “**Up**” key will set the value.

Pressing the “**Up**” key again will jump back to the communication parameter selection menu (see section 7.2.2).

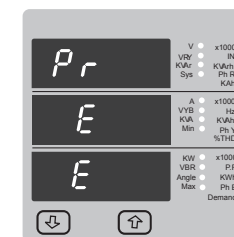

7.2.3 Reset Parameter Selection

7.2.3.1 Resetting Parameter

The following screens allow the users to reset the all Energy , Lo(Min), hi(Max), Demand, Run hour , On hour, No.of Interrupts

Reset (Note)

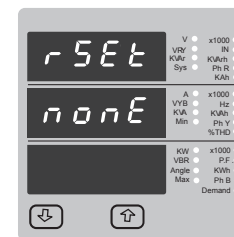

Pressing “**Up**” key advances to Reset Parameter selection screen (see section 7.2.3)

Pressing the “**Down**” key will enter the “Reset option” mode and scroll through Parameter and wrapping back to None.

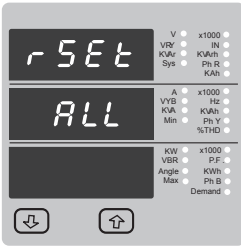

Reset option select, (Resets ALL resettable parameter)

The user has scrolled through to the "ALL".

Pressing "Up" key will select the value and advance to the "Reset ALL Confirmation" Mode & Will reset all resettable parameter.

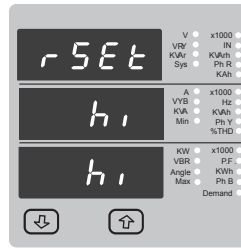

Reset hi (Max) Confirmation.

Pressing the "Down" key will re-enter the "Reset option Select mode."

Pressing "Up" key will jump back to the Reset Parameter selection screen (see section 7.2.3).

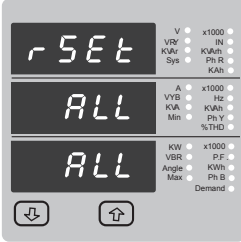

Reset ALL Confirmation.

Pressing the "Down" key will re-enter the Reset option Select mode.

Pressing "Up" key will jump back to the Reset Parameter selection screen (see section 7.2.3).

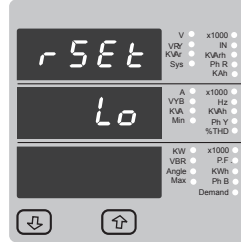

Reset option select, (Reset Lo)

The user has scrolled through to the "Lo" (Min)

Pressing "Up" key will select the value and advance to the "Reset Lo Confirmation" Mode & Will reset minimum values of Voltage & Current Avg. appeared at Input.

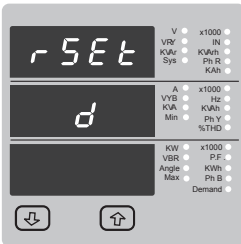

Reset option select, (Reset A Demand, KVA Demand Parameters KW demand (Import/Export))

The user has scrolled through to the "d".

Pressing "Up" key will select the value and resets all Demand parameters.

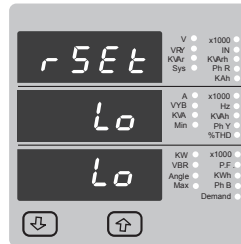

Reset Lo Confirmation

Pressing the "Down" key will re-enter the "Reset option Select mode."

Pressing "Up" key will jump back to the Reset Parameter selection screen (see section 7.2.3).

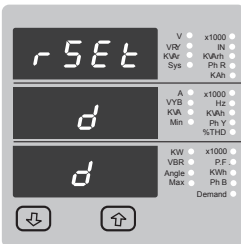

Reset Demand parameters Confirmation.

Pressing the "Down" key will re-enter the "Reset option Select mode."

Pressing "Up" key will jump back to the Reset Parameter selection screen (see section 7.2.3).

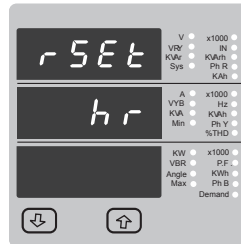

Reset option select, hr (ON Hour & Run Hour)

The user has scrolled through to the "hr"

Pressing "Up" key will select the value and advance to the "Reset hr Confirmation" Mode & Will reset On hour & Run Hour both.

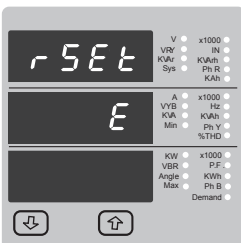

Reset option select, (Resets all Energies)

The user has scrolled through to the "E" Energy value.

Pressing "Up" key will select the value and advance to the "Reset Energy Confirmation" Mode. & resets all Energies (Import Energy, Export Energy Import reactive, Export reactive, Apparent Energy Ampere Hour)

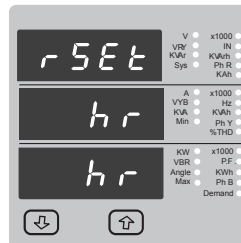

Reset hr Confirmation

Pressing the "Down" key will re-enter the "Reset option Select mode."

Pressing "Up" key will jump back to the Reset Parameter selection screen (see section 7.2.3).

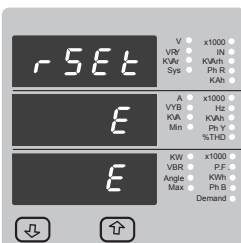

Reset Energy Confirmation.

Pressing the "Down" key will re-enter the "Reset option" mode.

Pressing "Up" key will jump back to the Reset Parameter selection screen (see section 7.2.3).

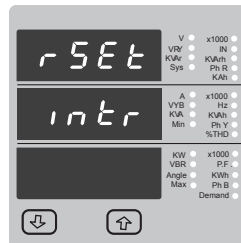

Reset option select, (Reset Number of Interrupt)

The user has scrolled through to the "intr"

Pressing "Up" key will select the value and advance to the "reset Interrupt Confirmation" Mode & Will reset number of Auxiliary supply interruption count.

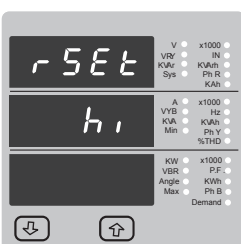

Reset option select, (Reset Hi)

The user has scrolled through to the "Hi" (Max)

Pressing "Down" key will select the value and Pressing "Up" key will select the value and advance to the "Reset Hi Confirmation" Mode. advance to the "Reset Hi Confirmation" Mode &

Will reset Maximum (Hi) values of Voltage & Current Avg. appeared at input.

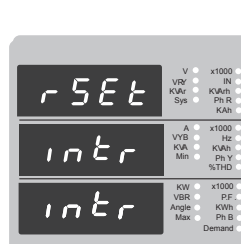

Reset Interrupt Confirmation

Pressing the "Down" key will re-enter the "Reset parameter Selection"(see section 7.2.3).

Pressing "Up" key will jump back to the Reset Parameter selection screen (see section 7.2.3).

7.2.4. Output Option selection menu

7.2.4.1 Configuration of Output

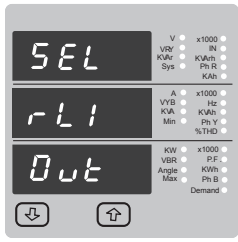

This screen applies to the Relay1 Output option Selection.

Pressing “Up” key will select the

Relay1 output selection menu (See section 7.2.4.1.1) pressing the “Down” key will advance

Relay2 output option below.

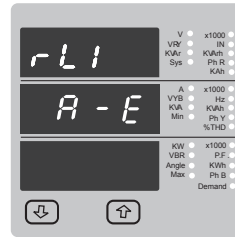

Pressing “Up” key accepts the present setting and advance to “Pulse duration selection” (see section 7.2.4.1.1.1.2).

Pressing the “Down” key will enter into edit mode and scroll through the energy setting

- A - E:** Apparent Energy
- I - E:** Import Energy (Active)
- E - E:** Export Energy (Active)
- I - rE:** Import Reactive Energy
- E - rE:** Export Reactive Energy
- A - H:** Ampere Hour

Pulse output (for Relay 1) confirmation:

Pressing “Down” key will be re-enter into edit mode.

Pressing the “Up” key will set the value and advances to the “Pulse duration selection” (see section 7.2.4.1.1.1.2).

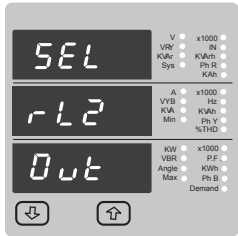

This screen applies to the Relay2 Output option Selection.

Pressing “Up” key will advance to the select

Relay 2 output selection menu. (See section 7.2.4.1.2)

pressing the “Down” key will advance to

Analog output option below.

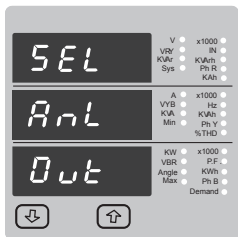
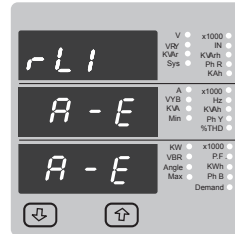

This screen applies to the Analog Output Selection. Pressing “Up” key will Select the Analog output selection menu (See section 7.2.4.3)

Pressing the “Down” key will advance to Quit screen.

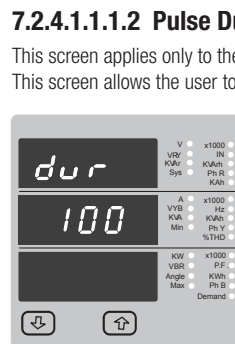

7.2.4.1.1.2 Pulse Duration Selection:

This screen applies only to the Pulsed output mode of both the relay.

This screen allows the user to set Relay energisation time in milliseconds.

Pulse Duration Edit.

Pressing “Up” key accepts the present value and advance to pulse rate selection menu (see section 7.2.4.1.1.1.3).

Pressing the “Down” key will enter the “Pulse Duration Edit” mode and scroll the value through 60, 100, 200 and wrapping back to 60.

Pressing the “Up” key will select the value and advances to “Pulse Duration Confirmation”.

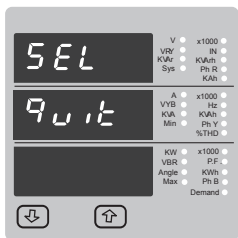

This screen allows the user to quit the output option

Pressing “Up” key will advance to the

Output Parameter selection (See section 7.2.4)

Pressing the “Down” key will go back to Relay1 output option (See section 7.2.4.1).

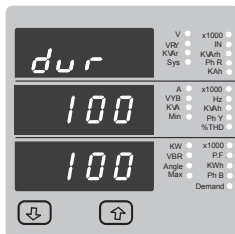

Pulse Duration Confirmation.

This screen will only appear following an edit of the Pulse duration.

Pressing the “Down” key will re-enter the “Pulse Duration Edit” mode.

Pressing “Up” key set displayed value and Will advance to pulse rate selection menu (See section 7.2.4.1.1.1.3)

7.2.4.1.1 Relay1 output Selection menu:

7.2.4.1.1.1 Pulse output:

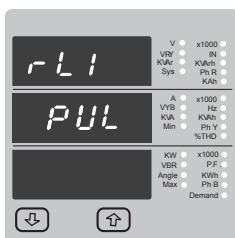

This screen is used to assign Relay1 in Pulse output mode

Pressing “Up” key will advance to the

Pulse (for Relay1) output configuration (See section 7.2.4.1.1.1.1)

Pressing “Down” key will show “Limit” output option (See section 7.2.4.1.1.2)

7.2.4.1.1.3 Pulse Rate

This screen applies to the Relay Output option only. The screen allows user to set the energy pulse rate divisor. Divisor values can be selected through 1,10,100,1000 in Wh.

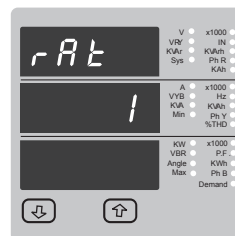

Pressing “Up” key accepts the presents value and advances to the “Configuration of Output” (See section 7.2.4.1).

Pressing the “Down” key will enter the “Pulse rate divisor Edit” mode and scroll the value through the values 1,10,100, 1000 wrapping back to 1 in Wh but in KWh & MWh pulse rate divisor is only 1 ..

Pressing the “Up” key advances to the “Pulse rate Divisor Confirmation” menu.

For setting divisor value refer table 3.

7.2.4.1.1.2 Limit output :

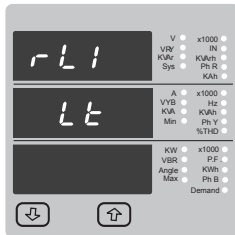

This screen is used to assign Relay1 in limit output mode.

Pressing “Up” key will assign

Limit (for Relay1) output mode.(See section 7.2.4.1.1.2.1)

Pressing “Down” key will go back to the pulse option (For Relay 1) screen.(See section 7.2.4.1.1.1)

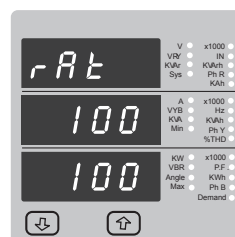

Pulse Rate Divisor Confirmation.

This screen will only appear following an edit of the Pulse rate divisor.

If the Pulse rate shown is not correct, pressing the “Down” key will return to the “Pulse rate divisor Edit” stage by blanking the bottom line of the display. Pressing “Up” key sets the displayed value and will advance to the “Configuration of output”. (See section 7.2.4.1)

7.2.4.1.1.2.1 Assignment of Limit output (for Relay1) to parameter.

This screen is for Limit output mode selection. It allows the user to set Limit output corresponding measured value. Refer Table 2 "Parameter for Analog & Limit output" for assignment.

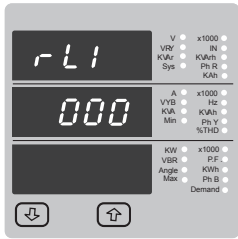

Pressing the "Up" key accepts the present value and advance to the Limit1 configuration select screen. (see section 7.2.4.1.1.2.2).

Pressing the "Down" key will enter the "Limit1 output Edit" mode and scroll the values, as per Table 2, "Parameter for Analog & Limit Output"

Pressing the "Up" key advance to the Limit1 output confirmation screen.

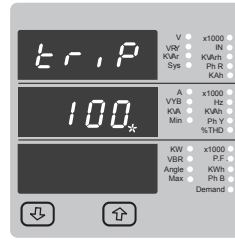

The second digit entered, prompt for third digit (* Denotes that decimal point will be flashing).

Use the "Down" key to scroll the value of the third digit

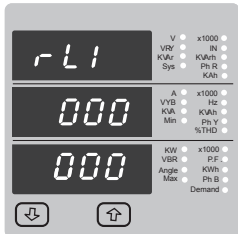

Limit1 output Confirmation:

Pressing the "Down" key will re-enter the "Limit1 output Edit"

Pressing the "Up" key sets the displayed value and will advance to the Limit1 Configuration select screen.

(see section 7.2.4.1.1.2.2)

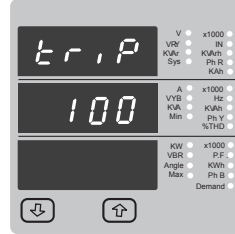

Entered the value for third digit.

Press the "Up" key to advance to trip point confirmation Screen.

7.2.4.1.1.2.2 Limit1 Configuration select

This screen is used to set the Limit1 Configuration, four different types of configuration can be selected.

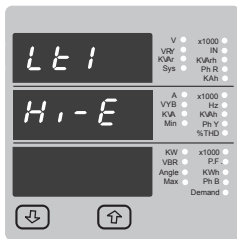

- H i - E (High Alarm & Energized Relay)
- H i - d (High Alarm & De-Energized Relay)
- L o - E (Low Alarm & Energized Relay)
- L o - d (Low Alarm & De-Energized Relay)

(For detail refer to section 9.2)

Pressing the "Up" key accepts the present value and advances to the "Trip point selection" screen (see section 7.2.4.1.1.2.3)

Pressing the "Down" key will enter the Limit1 configuration edit mode and scroll through the Modes available .

Pressing the "Up" key advances to the Limit1 configuration type confirmation menu.

Limit1 Configuration Confirmation

This screen will only appear following the edit of system type. If system type is to be changed again, pressing the "Down" key will return to the Limit1 configuration Type edit stage by blanking the bottom line of the display.

Pressing the "Up" key sets the displayed value and will advance to "Trip point selection" Screen (See section 7.2.4.1.1.2.3)

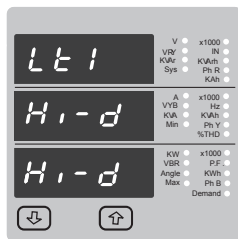

Value confirmation Screen.

This Screen confirms the value set by user.

Press the "Up" key to advance to next Screen "Hysteresis selection" (see section 7.2.4.1.1.2.4)

Pressing the "Down" key will return in edit mode

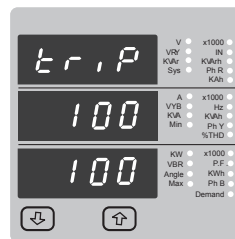

7.2.4.1.1.2.4 Hysteresis selection:

This screen applies to the Hysteresis selection.

This screen allows the user to set Hysteresis for relay1 output. Trip point.

Enter value, prompt for first digit.

(* Denotes that decimal point will be flashing).

Press the "Down" key to scroll the value of the first digit.

Press the "Up" key to advance to next digit.

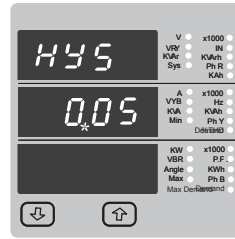

7.2.4.1.1.2.3 Trip point selection:

This screen applies to the Trip point selection.

This screen allows the user to set Trip point for instruments.

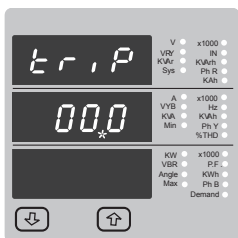

The allowable range is 10% to 120% for High Alarm. The allowable range is 10% to 100% for Low Alarm. Enter value, prompt for first digit.

(* Denotes that decimal point will be flashing).

Press the "Down" key to scroll the values of the first digit.

Press the "Up" key to advance to next digit.

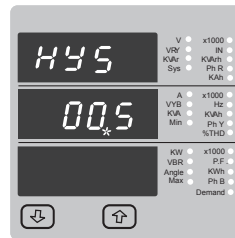

The first digit entered, prompt for second digit (* Denotes that decimal point will be flashing).

Use the "Down" key to scroll the value of the second digit.

Press the "Up" key to advance to next digit.

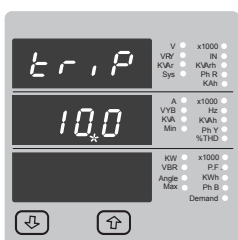

The first digit entered, prompt for second digit (* Denotes that decimal point will be flashing).

Use the "Down" key to scroll the value of the second digit

Press the "Up" key to advance to next digit.

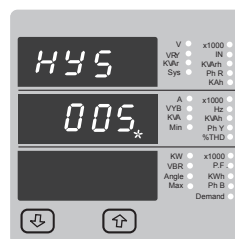

The second digit entered, prompt for third digit (* Denotes that decimal point will be flashing).

Use the "Down" key to scroll the value of the third digit

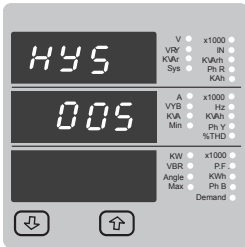

Entered value for third digit.

Press the “**Up**” key to advance to Hysteresis confirmation Screen.

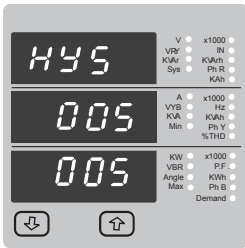

Hysteresis confirmation Screen.

This Screen confirms the percentage value set by user & Screen will appear only after edit mode of Hysteresis.

Press the “**Up**” key to advance to next Screen
“Energizing delay time” (7.2.4.1.1.2.5)

7.2.4.1.1.2.5 Energizing Delay time.

This screen allows the user to set Energizing Delay time for Relay 1 Limit Assigned Parameters.

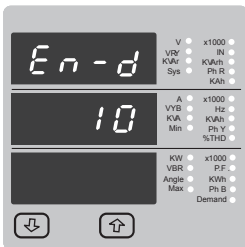

Pressing “**Up**” key accepts the present value and advance to De-energizing delay screen.

Pressing the “**Down**” key will enter the “Energizing Delay” Edit mode and scroll the “Value” through 1 to 10.

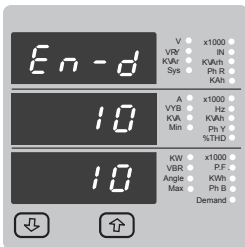

Energizing delay time Confirmation.

This screen will appear only after edit mode of Energizing delay time

pressing the “**Down**” key will re-enter the “Energizing delay Edit” mode.

Pressing “**Up**” key set displayed value and will advance to Assignment of De-energizing delay time. (See section 7.2.4.1.1.2.6)

7.2.4.1.1.2.6 De-Energizing Delay time.

This screen allows the user to set De-Energizing Delay time for Relay 1 Limit Assigned Parameters.

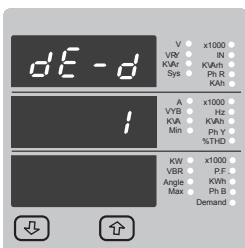

.Pressing “**Up**” key accepts the present value and advance to Configuration of Output. (See section 7.2.4.1)

Pressing the “**Down**” key will enter the “De-Energizing Delay” Edit mode and scroll the “Value” through 1 to 10.

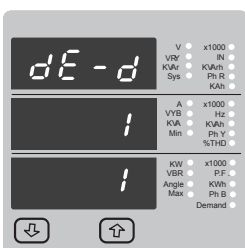

De-Energizing delay time Confirmation.

This screen will appear only after edit mode of De-energizing delay time.

pressing the “**Down**” key will re-enter the “De-energizing delay Edit” mode.

Pressing “**Up**” key set displayed value and will advance to Configuration of Output. (See section 7.2.4.1)

7.2.4.1.2 Analog Output

7.2.4.1.2.1 Parameter setting for Analog Output 1 (Optional)

Configuration of Relay 2 for Pulse or Limit Output is same as Relay 1. If you Select the Pulse output option for Relay 1 same setting will be applicable for Relay 2 except assignment of energy to Pulse output (i.e. Energy assignment of both relay can be different.)

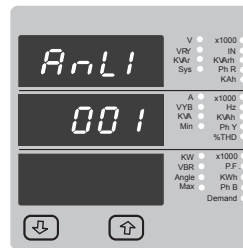

Pressing “**Up**” key accepts the present value and advance to the Analog output 2 selection (see section 7.2.4.1.3.2).

Pressing the “**Down**” key will enter the “Analog output 1 Edit” mode and scroll the values, as per Table 2

“Parameter for Analog & Limit output”

Pressing the “**Up**” key advance to the Analog output 1 confirmation screen.

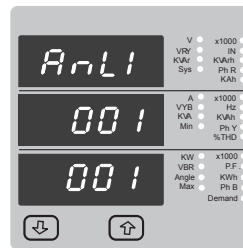

Analog output 1 Confirmation:

This Screen will appear only after edit mode of Analog output 1 Parameter.

Pressing the “**Down**” key will re-enter the “Analog output 1 Edit”

Pressing the “**Up**” key sets the displayed value and will advance to the Analog output 2 selection screen (see section 7.2.4.1.3.2)

7.2.4.1.2.2 Parameter setting Analog Output 2 (Optional)

This screen is for analog output 2 only. It allows the user to set analog output 2 to corresponding measured parameter. Refer table2 “Parameter for Analog & Limit output “

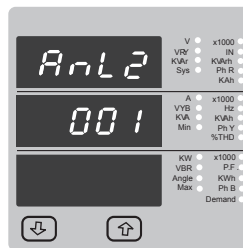

Pressing “**Up**” key accepts the present value and advance to Analog output selection screen (see section 7.2.4.1).

Pressing the “**Down**” key will enter the “Analog output 2 Edit” mode and scroll the values, as per Table 2.“Parameter for Analog output”

Pressing the “**Up**” key advance to the Analog output 2 confirmation screen.

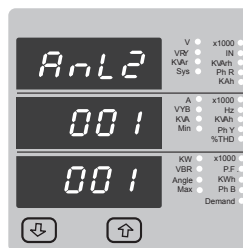

Analog output 2 Confirmation:

This Screen will appear only after edit mode of Analog output 2 Parameter.

Pressing the “**Down**” key will re-enter the “Analog output 2 Edit”

Pressing the “**Up**” key sets the displayed value and will advance to the Analog output selection screen (see section 7.2.4.1).

8. Phase Rotation Error screen:

Meter shows phase rotation error if the phase sequence R-Y-B (L1-L2-L3) is not maintained

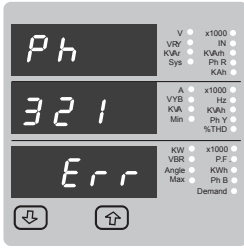

This screen indicates that Phase sequence is incorrect.

User must check this screen in order to get correct readings When meter is connected.

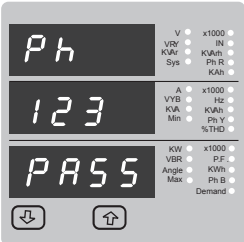

Correct Phase sequence:

This Screen indicates the phase sequence connected to meter is correct. If phase sequence is wrong this screen is useful to get correct phase sequence by interchanging connection & verifying it with screen.

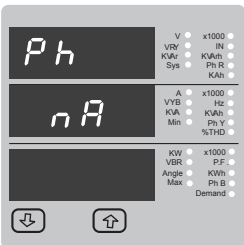

This Screen indicates that all three phases (Voltages) are absent.

9. Run hour:

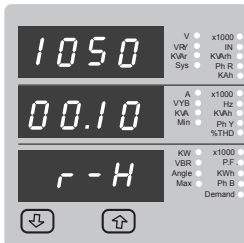

This Screen shows the total no. of hours the load is connected.

Even if the Auxiliary supply is interrupted count of Run hour will be maintained in internal memory & displayed in the format "hours. min". For example if Displayed count is 105000.10 r-H it indicates 105000 hours & 10 minutes.

After 999999.59 run hours display will restart from zero.

To reset run hour manually see section Resetting Parameter 7.2.3.1

10. On hour:

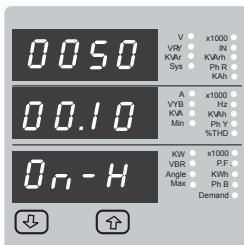

This Screen shows the total no. of hours the Axillary Supply is ON. Even if the Auxiliary supply is interrupted count of On hour will be maintained in internal memory & displayed in the format "hours. min". For example if Displayed count is 005000.10 On-H it indicates 005000 hours & 10 minutes.

After 999999.59 On hours display will restart from zero.

To reset On hour manually see section Resetting Parameter 7.2.3.1

11. Number of Interruption:

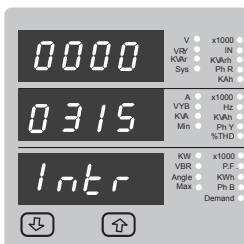

This Screen Displays the total no. of times the Axillary Supply was Interrupted. Even if the Auxiliary supply is interrupted count will be maintained in internal memory.

To reset No of Interruption manually see section Resetting Parameter 7.2.3.1

12. Analog Output (optional):

This module provides two d.c. isolated outputs.

Two 4 - 20mA outputs, internally powered.

On module the output signals are present on pins A1 (Analog Output 1) & A2 (Analog Output 2)

These outputs can be individually assigned to represent any one of the measured and displayed Parameters.

All settlings are user configurable via the user interface screen. See Analog o/p selection (section 7.2.4.1.3) for details.

* Note: Refer diagrams 1

Diagram 1: (4 -20 mA)

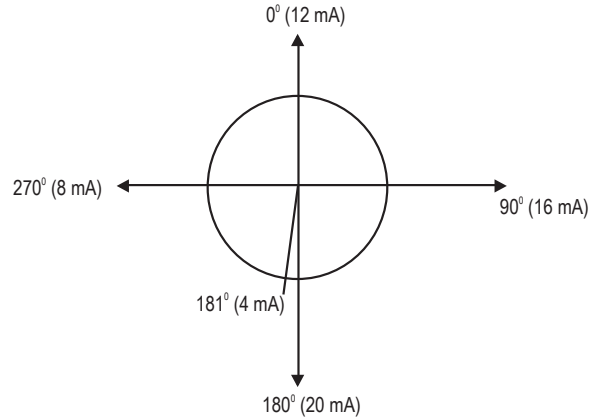

TABLE 2: Parameter for Analog & Limit output

Parameter No.	Parameter	3P 4W	3P 3W	Range
0	None	•	•	–
1	Volts 1	•	•	0 - 100 %
2	Volts 2	•	•	0 - 100 %
3	Volts 3	•	•	0 - 100 %
4	IL1	•	•	0 - 100 %
5	IL2	•	•	0 - 100 %
6	IL3	•	•	0 - 100 %
7	W1	•	x	0 - 120 %
8	W2	•	x	0 - 120 %
9	W3	•	x	0 - 120 %
10	VA1	•	x	0 - 120 %
11	VA2	•	x	0 - 120 %
12	VA3	•	x	0 - 120 %
13	VAR1	•	x	0 - 120 %
14	VAR2	•	x	0 - 120 %
15	VAR3	•	x	0 - 120 %
16	* PF1	•	x	180° / 0 / -180°
17	* PF2	•	x	180° / 0 / -180°
18	* PF3	•	x	180° / 0 / -180°
19	* PA1	•	x	180° / 0 / -180°
20	* PA2	•	x	180° / 0 / -180°
21	* PA3	•	x	180° / 0 / -180°
22	Volts Ave.	•	•	0 - 100 %
24	Current Ave.	•	•	0 - 100 %
27	Watts sum	•	•	10 - 120 %
29	VA sum	•	•	10 - 120 %
31	VAR sum	•	•	10 - 120 %
32	* PF Ave.	•	•	180° / 0 / -180°
34	* PA Ave.	•	•	180° / 0 / -180°
36	Freq.	•	•	10 - 100 % ¹
43	Watt Demand Imp.	•	•	10 - 120 %
44	WATT MAX DEMAND IMP.	•	•	10 - 120 %
45	Watt Demand Exp	•	•	10 - 120 %
46	Watt Demand Max Exp	•	•	10 - 120 %
51	VA DEMAND	•	•	10 - 120 %
52	VA MAX DEMAND	•	•	10 - 120 %
53	CURRENT DEMAND	•	•	10 - 120 %
54	CURRENT MAX DEMAND	•	•	10 - 120 %
101	VRY	•	x	10 - 120 %
102	VYB	•	x	10 - 120 %
103	VBR	•	x	10 - 120 %
113	I Neutral	•	x	10 - 120 %

Note: Parameters 1,2,3 are L-N Voltage for 3P 4W & L-L Voltage for 3P 3W

13. Relay output (Optional):

SIRAX BM1400 is provided with 1 relay for pulse output as well as for limit switch.

13.1 Pulse Output:

Pulse output is the potential free, very fast acting relay contact which can be used to drive an external mechanical counter for energy measurement.

SIRAX BM1400 pulse output can be configured to any of the following parameter through setup parameter screen.

- 1) Active Energy (Import)
- 2) Active Energy (Export)
- 3) Reactive Energy (Import)
- 4) Reactive Energy (Export)
- 5) Apparent Energy
- 6) Ampere hour

TABLE 3: Energy Pulse Rate Divisor

1. For Energy Output in Wh

Divisor	Pulse rate	
	Pulse	System Power *
1	1per Wh	Up to 3600W
	1per kWh	Up to 3600kW
	1per Mwh	Above 3600kW
10	1per 10Wh	Up to 3600W
	1per 10kWh	Up to 3600kW
	1per 10MWh	Above 3600kW
100	1per 100Wh	Up to 3600W
	1per 100kWh	Up to 3600kW
	1per 100MWh	Above 3600kW
1000	1 per 1000Wh	Up to 3600W
	1 per 1000kWh	Up to 3600kW
	1per 1000MWh	Above 3600kW
Pulse Duration 60 ms, 100 ms or 200 ms		

2. For Energy Output in Kwh

Divisor	Pulse rate	
	Pulse	System Power *
1	1per kWh	Up to 3600kW
	1 per 1000kWh	Up to 3600kW
	1per 1000MWh	Above 3600kW

3. For Energy Output in Mwh

Divisor	Pulse rate	
	Pulse	System Power *
1	1 per Mwhr	Up to 3600W
	1 per 1000Mwhr	Up to 3600W
	1 per 1000Gwhr	Above 3600kW

Above options are also applicable for Apparent and Reactive Energy.

* System power = $3 \times CT(\text{Primary}) \times PT(\text{Primary})_{L-N}$ for 3 Phase 4 Wire

System power = $\text{Root}3 \times CT(\text{Primary}) \times PT(\text{Primary})_{L-L}$ for 3 Phase 3 Wire

Ampere Hour:

Divisor 1(Default)

CT secondary = 1A Max pulse rate 3600 pulses per Ah **

CT secondary = 5A Max pulse rate 720 pulses per Ah **

Divisors 10

CT secondary = 1A Max pulse rate 3600 pulses per 10Ah **

CT secondary = 5A Max pulse rate 720 pulses per 10Ah **

Divisors 100

CT secondary = 1A Max pulse rate 3600 pulses per 100Ah **

CT secondary = 5A Max pulse rate 720 pulses per 100Ah **

Divisors 1000

CT secondary = 1A Max pulse rate 3600 pulses per 1000Ah **

CT secondary = 5A Max pulse rate 720 pulses per 1000Ah **

Pulse duration 60 ms, 100 ms or 200 ms

**No. of Pulses per Ampere hour = Maximum Pulses / CT Ratio Where, CT Ratio = (CT primary/ CT Secondary)

13.2 Limit Switch

Limit switch can be used to monitor the measured parameter (Ref.Table:2) in relation with to a set limit.

The limit switch can be configured in one of the four mode given below:

- 1) Hi alarm & Relay Energized Relay.
- 2) Hi alarm & De-Energized Relay.
- 3) Lo alarm & Energized Relay.
- 4) Lo alarm & De-Energized Relay.

Limit switch has user selectable Trip point, Hysteresis, Energizing Delay & De-Energizing delay.

Hi Alarm:

If Hi-Alarm Energized or Hi Alarm De-Energized option is selected then relay will get energized or De-energized,if selected parameter is greater than or equal to trip point.

Low Alarm:

If Lo-Alarm Energized or Lo Alarm De-Energized option is selected then relay will get energized or De-energized,if selected parameter is less than or equal to trip point.

Trip point:

Trip point can be set in the range of 10% to 120 % of nominal value for Hi-Alarm & 10% to 100 % of nominal value for Lo-Alarm.

Hysteresis:

Hysteresis can be set in the range of 0.5% to 50 % of set trip point. If Hi-alarm Energized or Hi-alarm De-energized is selected then relay will get De-energized or Energized respectively, if set parameter value is less than Hysteresis Similarly if Lo-alarm Energized or Lo-alarm De-Energized.

Energizing Delay:

The energizing delay can be set in the range from 1 to 10 sec.

De-Energizing Delay:

The De-energizing delay can be set in the range from 1 to 10 sec.

Note: In case of lo alarm if trip point is set at 100% then maximum 20% Hysteresis can be set.

Example of different configuration.

Parameter No: 4 (Current 1)

Trip Point = 50%

Hysteresis = 50% of trip point

Energising Delay: 2s

De-energising Delay: 2s

1) Hi alarm & Energised relay

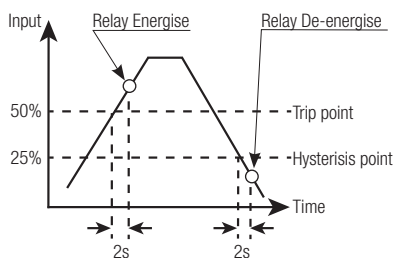

2) Hi alarm & De-energised relay

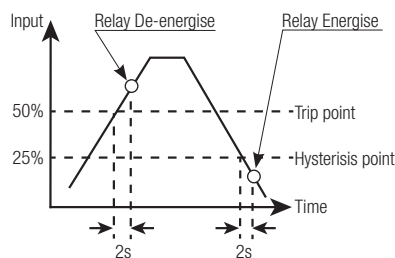

3) Lo alarm & Energised relay

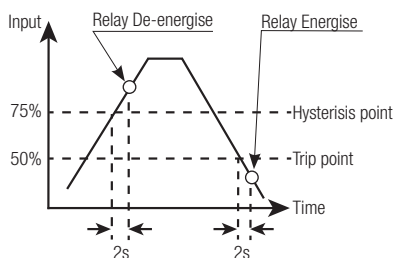

4) Lo alarm & De-energised relay

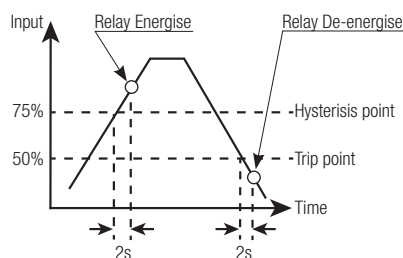

14. Technical data

System

3 Phase 3 Wire / 4 Wire programmable at site: Three wire, three phase system, unbalanced load
Four wire, three phase system, unbalanced load

Inputs

Nominal voltage:

110 V_{L-L} (63,5 VL-N) (Article-No. 176695 / 176702 / 176710)
230 V_{L-L} (133,0 VL-N) (on demand)
440 V_{L-L} (254 VL-N) (Article-No. 174988 / 174996 / 175001)

Max continuous input voltage: 120% of Rated Value
Max short duration input voltage: 2 x Rated Value (1s application repeated 10 times at 10s intervals)
Nominal input voltage burden: 0,2VA approx. per phase
System PT primary value: 100 V_{LL} to 692,8 kV_{LL}

Nominal current:

1A / 5A

Max continuous input current: 120% of Rated Value
Nominal input current burden: 0,6VA approx. per phase
Max short duration current input: 20 x Rated Value (1s application repeated 5 times at 5 min. intervals)
System CT primary values: Std. Values from 1 to 9999A (1 or 5 Amp secondaries)

Auxiliary supply:

100 - 250V AC- DC (45-66Hz)

a.c. supply voltage tolerance: +20 % / -15 % of Rated Value
a.c. supply frequency range: 45 to 66 Hz
a.c. supply burden: 4.5VA
d.c. supply burden: 3W

Operating Measuring Ranges:

Voltage: 5 .. 120 % of Rated Value
Current: 5 .. 120 % of Rated Value
Frequency: 40 .. 70 Hz
Power Factor: 0.5 Lag ... 1 ... 0.8 Lead

Accuracy

Voltage: ± 0.5 % of range
Current: ± 0.5 % of range
Frequency: ± 0.15% of mid frequency
Active Power: ± 0.5 % of range
Re-Active Power: ± 0.5 % of range
Apparent Power: ± 0.5 % of range
Active Energy: ± 0.5 % of range
Re-Active Energy: ± 0.5 % of range
Apparant Energy: ± 0.5 % of range
Power Factor: ± 1 % of Unity
Angle: ± 1 % of range
Analog Output: ± 1 % of Output end value
Total Harmonic Distortion: ± 1 %
Neutral Current: ± 4 % of range

Reference conditions for Accuracy:

Reference temperature:	23 C + 2 C
Input frequency:	50 or 60Hz ± 2%
Input waveform:	Sinusoidal (distortion factor 0.005)
Auxiliary supply voltage:	Rated Value + 1 %
Auxiliary supply frequency:	Rated Value + 1 %
Voltage Range:	50 ... 100% of Nominal Value 60 ... 100% of Nominal Value for THD
Current Range:	10 ... 100% of Nominal Value 20 ... 100% of Nominal Value for THD
Power:	$\cos\emptyset / \sin\emptyset = 1$
Power Factor / Phase Angle:	For Active / Reactive Power & Energy 10... 100% of Nominal Current & 50... 100% of Nominal Voltage. 40... 100% of Nominal Current & 50... 100% of Nominal Voltage.

Nominal range of use of influence quantities for measurands

Voltage:	50 .. 120 % of Rated Value
Current:	10 .. 120 % of Rated Value Rated
Input frequency:	Value ± 10 %
Temperature:	0 to 50° C
Auxiliary supply voltage	Rated Value ± 10 %
Auxiliary supply frequency	Rated Value ± 10 %
Temperature Coefficient (For Rated value range of use 0 .. 50° C)	0.025% / °C for Voltage (50..120% of Rated Value) 0.05% / °C for Current (10..120% of Rated Value)
Error change due to variation of an influence quantity:	2 * Error allowed for the reference condition applied in the test

Standards

EMC Emission:	IEC 61326-1: 2005
EMC Immunity:	10V/m min (IEC 61000-4-3)
Safety:	IEC 61010-1: 2001
Protection class:	2
Pollution degree:	2
Installation category:	CATIII
Enclosure (IP for water & dust):	IP 54 (front), IP 20 (housing/terminals) acc. to IEC 60529

Isolation

Dielectric voltage withstand test:	2.2 kV RMS 50 Hz for 1 minute between all electrical circuits
------------------------------------	---

Environmental

Operating temperature:	-10 to 55 ° C
Storage temperature:	-20 to +65 ° C
Relative humidity:	0 .. 90 % RH
Warm up time:	3 minute (minimum)
Shock:	15g in 3 planes
Vibration:	10 .. 55 Hz, 0.15mm amplitude

Mechanical attributes

Orientation:	Any
Dimensions:	see dimensional drawing
Material:	Polycarbonate, V-0 acc. to UL94, self-extinguishing, non-dripping, free of halogen
Weight:	620 g Approx.
Terminals:	Screw-type terminals
Display:	3 line / 4 digits LED display (Digit height 11mm) Approx. 1 seconds
User interface:	Two push buttons

Outputs

Pulse output Option (1 Relay)

Relay:	1NO + 1NC
Switching Voltage & Current:	240VDC , 5Amp.
Default Pulse rate Divisor:	1 per Wh (up to 3600W), 1 per kWh (up to 3600kW), 1 per MWh (above 3600 kW)
Pulse rate Divisors:	Programmable on site
10	1 per 10Wh (up to 3600W), 1 per 10kWh (up to 3600kW), 1 per 10MWh (above 3600 kW)
100	1 per 100Wh (up to 3600W), 1 per 100kWh (up to 3600kW), 1 per 100MWh (above 3600 kW)
1000	1 per 1000Wh (up to 3600W), 1 per 1000kWh (up to 3600kW), 1 per 1000MWh (above 3600 kW)
Pulse Duration ModBus (RS 485) Option:	60ms , 100ms or 200ms

Note: Above conditions are also applicable for Reactive & Apparent Energy.

Modbus (RS485):

Protocol:	Screw-type terminals (A, B, G)
Baud Rate:	ModBus (RS 485)
Parity:	19200 , 9600 , 4800 or 2400 (Programmable)
	Odd or Even, with 1 stop bit, Or None with 1 or 2 stop bits

RJ45 Modbus/TCP

Modbus /RTU:	RJ45 connector
Protocol:	Modbus/TCP
Physics:	Ethernet

Analog Output:

Linear:	4 ... 20mA dc into 0 - 500 ohm Uni-directional, internally powered.
---------	---

14.1 Dimensional drawings

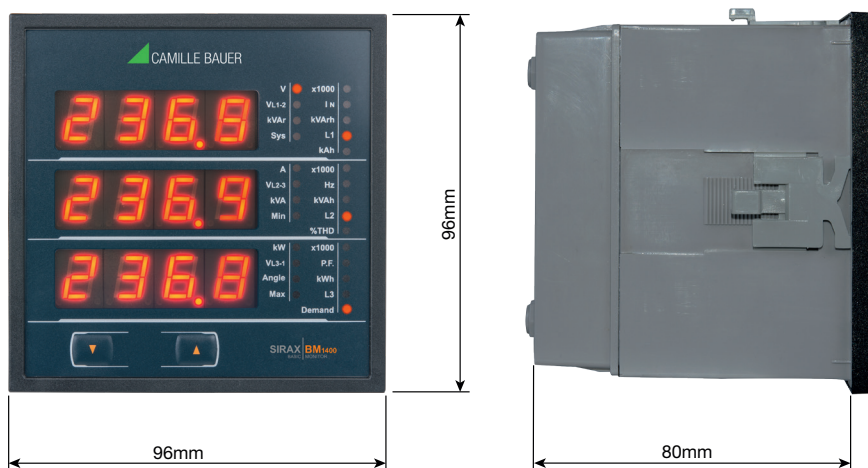

14.2 Phasor Diagram

- Quadrant 1:** 0° to 90°
- Quadrant 2:** 90° to 180°
- Quadrant 3:** 180° to 270°
- Quadrant 4:** 270° to 360°

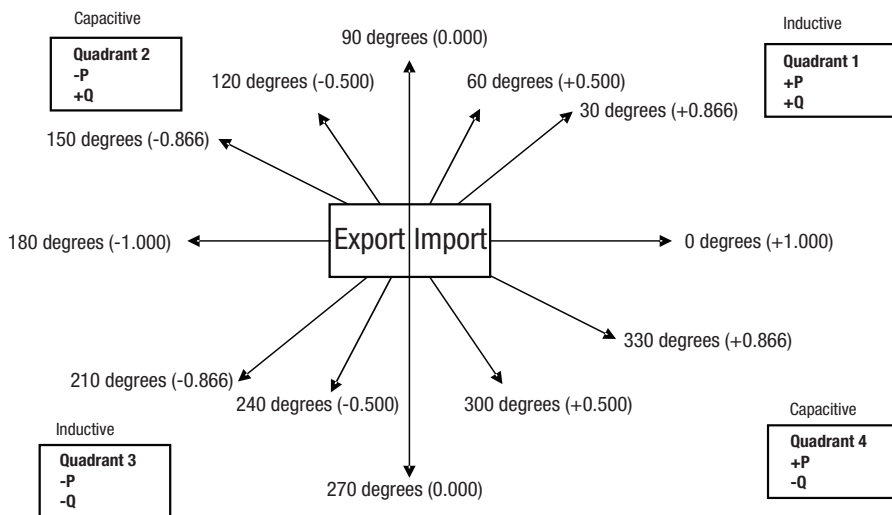

Connections	Quadrant	Sign of Active Power (P)	Sign of Reactive Power (Q)	Sign of Power Factor (PF)	Inductive/ Capacitive
Import	1	+ P	+ Q	+	L
Import	4	+ P	- Q	+	C
Export	2	- P	+ Q	-	C
Export	3	- P	- Q	-	L

Inductive means Current lags Voltage

Capacitive means Current leads Voltage

When the instrument displays Active power (P) with “+” (positive sign), the connection is “**Import**”.

When the instrument displays Active power (P) with “-” (negative sign), the connection is “**Export**”.

14.3 Connection and Programming via the RS485 (Modbus) interface

Follow the subsequent steps to program the transducer via the RS485 interface and Modbus:

Step 1: Connection

Connect the Modbus cable according to the connection diagram in Chapter 5.3. Please observe also the information in the Modbus (RS485) interface definition.

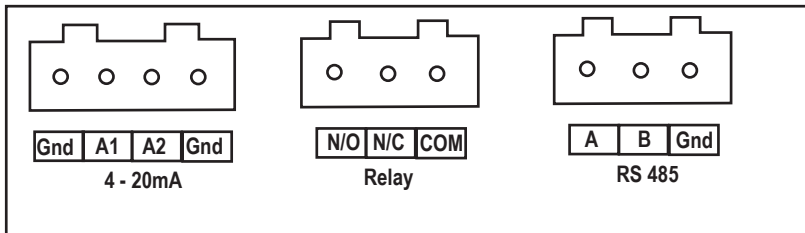

Step 2: Programming

Program SIRAX BM1400 via the Modbus RTU interface and the CB-Configurator software. Please observe the detailed Modbus description in Chapter 15.

Connect the power supply to SIRAX BM1400 before programming.

After completing the programming, the device must be rebooted.

14.4 Connection and programming via Ethernet RJ45 (Modbus TCP) interface

If you program the transmitter via the Ethernet RJ45 interface and Modbus, the following steps must be followed:

Step 1: Connection

Connect the Ethernet cable to the RJ45 interface on the device.



Step 2: Programming

The SIRAX BM1400 is programmed via the Modbus TCP interface and the programming software. The device is delivered with a factory-preset IP address of "192.168.11.11". This can be changed in the programming software, see on our homepage in the "manual Modbus/TCP Interface".

Please note that the device must be rebooted after adapting the new IP address. The detailed Modbus descriptions can be found in chapter 15.

The power supply must be connected to the SIRAX BM1400 before it can be programmed.

After completing the programming, the device must be rebooted.

15. Interface Definition Modbus (RS485)

SIRAX BM1400 supports Modbus RTU protocol (RS485).

The permissible address range for the BM1400 is between 1 and 247. Broadcast Mode (address 0) is not allowed.

The maximum latency time of an BM1400 is 200ms i.e. this is the amount of time that can pass before the first response character is output. After sending any query through software (of the Master), it must allow 200ms of time to elapse before assuming that the BM1400 is not going to respond. If slave does not respond within 200 ms, Master can ignore the previous query and can issue fresh query to the slave.

15.1 Modbus functions

Following code functions are provide:

Function code	Function	Address
03	Read holding registers	40001 to 40079
04	Read input registers	30001 to 30231
16	Presets multiple registers	40001 to 40079

Example of read out measurement

Query:

Device address	Function code	Start address	Nr. of register	CRC
0x05	0x04	0x000C	0x0006	0xB18F

Response:

Device address	Function code	Nr. of databytes	Databytes	Databytes	Databytes	CRC
0x05	0x04	0x0C	0x3F8A5AA7	0x3F844A12	0x3F85DAD2	0x4759

Example of set slave address 5 to 15

Query:

Device address	Function code	Start address	Nr. of register	Nr. of bytes	Databytes 0...3	CRC
0x05	0x10	0x0014	0x0002	0x04	0x41700000	0xF387

Response:

Device address	Function code	Start address	Nr. of register	CRC
0x05	0x10	0x0014	0x0002	0x0048

Exception Cases: An exception code will be generated when BM1400 receives ModBus query with valid parity and error check but which contains some other error (e.g. Attempt to set floating point variable to an invalid value). The response generated will be "Function code" + 0x80.

01	Illegal function	The function code is not supported.
02	Illegal data address	Attempt to access an invalid address or an attempt to read or write part of a floating point value.
03	Illegal data value	Attempt to set a floating point variable to an invalid value.

15.2 Data types

All information are displayed as 32-bit float. There is no representation for floating point numbers in the Modbus specification.

The IEEE 754 standard as the most often used standard for the representation of floating numbers is applied.

- The first register contains the bits 16 – 31
- The second register contains the bits 0 – 15

32-Bit Float (Real32)

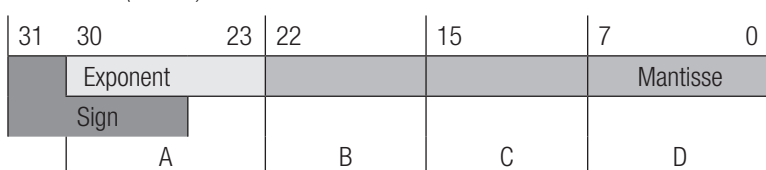

0x4017																0x4C05																		
0	1	0	0	0	0	0	0	0	0	0	0	0	1	0	1	1	1	0	1	0	0	1	1	0	0	0	0	0	0	0	0	1	0	1
+ Exponent: 128-127=1																Mantisse=1.010000000010111010011000000101=1.18200743198394781526789																		

Measuring value P = 1.18200743198394781526789 * 2¹ = 2.3640149 W

TABLE 1: 3 X register addresses (measured parameters)

Address (Register)	Name	Parameter	3P 4W	3P 3W
30001	U1N	Voltage phase L1 to N	• (L1-N)	• (L1-L2)
30003	U2N	Voltage phase L2 to N	• (L2-N)	• (L2-L3)
30005	U3N	Voltage phase L3 to N	• (L3-N)	• (L3-L1)
30007	I1	Current in phase L1	•	•
30009	I2	Current in phase L2	•	•
30011	I3	Current in phase L3	•	•
30013	P1	Active power phase 1 (L1 – N)	•	–
30015	P2	Active power phase 2 (L2 – N)	•	–
30017	P3	Active power phase 3 (L3 – N)	•	–
30019	S1	Apparent power phase 1 (L1 – N)	•	–
30021	S2	Apparent power phase 2 (L2 – N)	•	–
30023	S3	Apparent power phase 3 (L3 – N)	•	–
30025	Q1	Reactive power phase 1 (L1 – N)	•	–
30027	Q2	Reactive power phase 2 (L2 – N)	•	–
30029	Q3	Reactive power phase 3 (L3 – N)	•	–
30031	PF1	Power factor phase 1 (L1 – N)	•	–
30033	PF2	Power factor phase 2 (L2 – N)	•	–
30035	PF3	Power factor phase 3 (L3 – N)	•	–
30037	Phi 1	Phase angle 1	•	–
30039	Phi 2	Phase angle 2	•	–
30041	Phi 3	Phase angle 3	•	–
30043	U	Average value of voltages	•	•
30045	$\sum U$	Sum of voltages	•	•
30047	I	Average value of current	•	•
30049	$\sum I$	Sum of current	•	•
30051	P	Average value of active power	•	•
30053	$\sum P$	Sum of active power	•	•
30055	S	Average value of apparent power	•	•
30057	$\sum S$	Sum of apparent power	•	•
30059	Q	Average value of reactive power	•	•
30061	$\sum Q$	Sum of reactive power	•	•
30063	PF	Average value of power factor	•	•
30065	$\sum PF$	Sum of power factor	•	–
30067	Phi	Average value of phase angle	•	•
30069	$\sum Phi$	Sum of phase angle	•	–
30071	F	System frequency	•	•
30073	$\int P_{inc}$	Active power incoming	•	•
30075	$\int P_{out}$	Active power outgoing	•	•
30077	$\int Q_{inc}$	Reactive Power incoming	•	•
30079	$\int Q_{out}$	Reactive Power outgoing	•	•
30081	$\int S$	Apparent power	•	•
30083	Q	Electrical charge	•	•
30085	P_inc	Active power demand incoming	•	•
30087	P_inc max	Maximum active power demand incoming	•	•
30089	P_out	Active power demand outgoing	•	•
30091	P_out max	Maximum active power demand outgoing	•	•
30101	S	Apparent power demand	•	•

Adress (Register)	Name	Parameter	3P 4W	3P 3W
30103	S max.	Maximum apparent power demand	•	•
30105	U	Current demand	•	•
30107	U max.	Maximum current demand	•	•
30133	U max.	Maximum of the voltage average value	•	•
30135	U min.	Minimum of the voltage average value	•	•
30141	I max.	Maximum of the current average value	•	•
30143	I min.	Minimum of the current average value	•	•
30145	∫P_inc *	Active power incoming (kWh)	•	•
30147	∫P_out *	Active power outgoing (kWh)	•	•
30149	∫Q_inc *	Reactive Power incoming (kvarh)	•	•
30151	∫Q_out *	Reactive Power outgoing (kvarh)	•	•
30153	∫S *	Apparent power (kvah)	•	•
30201	U12	Voltage phase L1 to L2	•	–
30203	U23	Voltage phase L2 to L3	•	–
30205	U31	Voltage phase L2 to L1	•	–
30207	THD U1	Voltage THD in Line 1	•	•
30209	THD U2	Voltage THD in Line 2	•	•
30211	THD U3	Coltage THD in Line 3	•	•
30213	THD I1	Current THD in Line 1	•	•
30215	THD I2	Current THD in Line 2	•	•
30217	THD I3	Current THD in Line 3	•	•
30219	THD U	Voltage THD	•	•
30221	THD I	Current THD	•	•
30225	IN_calc	Neutral current (calculated)	•	–
30227	rh	Run hour	•	•
30229	Onh	On hour	•	•
30231	Intr	No. of interrupts	•	•
30513	Variable 1	Quantity is defined by user (see 40513 ... 40534)		
30515	Variable 2	Quantity is defined by user (see 40513 ... 40534)		
30517	Variable 3	Quantity is defined by user (see 40513 ... 40534)		
30519	Variable 4	Quantity is defined by user (see 40513 ... 40534)		
30521	Variable 5	Quantity is defined by user (see 40513 ... 40534)		
30523	Variable 6	Quantity is defined by user (see 40513 ... 40534)		
30525	Variable 7	Quantity is defined by user (see 40513 ... 40534)		
30527	Variable 8	Quantity is defined by user (see 40513 ... 40534)		
30529	Variable 9	Quantity is defined by user (see 40513 ... 40534)		
30531	Variable 10	Quantity is defined by user (see 40513 ... 40534)		
30533	Variable 11	Quantity is defined by user (see 40513 ... 40534)		
30535	Variable 12	Quantity is defined by user (see 40513 ... 40534)		
30537	Variable 13	Quantity is defined by user (see 40513 ... 40534)		
30539	Variable 14	Quantity is defined by user (see 40513 ... 40534)		
30541	Variable 15	Quantity is defined by user (see 40513 ... 40534)		
30543	Variable 16	Quantity is defined by user (see 40513 ... 40534)		
30545	Variable 17	Quantity is defined by user (see 40513 ... 40534)		
30547	Variable 18	Quantity is defined by user (see 40513 ... 40534)		
30549	Variable 19	Quantity is defined by user (see 40513 ... 40534)		
30551	Variable 20	Quantity is defined by user (see 40513 ... 40534)		

TABLE 2: Description of 4 X register

Adress	Param. No.	Name	Read/Write	Description																																																																								
40001	1	Demand Reset	R/W	Demand Reset is used to reset the Demand parameter. A value of zero must be Written to this register to reset the Demand period. Writing any other value will return an error.																																																																								
40003	2	Demand Period	R/W	Demand period represents demand time in minutes. The applicable values are 8,15,20 or 30. Writing any other value will return an error.																																																																								
40005	3	Energy unit	R/W	This address is used to set energy unit in Wh, kWh & MWh. Write one of the following value to this address. 1: Energy in Wh. 2: Energy in kWh. 3: Energy in MWh.																																																																								
40007	4	System Voltage	R	This address is read only and displays System Voltage																																																																								
40009	5	System Current	R	This address is read only and displays System Current																																																																								
40011	6	System Type	R/W	This address is used to set the System type. Write one of the following value to this address. 2: 3 Phase 3 Wire 3: 3 Phase 4 Wire. Writing any other value will return error.																																																																								
40013	7	Pulse Width of Relay	R/W	This address is used to set pulse width of the Pulse output. Write one of the following values to this address: 60: 60 ms 100: 100 ms 200: 200 ms Writing any other value will return error.																																																																								
40015	8	Reset Energy Counter	W	This address is used to reset the Energy Counter. Write zero value to this register to reset the energy counter. Writing any other value will return an error.																																																																								
40017	9	Number of Poles	W	This address is used to set the no. of poles of generator of which RPM is to be measured. The value must be between 2 to 40. Writing any other value will return an error.																																																																								
40019	10	Rs485 Set-up Code	R/W	This address is used to set the baud rate, Parity, Number of stop bits. <table border="1" data-bbox="630 1160 1489 1518"> <thead> <tr> <th>Value</th> <th>Baud rate</th> <th>Parity</th> <th>Stop bit</th> <th>Value</th> <th>Baud rate</th> <th>Parity</th> <th>Stop bit</th> </tr> </thead> <tbody> <tr> <td>0</td> <td>2400</td> <td>NONE</td> <td>1</td> <td>8</td> <td>9600</td> <td>NONE</td> <td>1</td> </tr> <tr> <td>1</td> <td>2400</td> <td>NONE</td> <td>2</td> <td>9</td> <td>9600</td> <td>NONE</td> <td>2</td> </tr> <tr> <td>2</td> <td>2400</td> <td>EVEN</td> <td>1</td> <td>10</td> <td>9600</td> <td>EVEN</td> <td>1</td> </tr> <tr> <td>3</td> <td>2400</td> <td>ODD</td> <td>1</td> <td>11</td> <td>9600</td> <td>ODD</td> <td>1</td> </tr> <tr> <td>4</td> <td>4800</td> <td>NONE</td> <td>1</td> <td>12</td> <td>19200</td> <td>NONE</td> <td>1</td> </tr> <tr> <td>5</td> <td>4800</td> <td>NONE</td> <td>2</td> <td>13</td> <td>19200</td> <td>NONE</td> <td>2</td> </tr> <tr> <td>6</td> <td>4800</td> <td>EVEN</td> <td>1</td> <td>14</td> <td>19200</td> <td>EVEN</td> <td>1</td> </tr> <tr> <td>7</td> <td>4800</td> <td>ODD</td> <td>1</td> <td>15</td> <td>19200</td> <td>ODD</td> <td>1</td> </tr> </tbody> </table>	Value	Baud rate	Parity	Stop bit	Value	Baud rate	Parity	Stop bit	0	2400	NONE	1	8	9600	NONE	1	1	2400	NONE	2	9	9600	NONE	2	2	2400	EVEN	1	10	9600	EVEN	1	3	2400	ODD	1	11	9600	ODD	1	4	4800	NONE	1	12	19200	NONE	1	5	4800	NONE	2	13	19200	NONE	2	6	4800	EVEN	1	14	19200	EVEN	1	7	4800	ODD	1	15	19200	ODD	1
Value	Baud rate	Parity	Stop bit	Value	Baud rate	Parity	Stop bit																																																																					
0	2400	NONE	1	8	9600	NONE	1																																																																					
1	2400	NONE	2	9	9600	NONE	2																																																																					
2	2400	EVEN	1	10	9600	EVEN	1																																																																					
3	2400	ODD	1	11	9600	ODD	1																																																																					
4	4800	NONE	1	12	19200	NONE	1																																																																					
5	4800	NONE	2	13	19200	NONE	2																																																																					
6	4800	EVEN	1	14	19200	EVEN	1																																																																					
7	4800	ODD	1	15	19200	ODD	1																																																																					
40021	11	Node Address	R/W	This register address is used to set Device address between 1 to 247.																																																																								
40023	12	Pulse Divisor	R/W	This address is used to set pulse divisor of the Pulse output. Write one of the following values to this address for Wh: 1 : Divisor 1 10 : Divisor 10 100 : Divisor 100 1000 : Divisor 1000 Writing any other value will return an error.																																																																								
40025	13	Min - Reset	W	This address is used to reset the Min parameters value. Write Zero value to this register to reset the Min parameters. Writing any other value will return an error.																																																																								
40027	14	Max - Reset	W	This address is used to reset the Max parameters value. Write Zero value to this register to reset the Max parameters. Writing any other value will return an error.																																																																								
40029	15	Analog Out 1-Para Set	R/W	This address is used to set the parameter for Analog Output 1. Write one of the parameter no. As per the options given in Table 2 for Analog & Limit Output Parameters. Writing any other value will return an error.																																																																								

Adress	Param. No.	Name	Read/ Write	Description																		
40031	16	Analog Out 2-Para Set	R/W	This address is used to set the parameter for Analog Output 2. Write one of the parameter no. As per the options given in Table 2 for Analog & Limit Output Parameters.																		
40033	17	PT Primary	R/W	<p>This address allows the user to set PT Primary value. The maximum settable value is 692.8kV & also depends on the per phase 666 MVA Restriction of power combined with CT primary.</p> <table border="1"> <tr> <td>Input voltage</td> <td></td> </tr> <tr> <td>110V L-L (63.5V L-N)</td> <td>Available</td> </tr> <tr> <td>230V L-L (133.0V L-N)</td> <td>on demand</td> </tr> <tr> <td>415V L-L (239.6V L-N)</td> <td>on demand</td> </tr> <tr> <td>440V L-L (239.6V L-N)</td> <td>Available</td> </tr> </table>	Input voltage		110V L-L (63.5V L-N)	Available	230V L-L (133.0V L-N)	on demand	415V L-L (239.6V L-N)	on demand	440V L-L (239.6V L-N)	Available								
Input voltage																						
110V L-L (63.5V L-N)	Available																					
230V L-L (133.0V L-N)	on demand																					
415V L-L (239.6V L-N)	on demand																					
440V L-L (239.6V L-N)	Available																					
40035	18	CT Pimary	R/W	This address allows the user to set CT Primary value. The maximum settable value is 9999 & also depends on the per phase 666 MVA Restriction of power combined with PT primary.																		
40037	19	Sys Power	R/W	System Power (Read Only) is the Nominal system power based on the values of Nominal system volts and Nominal system current.																		
40039	20	Energy Digit Reset Count	R/W	This address is used to set the rollover count for energy. If Energy on Modbus is in Wh, rollover count can be from 7 to 14. If it is in KWh then rollover count can be from 7 to 12 & for MWh rollover count can be from 7 to 9.																		
40041	21	Word Order	R/W	<p>Word Order controls the order in which SIRAX BT5700 receives or sends floating - point numbers:- normal or reversed register order. In normal mode, the two registers that make UP a floating point numbers are sent most significant bytes first. In reversed register mode, the two registers that make UP a floating point numbers are sent least significant bytes first.</p> <p>To set the mode, write the value '2141.0' into this register-the instrument will detect the order used to send this value and set that order for all ModBus transaction involving floating point numbers.</p>																		
40043	22	CT secondary	R/W	<p>This address is used to read and write the CT secondary value. Write one of the following values to this address.</p> <p>1: 1A CT secondary 5: 5A CT secondary</p> <p>writing any other value will return an error.</p>																		
40045	23	PT secondary	R/W	<p>This address is used to read and write the PT secondary value. Ref Table for the range of PT secondary settable values.</p> <table border="1"> <tr> <td>Input voltage</td> <td>Setting range PT secondary value</td> <td></td> </tr> <tr> <td>110V L-L (63.5V L-N)</td> <td>100 - 120V L-L (57.73V - 69.28V L-N)</td> <td>Available</td> </tr> <tr> <td>230V L-L (133.0V L-N)</td> <td>121 - 239V L-L (69.68V - 138V L-N)</td> <td>on demand</td> </tr> <tr> <td>415V L-L (239.6V L-N)</td> <td>240 - 480V L-L (138.56 - 277.12V L-N)</td> <td>on demand</td> </tr> <tr> <td>440V L-L (239.6V L-N)</td> <td>240 - 480V L-L (138.56 - 277.12V L-N)</td> <td>Available</td> </tr> </table>	Input voltage	Setting range PT secondary value		110V L-L (63.5V L-N)	100 - 120V L-L (57.73V - 69.28V L-N)	Available	230V L-L (133.0V L-N)	121 - 239V L-L (69.68V - 138V L-N)	on demand	415V L-L (239.6V L-N)	240 - 480V L-L (138.56 - 277.12V L-N)	on demand	440V L-L (239.6V L-N)	240 - 480V L-L (138.56 - 277.12V L-N)	Available			
Input voltage	Setting range PT secondary value																					
110V L-L (63.5V L-N)	100 - 120V L-L (57.73V - 69.28V L-N)	Available																				
230V L-L (133.0V L-N)	121 - 239V L-L (69.68V - 138V L-N)	on demand																				
415V L-L (239.6V L-N)	240 - 480V L-L (138.56 - 277.12V L-N)	on demand																				
440V L-L (239.6V L-N)	240 - 480V L-L (138.56 - 277.12V L-N)	Available																				
40047	24	Relay1 output select	R/W	<p>This address is used to select the Relay1 operation as pulse or Limit.</p> <p>Write one of the following values to this address.</p> <p>0: Pulse output on Relay1 128 (Decimal): Limit output on Relay1. Writing any other value will return an error.</p>																		
40049	25	Pulse 1 / Limit 1 parameter select	R/W	<p>This address is used to assign the Parameter to Relay1</p> <p>If Limit option is selected refer parameter number 1 to 40 & if Pulse option is selected then refer as followed.</p> <table border="1"> <tr> <td>Code</td> <td>Configuration</td> <td>Code</td> <td>Configuration</td> <td>Code</td> <td>Configuration</td> </tr> <tr> <td>0</td> <td>Import Active Energy</td> <td>2</td> <td>Import Reactive Energy</td> <td>4</td> <td>Apparent Energy</td> </tr> <tr> <td>1</td> <td>Export Active Energy</td> <td>3</td> <td>Export Reactive Energy</td> <td></td> <td></td> </tr> </table>	Code	Configuration	Code	Configuration	Code	Configuration	0	Import Active Energy	2	Import Reactive Energy	4	Apparent Energy	1	Export Active Energy	3	Export Reactive Energy		
Code	Configuration	Code	Configuration	Code	Configuration																	
0	Import Active Energy	2	Import Reactive Energy	4	Apparent Energy																	
1	Export Active Energy	3	Export Reactive Energy																			

Address	Param. No.	Name	Read/Write	Description																				
40051	26	Limit 1 Trip Point	R/W	This address is used to set the trip point in %. Any value between 10 to 100 for Lo- alarm & 10 to 120 for Hi-alarm can be written to this address. Writing any other value will return an error.																				
40053	27	Limit 1 Hysteresis	R/W	This address is used to set the hysteresis between 0.5 to 50.0%. Writing any other value will return an error.																				
40055	28	Limit 1 Energizing Delay	R/W	This address is used to set the Energizing delay between 1 to 10. Writing any other value will return an error.																				
40057	29	Limit 1 De-energizing Delay	R/W	This address is used to set the De-Energizing delay between 1 to 10. Writing any other value will return an error.																				
40071	36	Password	R/W	This address is used to set & reset the password. Valid Range of Pass-word can be set is 0000 - 9999. 1) If password lock is present & if this location is read it will return zero. 2) If Password lock is absent & if this location is read it will return One. 3) If password lock is present & to disable this lock first send valid pas word to this location then write "0000" to this location 4) If password lock is present & to modify 4X parameter first send valid password to this location so that 4X parameter will be accessible for modification. 5) If for in any of the above case invalid password is send then meter will return exceptional error 2.																				
40073	37	Limit 1 Configuration Select	R/W	This address is used to set the Configuration for Relay 1. Writing any other value will return an error. <table border="1" data-bbox="635 913 1490 1039"> <thead> <tr> <th>Code</th> <th>Configuration</th> <th>Code</th> <th>Configuration</th> </tr> </thead> <tbody> <tr> <td>0</td> <td>Hi- alarm & energized relais</td> <td>2</td> <td>Low- alarm & energized relais</td> </tr> <tr> <td>1</td> <td>Hi- alarm & de-energized relais</td> <td>3</td> <td>Low- alarm & de-energized relais</td> </tr> </tbody> </table>	Code	Configuration	Code	Configuration	0	Hi- alarm & energized relais	2	Low- alarm & energized relais	1	Hi- alarm & de-energized relais	3	Low- alarm & de-energized relais								
Code	Configuration	Code	Configuration																					
0	Hi- alarm & energized relais	2	Low- alarm & energized relais																					
1	Hi- alarm & de-energized relais	3	Low- alarm & de-energized relais																					
40077	39	Auto scroll	R/W	This address is used to activate or de-activate the auto scrolling. Write 0: Deactivate 1: Activate, Writing any other value will return an error.																				
40079	40	30mA Noise current Elimination	R/W	This address is used to activate or de-activate the 30 mA noise current elimination write 0: Deactivate 30 (Decimal): Activate Writing any other value will return an error.																				
40513	257	Variable 1	R/W	defines the value of the register 30513/30514																				
40514	258	Variable 2	R/W	defines the value of the register 30515/30516																				
40515	259	Variable 3	R/W	<table border="1" data-bbox="678 1442 1380 1845"> <thead> <tr> <th>Value</th> <th>Name</th> </tr> </thead> <tbody> <tr> <td>0</td> <td>Voltage UL 1</td> </tr> <tr> <td>2</td> <td>Voltage UL2</td> </tr> <tr> <td>4</td> <td>Voltage UL3</td> </tr> <tr> <td>...</td> <td></td> </tr> <tr> <td>70</td> <td>Frequency</td> </tr> <tr> <td>...</td> <td></td> </tr> <tr> <td>144</td> <td>Active power incoming</td> </tr> <tr> <td>224</td> <td>Neutral current</td> </tr> <tr> <td>Value</td> <td>= 3X Register Address – 30001</td> </tr> </tbody> </table>	Value	Name	0	Voltage UL 1	2	Voltage UL2	4	Voltage UL3	...		70	Frequency	...		144	Active power incoming	224	Neutral current	Value	= 3X Register Address – 30001
Value	Name																							
0	Voltage UL 1																							
2	Voltage UL2																							
4	Voltage UL3																							
...																								
70	Frequency																							
...																								
144	Active power incoming																							
224	Neutral current																							
Value	= 3X Register Address – 30001																							
40516	260	Variable 4	R/W																					
40517	261	Variable 5	R/W																					
40518	262	Variable 6	R/W																					
40519	263	Variable 7	R/W																					
40520	264	Variable 8	R/W																					
40521	265	Variable 9	R/W																					
40522	266	Variable 10	R/W																					
40523	267	Variable 11	R/W																					
40524	268	Variable 12	R/W																					
40527	269	Variable 13	R/W																					
40528	270	Variable 14	R/W																					
40529	271	Variable 15	R/W																					
40530	272	Variable 16	R/W																					
40531	273	Variable 17	R/W																					
40532	274	Variable 18	R/W																					
40533	275	Variable 19	R/W																					
40534	276	Variable 20	R/W	defines the value of the register 30551/30552																				

