

Device handbook

SINEAX DM5000

Operating Instructions SINEAX DM5000 (2020-11)



GMC INSTRUMENTS

Camille Bauer Metrawatt AG
Aargauerstrasse 7
CH-5610 Wohlen / Switzerland

Phone: +41 56 618 21 11
Telefax: +41 56 618 35 35

E-Mail: info@cbmag.com
<https://www.camillebauer.com>

Legal information

 **CAMILLE BAUER**

Warning notices

In this document warning notices are used, which you have to observe to ensure personal safety and to prevent damage to property. Depending on the degree of danger the following symbols are used:



If the warning notice is not followed death or severe personal injury **will** result.



If the warning notice is not followed damage to property or severe personal injury **may** result.



If the warning notice is not followed the device **may** be damaged or **may** not fulfill the expected functionality.

Qualified personnel

The product described in this document may be handled by personnel only, which is qualified for the respective task. Qualified personnel have the training and experience to identify risks and potential hazards when working with the product. Qualified personnel are also able to understand and follow the given safety and warning notices.

Intended use

The product described in this document may be used only for the application specified. The maximum electrical supply data and ambient conditions specified in the technical data section must be adhered. For the perfect and safe operation of the device proper transport and storage as well as professional assembly, installation, handling and maintenance are required.

Disclaimer of liability

The content of this document has been reviewed to ensure correctness. Nevertheless it may contain errors or inconsistencies and we cannot guarantee completeness and correctness. This is especially true for different language versions of this document. This document is regularly reviewed and updated. Necessary corrections will be included in subsequent version and are available via our webpage <https://www.camillebauer.com>.

Feedback

If you detect errors in this document or if there is necessary information missing, please inform us via e-mail to: customer-support@camillebauer.com

Contents

1. Introduction	5
1.1 Purpose of this document	5
1.2 Scope of supply	5
1.3 Further documents	5
2. Safety notes	6
3. Device overview	6
3.1 Brief description	6
3.2 Device overview	7
3.3 Available measurement data	8
4. Mechanical mounting	9
5. Electrical connections	10
5.1 General safety notes	10
5.2 Terminal assignments of the I/O extensions	11
5.3 Current input connections	11
5.4 Possible cross sections and tightening torques	11
5.5 Inputs	12
5.6 Power supply	24
5.7 Relays	24
5.8 Digital inputs	24
5.9 Digital outputs	25
5.10 Analog outputs	26
5.11 Modbus interface RS485	26
5.12 Fault current detection	27
5.13 Temperature inputs	29
5.14 Uninterruptible power supply (UPS)	29
5.15 GPS time synchronization	30
6. Commissioning	32
6.1 Operating LED	32
6.2 Parametrization of the device functionality	33
6.3 Installation check	33
6.4 Ethernet installation	35
6.4.1 Settings	35
6.4.2 Connection of the standard interface	38
6.4.3 Connection of the IEC61850 interface	38
6.4.4 Connection of the PROFINET interface	38
6.4.5 MAC addresses	39
6.4.6 Communication tests	40
6.4.7 Resetting the communication settings	40
6.5 IEC 61850 interface	40
6.6 PROFINET IO interface	41
6.6.1 General stations description file (GSD)	41
6.6.2 Parameterization of the device	42
6.6.3 Validity of measurements	44
6.6.4 PROFINET state	44
6.7 Simulation of analog / digital outputs	45
6.8 Security system	45
6.8.1 RBAC management	46
6.8.2 User log in / out via website	49
6.8.3 User log in / out via local display	50
6.8.4 Whitelisting clients	51
6.8.5 Secure communication using https	51
6.8.6 Audit log (SYSLOG)	52
7. Operating the device	54

7.1	Operating elements	54
7.2	Selecting the information to display	54
7.3	Measurement displays and used symbols	55
7.4	Resetting measurement data	57
7.5	Configuration	57
7.5.1	Configuration at the device	57
7.5.2	Configuration via web browser	59
7.6	Alarming	61
7.6.1	Limit values on base quantities	61
7.6.2	Monitoring fault-currents	62
7.6.3	Temperature monitoring	63
7.6.4	Monitoring functions	64
7.6.5	Summary alarm	65
7.7	Data recording	66
7.7.1	Periodical data	66
7.7.2	User-defined events	69
7.7.3	Disturbance recorder	70
7.8	Measurement information in file format	73
7.8.1	Creating periodic file data	73
7.8.2	Accessing file information via webpage	74
7.8.3	Periodical sending to a SFTP Server	74
7.9	Timeouts	75
8.	Service, maintenance and disposal	76
8.1	Calibration and new adjustment	76
8.2	Cleaning	76
8.3	Battery	76
8.4	Disposal	76
9.	Technical data	77
Annex	84	
A	Description of measured quantities	84
A1	Basic measurements	84
A2	Harmonic analysis	88
A3	System imbalance	89
A4	Mean values and trend	90
A5	Meters	91
B	Display matrices	92
B0	Used abbreviations for the measurements	92
B1	Display matrices for single phase system	97
B2	Display matrices for split-phase (two-phase) systems	98
B3	Display matrices for 3-wire system, balanced load	99
B4	Display matrices for 3-wire system, balanced load, phase shift	100
B5	Display matrices for 3-wire systems, unbalanced load	101
B6	Display matrices for 3-wire systems, unbalanced load, Aron	102
B7	Display matrices for 4-wire system, balanced load	103
B8	Display matrices for 4-wire systems, unbalanced load	104
B9	Display matrices for 4-wire system, unbalanced load, Open-Y	105
C	Logic functions	106
D	FCC statement	107
INDEX	108	

1. Introduction

1.1 Purpose of this document

This document describes the universal measurement device for heavy-current quantities SINEAX DM5000. It is intended to be used by:

- Installation personnel and commissioning engineers
- Service and maintenance personnel
- Planners

Scope

This handbook is valid for all hardware versions of the DM5000. Some of the functions described in this document are available only, if the necessary optional components are included in the device.

Required knowledge

A general knowledge in the field of electrical engineering is required. For assembly and installation of the device knowledge of applicable national safety regulations and installation standard is required.

1.2 Scope of supply



- Measurement device SINEAX DM5000
- Safety instructions (multiple languages)
- Battery pack (optional, for devices with UPS only)

1.3 Further documents

The following documents are provided electronically via <https://www.camillebauer.com/dm5000-en> :

- Safety instructions SINEAX DM5000
- Data sheet SINEAX DM5000
- Modbus basics: General description of the communication protocol
- Modbus interface SINEAX DM5000: Register description for Modbus communication
- IEC61850 interface SINEAX AMx000/DM5000, LINAX PQx000, CENTRAX CUx000
- Camille Bauer certificate for encrypted HTTPS communication

2. Safety notes



Device may only be disposed in a professional manner!

The installation and commissioning should only be carried out by trained personnel.

Check the following points before commissioning:

- that the maximum values for all the connections are not exceeded, see "Technical data" section,
- that the connection wires are not damaged, and that they are not live during wiring,
- that the power flow direction and the phase rotation are correct.

The instrument must be taken out of service if safe operation is no longer possible (e.g. visible damage). In this case, all the connections must be switched off. The instrument must be returned to the factory or to an authorized service dealer.

It is forbidden to open the housing and to make modifications to the instrument. The instrument is not equipped with an integrated circuit breaker. During installation check that a labeled switch is installed and that it can easily be reached by the operators.

Unauthorized repair or alteration of the unit invalidates the warranty.

3. Device overview

3.1 Brief description

The SINEAX DM5000 is a comprehensive instrument for the universal measurement and monitoring in power systems. The device provides a wide range of functionalities which may even be extended by optional components. The nameplates on the device give further details about the present version. The device is connected to the process environment by communication interfaces, via digital I/Os, analog outputs or relays.

The device has been designed for universal use in industrial plants, building automation or in energy distribution. Nominal voltages of up to 690 V and measurement category CATIII can be directly connected in low voltage systems. The universal measuring system permits the direct use of the device in any type of grid, from single-phase mains through to 4-wire unbalanced load systems.

A comprehensive security concept protects the device from unauthorized access, eavesdropping of communication or data manipulations. Implemented security mechanisms are Role-Based Access Control (RBAC), encrypted data transmission via HTTPS, logging of all activities in an Audit log with Syslog protocol support, a client whitelist for limiting computers with access authorization and digitally signed firmware files for secure updates.

Optionally the DM5000 can be equipped with a TFT display, which allows adapting the device directly to the requirements on site. This can be done via the device webpage as well. No special software is required for device configuration or measurement display.

3.2 Device overview



Version: with display, with UPS



Version: without display, without UPS

	DM5000
Input channels voltage / current Measurement interval [#cycles]	4 / 4 10/12 (50/60Hz); 1/2
MEASURED VALUES Instantaneous values Extended reactive power analysis Imbalance analysis Neutral current Earth wire current (calculated) Zero displacement UNE Energy balance analysis Harmonic analysis Operating hour counters device / general Monitoring functions Visualisation waveform U/I	<ul style="list-style-type: none"> ▪ ▪ ▪ measured / calculated ▪ measured / calculated ▪ ▪ (incl. phase angle) 1 / 3 ▪ ▪
MEASUREMENT UNCERTAINTY Voltage, current Active, reactive, apparent power Frequency Active energy (IEC 62053-21/22) Reactive energy (IEC 62053-24)	<p>±0.1%</p> <p>±0.2%</p> <p>±10mHz</p> <p>Class 0.2S</p> <p>Class 0.2S</p>
DATA LOGGER (Option) Periodic recording Event recording Disturbance recorder (with pretrigger) a) 1/2 cycle RMS progression U/I b) Curve shape U/I [#cycles]	<p>≥16GB</p> <ul style="list-style-type: none"> ▪ ▪ <p>≤3min.</p> <p>5/6 (pretrigger) +10/12</p>
COMMUNICATION Ethernet: Modbus/TCP, web server, NTP IEC61850 PROFINET IO RS485: Modbus/RTU Standard I/Os Extension modules (optional)	<p>(standard)</p> <p>(option)</p> <p>(option)</p> <p>(standard)</p> <p>1 dig. IN ; 2 dig. OUT max. 2 modules</p>
POWER SUPPLY	<p>100-230V AC/DC</p> <p>24-48V DC</p>
DESIGN Colour display	TFT 3,5" (320x240px)

3.3 Available measurement data

The SINEAX DM5000 provides measurements in the following subcategories:

- a) **Instantaneous values:** Present TRMS values and associated min/max values
- b) **Energy:** Power mean-values with trend and history as well as energy meters. With the data logger option "periodical data" mean-value progressions (load profiles) and periodical meter readings are available as well.
- c) **Harmonics:** Total harmonic distortion THD/TDD, individual harmonics and their maximum values
- d) **Phasor diagram:** Overview of all current and voltage phasors and phase sequence check
- e) **Waveform display** of current and voltage inputs
- f) **Events:** State list of monitored alarms. With the data logger option also chronological lists of events and alarms as well as operator events are available

MEASURED VALUE GROUP	APPLICATION
INSTANTANEOUS VALUES U, I, IMS, P, Q, S, PF, LF, QF ... Angle between voltage phasors Min/max of instantaneous values with time stamp	Transparent monitoring of present system state Fault detection, connection check, sense of rotation check Determination of grid variable variance with time reference
EXTENDED REACTIVE POWER ANALYSIS Total reactive power, fundamental frequency, harmonics $\cos\phi$, $\tan\phi$ of fundamental frequency with min values in all quadrants	Reactive power compensation Verification of specified power factor
HARMONICS ANALYSIS (ACCORDING TO EN 61 000-4-7) Total harmonics content THD U/I and TDD I Individual harmonics U/I up to 50 th	Evaluation of the thermic load of equipment Analysis of system perturbation and consumer structure
IMBALANCE ANALYSIS Symmetrical components (positive, negative, zero sequence system) Imbalance (from symmetrical components) Deviation from U/I mean value	Equipment overload protection Fault/earth contact detection
ENERGY BALANCE ANALYSIS Meters for the demand/supply of active/reactive power, high/low tariff, meters with selectable fundamental variable Power mean values active/reactive power, demand and supply, freely definable mean values (e.g. phase power, voltage, current and much more). Mean value trends	Preparation of (internal) energy billing Determination of energy consumption versus time (load profile) for energy management or energy efficiency verification Energy consumption trend analysis for load management
OPERATING HOURS 3 operating hour counters with programmable running condition Operating hours of the device	Monitoring of service and maintenance intervals of equipments

4. Mechanical mounting



Please ensure that the [operating temperature limits](#) are not exceeded when determining the place of mounting (place of measurement).



By installing, the device becomes part of an electrical power installation that must be designed, operated and maintained in accordance with country-specific regulations so that the installation is safe and provides prevention against fire and explosion as far as possible.



It is the task of this installation to ensure that dangerous connections of the device can not be touched during operation and that the spread of flames, heat and smoke from the interior is prevented. This may be done by providing an enclosure (e.g. case, cabinet) or using a room accessible to qualified personal only and compliant with local fire safety standards.

The standard version of the DM5000 can be clipped onto a top-hat rail according to EN60715. Orientation as shown.

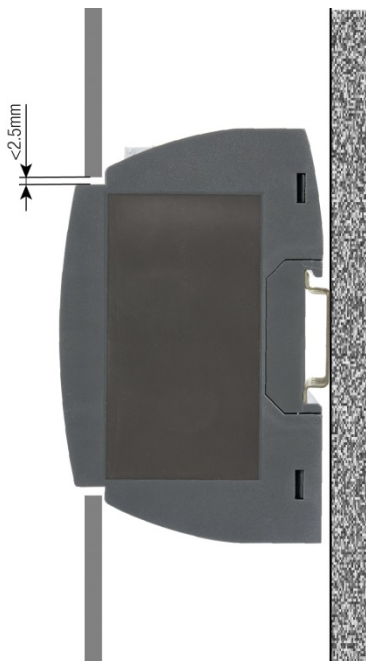
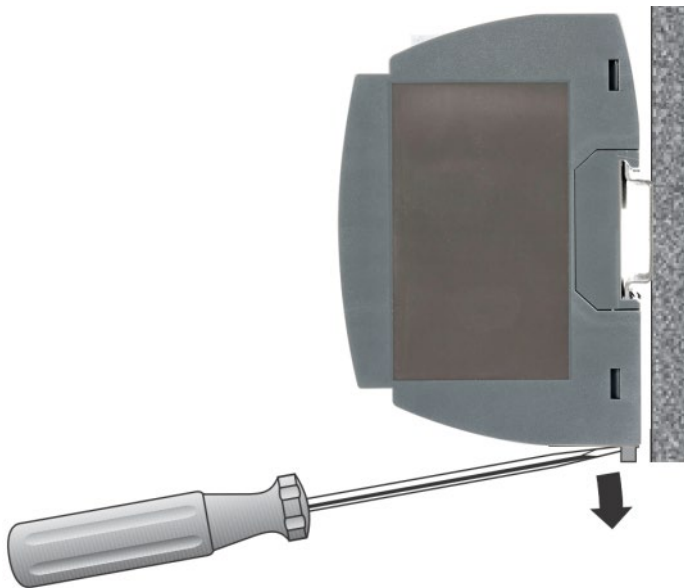

The device can also be mounted that the front of the device protrudes through a cut-out in the enclosure. So the operating buttons and the display become accessible. With centric mounting using the below maximum cut-out a gap between enclosure and device results, which does not exceed 2.5mm on each side.

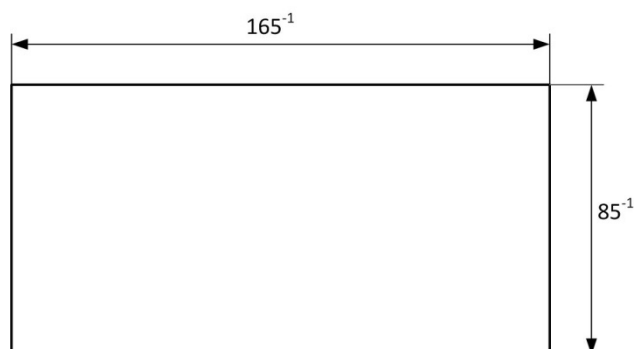

5. Electrical connections



Ensure under all circumstances that the leads are free of potential when connecting them!

5.1 General safety notes



Please observe that the data on the type plate must be adhered to!

The national provisions have to be observed in the installation and material selection of electric lines, e.g. in Germany VDE 0100 "Erection of power installations with nominal voltages up to 1000 V"!

DM5000-1111 1113 0					
MAC: 00:12:34:AE:00:64					
Ord.: 000/123456/123					
Man: 16 / 5					
X1		Option 1		X2	
250VAC / 30VDC, 2A					
1	2	3	1	2	3
X3		Option 2		X4	
$\pm 0...20\text{mA}$					
+4	+3	-	+2	+1	-
1	2	3	1	2	3
Li-Po Battery 4.5Wh					
$\rightarrow \bigcirc$ 100-230V \sim (50/60Hz)					
13	14	27VA			

CAMILLE BAUER Switzerland					
$\rightarrow \bigcirc$ 5A 50/60Hz, 300V CAT III					
I1	I2	I3	IN		
k \rightarrow l	k \rightarrow l	k \rightarrow l	k \rightarrow l		
1	3	4	6	7	9 10 12
$\rightarrow \bigcirc$ 3~ 690/400V (UL: 600/347V) 50/60Hz, 600V CATIII					
U1	U2	U3	N	PE	
2	5	8	11	16	
Modbus RS485			$\rightarrow \bigcirc$ D IN		
GND	-	+	+ -		
C/X	B	A	23 24		
$\rightarrow \bigcirc$ D OUT 1		$\rightarrow \bigcirc$ D OUT 2			
+	-	+	-		
19	20	21	22		

Nameplate of a device with

- TFT display
- Ethernet interface
- Modbus/RTU interface
- Data logger
- 2 relay outputs
- 4 analog outputs
- UPS

Symbol	Meaning
	Device may only be disposed of in a professional manner!
	Double insulation, device of protection class 2
	CE conformity mark. The device fulfills the requirements of the applicable EU directives.
	Products with this mark comply with both the Canadian (CSA) and the American (UL) requirements.
	Caution! General hazard point. Read the operating instructions.
	General symbol: Power supply
	General symbol: Input
	General symbol: Output
CAT III	Measurement category CAT III

5.2 Terminal assignments of the I/O extensions

Function	Option 1	Option 2
2 relay outputs	1.1: X1.1 / X1.2 / X1.3 1.2: X2.1 / X2.2 / X2.3	2.1: X3.1 / X3.2 / X3.3 2.2: X4.1 / X4.2 / X4.3
2 analog outputs	1.1: X2.2(+) / X2.3(-) 1.2: X2.1(+) / X2.3(-)	2.1: X4.2(+) / X4.3(-) 2.2: X4.1(+) / X4.3(-)
4 analog outputs	1.1: X2.2(+) / X2.3(-) 1.2: X2.1(+) / X2.3(-) 1.3: X1.2(+) / X1.3(-) 1.4: X1.1(+) / X1.3(-)	2.1: X4.2(+) / X4.3(-) 2.2: X4.1(+) / X4.3(-) 2.3: X3.2(+) / X3.3(-) 2.4: X3.1(+) / X3.3(-)
4 digital inputs (active)	1.1: X1.1(-) / X1.3(+) 1.2: X1.2(-) / X1.3(+) 1.3: X2.1(-) / X2.3(+) 1.4: X2.2(-) / X2.3(+)	2.1: X3.1(-) / X3.3(+) 2.2: X3.2(-) / X3.3(+) 2.3: X4.1(-) / X4.3(+) 2.4: X4.2(-) / X4.3(+)
4 digital inputs (passive)	1.1: X1.1(+) / X1.3(-) 1.2: X1.2(+) / X1.3(-) 1.3: X2.1(+) / X2.3(-) 1.4: X2.2(+) / X2.3(-)	2.1: X3.1(+) / X3.3(-) 2.2: X3.2(+) / X3.3(-) 2.3: X4.1(+) / X4.3(-) 2.4: X4.2(+) / X4.3(-)
2 temperature inputs	1.1: X1.2 / X1.3 1.2: X2.2 / X2.3	2.1: X3.2 / X3.3 2.2: X4.2 / X4.3

5.3 Current input connections



You may have to remove first the plug-in terminals to get access to the screw terminals of the current inputs.

5.4 Possible cross sections and tightening torques

Inputs L1(2), L2(5), L3(8), N(11), PE(16), I1(1-3), I2(4-6), I3(7-9), IN(10-12), power supply (13-14)	
Single wire	<ul style="list-style-type: none"> • 1 x 0,5...6.0mm² or 2 x 0,5...2.5mm² • 1 x 20 AWG...9 AWG or 2 x 20 AWG...14 AWG
Multiwire with end splices	<ul style="list-style-type: none"> • 1 x 0,5...4.0mm² or 2 x 0,5...2.5mm² • 1 x 20 AWG...11 AWG or 2 x 20 AWG...14 AWG
Tightening torque	<ul style="list-style-type: none"> • 0.5...0.6Nm • 4.42...5.31 lbf in
I/O's, relays, RS485 connector (A, B, C/X)	
Single wire	<ul style="list-style-type: none"> • 1 x 0.5 ... 2.5mm² or 2 x 0.5 ... 1.0mm² • 1 x 20 AWG...14 AWG or 2 x 20 AWG...17 AWG
Multiwire with end splices	<ul style="list-style-type: none"> • 1 x 0.5 ... 2.5mm² or 2 x 0.5 ... 1.5mm² • 1 x 20 AWG...14 AWG or 2 x 20 AWG...16 AWG
Tightening torque	<ul style="list-style-type: none"> • 0.5...0.6Nm • 4.42...5.31 lbf in

5.5 Inputs



All voltage measurement inputs must originate at circuit breakers or fuses rated 5 Amps or less. This does not apply to the neutral connector. You have to provide a method for manually removing power from the device, such as a clearly labeled circuit breaker or a fused disconnect switch in accordance with IEC 60947-2 or IEC 60947-3.

When using **voltage transformers** you have to ensure that their secondary connections never will be short-circuited.



No fuse may be connected upstream of the **current measurement inputs!**

When using **current transformers** their secondary connectors must be short-circuited during installation and before removing the device. Never open the secondary circuit under load.



When **measuring in systems with neutral wire** the connection of the inputs for the neutral current measurement and the earth connector for determining the zero displacement voltage is optional.

Further hints

- The connection of the inputs depends on the configured system (connection type).
- In the connection diagrams on the next pages conventional voltage transformers are used. If a voltage transformer with **extra windings** for measuring the homopolar voltage is applied, connections should be as shown below.

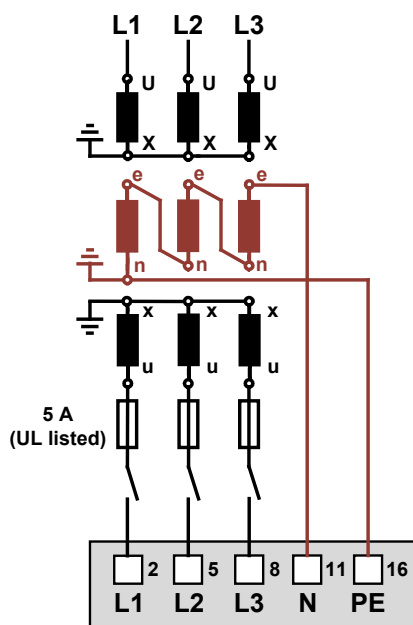

In order for the homopolar voltage to be measured, the item „Measure homopolar voltage“ must be set to „Yes“ in the settings of the measurement. This item is only available for 3-wire system types.

Single-phase AC mains

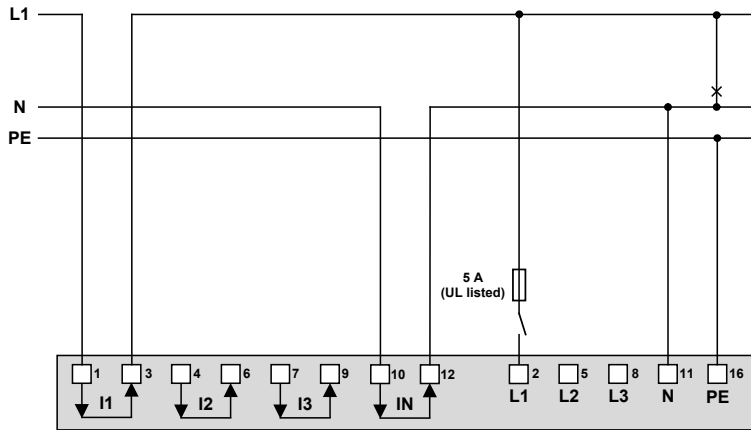

Direct connection

If current I_N or voltage U_{NE} does not need to be measured, connection of I_N or PE can be omitted.



Maximum permissible rated voltage
300V to ground!

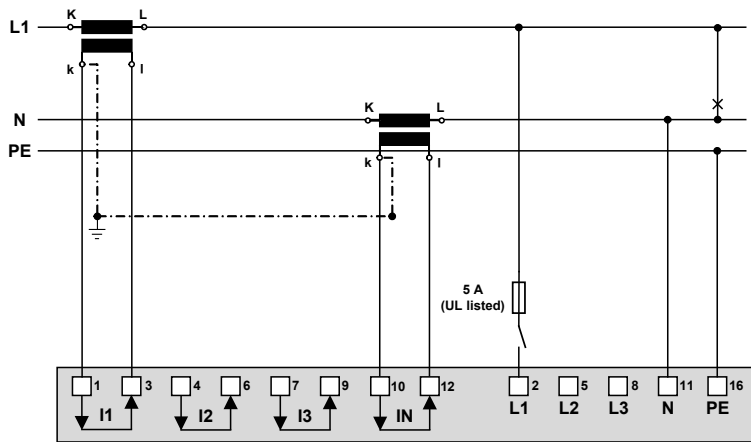

With current transformer

If current I_N does not need to be measured, the corresponding transformer can be omitted.

If voltage U_{NE} does not need to be measured, connection of PE can be omitted.

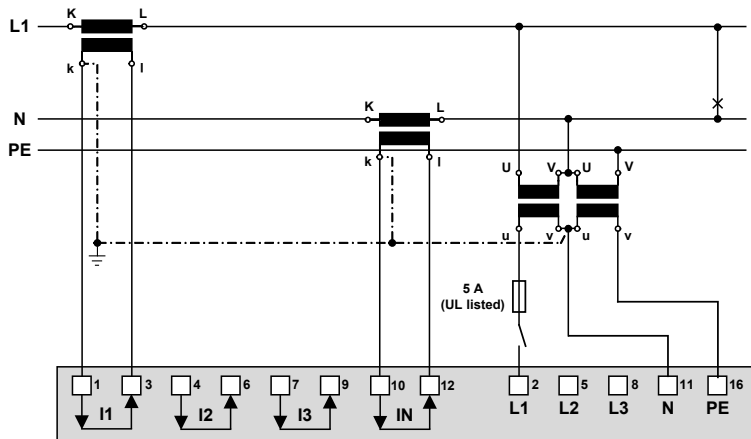

With current and voltage transformer

If current I_N or voltage U_{NE} does not need to be measured, the corresponding transformers can be omitted.

Three wire system, balanced load, phase shift
current measurement: L1, voltage measurement: L1-L2

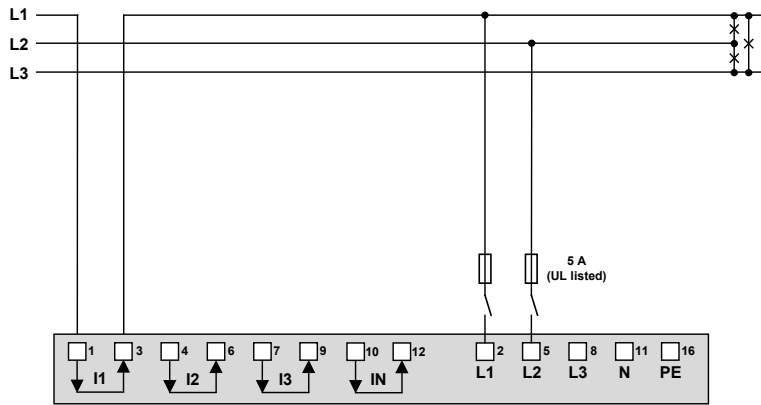

Direct connection

 Maximum permissible rated voltage
 300V to ground (520V ph-ph)!

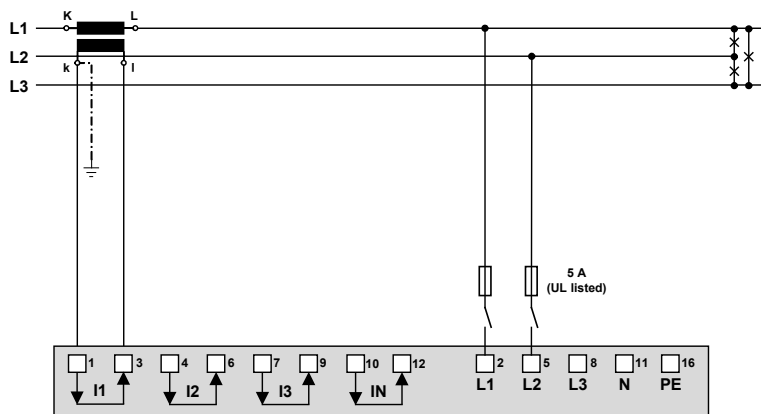

With current transformer

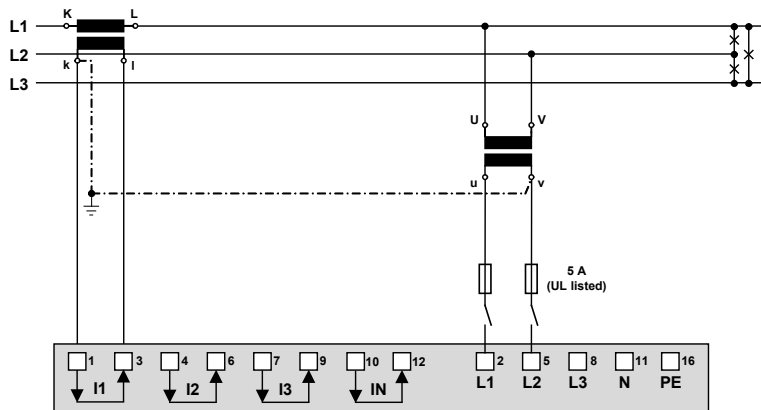

With current and voltage transformers

In case of current measurement via L2 or L3 connect the device according to the following table:

Terminals	1	3	2	5	8
Current meas. via L2	$I2(k)$	$I2(l)$	L2	L3	-
Current meas. via L3	$I3(k)$	$I3(l)$	L3	L1	-

Three wire system, balanced load, phase shift
current measurement: L1, voltage measurement: L2-L3

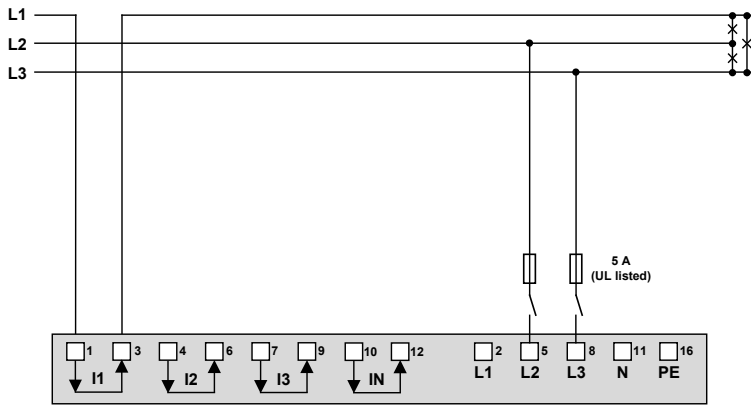

Direct connection

 Maximum permissible rated voltage
 300V to ground (520V ph-ph!)

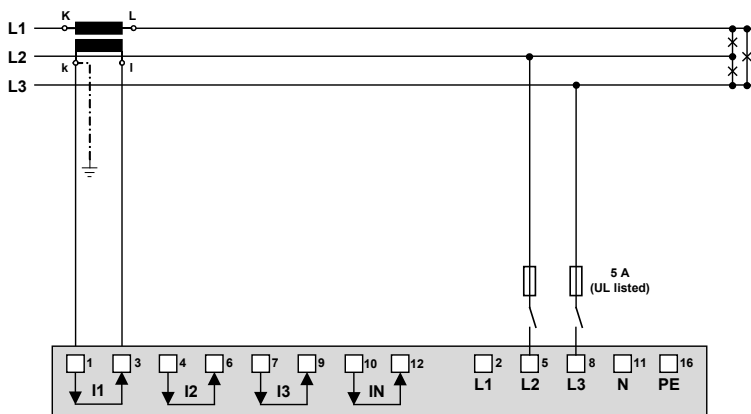

With current transformer

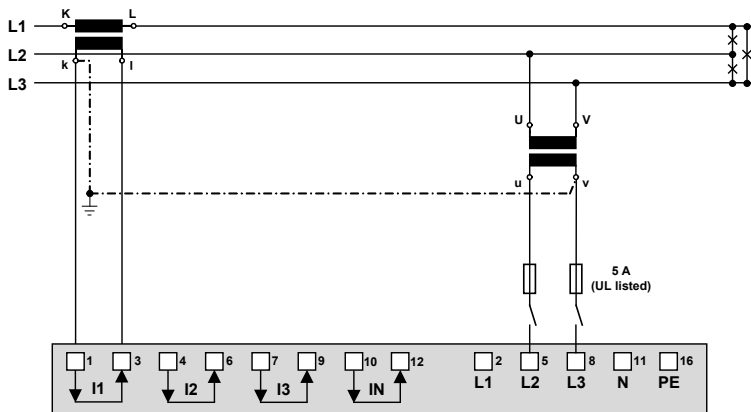

With current and voltage transformers

In case of current measurement via L2 or L3 connect the device according to the following table:

Terminals	1	3	2	5	8
Current meas. via L2	$I_2(k)$	$I_2(l)$	-	L3	L1
Current meas. via L3	$I_3(k)$	$I_3(l)$	-	L1	L2

Three wire system, balanced load, phase shift
current measurement: L1, voltage measurement: L3-L1

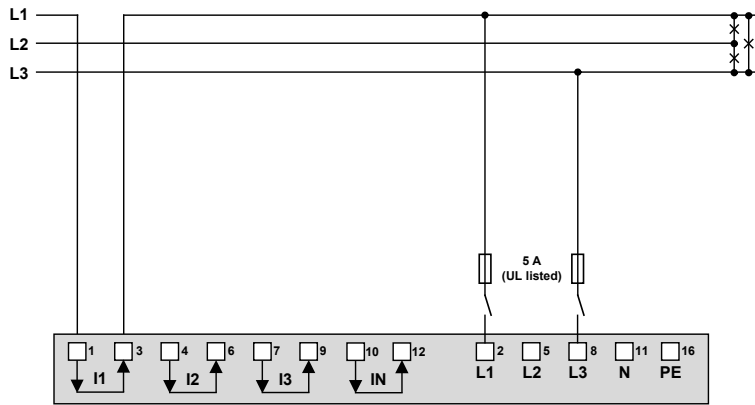

Direct connection

 Maximum permissible rated voltage
 300V to ground (520V ph-ph)!

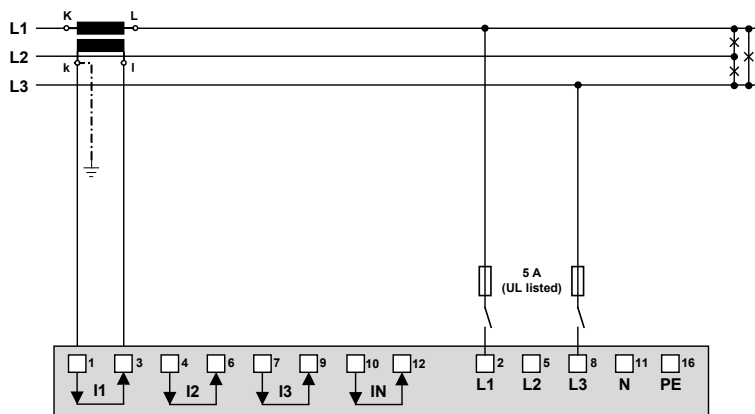

With current transformer

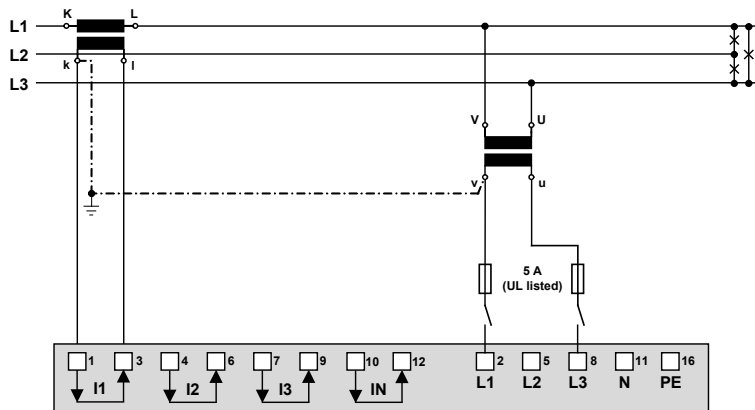

With current and voltage transformers

In case of current measurement via L2 or L3 connect the device according to the following table:

Terminals	1	3	2	5	8
Current meas. via L2	$I2(k)$	$I2(l)$	L2	-	L1
Current meas. via L3	$I3(k)$	$I3(l)$	L3	-	L2

Three wire system, balanced load, current measurement via L1

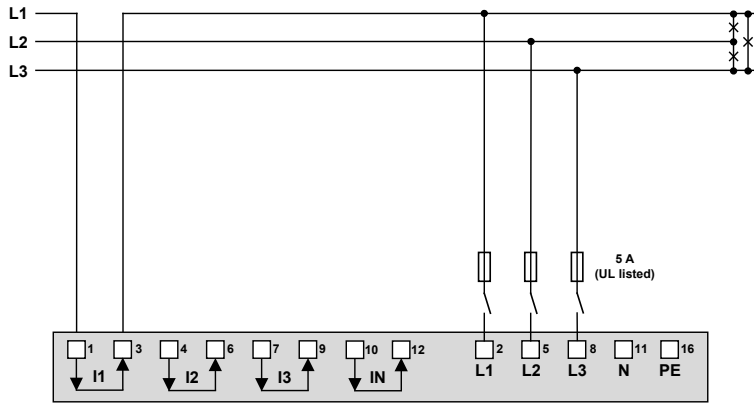

Direct connection

Maximum permissible rated voltage 300V to ground (520V ph-ph)!

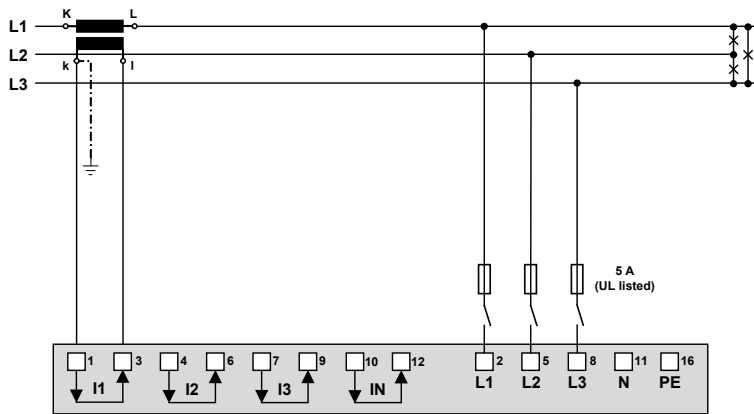

With current transformer

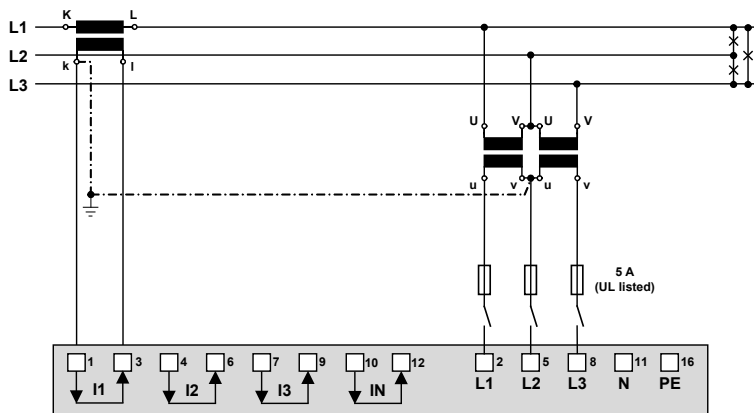

With current and voltage transformers

In case of current measurement via L2 or L3 connect the device according to the following table:

Terminals	1	3	2	5	8
Current meas. via L2	$I_2(k)$	$I_2(l)$	L2	L3	L1
Current meas. via L3	$I_3(k)$	$I_3(l)$	L3	L1	L2

By rotating the voltage connections the measurements U_{12} , U_{23} and U_{31} will be assigned interchanged!

Four wire system, balanced load, current measurement via L1

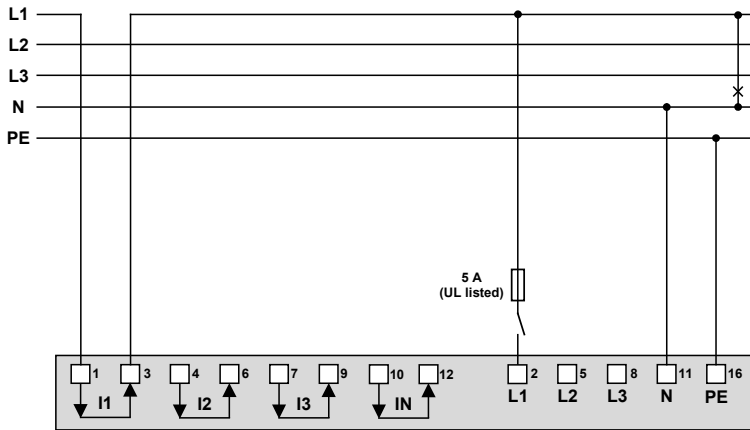

Direct connection

If voltage U_{NE} does not need to be measured, connection of PE can be omitted.



Maximum permissible rated voltage
300V to ground!

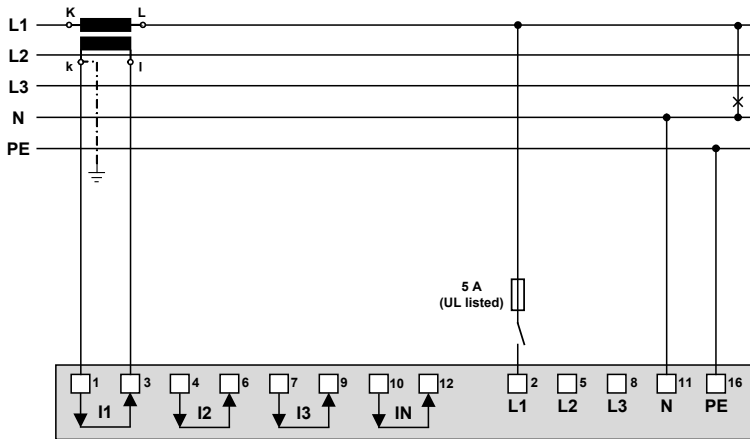

With current transformer

If voltage U_{NE} does not need to be measured, connection of PE can be omitted.

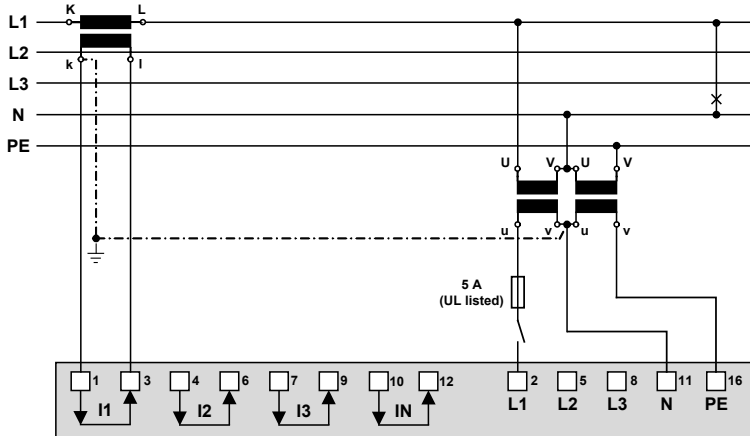

With current and voltage transformer

If voltage U_{NE} does not need to be measured, the corresponding transformer can be omitted.

In case of current measurement via L2 or L3 connect the device according to the following table:

Terminals	1	3	2	11
Current meas. via L2	I2(k)	I2(l)	L2	N
Current meas. via L3	I3(k)	I3(l)	L3	N

Three wire system, unbalanced load

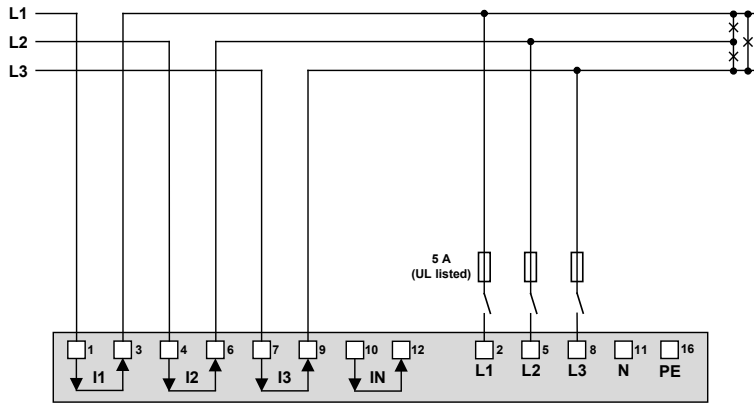

Direct connection

 Maximum permissible rated voltage 300V to ground (520V ph-ph)!

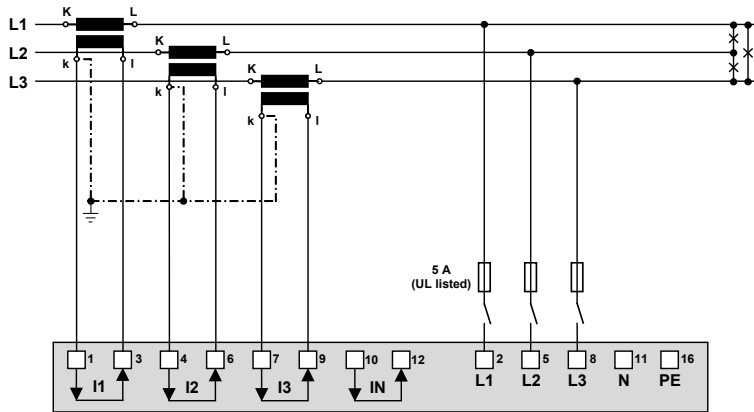

With current transformers

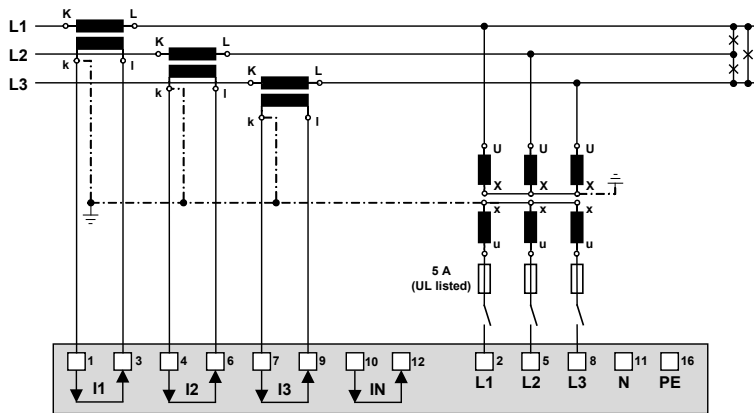

With current and 3 single-pole isolated voltage transformers

Three wire system, unbalanced load, Aron connection

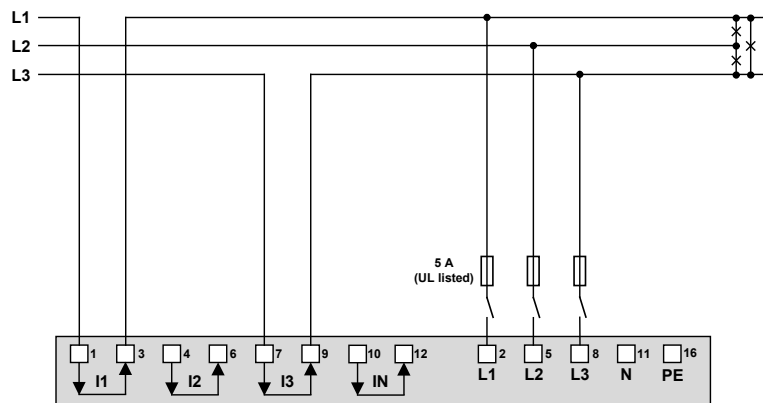

Direct connection



Maximum permissible rated voltage
300V to ground (520V ph-ph)!

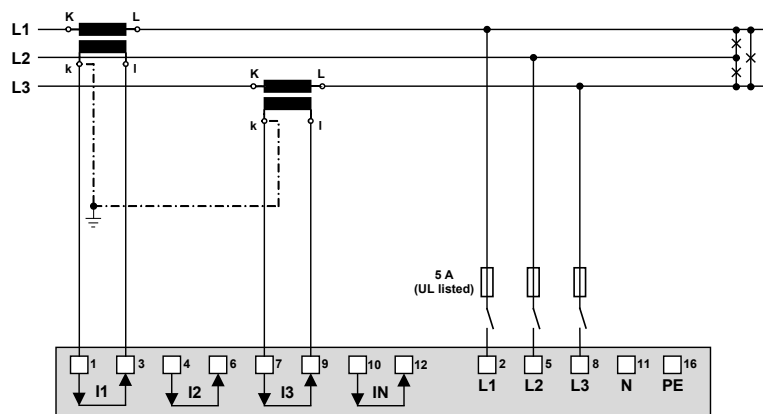

With current transformers

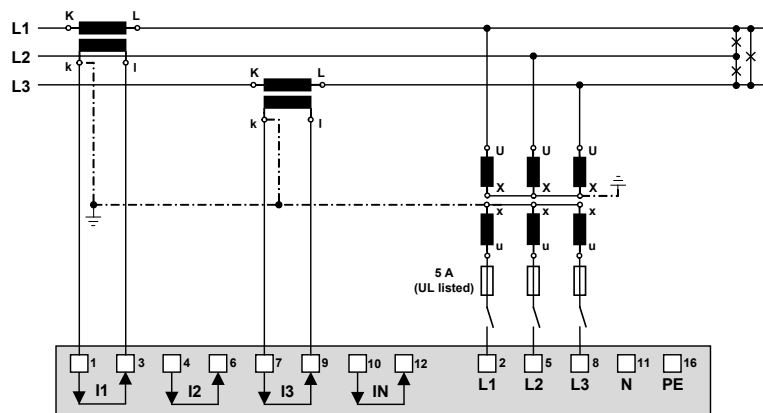

With current and 3 single-pole isolated
voltage transformers

Four wire system, unbalanced load

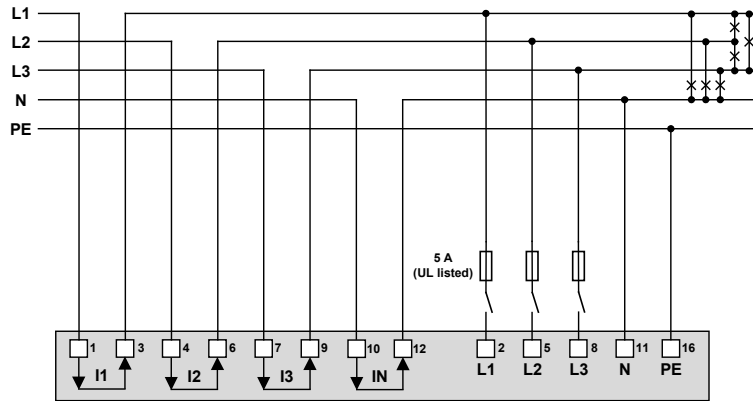

Direct connection

If current I_N or voltage U_{NE} does not need to be measured, connection of I_N or PE can be omitted.



Maximum permissible rated voltage
300V to ground (520V ph-ph)!

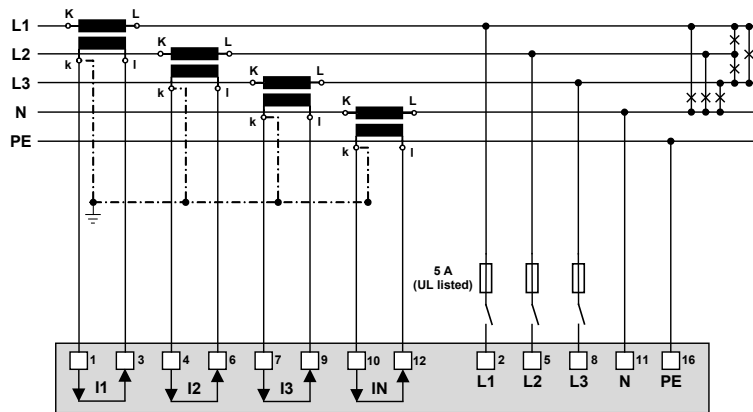

With current transformer

If voltage U_{NE} does not need to be measured, connection of PE can be omitted.

If current I_N does not need to be measured, the corresponding transformer can be omitted.

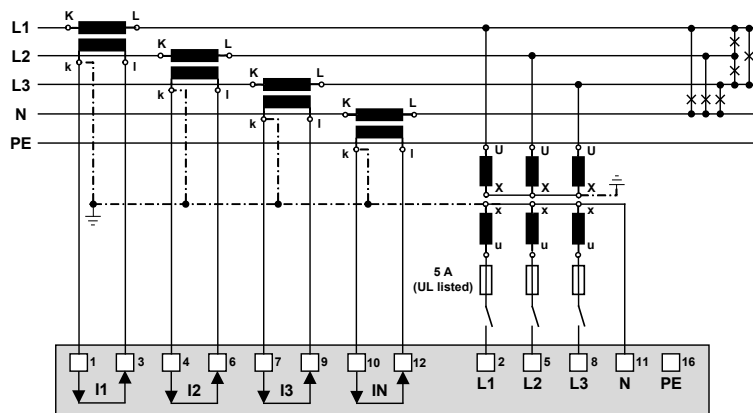

With current and voltage transformer

If current I_N does not need to be measured, the corresponding transformer can be omitted.

Four wire system, unbalanced load, Open-Y

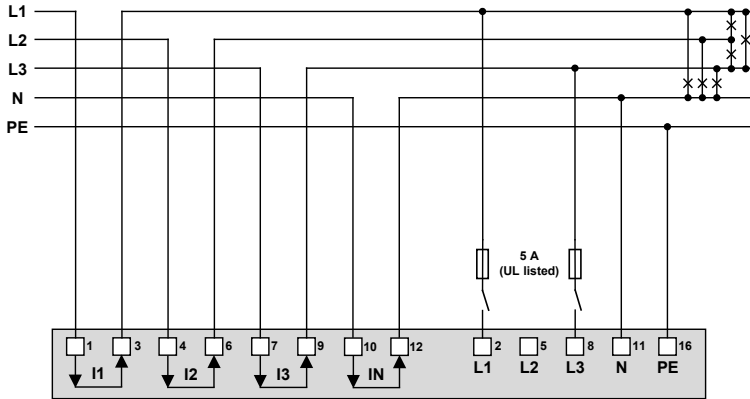

Direct connection

If current I_N or voltage U_{NE} does not need to be measured, connection of IN or PE can be omitted.



Maximum permissible rated voltage
300V to ground (520V ph-ph)!

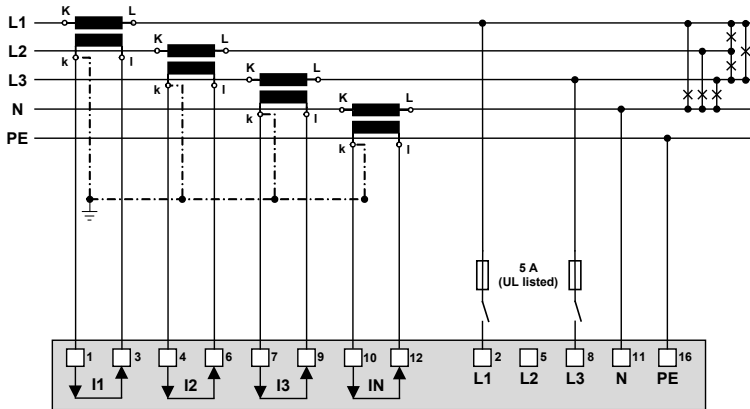

With current transformer

If voltage U_{NE} does not need to be measured, connection of PE can be omitted.

If current I_N does not need to be measured, the corresponding transformer can be omitted.

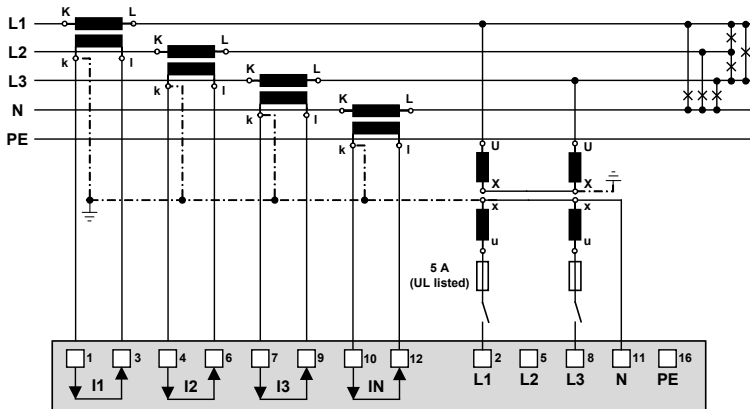

With current and voltage transformer

If current I_N does not need to be measured, the corresponding transformer can be omitted.

Split-phase ("two phase system"), unbalanced load

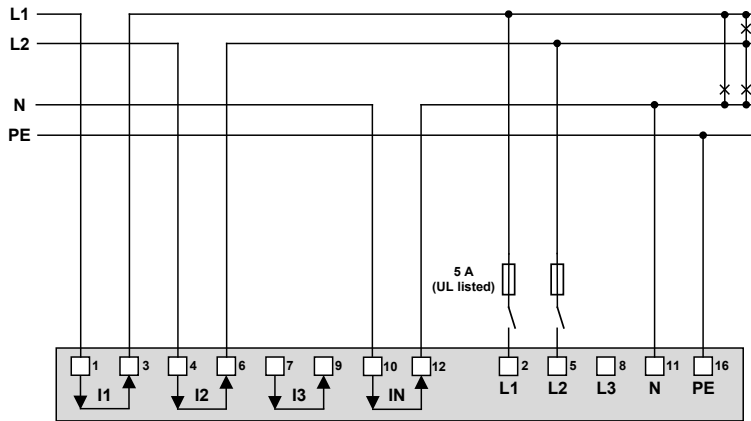

Direct connection



Maximum permissible rated voltage
300V to ground (600V ph-ph)!

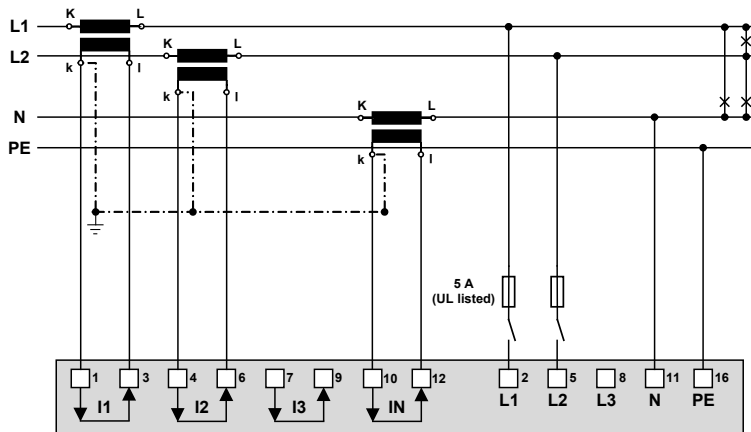

With current transformers

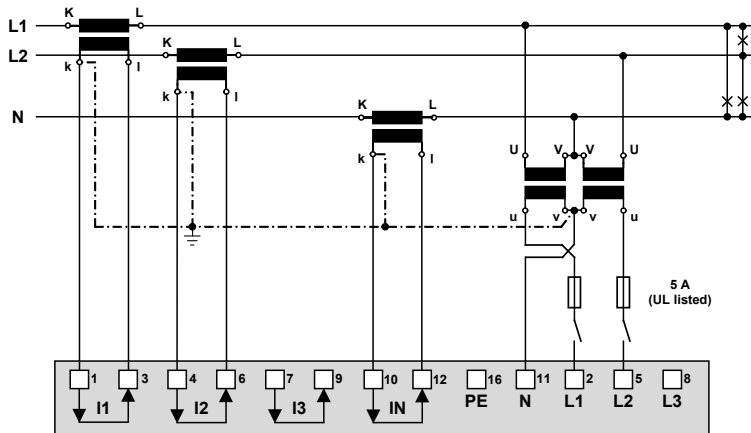

With current and voltage transformer

In systems without a primary neutral conductor a voltage transformer with a secondary center tap can also be used.

5.6 Power supply



A marked and easily accessible current limiting switch in accordance with IEC 60947-2 has to be arranged in the vicinity of the device for turning off the power supply. Fusing should be 10 Amps or less and must be rated for the available voltage and fault current.

5.7 Relays



When the device is switched off the relay contacts are de-energized, but dangerous voltages may be present.

Relays are available for device versions with corresponding I/O extensions only.

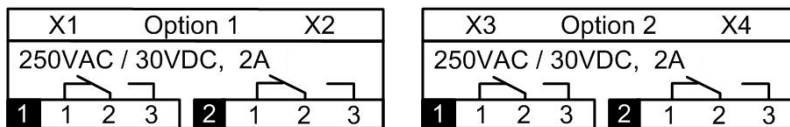

5.8 Digital inputs

The device provides a standard passive digital input. In addition, depending on the device version, there may be 4-channel passive or active digital input modules available.

Usage of the standard digital input

- ▶ Status input
- ▶ Meter tariff switching

Usage of the inputs of the optional input modules

- ▶ Counting input for pulses of meters for any kind of energy (pulse width 70...250ms)
- ▶ Operating feedback of loads for operating time counters
- ▶ Trigger and release signal for monitoring functions

Passive inputs (external power supply with 12 / 24 VDC required)



The power supply shall not exceed 30V DC!

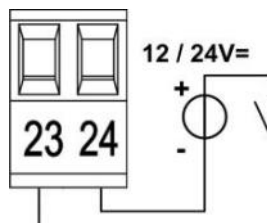
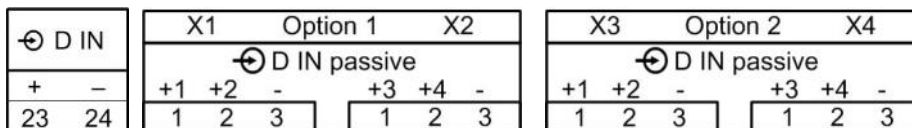

Technical data

Input current	< 7,0 mA
Logical ZERO	- 3 up to + 5 V
Logical ONE	8 up to 30 V

Active inputs (no external power supply required)

X1			Option 1			X2					
⊖ D IN active (S0)											
-1	-2	+				-3	-4	+			
1	2	3				1	2	3			

X3			Option 2			X4					
⊖ D IN active (S0)											
-1	-2	+				-3	-4	+			
1	2	3				1	2	3			

Example with meter pulse and status inputs

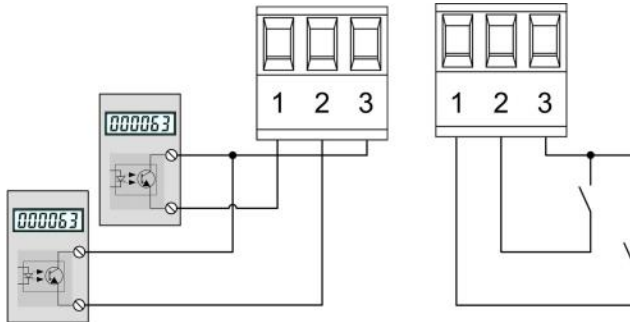

Technical data

acc. EN62053-31, class B

Open circuit voltage ≤ 15 V

Short circuit current < 15 mA

Current at R_{ON}=800Ω ≥ 2 mA

5.9 Digital outputs

The device has two standard digital outputs for which an external 12 / 24 VDC power supply is required.



The power supply shall not exceed 30V DC!

⊖ D OUT 1		⊖ D OUT 2	
+	-	+	-
19	20	21	22

Usage as digital output

- ▶ Alarm output
- ▶ State reporting
- ▶ Pulse output to an external counter (acc. EN62053-31)
- ▶ Remote controlled output

1) Recommended if input impedance of counter > 100 kΩ

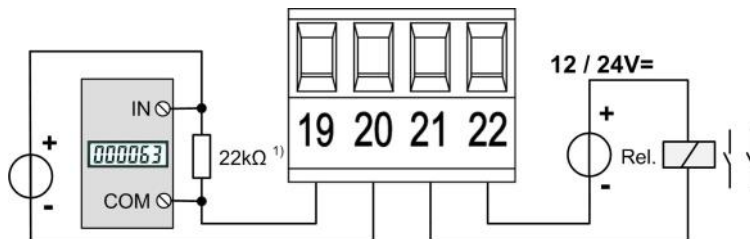

Driving a counter mechanism

The width of the energy pulses can be selected within a range of 30 up to 250ms, but have to be adapted to the external counter mechanism.

Electro mechanical meters typically need a pulse width of 50...100ms.

Electronic meters are partly capable to detect pulses in the kHz range. There are two types: NPN (active negative edge) and PNP (active positive edge). For this device a PNP is required. The pulse width has to be ≥ 30ms (acc. EN62053-31). The delay between two pulses has to be at least the pulse width. The smaller the pulse width, the higher the sensitivity to disturbances.

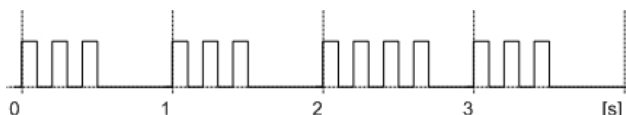

Driving a relay

Rated current 50 mA (60 mA max.)

Switching frequency (S0) ≤ 20 Hz

Leakage current 0,01 mA

Voltage drop < 3 V

5.10 Analog outputs

Analog outputs are available for devices with corresponding I/O extensions only. See nameplate. Analog outputs may be remote controlled.

X1			Option 1			X2		
			±0...20mA					
+4	+3	-	+2	+1	-			
1	2	3	1	2	3			

X3			Option 2			X4		
			±0...20mA					
+4	+3	-	+2	+1	-			
1	2	3	1	2	3			

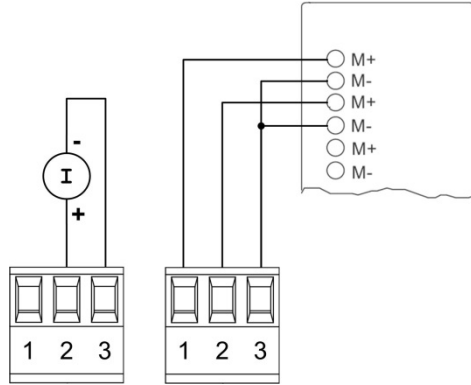

Connection to an analog input card of a PLC or a control system

The device is an isolated measurement device. The module outputs are galvanically connected, but the modules isolated from each other. To reduce the influence of disturbances shielded twisted-pair cables should be used. The shield should be connected to earth on both opposite ends. If there are potential differences between the ends of the cable the shield should be earthed on one side only to prevent from equalizing currents.

Under all circumstances consider as well appropriate remarks in the instruction manual of the system to connect.

5.11 Modbus interface RS485

Via the optional Modbus interface measurement data may be provided for a superior system. However, the Modbus interface cannot be used for device parameterization.

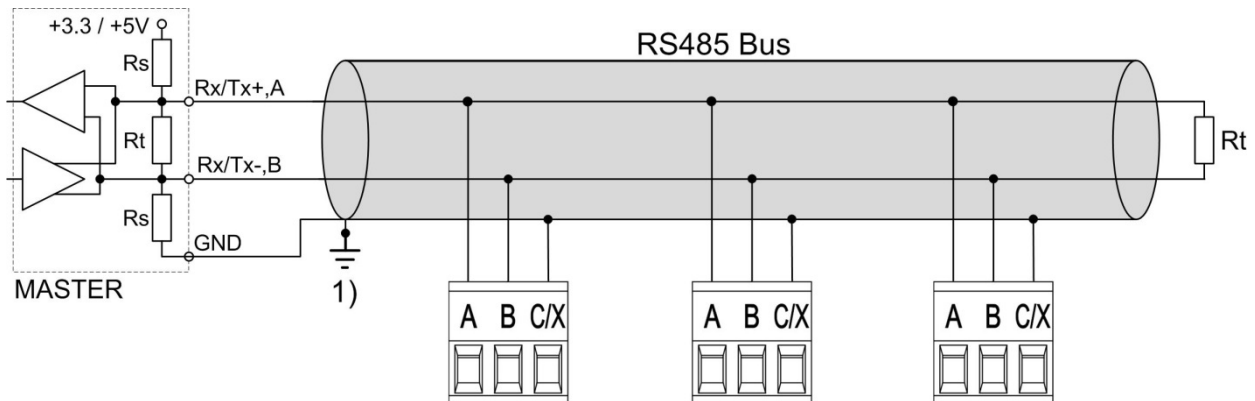

1) One ground connection only.
This is possibly made within the master (PC).

Rt: Termination resistors: 120 Ω each
for long cables (> approx. 10 m)

Rs: Bus supply resistors,
390 Ω each

The signal wires (A, B) have to be twisted. GND (C/X) can be connected via a wire or via the cable shield. In disturbed environments shielded cables must be used. Supply resistors (Rs) have to be present in bus master (PC) interface. Stubs should be avoided when connecting the devices. A pure line network is ideal. You may connect up to 32 Modbus devices to the bus. A proper operation requires that all devices connected to the bus have equal communication settings (baud rate, transmission format) and unique Modbus addresses.

The bus system is operated half duplex and may be extended to a maximum length of 1200 m without repeater.

5.12 Fault current detection

Each fault current module provides **two channels** for monitoring differential or fault currents in earthed AC current systems. In any case, measurement has to be performed via suitable current transformers, a direct measurement is not possible. The module is not suited for monitoring operating currents of normally live conductors (L1, L2, L3, N).

Measurement ranges

Each channel provides two measurement ranges:

a) Measurement range 1A

- Application: Direct measurement of a fault or earth wire current
- Meas. transformer: Current transformer 1/1 up to 1000/1A; 0.2 up to 1.5VA;
Instrument security factor FS5

b) Measurement range 2mA

- Application: Residual current monitoring (RCM)
- Meas. transformer: Residual current transformer 500/1 up to 1000/1A
Rated burden 100 Ω / 0.025 VA up to 200 Ω / 0.06 VA



Use only transformers intended for this application, according to our current transformer catalog, or transformers that fulfill the above specification. Using transformers with divergent specifications may damage the measurement inputs.

Connection

X1	Option 1			X2
	⊖ I > (50/60 Hz)			
	1A	2mA	C	1A 2mA C
1	1	2	3	2 1 2 3

X3	Option 2			X4
	⊖ I > (50/60 Hz)			
	1A	2mA	C	1A 2mA C
1	1	2	3	2 1 2 3



The current transformers including the conductor isolation must guarantee in total a reinforced or double insulation between the mains circuit connected on the primary side and the measuring inputs of the device.



Only one measurement range may be connected per measuring channel!



The COM connectors of both measurement channels are internally connected.



For 2mA inputs a connection monitoring (breakage) is implemented. An alarm state is signaled for the respective measurement channels if either the current transformer is disconnected or the connection to the transformer is interrupted.

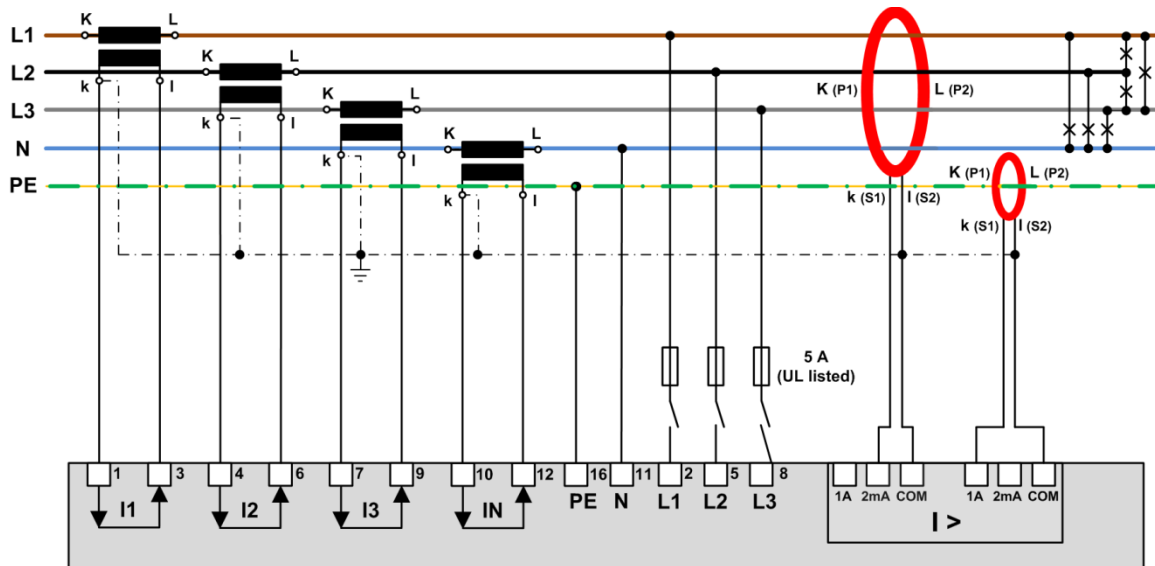

Example: Fault current monitoring in a TNS system

Hints

- (1) If the current transformers for the fault current detection needs to be grounded on the secondary side this has to be done via the COM connector.
- (2) Note that all conductors have to pass through the opening of the residual current transformer in the same direction.
- (3) A possible fault current flows through the protective earth conductor (PE). It can only be detected if the PE conductor is *not* routed through the residual current transformer. If this cannot be avoided, e.g. due to using a multi-wire cable with all conductors, the PE conductor must be returned through the transformer.
- (4) The cable or individual conductors should be routed through the transformer as centered as possible in order to minimize measurement errors.
- (5) Neither the current transformers nor the measurement leads should be mounted or installed close to strong magnetic fields. Measurement lines should also not be laid in parallel to power lines.
- (6) *For measurement range 1A only:* The rated output of the transformer must be chosen that it is reached when the rated secondary current (1A) flows. Consider that the burden of the transformer is not only made up by the burden of the measurement input, but also by the resistance of the measurement lines and the self-consumption of the transformer (copper losses).
 - A rated output selected too low leads to saturation losses in the transformer. The secondary rated current can no longer be reached as the transformer reaches its limits before.
 - A rated output selected too high or an exceeding instrument security factor (>FS5) may cause damage to the measuring inputs in case of overload.
- (7) For the connection of the transformer to the fault detection module use ...
 - Conductor cross sections of 1.0 up to 2.5mm² (16-14 AWG)
 - Pairwise twisted conductors in case of short cable lengths
 - Shielded cables (shield grounded on one side only) in disturbed environment or in case of long cable lengths

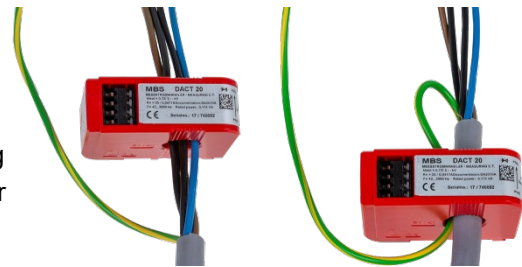

5.13 Temperature inputs

Each temperature module provides **two channels** for temperature monitoring. They can be used in two ways:

a) Temperature measurement via Pt100 sensor

- Measurement range: -50 up to 250°C
- 2 configurable alarm limits
- Configurable alarm delay time for ON / OFF
- Short circuit and wire / sensor breakage monitoring

b) Temperature monitoring with PTC sensors

- Monitoring the PTC response temperature
- Short circuit monitoring
- Serial connection of up to 6 single sensors or up to 2 triplet sensors

Connection

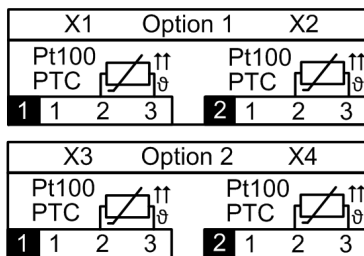

5.14 Uninterruptible power supply (UPS)

The [battery pack](#) for the uninterruptible power supply is supplied separately. Please note that compared to the storage temperature range of the base unit the [storage temperature range](#) of the battery pack is restricted.

Ensure that devices with uninterruptible power supply are used in an environment in accordance with the [specification](#). Outside this operating temperature range, it is not ensured that the battery pack is recharged.

Due to aging the capacity of the battery decreases. To ensure a successful operation of the device during power interruptions the battery needs to be replaced every 3 up to 5 years.



Potential for Fire or Burning. Do not disassemble, crush, heat or burn the removed battery pack.

Replace battery pack with a [battery pack of the same type](#) only. Use of another battery may present a risk of fire or explosion.

5.15 GPS time synchronization

The optional GPS connection module serves for connecting a GPS receiver as a very accurate time synchronization source for the measurement device. The GPS receiver, available as an accessory, is used as outdoor antenna to process data from multiple GPS satellites simultaneously.

GPS receiver

Only use the receiver **Garmin GPS 16x-LVS** (article no. 181'131), offered as an accessory. This device is preconfigured by us and provides the required time information (sentences) without further configuration effort.

- Protection: IPx7 (waterproof)
- Operating temperature: -30...80°C
- Storage temperature: -40...80°C
- 1Hz pulse accuracy: 1µs
- Connector: RJ45



Choosing a mounting location

For a correct operation the GPS receiver requires data from at least 3 satellites at the same time. Therefore position the receiver so that the clearest possible view of the sky and horizon in all direction is obtained. This can be on the roof of a building, at best without reception being restricted by other buildings or obstacles. Avoid mounting the receiver next to large areas of conductible material, as this may cause poor signal reception. It should be also not closer than 1 meter away from any other antenna.



If lightning protection is required, this must be provided by the user.

Mounting the GPS receiver

- The GPS receiver **Garmin GPS 16x-LVS** can be flush mounted by means of 3 M4 screws.
- 120° distribution over a circle of $\varnothing 71.6\text{mm}$
- Thread length max. 8mm. Using longer screws may damage the GPS receiver.

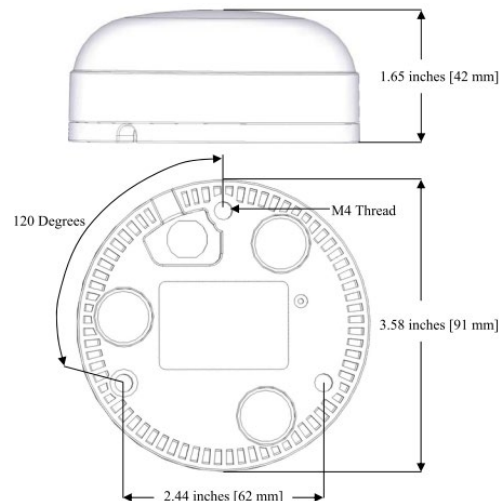

Connecting the GPS receiver



Never connect the RJ45 connector of the connecting cable directly to a network device such as a router or switch. These devices could be damaged.

The GPS receiver is plugged directly into the GPS connection module. The connection cable has a length of 5 m. It may be extended using an RJ45 coupling and an Ethernet cable. The connection cable should not be laid in parallel to live conductors. Twisting or sharp kinking of the cable should be avoided.

Commissioning

- In the settings menu change time synchronization to „NTP server / GPS“
- Check the time synchronization status

> Service > Device information > Device state

Min/max values reset	Device version
Meter contents set/reset	Device license
Operating hours	Device state
Device information	
Factory reset	
Firmware update	
Communication Tests	
Device reboot	

```
Interfaces -----
1) eth0
MAC:          00:12:34:1A:00:05
State:        Up
Link:         Yes
Speed:        100Mb/s
IP address:   192.168.62.142   [static]
Broadcast addr.: 192.168.63.255 [static]
Subnet mask:  255.255.248.0   [static]
Gateway addr.: 192.168.56.4   [static]

Name servers -----
DNS server 1: 192.168.56.55   [static]

Time sources -----
Source 1:     pool.ntp.org
Source 2:     Local clock
Source 3:     GPS

Time Synchronisation -----
synchronised to GPS at stratum 1
time correct to within 1 ms
polling server every 16 s

GPS Status -----
Number of satellites: 04
GPS quality: Differential fix
```

- The time synchronization can be restarted by switching the time synchronization off and on again.
- Time synchronization via GPS and NTP server may work in parallel. If both synchronization sources are available, the system uses the more accurate time source, which is normally GPS.



When connecting a GPS receiver for the first time or when it has been out of operation for a long time, it may take up to 1 hour for finding enough satellites for GPS receiver operation and thus for a reliable time synchronization.

6. Commissioning



Before commissioning you have to check if the connection data of the device match the data of the plant (see nameplates).

If so, you can start to put the device into operation by switching on the power supply and the measurement inputs.

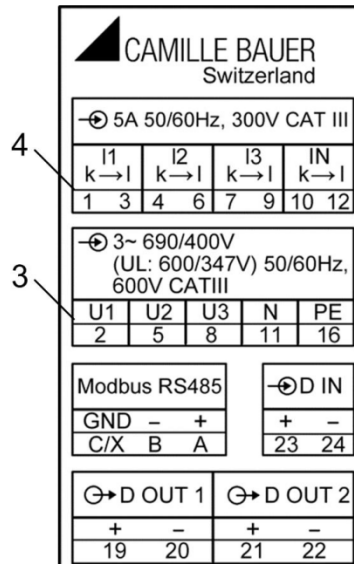
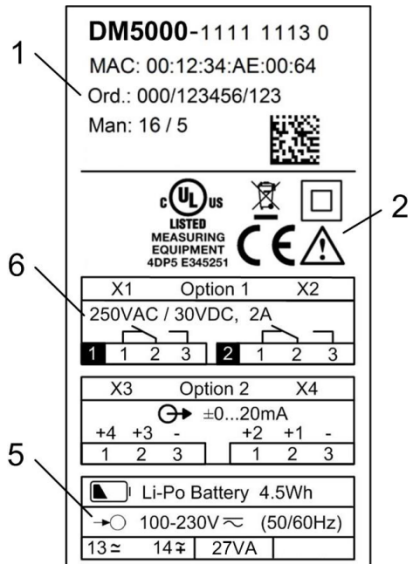

Measurement input

Input voltage
Input current
System frequency

- 1 Serial number
- 2 Test and conformity marks
- 3 Assignment voltage inputs
- 4 Assignment current inputs
- 5 Assignment power supply
- 6 Load capacity relay outputs

6.1 Operating LED



The operating LED shows the present device state.

Procedure	LED display
Booting of device	<ul style="list-style-type: none"> Flashes green (1 Hz) If successful: Change to static green display
Firmware update	<ul style="list-style-type: none"> Change to update mode: Static red During update: Flashes red (1 Hz) If successful or cancelled: Booting of device
Factory reset or reset of communication settings	<ul style="list-style-type: none"> During reset: Flashes red (1 Hz) Then: Booting of device

6.2 Parametrization of the device functionality

A full parameterization of all functions of the device is possible directly at the device (for devices with display) or via web browser. This assumes that user has the required access rights.

For security reasons, the security features “Users and Permissions” (RBAC) and “Web security” (HTTPS) may be activated. In this case, before the device webpage can be displayed using https, you have to [install a root certificate](#), which is provided via our homepage. Once the certificate is downloaded to the local computer the certificate can be installed manually. Just double-click on the file, and install the certificate as a trusted root certification authority.

See: [Configuration \(7.5\)](#)

6.3 Installation check

The correct connection of the current and voltage inputs can be checked in two ways.

- a) **Sense of rotation check:** Using the sequence of the current and voltage phasors the sense of rotation is determined and compared to the configured one. The phase rotation indicator is arranged in the menu “Phasor diagram”.

Test requirement: Magnitude of all connected voltages at least 5% of nominal, magnitude of all connected currents at least 0.2% of nominal.



Possible results



Correct sense of rotation







Wrong sense of rotation

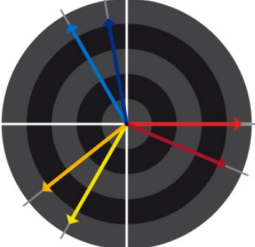

Missing phase or magnitude too small

b) **Phasor verification:** The phasor diagram shows a technical visualization of the current and voltage phasors, using a counter-clockwise rotation, independent of the real sense of rotation.

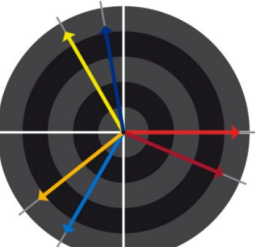
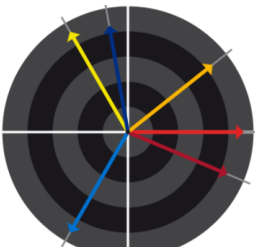
i The diagram is always built basing on the voltage of the reference channel (direction 3 o'clock)

 <p style="text-align: center;">50V/div 20A/div</p>	<table border="1" style="width: 100%; border-collapse: collapse;"> <thead> <tr> <th>L1</th> <th>L2</th> <th>L3</th> <th></th> </tr> </thead> <tbody> <tr> <td>230.60</td> <td>230.64</td> <td>230.54</td> <td>V</td> </tr> <tr> <td>0.00</td> <td>-119.97</td> <td>120.03</td> <td>*</td> </tr> <tr> <td>85.97</td> <td>86.03</td> <td>85.86</td> <td>A</td> </tr> <tr> <td>-22.9</td> <td>-21.7</td> <td>-20.0</td> <td>*</td> </tr> <tr> <td>0.921</td> <td>0.929</td> <td>0.940</td> <td>PF</td> </tr> </tbody> </table>	L1	L2	L3		230.60	230.64	230.54	V	0.00	-119.97	120.03	*	85.97	86.03	85.86	A	-22.9	-21.7	-20.0	*	0.921	0.929	0.940	PF	<p>Correct installation (expectation)</p> <ul style="list-style-type: none"> Voltage sequence in clock-wise order: L1 → L2 → L3 ($0^\circ \rightarrow -120^\circ \rightarrow 120^\circ$) Current sequence in clock-wise order: L1 → L2 → L3 Similar angle between voltage and current phasors in all phases (approx. -20°)
L1	L2	L3																								
230.60	230.64	230.54	V																							
0.00	-119.97	120.03	*																							
85.97	86.03	85.86	A																							
-22.9	-21.7	-20.0	*																							
0.921	0.929	0.940	PF																							
 <p style="text-align: center;">50V/div 20A/div</p>	<table border="1" style="width: 100%; border-collapse: collapse;"> <thead> <tr> <th>L1</th> <th>L2</th> <th>L3</th> <th></th> </tr> </thead> <tbody> <tr> <td>230.58</td> <td>230.63</td> <td>230.53</td> <td>V</td> </tr> <tr> <td>0.00</td> <td>-119.97</td> <td>120.03</td> <td>*</td> </tr> <tr> <td>85.96</td> <td>86.04</td> <td>85.87</td> <td>A</td> </tr> <tr> <td>-22.9</td> <td>158.4</td> <td>-20.0</td> <td>*</td> </tr> <tr> <td>0.921</td> <td>-0.930</td> <td>0.940</td> <td>PF</td> </tr> </tbody> </table>	L1	L2	L3		230.58	230.63	230.53	V	0.00	-119.97	120.03	*	85.96	86.04	85.87	A	-22.9	158.4	-20.0	*	0.921	-0.930	0.940	PF	<p>What's wrong?</p> <ul style="list-style-type: none"> Voltage sequence: L1 → L2 → L3 Current sequence: L1 → L3 → L2; Current L2 is out of the expected sequence Angle U-I: Angle between U_{L2} and I_{L2} is approx. 180° wrong <p>Required correction Reversing the polarity of current I_2</p>
L1	L2	L3																								
230.58	230.63	230.53	V																							
0.00	-119.97	120.03	*																							
85.96	86.04	85.87	A																							
-22.9	158.4	-20.0	*																							
0.921	-0.930	0.940	PF																							
 <p style="text-align: center;">50V/div 20A/div</p>	<table border="1" style="width: 100%; border-collapse: collapse;"> <thead> <tr> <th>L1</th> <th>L2</th> <th>L3</th> <th></th> </tr> </thead> <tbody> <tr> <td>230.59</td> <td>230.49</td> <td>230.70</td> <td>V</td> </tr> <tr> <td>0.00</td> <td>120.04</td> <td>-119.99</td> <td>*</td> </tr> <tr> <td>85.97</td> <td>86.02</td> <td>85.86</td> <td>A</td> </tr> <tr> <td>-22.9</td> <td>98.3</td> <td>-140.0</td> <td>*</td> </tr> <tr> <td>0.921</td> <td>-0.145</td> <td>-0.766</td> <td>PF</td> </tr> </tbody> </table>	L1	L2	L3		230.59	230.49	230.70	V	0.00	120.04	-119.99	*	85.97	86.02	85.86	A	-22.9	98.3	-140.0	*	0.921	-0.145	-0.766	PF	<p>What's wrong?</p> <ul style="list-style-type: none"> Voltage sequence: L1 → L3 → L2; L3 and L2 seems to be interchanged Current sequence: L1 → L2 → L3 Angle U-I: Angles between U_{L2} / I_{L2} and U_{L3} / I_{L3} do not correspond to the expectations <p>Required correction Exchanging the connections of the voltages L2 and L3</p>
L1	L2	L3																								
230.59	230.49	230.70	V																							
0.00	120.04	-119.99	*																							
85.97	86.02	85.86	A																							
-22.9	98.3	-140.0	*																							
0.921	-0.145	-0.766	PF																							
 <p style="text-align: center;">50V/div 20A/div</p>	<table border="1" style="width: 100%; border-collapse: collapse;"> <thead> <tr> <th>L1</th> <th>L2</th> <th>L3</th> <th></th> </tr> </thead> <tbody> <tr> <td>230.58</td> <td>230.49</td> <td>230.68</td> <td>V</td> </tr> <tr> <td>0.00</td> <td>120.04</td> <td>-119.99</td> <td>*</td> </tr> <tr> <td>85.97</td> <td>86.04</td> <td>85.86</td> <td>A</td> </tr> <tr> <td>-22.9</td> <td>-81.6</td> <td>-140.0</td> <td>*</td> </tr> <tr> <td>0.921</td> <td>0.145</td> <td>-0.766</td> <td>PF</td> </tr> </tbody> </table>	L1	L2	L3		230.58	230.49	230.68	V	0.00	120.04	-119.99	*	85.97	86.04	85.86	A	-22.9	-81.6	-140.0	*	0.921	0.145	-0.766	PF	<p>What's wrong?</p> <ul style="list-style-type: none"> Voltage sequence: L1 → L3 → L2; L3 and L2 seems to be exchanged Current sequence: L1 → L3 → L2; Current L2 is out of the expected sequence Angle U-I: Angles between U_{L2} / I_{L2} and U_{L3} / I_{L3} do not correspond to the expectations <p>Required correction Exchanging the connections of the voltages L2 and L3 and reversing the polarity of the current input I_2</p>
L1	L2	L3																								
230.58	230.49	230.68	V																							
0.00	120.04	-119.99	*																							
85.97	86.04	85.86	A																							
-22.9	-81.6	-140.0	*																							
0.921	0.145	-0.766	PF																							
 <p style="text-align: center;">50V/div 20A/div</p>	<table border="1" style="width: 100%; border-collapse: collapse;"> <thead> <tr> <th>L1</th> <th>L2</th> <th>L3</th> <th></th> </tr> </thead> <tbody> <tr> <td>230.45</td> <td>230.48</td> <td>230.58</td> <td>V</td> </tr> <tr> <td>0.00</td> <td>-120.02</td> <td>119.98</td> <td>*</td> </tr> <tr> <td>85.96</td> <td>86.00</td> <td>85.86</td> <td>A</td> </tr> <tr> <td>-143.0</td> <td>-141.6</td> <td>-140.0</td> <td>*</td> </tr> <tr> <td>-0.798</td> <td>-0.784</td> <td>-0.766</td> <td>PF</td> </tr> </tbody> </table>	L1	L2	L3		230.45	230.48	230.58	V	0.00	-120.02	119.98	*	85.96	86.00	85.86	A	-143.0	-141.6	-140.0	*	-0.798	-0.784	-0.766	PF	<p>What's wrong?</p> <ul style="list-style-type: none"> Voltage sequence: L1 → L2 → L3 Current sequence: L3 → L1 → L2 Angle U-I: The U-I angles do not correspond to the expectation, but are similar <p>Required correction Cyclical exchange of the voltage connections: $L1 \rightarrow L3, L2 \rightarrow L1, L3 \rightarrow L2$. As an alternative the sequence of all currents may be changed as well (more effort required).</p>
L1	L2	L3																								
230.45	230.48	230.58	V																							
0.00	-120.02	119.98	*																							
85.96	86.00	85.86	A																							
-143.0	-141.6	-140.0	*																							
-0.798	-0.784	-0.766	PF																							

6.4 Ethernet installation

6.4.1 Settings

Before devices can be connected to an existing Ethernet network, you have to ensure that they will not disturb the normal network service. The rule is:



None of the devices to connect is allowed to have the same IPv4/v6 address than another device already installed

The device supports both IPv4 and IPv6 communication. IPv4 communication is activated by default; IPv6 can be activated additionally via configuration.

IPv4 communication

Depending on the device version, there may be multiple Ethernet interfaces with different default IPv4 addresses.

Interface	Application	Default IPv4	Settings via menu
Standard	Configuration / Modbus TCP	192.168.1.101	Settings Communication Ethernet
IEC 61850	IEC61850 communication	192.168.1.111	Settings IEC61850 Ethernet
PROFINET	PROFINET communication	0.0.0.0	(exclusively via control system)

IPv6 communication

Depending on the device version, there may be multiple Ethernet interfaces with different default IPv6 addresses, once the IPv6 communication is activated.

Interface	Application	Default IPv6	Settings via menu
Standard	Configuration / Modbus TCP	fd2d:bb44:97f1:3976::1	Settings Communication Ethernet
IEC 61850	IEC61850 communication	fd2d:bb44:97f1:3976::B	Settings IEC61850 Ethernet
PROFINET	PROFINET communication	0::0	(exclusively via control system)

Network settings (Communication | Ethernet)

The following settings have to be arranged with the network administrator:

• IPv4/6: IP address	Must be unique , i.e. may be assigned in the network only once
• IPv4: Subnet mask	Defines how many devices are directly addressable in the IPv4 network. This setting is equal for all the devices. Examples
• IPv4/6: Gateway address	Is used to resolve addresses during communication between different networks. It should contain a valid address within the directly addressable network
• IPv4/6: DNS-Server x	Is used to resolve a domain name into an address, if e.g. a name (pool.ntp.org) is used for the NTP server. Further information
• IPv6: Prefix length	Is comparable to the subnet mask in IPv4 networks; it is the number of the leftmost bits of the site prefix which need to be identical for direct communication.
• Hostname	Individual designation for each device. Via the hostname the device can be uniquely identified in the network. Therefore for each device a unique name should be assigned.
• NTP-Server x	NTP servers are used as base for time synchronization
• Modbus TCP enabled	If Modbus/TCP communication is not required it may be disabled for security reasons.
• Modbus/TCP port	Selection of the TCP port to be used for Modbus/TCP communication. Standard setting is 502. See also TCP ports .

IPv4: Mode	Static
IPv4: IP address	192.168.62.25
Subnet mask	255.255.248.0
IPv4: Gateway address	192.168.56.5
IPv4: DNS server 1	192.168.56.55
IPv4: DNS server 2	192.168.56.155
IPv6: Mode	Static
IPv6: IP address	fd2d:bb44:97f1:3976::3
IPv6: Prefix length	64
IPv6: Gateway address	fd2d:bb44:97f1:3976::5:1
IPv6: DNS server 1	
IPv6: DNS server 2	
Host name	PQ5000Exxxxx
Clock synchronization	NTP server / GPS
NTP server 1	pool.ntp.org
NTP server 2	
Modbus TCP enabled	yes
Modbus TCP port	502

Network settings of Standard interface

IP address	192.168.62.103
Subnet mask	255.255.248.0
Gateway address	192.168.56.5
DNS server 1	192.168.56.55
DNS server 2	192.168.56.155
Host name	PQ5000-IEC61850-RR
Clock synchronization	NTP server
NTP server 1	pool.ntp.org
NTP server 2	

Network settings of IEC61850 interface

IPv4: Subnet mask

For a direct communication between device and PC both devices need to be in the same network when the subnet mask is applied:

Example 1	decimal	binary
IP address	192.168. 1.101	11000000 10101000 00000001 01100101
Subnet mask	255.255.255.224	11111111 11111111 11111111 11100000
	variable range	xxxxxx
First address	192.168. 1. 96	11000000 10101000 00000001 01100000
Last address	192.168. 1.127	11000000 10101000 00000001 01111111

► The device 192.168.1.101 can access directly the devices 192.168.1.96 ... 192.168.1.127

Example 2	decimal	binary
IP address	192.168. 57. 64	11000000 10101000 00111001 01000000
Subnet mask	255.255.252. 0	11111111 11111111 11111100 00000000
	variable range	xx xxxxxxxx
First address	192.168. 56. 0	11000000 10101000 00111000 00000000
Last address	192.168. 59.255	11000000 10101000 00111011 11111111

► The device 192.168.57.64 can access directly the devices 192.168.56.0 ... 192.168.59.255

IPv4: Mode >> DHCP

If a DHCP server is available, alternatively the mode „**DHCP**“ or „**DHCP, addresses only**“ can be selected for the Standard interface. The device then gets all necessary information from the DHCP server. The difference between the two modes is that for “DHCP” also the DNS server address is obtained.

The settings obtained from the DHCP server can be retrieved locally via the service menu.

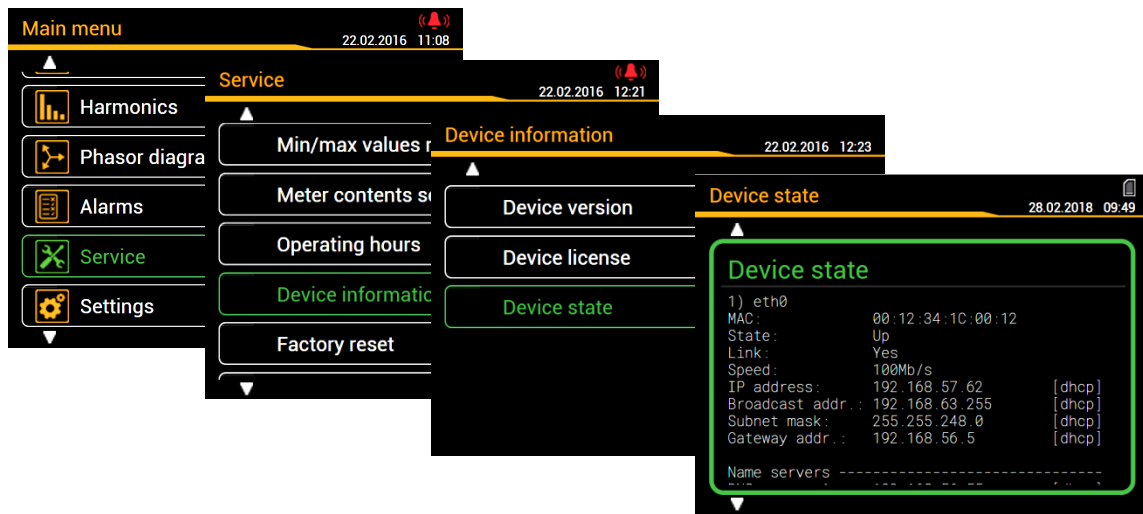

Depending on the settings of the DHCP server the provided IP address can change on each reboot of the device. Thus it's recommended to use the DHCP mode during commissioning only.

Time synchronization via NTP protocol

For the *time synchronization* of devices via Ethernet *NTP* (Network Time Protocol) is the standard. Corresponding time servers are used in computer networks, but are also available for free via Internet. Using NTP it's possible to hold all devices on a common time base.

Two different NTP servers may be defined. If the first server is not available the second server is used for trying to synchronize the time.

If a public NTP server is used, e.g. “pool.ntp.org”, a name resolution is required. This normally happens via a **DNS server**. So, the IP address of the DNS server must be set in the communication settings of the Ethernet interface to make a communication with the NTP server, and thus time synchronization, possible. Your network administrator can provide you the necessary information.

The time synchronization of the Standard interface can be performed via a [GPS receiver](#) as well.

TCP ports

The TCP communication is done via so-called ports. The number of the used port allows determining the type of communication. As a standard Modbus/TCP communication is performed via TCP port 502, NTP uses port 123. However, the port for the Modbus/TCP communication may be modified. You may provide a unique port to each of the devices, e.g. 503, 504, 505 etc., for an easier analysis of the communication traffic. Independent of these setting a communication via port 502 is always supported. The device allows at least 5 connections to different clients at the same time.

Firewall

Due to security reasons nowadays each network is protected by means of a firewall. When configuring the firewall you have to decide which communication is desired and which have to be blocked. The TCP port 502 for the Modbus/TCP communication normally is considered to be unsafe and is often disabled. This may lead to a situation where no communication between networks (e.g. via Internet) is possible.

6.4.2 Connection of the standard interface

The RJ45 connector serves for direct connecting an Ethernet cable.

- Interface: RJ45 socket, Ethernet 100BaseTX
- Mode: 10/100 MBit/s, full / half duplex, Auto-negotiation
- Protocols: http, https, Modbus/TCP, NTP

Functionality of the LED's



- LED left: Switched on as soon as a network connection exists (link)
- LED right: Flashes during communication with the device (activity)

6.4.3 Connection of the IEC61850 interface

The RJ45 sockets X1 and X2 serve for direct connecting Ethernet cables. Both ports are equivalent and internally connected via a switch.

- Interface: RJ45 sockets, Ethernet 100BaseTX
- Mode: 10/100 MBit/s, full / half duplex, Auto-negotiation
- Protocols: IEC61850, NTP

Functionality of the LED's

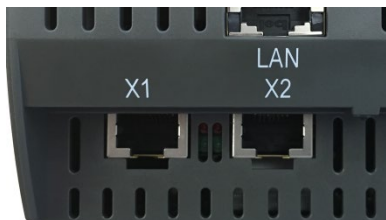

- LED green: On if a network connection (link) exists, flashes during communication

6.4.4 Connection of the PROFINET interface

The RJ45 sockets X1 and X2 serve for direct connecting Ethernet cables. Both ports are equivalent and internally connected via a switch.

Note: The interface may only be connected to a local Profinet network, which is designed as SELV circuit according to IEC 60950-1.

- Interface: RJ45 sockets, Ethernet 100BaseTX
- Mode: 10/100 MBit/s, full / half duplex, auto-negotiation
- Protocols: PROFINET, LLDP, SNMP

Functionality of the LED's

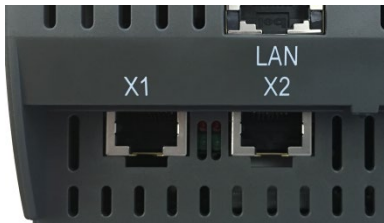

LED	State	Meaning
X1 green X2 green	OFF	No network connection
	ON	Existing network connection
	Flashing	Active communication
Red left BF (Bus failure)	OFF	No error
	ON	No configuration, slow or no link
	Flashing (2 Hz)	No data exchange
Red right SF (System failure)	OFF	No error
	ON	Watchdog timeout, diagnosis active; System failure
	Flashing (1 Hz, 3s)	DCP signal service via bus initiated

6.4.5 MAC addresses

For uniquely identifying Ethernet connections in a network, to each connection a unique MAC address is assigned. Compared to the IP address, which may be modified by the user at any time, the MAC address is statically.

Standard Ethernet interface

DM5000 -1111 0113 0
MAC: 00:12:34:AE:00:64
Ord.: 000/123456/123
Man: 16 / 5 

IEC61850 Ethernet interface

X1	IEC 61850	X2
MAC: 00:12:34:21:00:7C		

PROFINET Ethernet interface

X1	PROFINET	X2
MAC: 00:12:34:22:00:0C		

Typically, for a PROFINET device [3 MAC addresses](#) are required:

- Chassis MAC: as given on the nameplate
- Port connector X1: Chassis MAC + 2
- Port connector X2: Chassis MAC + 1

6.4.6 Communication tests

Via the service menu on the device website you may check if the selected network structure is valid. The device must be able to reach the DNS server via gateway. The DNS server then allows resolving the URL of the NTP server to an IP address. The Standard Ethernet interface serves as interface for the communication tests.

- Ping: Connection test to any network device (initial: gateway address)
- DNS: Test, if the name resolution via DNS works (initial: URL of NTP server)
- NTP: Test, if the selected NTP-Server is in fact a time server (stratum x)
- SFTP: Test, if access to SFTP server works. A test file will be copied to the base directory of the server.

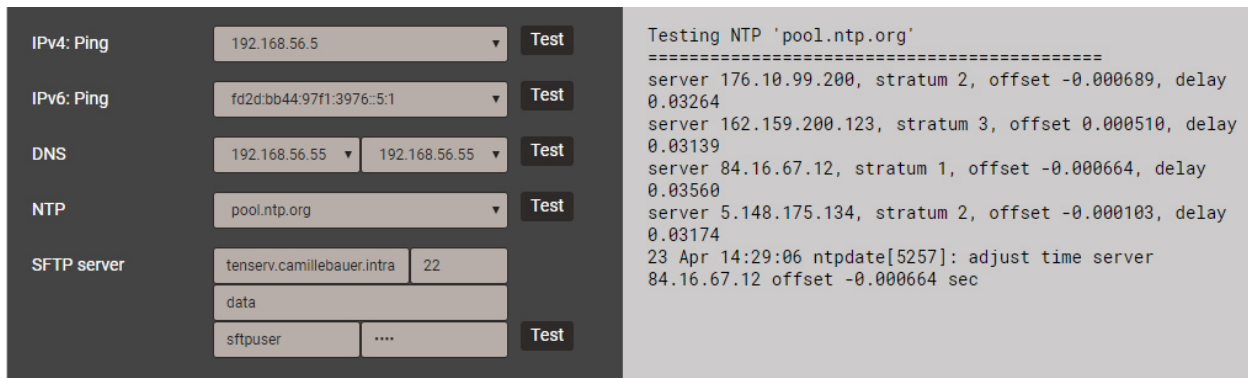

The screenshot shows a web interface for testing network services. On the left, there are configuration fields for IPv4 Ping (192.168.56.5), IPv6 Ping (fd2d:bb44:97f1:3976::5:1), DNS (192.168.56.55), NTP (pool.ntp.org), and SFTP server (tenserv.camillebauer.intra, 22, data, sftpuser). Each field has a 'Test' button. On the right, the test results for NTP are displayed, showing a list of servers with their stratum levels, offsets, and delays. The output includes: 'Testing NTP 'pool.ntp.org'', 'server 176.10.99.200, stratum 2, offset -0.000689, delay 0.03264', 'server 162.159.200.123, stratum 3, offset 0.000510, delay 0.03139', 'server 84.16.67.12, stratum 1, offset -0.000664, delay 0.03560', 'server 5.148.175.134, stratum 2, offset -0.000103, delay 0.03174', and '23 Apr 14:29:06 ntpdate[5257]: adjust time server 84.16.67.12 offset -0.000664 sec'.

NTP server test

6.4.7 Resetting the communication settings



If the communication settings of the Standard interface are no longer known, they can be reset to the default settings by pressing the sunk-in reset button (located below the operating LED) for at least 3s. During the reset the operating LED flashes red. After the reset the device is rebooted.

6.5 IEC 61850 interface

The features of the IEC61850 interface are described in a separate document:

>> IEC61850 interface SINEAX AMx000/DM5000, LINAX PQx000, CENTRAX CUx000

This document is available via:

>> <https://www.camillebauer.com/dm5000-en>

6.6 PROFINET IO interface

The PROFINET interface provides a cyclical process image, which can be freely assembled by the user.

6.6.1 General stations description file (GSD)

The GSD file describes the functionality available via the PROFINET interface of the device. During system design by means of a configuration tool (e.g. TIA or Simatic Step 7 of Siemens) the GSD file serves to implement devices with a minimum effort.

The description language of the GSD file for PROFINET is GSDML (Generic Station Description Markup Language), thus a language independent XML format. Sources for the download of the GSDML file of the device are:

- Homepage: <https://www.camillebauer.com/dm5000-en>
- USB stick with software and documentation, no.156'027 (optional)
- The website of the device itself:

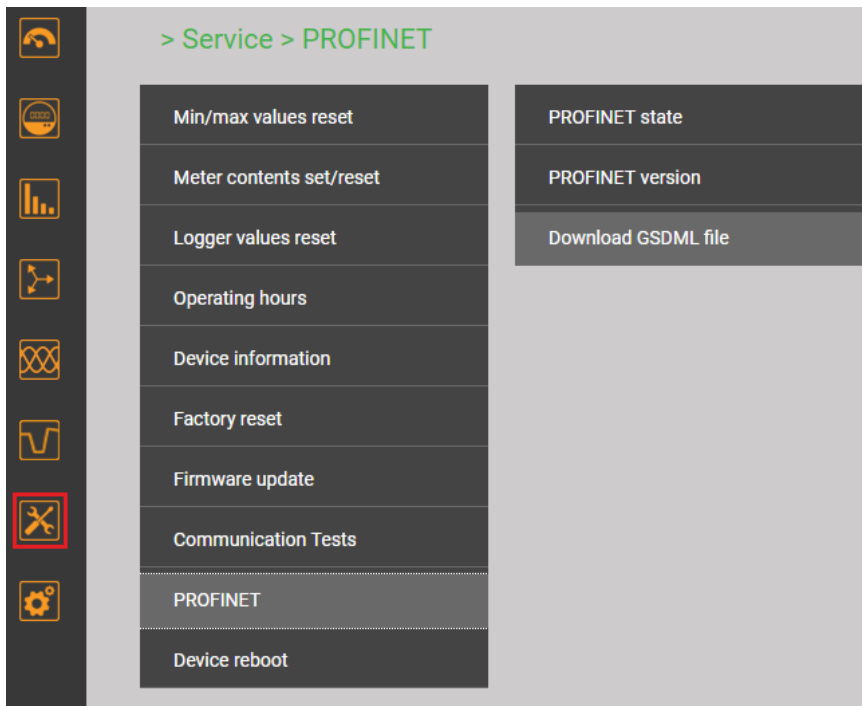

Before a device can be used in a project, the associated GSD file must be imported in the configuration tool (e.g. TIA Portal).

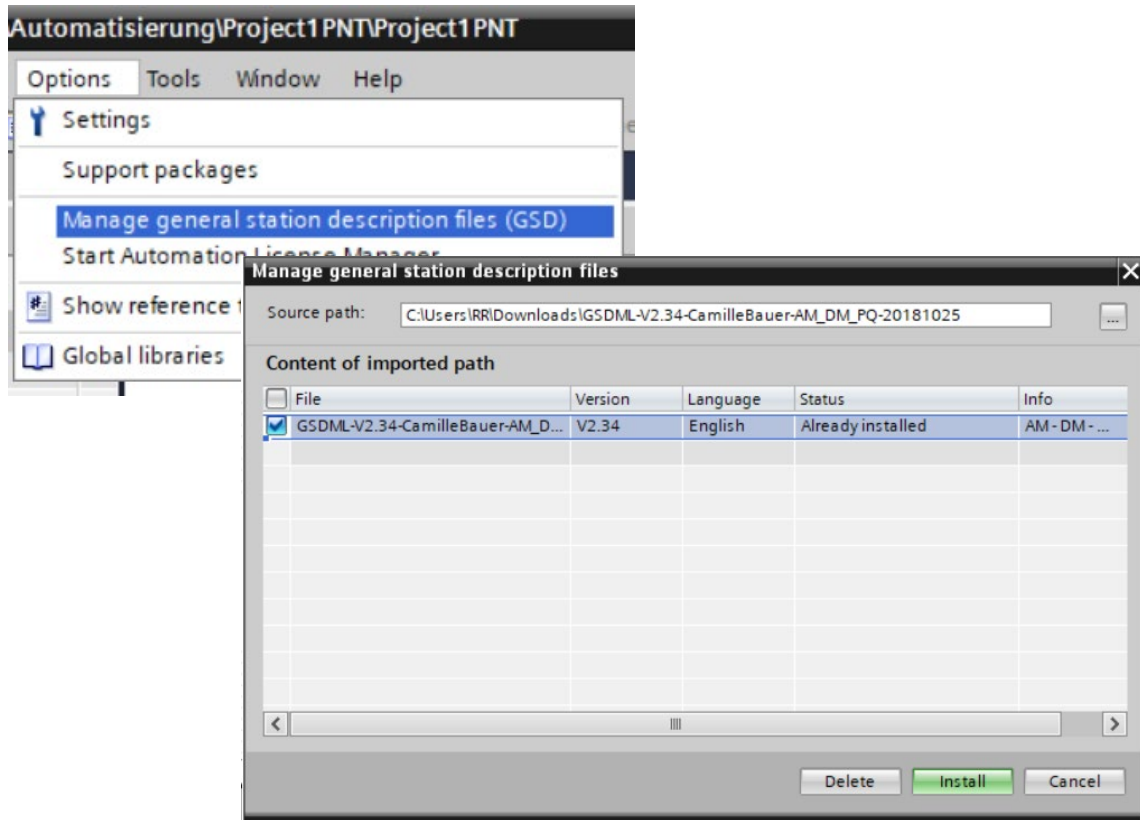

6.6.2 Parameterization of the device

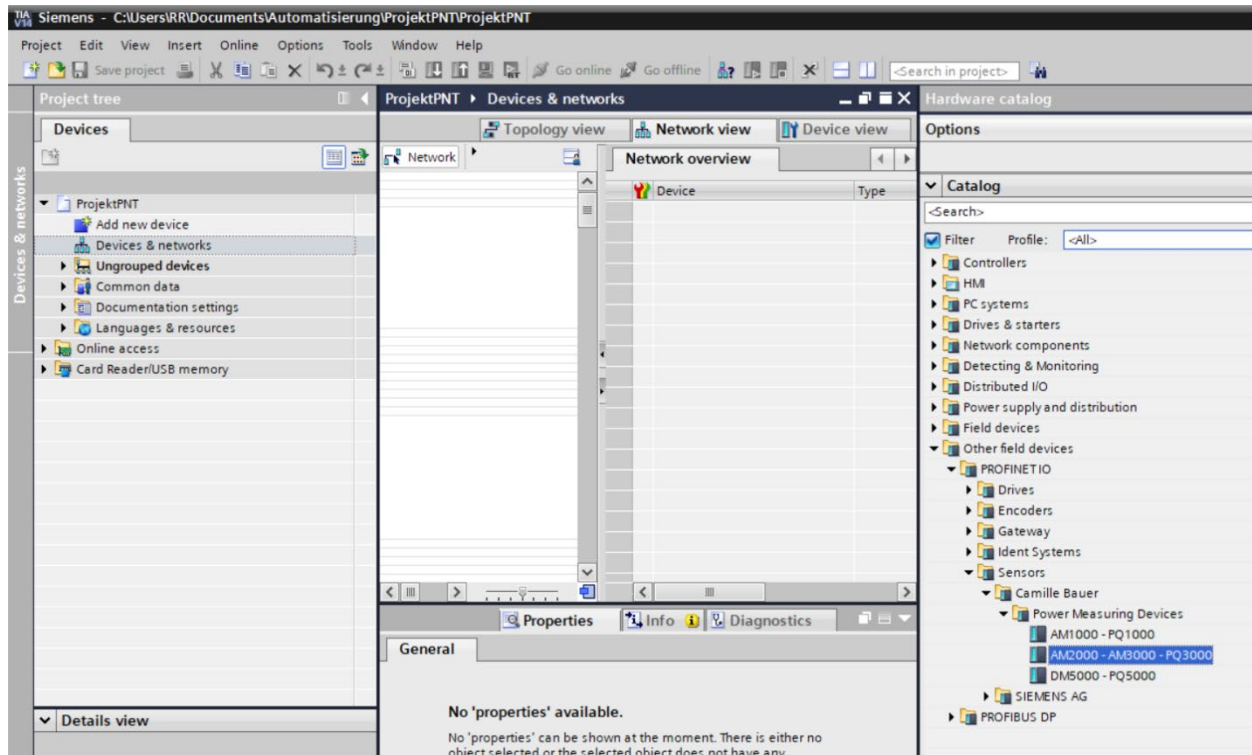

As soon as the GSD file has been imported, the device is available in the hardware catalog and can be integrated using drag&drop. There are three models available that represent the different designs of the whole device series. The selection shown above is for example suited for the devices AM2000, AM300 and PQ3000, which have the same design (panel 144x144mm) and support the same measured values.

Further steps during parameterization are:

- Assigning a unique device name via DCP protocol
- Assigning an IP address to the device, normally an automatic procedure
- Assembly of the cyclical process image (see below), maximum of 62 measurements
- Integration in the topology of the complete system

Because these steps are device independent and do rely on the used tool only, further details are not given here.

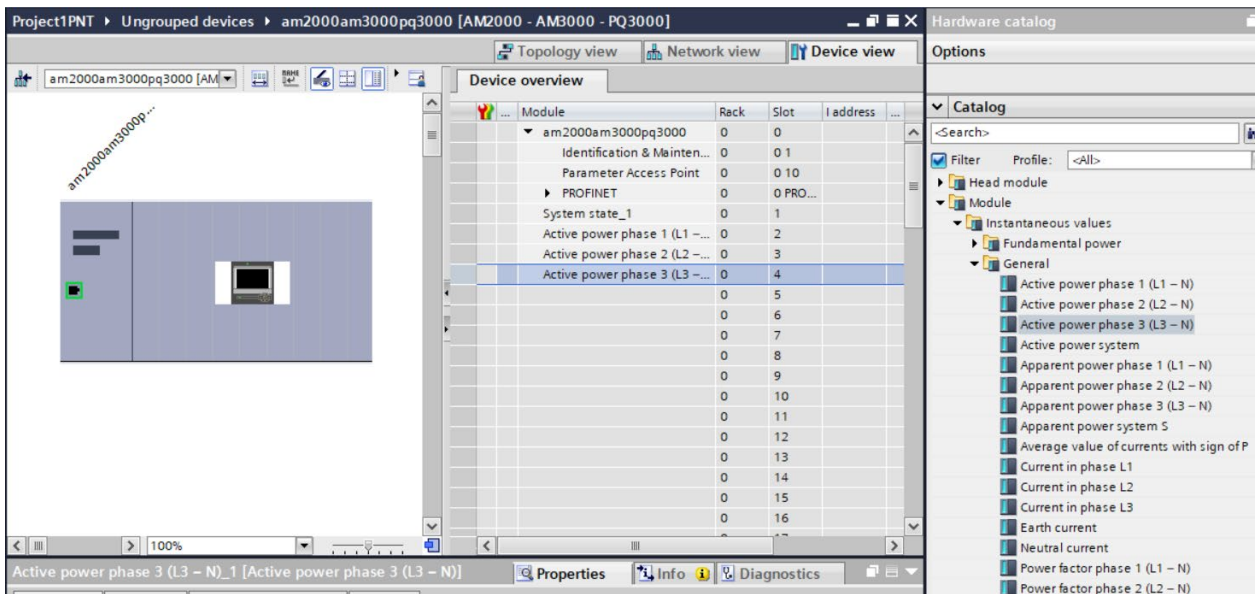

Assembly of the cyclical process image

In Slot 1 always the module 'System state' is present providing the following information:

Bit	Meaning
0	0: Measurement system stopped or not reachable 1: Measurement system running
1	0 ↔ 1: When the measurement system is running, the bit changes its state when the value of at least one of the modules changes
2...31	not used, currently set to 0

Hints

- A parameterization of the base functionality of the device (such as the measurement functionality) via PROFINET is not required
- A local modification of parameters (e.g. IP address, PROFINET device name) is not possible

6.6.3 Validity of measurements

The following measurements can be used in the process image:

- Instantaneous values of voltages, currents, active/reactive/apparent power, frequency, load factor
- THD voltages and currents, TDD currents
- Odd harmonics of voltages and currents up to the 25th
- Symmetrical components and unbalance factors of voltage/current
- Fundamental power, distortion reactive power, $\cos\varphi$, $\tan\varphi$
- Energy meters high and low tariff, pre- and user-defined base quantities
- Mean-values, predefined power quantities and user-defined base quantities



The provided measurements are the sum of all possible values, for all system configuration from single phase up to 4-wire unbalanced. The Modbus device description provides the information about the validity of the measurements with respect to the used system configuration. This description can be downloaded via one of the following sources:

- Homepage: <https://www.camillebauer.com/dm5000-en>
- USB stick with software and documentation, no.156'027 (optional)



If invalid measurements are used in the process image, their values are always zero.

6.6.4 PROFINET state

- For devices with display the present PROFINET state is shown in the status bar:

	Data exchange with IO controller inactive
	Data exchange with IO controller active

- The PROFINET status is always visible in the status bar on the device website:

	Data exchange with IO controller inactive
	Data exchange with IO controller active

- PROFINET related information may be accessed via the menu *Service | PROFINET | PROFINET Status*:

<pre> IO controller ===== Connected: No Device name: IP address: IO device ===== Device name: am3000 Network settings ----- IP address: 192.168.1.201 Subnet mask: 255.255.255.0 Gateway addr.: 192.168.1.1 MAC addresses ----- Chassis: 00:12:34:22:00:09 Port X2: 00:12:34:22:00:0A Port X1: 00:12:34:22:00:0B </pre> <p><i>Data exchange with IO controller inactive</i></p>	<pre> IO controller ===== Connected: Yes Device name: plcx1d0ed IP address: 192.168.1.2 IO device ===== Device name: am3000 Network settings ----- IP address: 192.168.1.201 Subnet mask: 255.255.255.0 Gateway addr.: 192.168.1.1 MAC addresses ----- Chassis: 00:12:34:22:00:09 Port X2: 00:12:34:22:00:0A Port X1: 00:12:34:22:00:0B </pre> <p><i>Data exchange with IO controller active</i></p>
--	--

6.7 Simulation of analog / digital outputs

To check if subsequent circuits will work properly with output values provided by the device, using the service menu **Simulation** all analog or digital / relay outputs may be simulated. This is done by either entering analog output values or selecting discrete states for the digital outputs / relays.

Simulation is possible via webpage and as well via the local display.

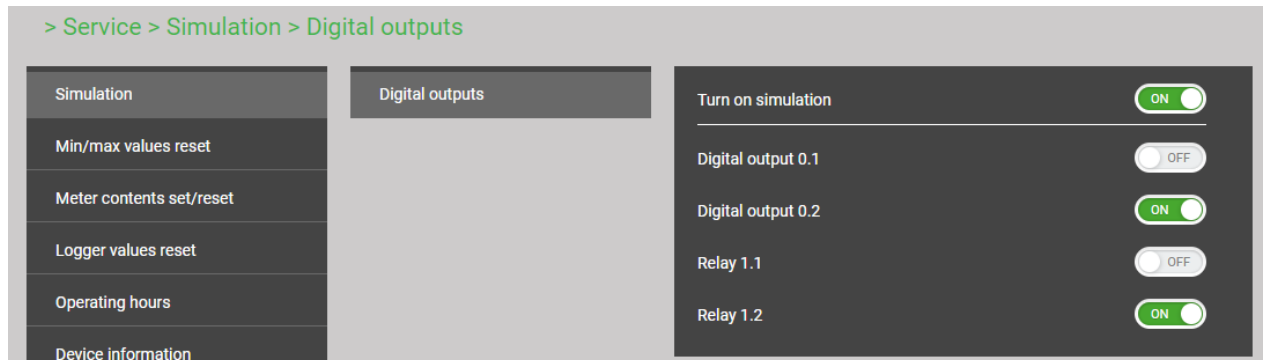

Simulation of digital outputs via device webpage

6.8 Security system

The device provides several security mechanisms, which can be activated to ensure a comprehensive access protection to all device data.



For devices **without data logger** the functionality of the Audit Log is restricted. Respective restrictions are listed in the description of the individual security mechanism.

- The **role-based access control (RBAC)** system allows restricting the access to measured data, configuration settings and service functions to the rights granted to the present user. For access via website or local display this is done by reducing the available menus and / or providing only read access rights to specific services. For accessing data via external applications an API (Application Programming Interface) key is required, which needs to be implemented as a special user.
- **HTTPS** provides encrypted communication using TLS (Transport Layer Security)
- Via **client whitelist** access to the device can be restricted to specific clients with definable IP addresses.
- **Communication blocking:** Communication services, such as Modbus/RTU, Modbus/TCP or SYSLOG are blocked by default and must be actively enabled via configuration. This way unauthorized access may be prevented and possible intruding points eliminated.
- **Security log:** The device stores all security related messages in a separate list accessible via the service menu. The content of this list can also be transferred to a central log-server using the **SYSLOG** protocol for security auditing.

For devices without data logger messages get lost when restarting the device.

If the device is equipped with a display, restrictions defined in the security system also take effect when operating the device via the local display. It is also possible to restrict users to local access only.

6.8.1 RBAC management

Each access to device data via website, local display or external software applications can be comprehensively protected using the role-based access control (RBAC) system. This way, access to measured value information, the change of configuration parameters or the resetting / deletion of measurement data can be individually adapted to the role of the active user.

Note: All settings of the security system are stored in the device in encrypted form only; login credentials are never transmitted in plain text.

A maximum of 8 users is supported

➤ 3 pre-defined standard users

- *admin*: A user with administrator rights (Default setting password: „CBM_1234“)
- *localgui*: The standard user for the local display. Its permissions determine what can be displayed or changed via the built-in display without a user having to log in.
- *anonymous*: The standard user for access via device website. Its permissions determine what can be displayed or changed via the website without a user having to log in.

➤ Up to 5 definable users or API keys

Users or API keys may be created by each user with write access to the settings of the security system. In any case, each user with a web login can change the password of its own account.

Application programming interface (API) keys are used to allow applications to access device data via REST interface (communication via http/https protocol). Such keys are timely unlimited and have either read-only permissions, all permissions or all permissions except security.

The pre-defined administrator or any other user with full access rights to the settings of the security system can:

- Change its own credentials (user name and/or password)
- Change the credentials (user name and/or password) of any other user
- Freely define the permissions of the standard users *localgui* and *anonymous*; both users are standard users without login credentials
- Create new users up to a maximum of 5
- Restrict users to local operation only (no login via website)

The RBAC settings are managed via the menu Settings | Security system | Users and Permissions. To do this, Users and Permissions must be enabled:



Adding users / API keys

In addition to the 3 predefined users a maximum of 5 users or API keys may be created. To do so, use “Add user / API key” and select the type of user to be created.

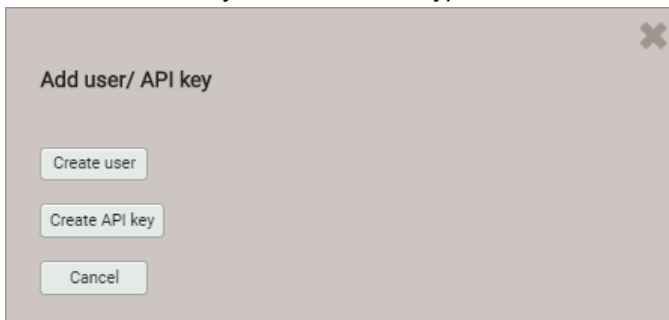

Users: During password definition the requirements for a secure password are checked and the result is displayed. Each new user can be created based on the permission template of an already existing user, but all of these permissions may be changed later.

When defining / changing passwords the following restrictions must be considered:

- Password length 8 up to 32 characters
- At least three different types of characters must be used (uppercase, lowercase, numbers, special characters)

CAUTION: If login credentials (user name and / or password) of users with write access to the security system are changed, this information must be kept safe. For security reasons resetting the RBAC system can only be done at the factory, no backdoor is implemented.

API key: Along with the key name you have to define the permissions to be granted to the application using the key via REST interface. The resulting access rights cannot be changed afterwards.

Once the API key is created it can be displayed using "Show API key"

When the application wants to communicate via REST interface with the device, it has to provide the API key and the session token via the cookie field in the request header, e.g.:

Cookie:

```
AccessToken=eyJhbGciOiJIUzI1NiIsInR5cCI6IkpXVCJ9.eyJhdWQiOiIxYjg4IiwiaWF0IjoxNTc5MTU4OTc0LCJzZW50aW0iOiJhbm9ueWlvdXMiLCJ0eG4iOiIxOTIuMTY4LjU4LjExNCJ9.LiLjuJcs2bZAmYHlvdMXTA1r87gxUX-3kZ4cfz6jdMc;
sessionToken={5d1ca47c-8d38-4a08-85d5-fefdb941fa20}
```

Assignment of user rights

The assignment of the user rights granted for operation is done via the menu Settings | Security system | Users and permissions:

	admin	localgui	anonymous	operator1	operator2	operator3	[API]Access Token
Local account (no weblogin)	<input type="checkbox"/>	<input checked="" type="checkbox"/>	<input type="checkbox"/>	<input type="checkbox"/>	<input type="checkbox"/>	<input type="checkbox"/>	<input type="checkbox"/>
Instantaneous values							
Energy							
Harmonics							
Phasor diagram							
Waveform							
Events							
PQ statistic							
Service							
Reset values							
Reset/Update device							
Audit Log							
Use IO simulation							
Settings							
Basic device settings							
Measurement							
Communication							
Security system							

- Measurements or settings can be displayed
- Measurements or settings cannot be displayed
- Settings can be changed
- Settings cannot be changed
- Field not selectable
- Change a user's login credentials



Overview of the access rights of each possible user

6.8.2 User log in / out via website

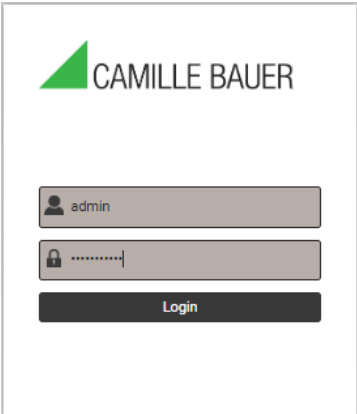

a) If “anonymous” has no granted permissions

Via website	Remarks
	<ol style="list-style-type: none"> 1) Enter user name and password 2) Press <ENTER> or select “Login” <p>If successful, depending on the permissions of the user logged in, the appropriate website is displayed</p>

b) If “anonymous” has granted permissions

Via website	Remarks
	<ol style="list-style-type: none"> 1) Click on the symbol  2) Enter user name and password. On first login use the default settings admin / CBM_1234. 3) Press <ENTER> or select “Login” <p>If successful, depending on the permissions of the user logged in, the appropriate website is displayed</p>

c) If another user is already logged in

Via website	Remarks
	<p>Log out the current user by selecting “Logout”</p> <ol style="list-style-type: none"> 1) Click on the symbol  2) Enter user name and password 3) Press <ENTER> or select “Login” <p>If successful, depending on the permissions of the user logged in, the appropriate website is displayed</p>

6.8.3 User log in / out via local display

a) If “localgui” has no granted permissions

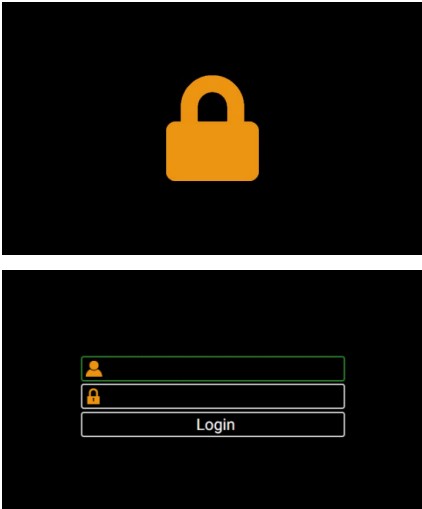
Locally	Remarks
	<p>No information is displayed on the screen. Press <ESC> to enter the login screen.</p> <ol style="list-style-type: none"> 1) Press <OK> to enter the user name 2) Proceed to password using ▼ 3) Press <OK> to enter the password 4) Proceed to Login and press <OK> <p>If successful, depending on the permissions of the user logged in, the appropriate menu is displayed.</p>

b) If localgui has granted permissions

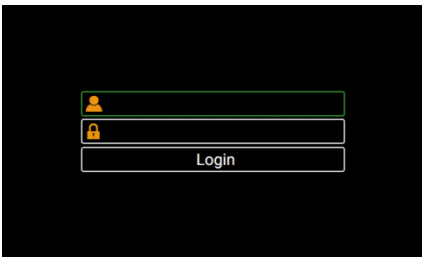
Locally	Remarks
	<p>Repeatedly press <ESC> until the login screen is displayed.</p> <ol style="list-style-type: none"> 1) Press <OK> to enter the user name 2) Proceed to password using ▼ 3) Press <OK> to enter the password 4) Proceed to Login and press <OK> <p>If successful, depending on the permissions of the user logged in, the appropriate menu is displayed</p>

c) If another user is already logged in

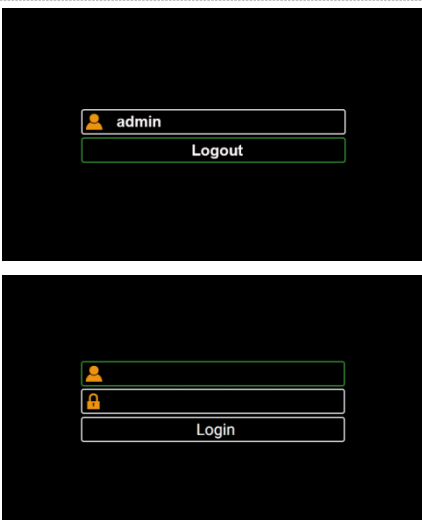
Locally	Remarks
	<p>Repeatedly press <ESC> until the login screen is displayed.</p> <p>Log out the current user by selecting “Logout”</p> <p>Depending on the permissions of localgui either a menu or the lock symbol is displayed</p> <p>Repeatedly press <ESC> until the login screen is displayed.</p> <ol style="list-style-type: none"> 1) Press <OK> to enter the user name 2) Proceed to password using ▼ 3) Press <OK> to enter the password 4) Proceed to Login and press <OK> <p>If successful, depending on the permissions of the user logged in, the appropriate menu is displayed.</p>

6.8.4 Whitelisting clients

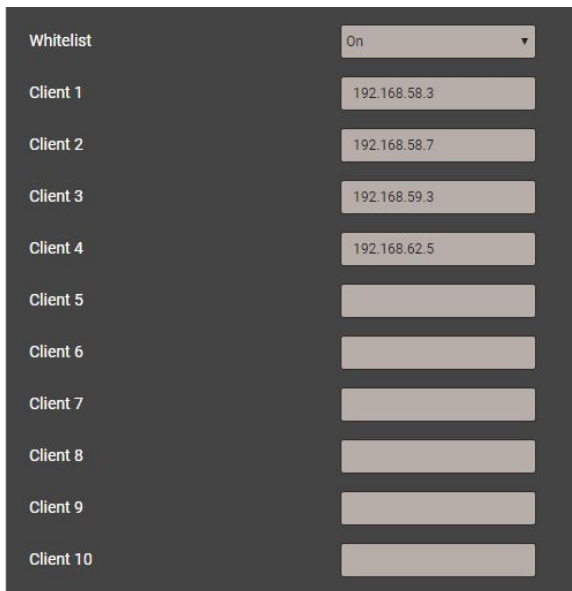

It is possible to define a list of IPv4 and/or IPv6 addresses of up to 10 clients allowed to have access to the device. All other clients will be blocked. Enable the whitelist via the *Settings* of the *Security system* in the item *Whitelist*.



If a DHCP server is used in the system, clients may get different IP addresses on each startup, losing this way access to the device.

If a device is no longer accessible you can reset its IP address (LAN), deactivating the whitelist at the same time. The whitelist may be switched off via WLAN interface as well.

6.8.5 Secure communication using https

According to Enel specifications https communication is activated by default. This protocol provides encrypted communication using TLS (Transport Layer Security). Such as bidirectional encryption of communications between a client and server protects against eavesdropping and tampering of the communication, by creating a secure channel over an insecure network.

Before HTTPS communication can be used a root certificate needs to be installed. The user can either use a Camille Bauer certificate (default setting) or its own customer certificate. This may be changed when defining the Settings of the Security system.

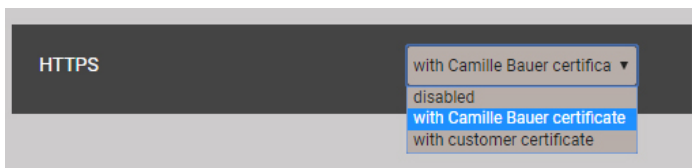

Camille Bauer certificate

Source: For example <https://www.camillebauer.com/dm5000-en>

Once the certificate is downloaded to the local computer the certificate can be installed manually. Just double-click on the file. **Install certificate**, then select **Place all certificates in the following store**, **Browse** and select **Trusted Root Certification Authorities**. **Finish** the Import Wizard.

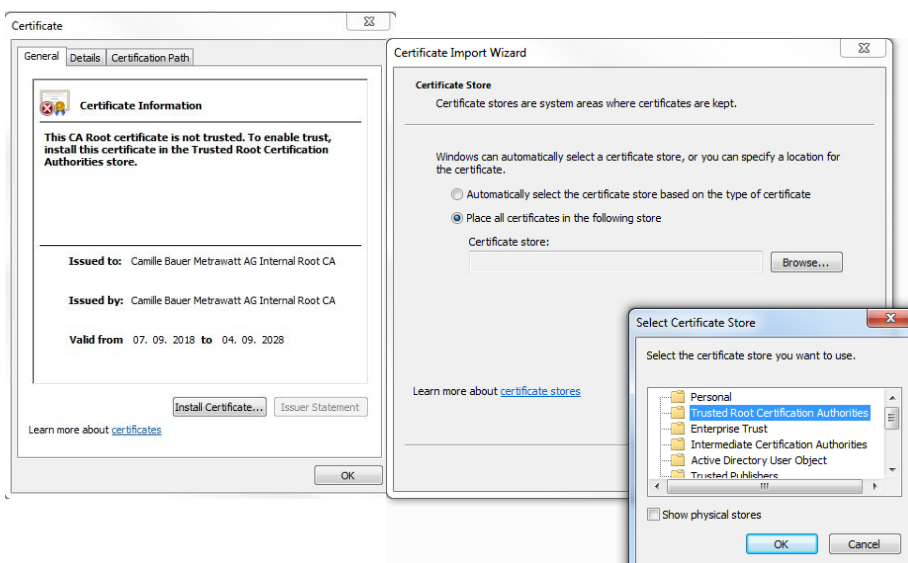

The imported certificate is valid for all devices of the PQ, AM, DM and CU series.

Agree to install the certificate if the below security warning appears:



Customer certificate

You may also use a customer server certificate with a private key, but for that you first need to change the *Settings* of the *Security system* in the item *Web Security*.

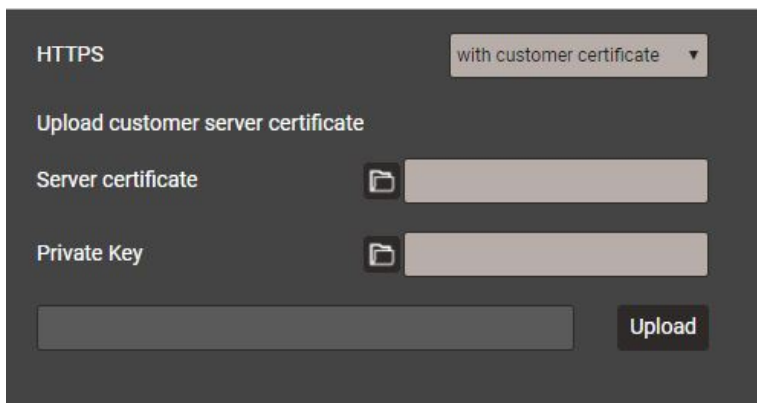

You may use https communication also by ignoring any browser warning and establishing an **unsecure** connection to the device. However, for security reasons you should not work like that in the intended network environment.

6.8.6 Audit log (SYSLOG)

Security related events, such as ...

- a computer establishing a connection to the device
- a user logged in /out
- a failed login attempt
- each changing of the device configuration
- the view of the security log by a user
- etc.

are logged in a security log accessible via the service menu.

Navigation: [K] [←] [1] [2] [3] [4] [→] [+5>>] Results per page: 25 [↻]

Filter: [Emergency] [Alert] [Critical] [Error] [Warning] [Notice] [Info] [Debug]

Time	PID	Priority	IP address	User name	Message
17.01.2020, 09:35:59	cb-gui[2126]	Notice	192.168.57.65:54375	admin	User reviewed latest security event log (allow)
17.01.2020, 09:35:54	cb-gui[2126]	Notice	192.168.57.65:54375	admin	User logged in successfully
17.01.2020, 08:33:30	sshd[2436]	Info	192.168.58.58:11348	root	Accepted password ssh2
17.01.2020, 08:31:18	sshd[2420]	Info	192.168.58.58:11318	root	Accepted password ssh2
17.01.2020, 08:31:17	sshd[2416]	Info	192.168.58.58:11315	root	Accepted password ssh2
17.01.2020, 08:24:56	cb-gui[2126]	Info	192.168.57.65:53539	admin	User logged out successfully
17.01.2020, 08:04:45	cb-gui[2126]	Notice	192.168.57.65:53387	admin	User reviewed latest security event log (allow)
17.01.2020, 08:02:59	cb-pq3000[2120]	Notice			The device was power off on Fri Jan 17 07:57:31 2020
17.01.2020, 08:02:59	cb-pq3000[2120]	Notice			The device was power on Fri Jan 17 07:57:31 2020
17.01.2020, 08:02:59	cb-pq3000[2120]	Notice			Firmware update was on Fri Jan 17 08:01:07 2020

Example of a security log: The severity of each message is shown in a color code, which may also serve as filter criteria.

Each entry into this list may, if activated, also be transferred to a central log-server using the **SYSLOG** protocol for security auditing. This transfer may be performed based on UDP, TCP or TLS. The settings of the Syslog server are available via Settings | Communication | Syslog server:

Syslog protocol: TCP

Host: tenserv.camillebauer.com

Port: 514

 For devices **without data logger** the content of the Audit log gets lost on each restart. But, by transferring the information to a central log server using the Syslog protocol, the entries can still be saved.

7. Operating the device

7.1 Operating elements

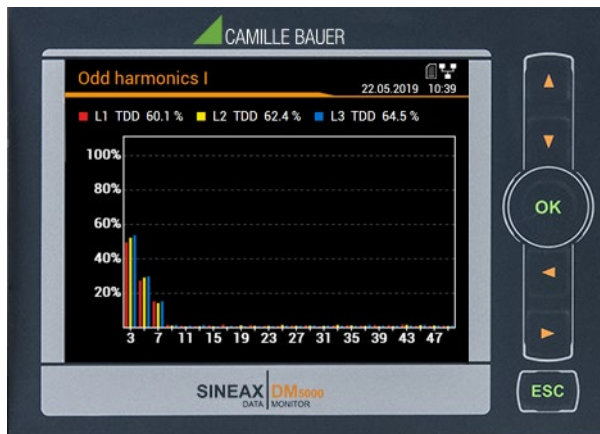

The operation of devices with display is performed by means of 6 keys:

- 4 keys for **navigation** (◀, ▲, ▼, ▶) and for the selection of values
- OK for **selection** or confirmation
- ESC for **menu display**, terminate or cancel

The **function** of the operating keys changes in some measurement displays, during parameterization and in service functions. The valid functionality of the keys is then shown in a help bar.

7.2 Selecting the information to display



For devices with display information selection is performed via menu. Menu items may contain further sub-menus.

Displaying the menu

Press **ESC**. Each time the key is pressed a change to a higher menu level is performed, if present.

Displaying information

The menu item chosen using ▲, ▼ can be selected using **OK**. Repeat the procedure in possible submenus until the required information is displayed.

Return to measurement display

After 2 min. without interaction the menu is automatically closed and the last active measurement display is shown.

7.3 Measurement displays and used symbols

For displaying measurement information the device uses both numerical and numerical-graphical measurement displays.

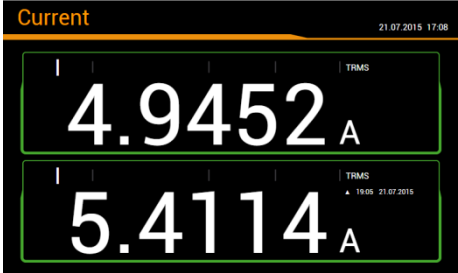
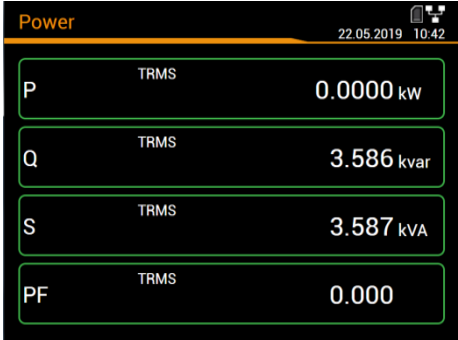
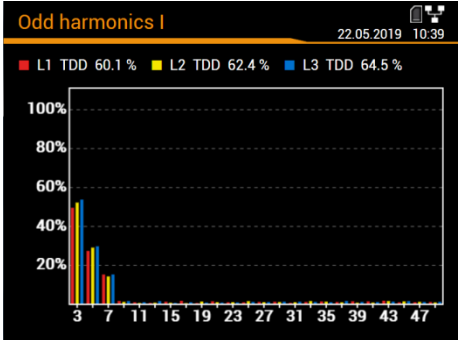
Examples	Measurement information
 <p>The screenshot shows a 'Current' display with two numerical values: 4.9452 A and 5.4114 A. Both values are labeled as TRMS. The top value is dated 21.07.2015 17:08, and the bottom value is dated 19.05.21.07.2019.</p>	2 measured quantities
 <p>The screenshot shows a 'Power' display with four numerical values: P (0.0000 kW), Q (3.586 kvar), S (3.587 kVA), and PF (0.000). All values are labeled as TRMS. The date and time are 22.05.2019 10:42.</p>	4 measured quantities
 <p>The screenshot shows an 'Odd harmonics I' display with a bar chart. The chart shows TDD percentages for L1 (60.1%), L2 (62.4%), and L3 (64.5%) across various harmonic orders (3, 7, 11, 15, 19, 23, 27, 31, 35, 39, 43, 47). The y-axis ranges from 0% to 100%.</p>	Graphical measurement display Further examples

Incoming / outgoing / inductive / capacitive



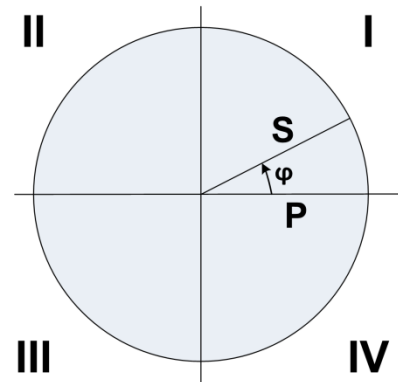



The device provides information for all four quadrants. Quadrants are normally identified using the roman numbers I, II, III and IV, as shown in the adjacent graphic. Depending on whether the system is viewed from the producer or consumer side, the interpretation of the quadrants is changing: The energy built from the active power in the quadrants I+IV can either be seen as delivered or consumed active energy.



By avoiding terms like incoming / outgoing energy and inductive or capacitive load when displaying data, an independent interpretation of the 4-quadrant information becomes possible. Instead the quadrant numbers I, II, III or IV, a combination of them or an appropriate graphical representation is used. You can select your own point of view by selecting the reference arrow system (load or generator) in the settings of the measurement.

Used symbols

For defining a measurement uniquely, a short description (e.g. U_{1N}) and a unit (e.g. V) are often not sufficient. Some measurements need further information, which is given by one of the following symbols or a combination of these symbols:

	Mean-value	ΣHT	Meter (high tariff)
	Mean-value trend	ΣLT	Meter (low tariff)
	Bimetal function (current)	▲	Maximum value
	Energy quadrants I+IV	▼	Minimum value
	Energy quadrants II+III	TRMS	True root-mean-square value
	Energy quadrants I+II	RMS	Root-mean square value (e.g. fundamental or harmonic content only)
	Energy quadrants III+IV	(H1)	Fundamental component only
I,II,III,IV	Quadrants	∅	Average (of RMS values)

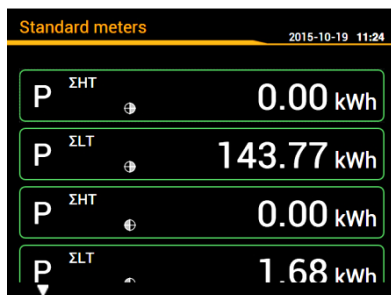

Meters with tariff and quadrant information

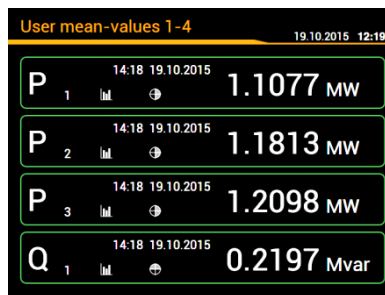

User mean values: Last values

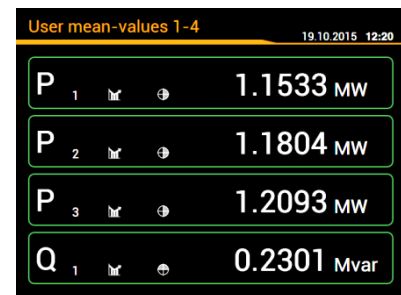

User mean values: Trend

7.4 Resetting measurement data

- **Minimum and maximum values** may be reset during operation. The reset may be performed in groups using the service menu.

Group	Values to be reset
1	Min/max values of voltages, currents and frequency
2	Min/max values of Power quantities (P,Q,Q(H1),D,S); min. load factors
3	Min/max values of power mean-values, bimetal slave pointers and free selectable mean-values
4	Maximum values of harmonic analysis: THD U/I, TDD I, individual harmonics U/I
5	All imbalance maximum values of voltage and current

- **Meter contents** may be individually set or reset during operation using the service menu
- **Recorded logger data** can be individually reset via the service menu. This makes sense whenever the configuration of the quantities to record has been changed.

7.5 Configuration

7.5.1 Configuration at the device

With the exception of the security system a full parameterization of the device can be performed via the menu "Settings".

Modifications will not take effect before the user accepts the query "Store configuration changes" when leaving the settings menu. Changings in the "Country and clock" menu have immediate effect (e.g. a different operating language is used), but nevertheless must be stored.



- **Country and clock:** display language, date format, time zone, clock synchronization, time/date
- **Display:** Refresh rate, brightness, screen saver
- **Communication:** Settings of the communication interfaces [Ethernet](#) and [Modbus/RTU](#). In addition, a [SFTP server](#) may be defined, to push user definable data files to.
- **Measurement:** System type, sense of rotation, nominal values of U / I / f, sampling, reference arrow system etc.

Hints

- *U / I transformer:* The primary to secondary ratio is used only for converting the measured secondary to primary values, so e.g. 100 / 5 is equivalent to 20 / 1. The values do not have any influence on the display format of the measurements.
- *Nominal voltage / current:* Used only as reference values, e.g. for scaling the harmonic content [TDD](#) of the currents
- *Maximum primary values U/I:* These values are used for fixing the display format of the measurements. This way you can optimize the resolution of the displayed values, because there is no dependency to installed transformers.
- *Synchronous sampling:* yes=sampling is adjusted to the measured system frequency to have a constant number of samplings per cycle; no=constant sampling based on the selected system frequency
- *Reference channel:* The measurement of the system frequency is done via the selected voltage or current input
- **Mean-values | standard quantities:** Interval time and synchronization source for the predefined power mean values
- **Mean-values | user defined quantities:** Selection of up to 12 quantities for determining their mean-values and selection of their common interval and synchronization source
- **Bimetal current:** Selection of the response time for determining [bimetal currents](#)
- **Meters | Standard meters:** Tariff switching ON/OFF, [meter resolution](#)
- **Meters | User defined meters:** Base quantities (Px,Qx,Q(H1)x,Sx,Ix), Tariff switching ON/OFF, [meter resolution](#)
- **Meters | Meter logger:** Selection of the reading interval

- **Limit values:** Selection of up to 12 quantities to monitor, [limit values](#) for ON/OFF, event text (only 'a'...'z', 'A'...'Z' and '0'...'9' allowed)
- **Digital inputs:** Debounce time (minimum pulse width), pulse rate and polarity of the [digital inputs](#)
- **Fault current:** Configuration of the fault current channels, especially alarm and prewarning limits, transformer ratios as well as response and dropout delay
- **Temperature:** Configuration of the temperature monitoring channels, especially event text, alarm limits, response and dropout delay, lead resistance
- **Monitoring functions:** Definition of up to 8 [monitoring functions](#) with up to three inputs each, delay times for ON / OFF and event text (only 'a'...'z', 'A'...'Z' and '0'...'9' allowed)
- **Summary alarm:** Selection of the monitoring functions to be used for triggering the [summary alarm](#) and selection of a possible source for resetting
- **Operating hours:** Selection of the running condition for up to 3 operating hour counters
- **Digital outputs | Digital output:** State, pulse or remote controlled [digital output](#) with source, pulse width, polarity, number of pulses per unit
- **Digital outputs | Relay:** State or remote controlled relay output with source
- **Analog outputs:** Type of output, source, transfer characteristic, upper/lower range limit
- **Security system:** Definition of password and password protection active/inactive
- **Demo mode:** Activation of a presentation mode; measurement data will be simulated. Demo mode is automatically stopped when rebooting the device.
- **Device tag:** Definition of different texts, such as device tag, document title, device location and others. Note: Only the characters 'a'...'z', 'A'...'Z' and '0'...'9' may be used.
- **Data export scheduler:** Via [website](#) you can setup tasks to be performed regularly. Each time such a task is running, it creates a data file to be transferred to a SFTP server and/or to be stored locally on the device. Via local configuration tasks can be enabled or disabled only.

7.5.2 Configuration via web browser

	It's recommended to use either Google-Chrome or Firefox as browser.
	Internet Explorer works with limitations only (partly missing texts, firmware update not possible)

For configuring via Webbrowser you have to display the device website using:



- IPv4 communication: `http://IPv4_addr`, e.g. `http://192.168.1.101`
- IPv6 communication: `http://[IPv6_addr]`, e.g. `http://[fd2d:bb44:97f1:3976::1]`

This request works only if device and PC are in the same network segment. Depending on the device version, there may be multiple network interfaces with different [default IP addresses](#).

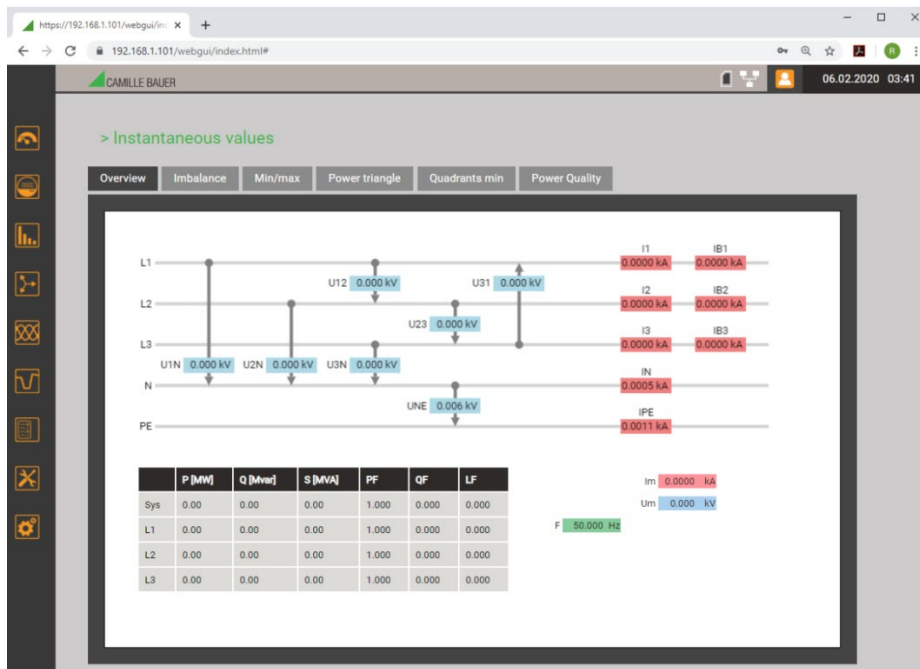
If the [secure communication via https](#) is activated and the root certificate installed, you have to use https instead of http for displaying the website

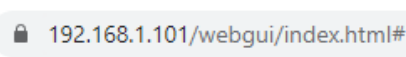

Device website using Google Chrome

	The locker symbol shows that a secure connection is established (if https is used)
	There are three information here: <ul style="list-style-type: none"> • The SD-card is present and stores data • A network connection is established • User and permissions management is active, but no user is logged in so far.



Via WEB-GUI you can make the same settings as via the [local GUI](#) using the Settings menu.

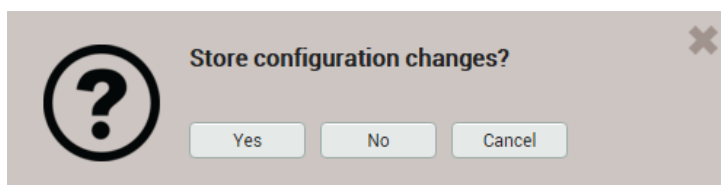

In addition it is possible to setup the [security system](#) and to setup the [Data export scheduler](#). Possibly modifications needs to be saved in the device, before all parameters have been set. In such a case the following message appears:



If this request is not confirmed unsaved modifications of the present device configuration may get lost.

Loading / saving configuration files

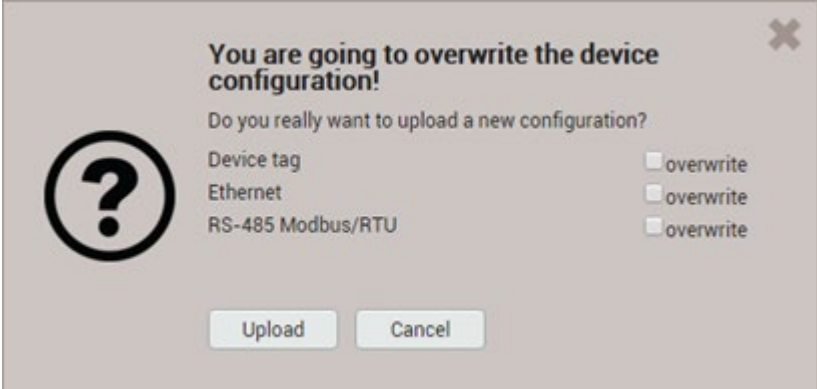
The user can save the present device configuration on a storage media and reload it from there. The storage or load procedure varies depending on the used browser.

	<p>Loading a configuration file from a storage media</p> <p>The configuration data of the selected file will be directly loaded into the device. The values in the WEB-GUI will be updated accordingly. Normally devices differ in the settings of network or Modbus parameters and device name. Thus when loading the file you can choose, whether the appropriate settings of the device should be retained or overwritten by the values in the file to be uploaded.</p> <div data-bbox="454 495 1275 882"></div>
	<p>Storing the current parameter settings of the WEB-GUI into the device</p>
	<p>Saving the device configuration to a storage media</p> <p>Attention: Modifications in the WEB-GUI, which haven't been stored in the device, will not be written to the storage media.</p>

7.6 Alarming

The alarming concept is very flexible. Depending on the user requirements simple or more advanced monitoring tasks may be realized. The most important objects are limit values on base quantities, the monitoring of fault-current, monitoring functions and the summary alarm.

7.6.1 Limit values on base quantities

Limit value 1		2016-06-20 17:52
Monitored quantity	Voltage U1N	
Limit for ON	200	
Limit for OFF	205	
Event text	Low voltage U1N	
List entry	Alarms	

Using limit values either the exceeding of a given value (upper limit) or the fall below a given value (lower limit) is monitored.

Limits values are defined by means of two parameters: Limit for ON / OFF. The hysteresis corresponds to the difference between these two values.

If a data logger is implemented both state transitions OFF→ON and ON→OFF can be recorded as event or alarm in the appropriate lists.

Upper limit: $\text{Limit for ON} \geq \text{Limit for OFF}$

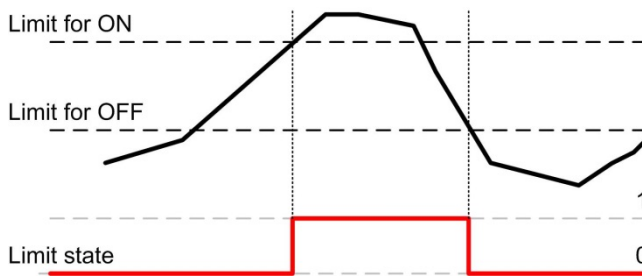

- ▶ The limit value becomes active (1) as soon as the limit for ON state is exceeded. It remains active until the associated measured quantity falls below the limit for OFF state again.
- ▶ The limit value is inactive (0) if either the limit for ON is not yet reached or if, following the activation of the limit value, the associated measured quantity falls below the limit for OFF state again.

Lower limit: $\text{Limit for ON} < \text{Limit for OFF}$

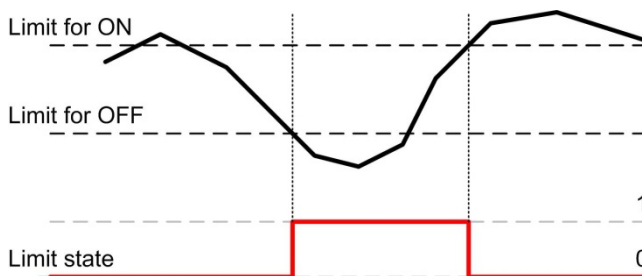

- ▶ The limit value becomes active (1) as soon as the associated measured quantity falls below the limit for ON state. It remains active until the associated measured quantity exceeds the limit for OFF state again.
- ▶ The limit value is inactive (0) if either the associated measured quantity is higher than the limit for ON state or if, following the activation of the limit value, it exceeds the limit for OFF state again.

 If the limit for ON state and the limit for OFF state are configured to the same value, the limit value will be treated as an upper limit value without hysteresis.

Limit value states can:

- ... directly be used as source for a digital output
- ... be used as logic input for a monitoring function
- ... be recorded as event or alarm in the appropriate lists on each changing

7.6.2 Monitoring fault-currents

Each (optional) fault current module provides **two channels** for monitoring residual or fault current. For each of the channels an alarm and a prewarning limit can be defined, which can be used as follows:

- ... Activating a [summary alarm](#) when the alarm limit is violated or a breakage occurs (2mA input only)
- ... as logic input for [monitoring functions](#)
- ... as source for digital outputs
- ... Entry into the alarm list, if the state of the alarm limits monitoring changes or when a breakage occurs (2mA input only)
- ... Entry into the event list, if the state of the prewarning limits monitoring changes
- ... the value of the individual fault currents can also be output via the analog outputs

The present values of the monitored fault currents are visible via the menu of the instantaneous values:

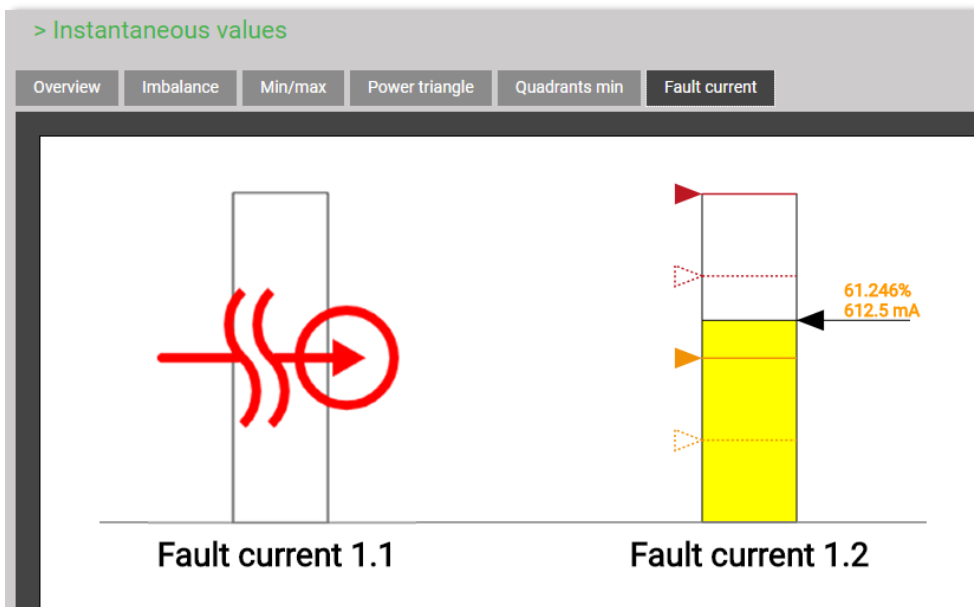

Meaning of the used symbols

	Current value normal
	Prewarning limit violated
	Alarm limit violated
	Alarm: Configured limit for ON
	Alarm: Configured limit for OFF
	Prewarning: Configured limit for ON
	Prewarning: Configured limit for OFF
	Breakage of measurement line detected

7.6.3 Temperature monitoring

Each (optional) temperature module provides **two channels** for temperature monitoring.

Used for Pt100 measurement

- Up to 2 limit values
- Short circuit and wire / sensor breakage monitoring

Used for PTC monitoring

- Monitoring the PTC response temperature
- Short circuit monitoring

Usage of the determined states

- ... Activating a [summary alarm](#) when an alarm limit is violated (Pt100) or the response temperature is reached (PTC), a short-circuit or a wire / sensor breakage (Pt100) occurs
- ... as logic input for [monitoring functions](#)
- ... as source for digital outputs
- ... Entry into the alarm list when any state change occurs
- ... the present temperature for Pt100 measurement can also be output via analog outputs

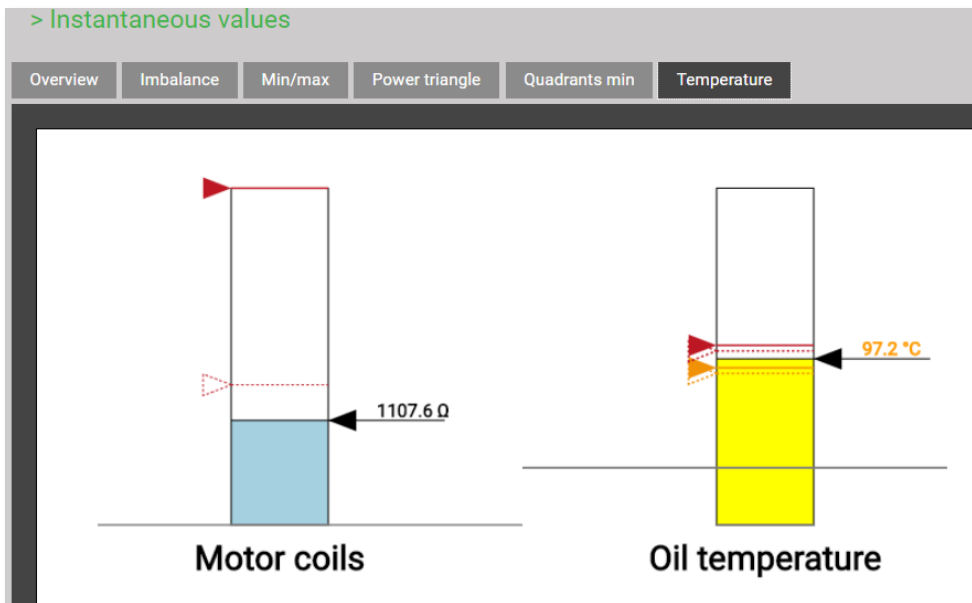

State of temperature monitoring in the instantaneous values menu, PTC on the left, Pt100 on the right

Meaning of the used symbols

	Measurement in the normal range
	Alarm limit 1 violated
	Alarm limit 1 violated
	Alarm 2: Configured limit for ON
	Alarm 2: Configured limit for OFF
	Alarm 1: Configured limit for ON
	Alarm 1: Configured limit for OFF
	Wire / sensor breakage detected
	Short-circuit detected

7.6.4 Monitoring functions

By means of monitoring functions the user can define an extended condition monitoring, e.g. for triggering an over-current alarm, if one of the phase currents exceeds a certain limit value.

The states of all monitoring functions

...will be shown in the alarm list ("Events" via main menu)

...build a summary alarm state

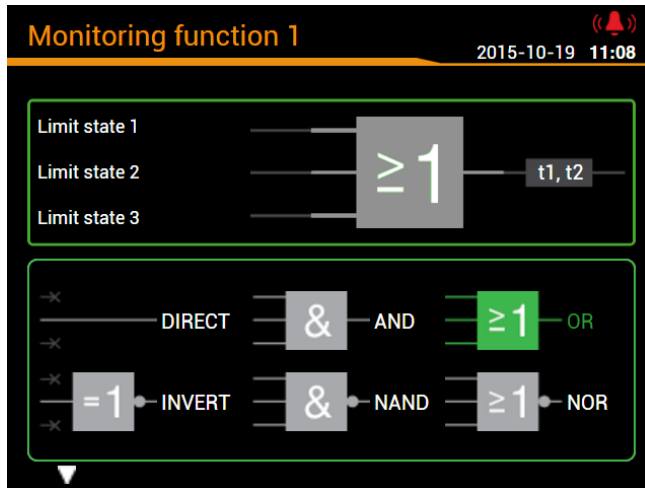

Logic inputs

Up to three states of limit values, fault-current or temperature monitoring, logic inputs or other monitoring functions. Unused inputs will automatically be initialized in a way that they do not influence the output.

Logic function

For the logical combination of the inputs the function AND, NAND, OR, NOR, DIRECT and INVERT are available. These logical functions are described in [Appendix C](#).

Delay time on

The time a condition must be present until it is forwarded

Delay time off

Time to be waited until a condition, which is no longer present, will be released again

Description

This text will be used for visualization in the alarm list

List entry (with data logger only)

- *Alarm / event*: Each state transition will be recorded in the appropriate list
- *none*: No recording of state transitions

Possible follow-up actions

- Driving a logic output. The assignment of the monitoring function to a digital output / relay is done via the settings of the corresponding output.
- Visualization of the present state in the alarm list
- Combining the states of all monitoring functions to create a summary alarm
- Recording of state transitions as alarm or event in the appropriate lists

7.6.5 Summary alarm

The summary alarm combines the states of all [monitoring functions](#) MFx to a superior alarm-state of the overall unit. For each monitoring function you may select if it is used for building the summary alarm state. If at least one of the used functions is in the alarm state, the summary alarm is also in the alarm state.

If an optional failure-current monitoring is present, the detection of an alarm state or a breakage of the measurement line (2mA inputs only) activates directly the summary alarm.

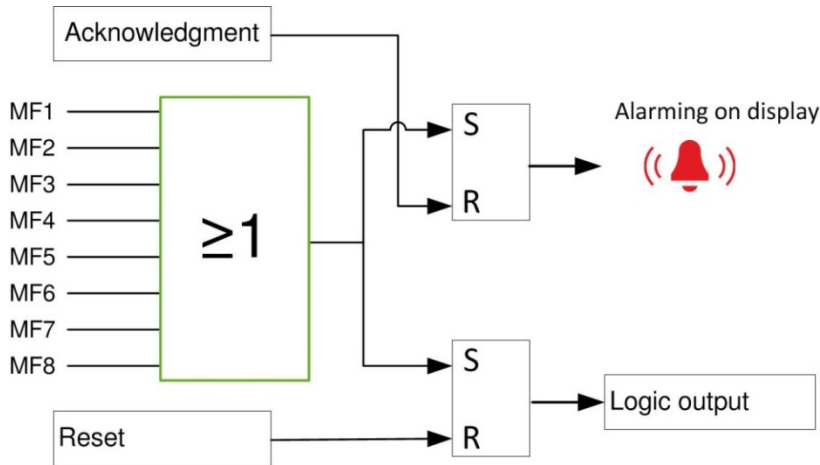

Alarm display

The symbol arranged in the status bar signals if there are active alarms or not.

Acknowledgment: By acknowledging the summary alarm, the user confirms that he has recognized that an alarm state occurred. The acknowledgment is done automatically as soon as the user selects the alarm list to be displayed locally or via web browser or if the alarm state no longer exists. By acknowledging only the flashing of the alarm symbol stops, the symbol itself remains statically displayed until none of the monitoring functions is in the alarm state.

Logic output

The summary alarm can drive an output. The assignment of a digital output / relay to the summary alarm is done via the settings of the corresponding output.

Reset: The state of the summary alarm - and therefore of the used output - can be reset, even if there is still an alarm active. So, for example a horn activated via summary alarm can be deactivated. A reset may be performed via display, via web browser, a digital input or the Modbus interface. The logic output becomes active again as soon as another monitoring function goes to the alarm state or if the same alarm becomes active again.

Alarm state display

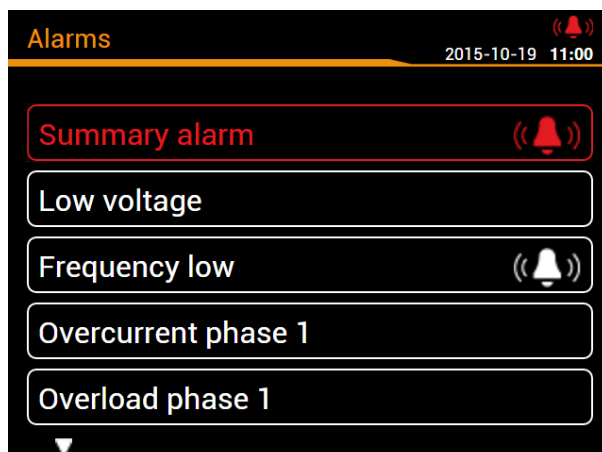





The digital or relay output assigned to the summary alarm can be reset by means of the <OK> key. So the active alarming will be stopped. But the alarm state of the summary alarm remains active until the alarm state no longer exists.

7.7 Data recording

The optional data logger provides long-term recordings of measurement progressions and events.

In addition, file based information can periodically be created using the [data export scheduler](#). Such data can be stored internally and / or securely sent to a SFTP server.

The recording is performed in endless mode (oldest data will be deleted, as soon as the associated memory is used for more than 80%).

Group	Data type	Request	
Periodic data	<ul style="list-style-type: none"> • Mean-values versus time, predefined (5) and user-specific (12) quantities • Periodic meter readings, predefined (4) and user-specific (12) quantities 	 Energy	<ul style="list-style-type: none"> • Mean value logger • Meter logger
Events	<p>In form of a logbook with time information:</p> <ul style="list-style-type: none"> • Event list: Every state transition of monitoring functions or limit values, classified as event and each violation of the pre-warning level of the (optional) fault current channels • Alarm list: Every state transition of monitoring functions or limit values, classified as alarm and each violation of the alarm limits of the (optional) fault current channels • Temperature alarm list: Each violation of the limit values of the (optional) temperature channels 	 Events	<ul style="list-style-type: none"> • Event and alarm list
Security events	<ul style="list-style-type: none"> • Security log (SYSLOG) 	 Service	<ul style="list-style-type: none"> • Log of the security system
Disturbance recorder	<p>Events will be registered in the disturbance recorder list. By selecting the entries:</p> <ul style="list-style-type: none"> • the course of the RMS values of all U/I • the wave shape of all U/I <p>during the disturbance will be recorded</p>	 Events	<ul style="list-style-type: none"> • Disturbance recorder

7.7.1 Periodical data

Configuration of the periodic data recording

Via the settings menu the user can individually configure:

- The averaging interval of the standard mean-values P(I+IV), P(II+III), Q(I+II), Q (III+IV), S
- The averaging interval of up to 12 user-defined mean-values
- The reading interval of standard meters P(I+IV), P(II+III), Q(I+II), Q (III+IV)
- The reading interval of up to 12 user-defined meters

The recording of all mean-values and meters is started automatically on device start. The recording of the mean-values is done when the appropriate averaging interval expires.

Displaying the chronology of the mean values

The chronology of the mean values is available via the menu **Energy** and is divided in two groups:

- Pre-defined power mean values
- User-defined mean values

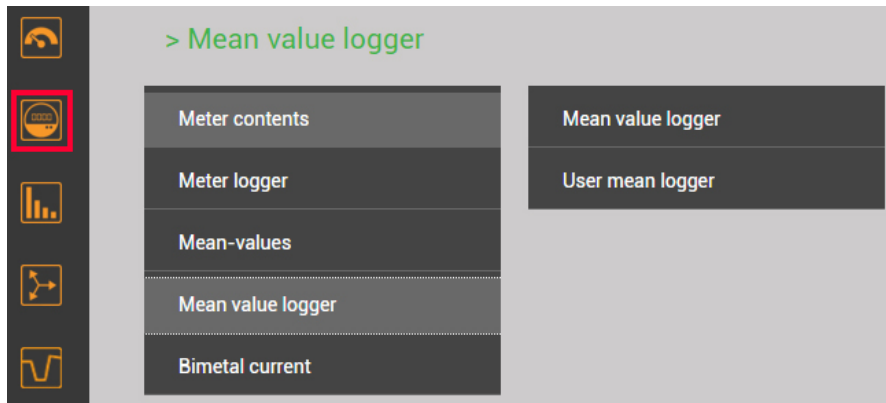

Selection of the mean values group



The selection of the mean-value quantity to display can be performed via choosing the corresponding register. Three different kind of displays are supported:

- Daily profile: Hourly mean-values will be shown, independently of the real averaging time
- Weekly profile
- Table: Listing of all acquired mean-values in the sequence of the real averaging interval

The graphical representation allows comparing directly the values of the previous day or week.

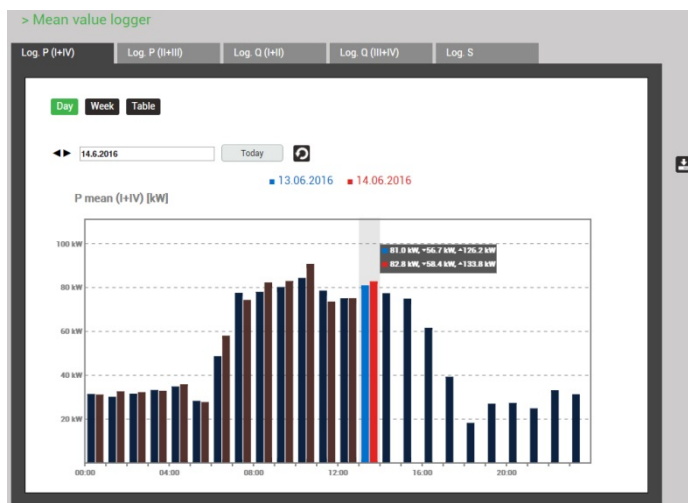

By selecting the bars you may read the associated values:

- Mean-value
- Min. RMS value within the interval
- Max. RMS value within the interval



Weekly display



Weekly display: Reading

#	time	mean	min(interval)	max(interval)
1	14.06.2016, 14.33:00.000	78.89 kW	65.75 kW	109.42 kW
2	14.06.2016, 14.32:00.000	93.65 kW	74.96 kW	125.97 kW
3	14.06.2016, 14.31:00.000	86.42 kW	74.48 kW	104.69 kW
4	14.06.2016, 14.30:00.000	80.17 kW	67.36 kW	106.59 kW
5	14.06.2016, 14.29:00.000	88.62 kW	75.01 kW	111.77 kW
6	14.06.2016, 14.28:00.000	80.96 kW	69.96 kW	116.12 kW
7	14.06.2016, 14.27:00.000	81.96 kW	68.81 kW	108.47 kW
8	14.06.2016, 14.26:00.000	80.98 kW	69.05 kW	102.54 kW
9	14.06.2016, 14.25:00.000	88.52 kW	68.12 kW	123.43 kW

Mean values in table format

Displaying the chronology of meter contents

The chronology of meters is available via the menu **Energy** and is divided in two groups:

- Pre-defined meters
- User-defined meters

From the difference of two successive meter readings the energy consumption for the dedicated time range can be determined.

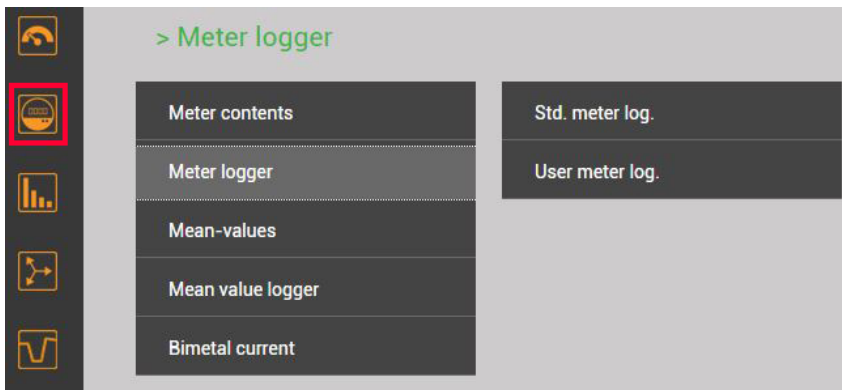

Selection of the meter logger group

> Std. meter log.

Log. ΣP(I+IV) Log. ΣP(II+III) Log. ΣQ(I+II) Log. ΣQ(III+IV)

«Previous 1 2 3 4 5 Next» Results per page 25

#	time	ΣP(I+IV), ΣII	ΣP(II+III), ΣHT
1	15.06.2016, 14:00:00.000	0 kWh	33276.80 kWh
2	15.06.2016, 13:00:00.000	0 kWh	33203.10 kWh
3	15.06.2016, 12:00:00.000	0 kWh	33137.40 kWh
4	15.06.2016, 11:00:00.000	0 kWh	33069.10 kWh
5	15.06.2016, 10:00:00.000	0 kWh	32996 kWh
6	15.06.2016, 09:00:00.000	0 kWh	32919.70 kWh
7	15.06.2016, 08:00:00.000	0 kWh	32849.90 kWh
8	15.06.2016, 07:00:00.000	0 kWh	32784 kWh
9	15.06.2016, 06:00:00.000	0 kWh	32735.30 kWh
10	15.06.2016, 05:00:00.000	0 kWh	32719.10 kWh
11	15.06.2016, 04:00:00.000	0 kWh	32687.10 kWh

Meter content readings in table form

Displaying data locally

The selection works in principle in the same way as with the WEB-GUI. There are the following differences:

- The individual measured quantities are arranged in a display matrix and can be selected via navigation.
- The number of displayable meter readings is limited to 25
- The time range of the mean values is limited to the present day or the present week. There is no possibility for navigation.

Data export as CSV file



Via  the time range of the data to export can be selected. A CSV (Comma separated value) file will be generated. This can be imported as a text file to Excel, with comma as a separator. The same file contains data for all quantities of the respective group.

7.7.2 Events

Configuration of events

For all [monitoring functions](#) and [limit values](#) for which state transitions need to be recorded, the parameter “list entry” must be set to either events or alarms.

Events of the (optional) fault-current and temperature channels are automatically entered into the appropriate lists. The limit values to be monitored can be defined via the items Temperature and Fault current in the settings menu.

Displaying of event entries

Event lists are a kind of logbook. Every state transition of monitored events is recorded in the appropriate list with the time of its occurrence.

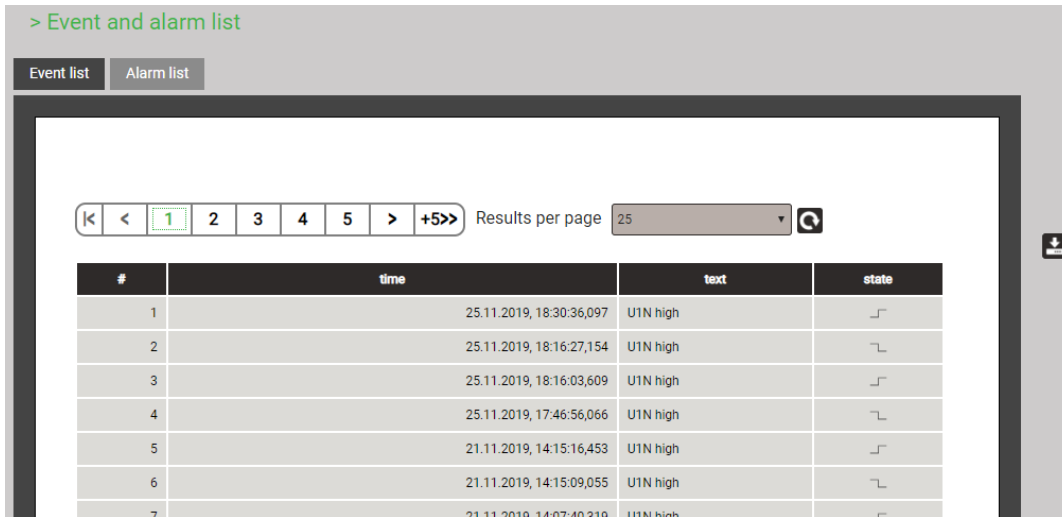
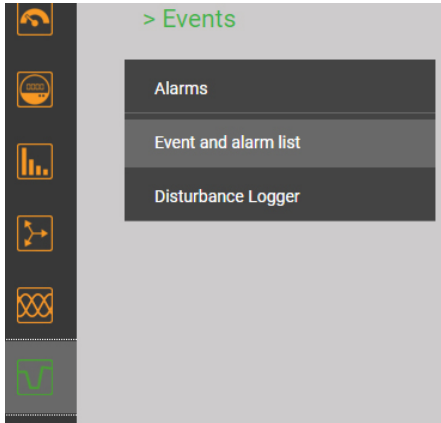

Example of an event list

Displaying data locally

The selection works in principle in the same way as with the WEB-GUI. There is the following difference:

- The number of displayable events is limited to 25

7.7.3 Disturbance recorder

Configuration of the events to record

The device monitors the events voltage dip, swell and interruption. The user can define the threshold levels for these events in the menu **Settings | Disturbance Logger**.

Display of disturbance recordings (locally)

Recorded disturbances are available in the form of a logbook. Each detected disturbance is entered into the disturbance recorder list with the time of its occurrence. By selecting a list entry the graphical display of the measured values during this event is entered. The following presentations are available:

- Half cycle RMS curves of all voltages, all currents, all voltages and currents
- Wave shapes of all voltages, all currents, all voltages and currents

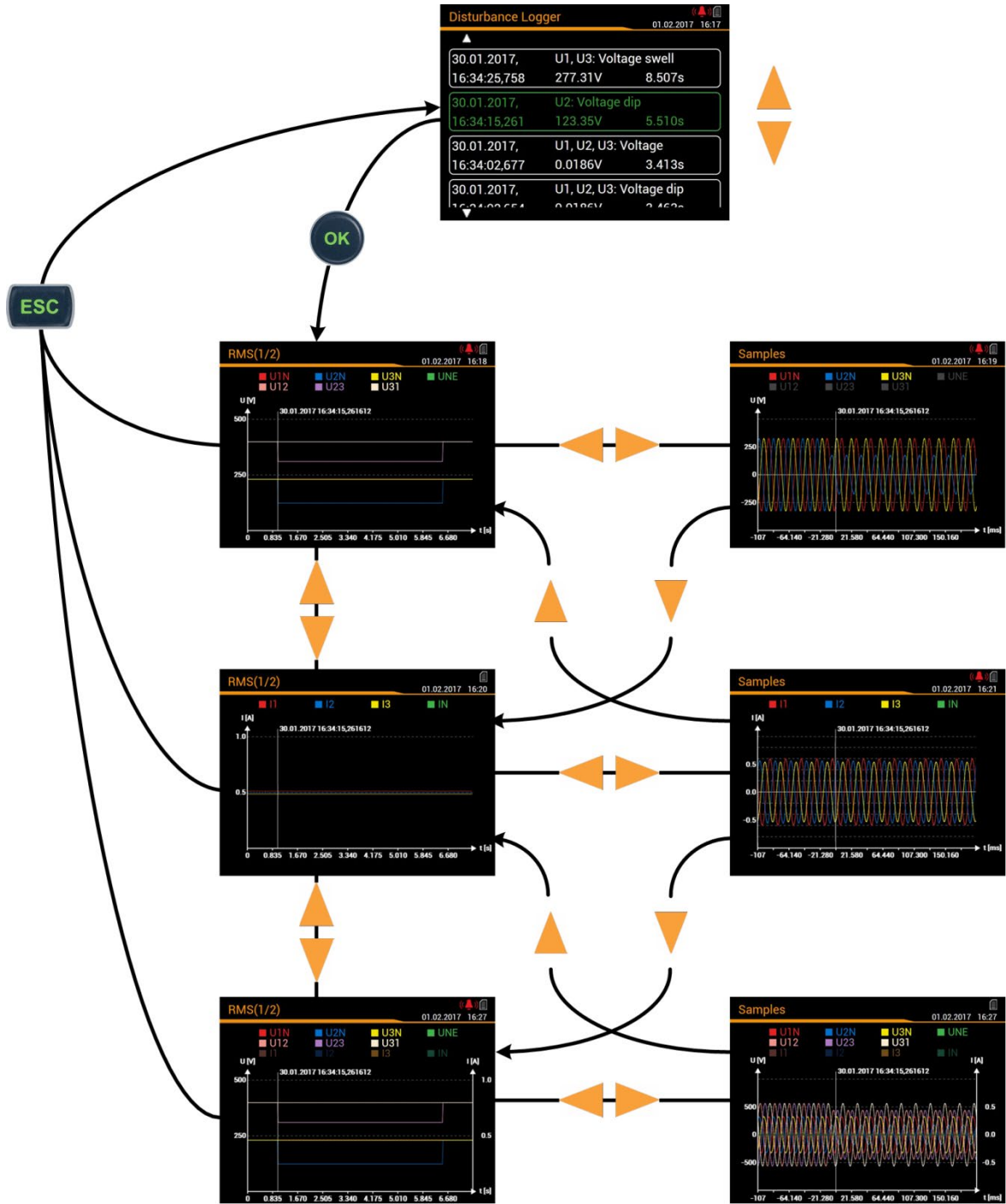

Display matrix on the local display

Restriction of the quantities to display on the local display

The user can adapt the displayed information to its needs. Once the graphic is displayed, the setting window for the selection of the quantities to display is entered by pressing <OK>.

Voltage display

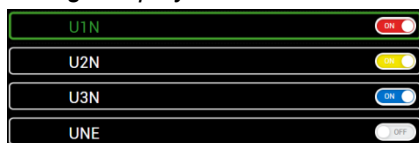

Current display

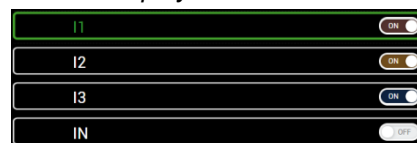

Mixed display



Display of disturbance recordings (WEB-GUI)

As with the local GUI, recorded disturbances are available in the form of a logbook. By selecting a list entry the graphical display of the measured values during this event is entered. By selecting a time range via left mouse key, the graphical event display may be zoomed.

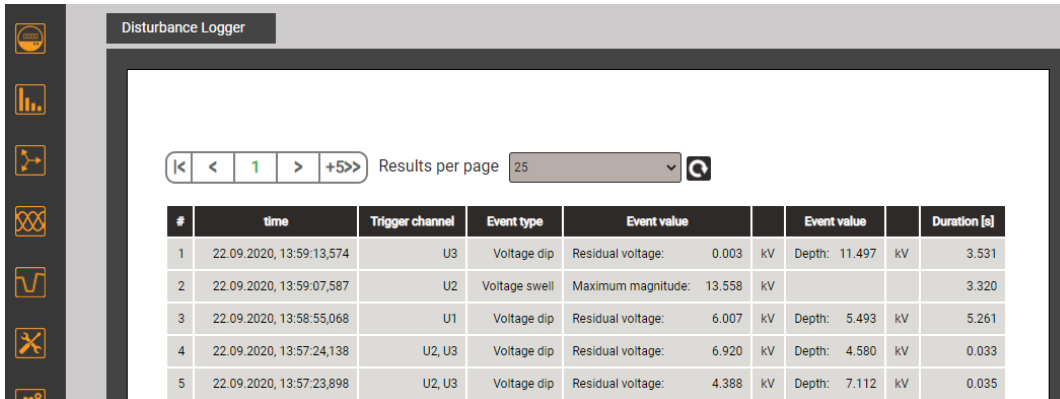

#	time	Trigger channel	Event type	Event value	Event value	Duration [s]
1	22.09.2020, 13:59:13,574	U3	Voltage dip	Residual voltage: 0.003 kV	Depth: 11.497 kV	3.531
2	22.09.2020, 13:59:07,587	U2	Voltage swell	Maximum magnitude: 13.558 kV		3.320
3	22.09.2020, 13:58:55,068	U1	Voltage dip	Residual voltage: 6.007 kV	Depth: 5.493 kV	5.261
4	22.09.2020, 13:57:24,138	U2, U3	Voltage dip	Residual voltage: 6.920 kV	Depth: 4.580 kV	0.033
5	22.09.2020, 13:57:23,898	U2, U3	Voltage dip	Residual voltage: 4.388 kV	Depth: 7.112 kV	0.035

List of disturbance recordings

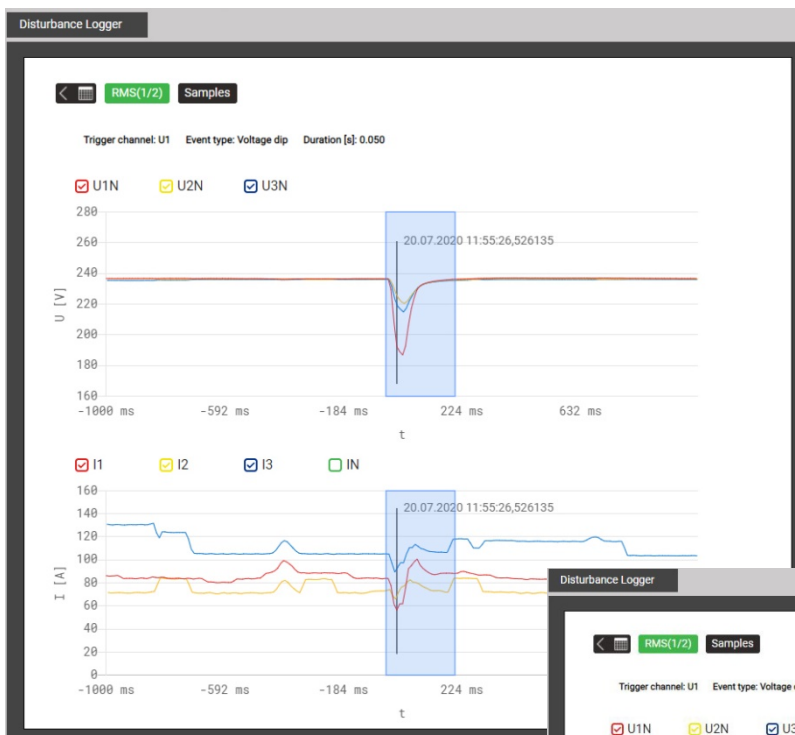

Graphical display of a disturbance recording



Zoomed disturbance recording

7.8 Measurement information in file format

Using the data export scheduler, measurement information may be provided also in file format. Such files can then:

- periodically being sent to an SFTP server
- locally stored in the device and downloaded via webpage

7.8.1 Creating periodic file data

A periodic generation of CSV files can be setup using the Data export scheduler via the menu Settings | Data export. For this tasks may be defined for creating data files with a specific content at regular intervals. These files may be stored locally and / or pushed to a SFTP server.

By selecting “Add task” new schedules can be set-up. An example is shown below:

The new task “24_h_PowerMeans” will generate daily CSV files containing standard mean-values for the past 24 hours.

The files will be both stored locally and pushed to the subfolder PowerMeans of a SFTP server. The [settings](#) of the SFTP server to be used can be defined via Communication | SFTP in the Settings menu.

The transmission window selected here causes a random transmission of the file to the SFTP server within one hour since creation.

At any time the newly created task “24_h_PowerMeans” can be fully modified, deactivated or deleted.

active	Name	Creation	File	Action
<input checked="" type="checkbox"/>	24_h_PowerMeans	daily (last 24 hours)	[CSV] mean values	<ul style="list-style-type: none"> • store on local Storage • push to SFTP server

Via the menu Settings | Data export | Data export scheduler on the local display tasks can only be activated or deactivated.

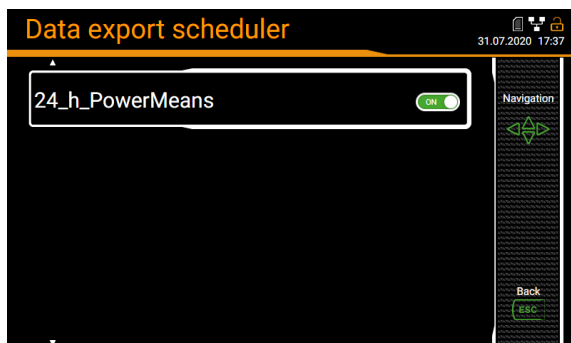

CSV formatting

CSV files are intended to transmit statistics of mean values. You may adjust the below parameters to adapt the file format and the content to your requirements.

Separator	Semicolon
Time format	Local time +AB
include min/max values	Yes
Scaled to...	Nominal values
Digits after decimal point	3

Hint: If the time format “Local time+AB” is used, the letters A and B are added to differentiate duplicate entries between 2 and 3 a.m. when switching back from daylight saving time.

Please note: Measurements will be entered into the CSV file using point as decimal separator. If based on the country settings a different separator (e.g. comma) is used for numbers, this needs to be adapted when importing the file into Excel. This is normally done in step 3/3 of the import, by defining the further text import settings for numerical data:

- “.” as decimal separator
- no separator for thousands

7.8.2 Accessing file information via webpage

You can access files stored in the device using the service menu **Local data storage | Download data**.

Index of /download/data/

Name	Last Modified	Size
 csv/	2020-07-30 22:12	-

7.8.3 Periodical sending to a SFTP Server

If in the data export scheduler the sending to an SFTP server was selected as action, the appropriate files will be sent periodically to the SFTP server defined in the settings of the communication.

Host	tenserv.camillebauer.intra
Port	22
Username	sftpuser
Password	copy
Base directory	data
Only connect to trusted host	No

For improving security you may select that the device connects to trusted hosts only. When activating this setting the host must be present and sends a public key back to the device. If you accept this key the associated host will be added to the list of trusted servers.

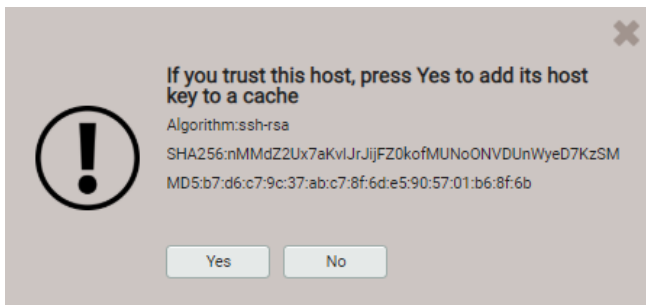

7.9 Timeouts

Devices with display are designed for displaying measurements. So, any other procedure will be terminated after a certain time without user interaction and the last active measurement image will be shown again.

Menu timeout

A menu timeout takes effect after 2 min. without changing the present menu selection. It doesn't matter if the currently displayed menu is the main menu or a sub-menu: The menu is closed and the last active measurement image is displayed again.

Configuration timeout

After 5 min. without interaction in a parameter selection or during entering a value in the settings menu, the active configuration step is closed and the associated parameter remains unchanged. The next step depends on what you have done before:

- If the user did not change configuration parameters before the aborted step, the main menu will be displayed and the device starts to monitor a possible menu timeout.
- If the user changed configuration parameters before the aborted step, the query "Store configuration changes?" is shown. If the user does not answer this query within 2 min. this dialogue is closed: The changed configuration will be stored and activated and then the last active measurement image is displayed again.

8. Service, maintenance and disposal

8.1 Calibration and new adjustment

Each device is adjusted and checked before delivery. The condition as supplied to the customer is measured and stored in electronic form.

The uncertainty of measurement devices may be altered during normal operation if, for example, the specified ambient conditions are not met. If desired, in our factory a calibration can be performed, including a new adjustment if necessary, to assure the accuracy of the device.

8.2 Cleaning

The display and the operating keys should be cleaned in regular intervals. Use a dry or slightly moist cloth for this.



Damage due to detergents

Detergents may not only affect the clearness of the display but also can damage the device. Therefore, do not use detergents.

8.3 Battery

The device contains a battery for buffering the internal clock. It cannot be changed by the user. The replacement can be done at the factory only.

If the UPS option is implemented, the associated battery pack needs to be exchanged regularly. For more information see [chapter 5.14](#).

8.4 Disposal

The product must be disposed in compliance with local regulations. This particularly applies to the built-in battery for the RTC and the battery pack of the UPS option.

9. Technical data

Inputs

Nominal current:	adjustable 1...5 A; max. 7.5 A (sinusoidal)
Measurement category:	300V CAT III
Consumption:	$\leq I^2 \times 0.01 \Omega$ per phase
Overload capacity:	10 A continuous 100 A, 5 x 1 s, interval 300 s
Nominal voltage:	57.7...400 V _{LN} (UL: 347V _{LN}), 100...693 V _{LL} (UL: 600V _{LL});
Measurement max.:	520 V _{LN} , 900 V _{LL} (sinusoidal)
Measurement category:	600V CAT III
Consumption:	$\leq U^2 / 1.54 \text{ M}\Omega$ per phase
Impedance:	1.54 M Ω per phase
Overload capacity:	520 V _{LN} , 900 V _{LL} continuous 800 V _{LN} , 1386 V _{LL} , 10 x 1 s, interval 10s
Systems:	Single phase Split phase (2-phase system) 3-wire, balanced load 3-wire, balanced load, phase shift (2xU, 1xI) 3-wire, unbalanced load 3-wire, unbalanced load, Aron connection 4-wire, balanced load 4-wire, unbalanced load 4-wire, unbalanced load, Open-Y
Nominal frequency:	42...50...58Hz or 50.5...60...69.5Hz, configurable
Sampling rate:	18 kHz

Measurement uncertainty

Reference conditions: Acc. IEC/EN 60688, ambient 15...30°C, sinusoidal input signals (form factor 1.1107), no fixed frequency for sampling, measurement time 200ms (10 cycles at 50Hz, 12 cycles at 60Hz)

Voltage, current:	$\pm 0.1\%$ ^{1) 2)}
Neutral current:	$\pm 0.2\%$ ¹⁾ (if calculated)
Power:	$\pm 0.2\%$ ^{1) 2)}
Power factor:	$\pm 0.2^\circ$
Frequency:	$\pm 0.01 \text{ Hz}$
Imbalance U, I:	$\pm 0.5\%$
Harmonics:	$\pm 0.5\%$
THD U, I:	$\pm 0.5\%$
Active energy:	Class 0.5S, EN 62053-22
Reactive energy:	Class 0.5S, EN 62053-24

Measurement with fixed system frequency:

General	$\pm \text{Basic uncertainty} \times (F_{\text{config}} - F_{\text{actual}}) [\text{Hz}] \times 10$
Imbalance U	$\pm 2\%$ up to $\pm 0.5 \text{ Hz}$
Harmonics	$\pm 2\%$ up to $\pm 0.5 \text{ Hz}$
THD, TDD	$\pm 3.0\%$ up to $\pm 0.5 \text{ Hz}$

¹⁾ Related to the nominal value of the basic quantity

²⁾ Additional uncertainty if neutral wire not connected (3-wire connections)

- Voltage, power: 0.1% of measured value; load factor: 0.1°
- Energy: Voltage influence x 2, angle influence x 2

Zero suppression, range limitations

The measurement of specific quantities is related to a pre-condition which must be fulfilled, that the corresponding value can be determined and sent via interface or displayed. If this condition is not fulfilled, a default value is used for the measurement.

Quantity	Condition	Default
Voltage	$U_x < 1\% U_{x_{nom}}$	0.00
Current	$I_x < 0,1\% I_{x_{nom}}$	0.00
PF	$S_x < 1\% S_{x_{nom}}$	1.00
QF, LF, $\tan\phi$	$S_x < 1\% S_{x_{nom}}$	0.00
Frequency	voltage and/or current input too low ¹⁾	Nominal frequency
Voltage unbalance	$U_x < 5\% U_{x_{nom}}$	0.00
Current unbalance	mean value of phase currents $< 5\% I_{x_{nom}}$	0.00
Phase angle U	at least one voltage $U_x < 5\% U_{x_{nom}}$	120°
Harmonics U, THD-U	fundamental $< 5\% U_{x_{nom}}$	0.00

¹⁾ Specific levels depends on the device configuration

Power supply via terminals 13-14
 Nominal voltage: (see nameplate)
 V1: 100...230V AC 50/60Hz / DC $\pm 15\%$, overvoltage category OVC III
 or
 V2: 24...48V DC $\pm 15\%$
 Consumption: depends on the device hardware used
 $\leq 27 \text{ VA}, \leq 12 \text{ W}$

Available inputs / outputs and functional extensions

Basic unit	<ul style="list-style-type: none"> • 1 digital input • 2 digital outputs
Extensions	Optional modules <ul style="list-style-type: none"> • 2 relay outputs with changeover contacts • 2 bipolar analog outputs • 4 bipolar analog outputs • 4 passive digital inputs • 4 active digital inputs • GPS connection module • 2 failure current channels (residual or earth current) • IEC61850 interface • PROFINET interface • 2 temperature inputs

Up to 2 extensions may be present in the device.

I/O interface

Analog outputs via plug-in terminals
 Linearization: Linear, kinked
 Range: $\pm 20 \text{ mA}$ (24 mA max.), bipolar
 Uncertainty: $\pm 0.2\%$ of 20 mA
 Burden: $\leq 500 \Omega$ (max. 10 V / 20 mA)
 Burden influence: $\leq 0.2\%$
 Residual ripple: $\leq 0.4\%$
 Response time: 220...420 ms

<u>Relays</u>	via plug-in terminals
Contact:	changeover contact
Load capacity:	250 V AC, 2 A, 500 VA 30 V DC, 2 A, 60 W
<u>Passive digital inputs</u>	via plug-in terminals
Nominal voltage	12 / 24 V DC (30 V max.)
Input current	< 7mA
Logical ZERO	- 3 up to + 5 V
Logical ONE	8 up to 30 V
Minimum pulse width	70...250ms
<u>Active digital inputs</u>	via plug-in terminals
Open circuit voltage	≤ 15V
Short circuit current	< 15mA
Current at R _{ON} =800Ω	≥ 2 mA
Minimum pulse width	70...250ms
<u>Digital outputs</u>	via plug-in terminals
Nominal voltage	12 / 24 V DC (30 V max.)
Nominal current	50 mA (60 mA max.)
<u>Fault current detection</u>	via plug-in terminals
Number of channels	2; each channel provides two measurement ranges (2mA, 1A)
Zero suppression	Measurement < 0.2% of measurement range
Measurement range 1A	
Application:	Direct measurement of a fault or earth wire current
Measurement transformer:	Current transformer 1/1 up to 1000/1A Instrument security factor FS5 Rated output 0.2 up to 1.5 VA
Measurement range:	I _{Rated} = 1.0A (max. 1.2A; crest factor 3)
Overload:	2A continuous; 20A, 5 x 1s, interval 300s
Self-consumption:	≤ I ₂ x 0.1 Ω
Monitoring:	Alarm limit 0.03 ... 1000 A (2 up to 100% of primary measurement range)
Measurement range 2mA	
Application:	Residual current monitoring (RCM)
Measurement transformer:	Residual current transformer 500/1 up to 1000/1A Rated burden 100 Ω / 0.025 VA up to 200 Ω / 0.06 VA
Measurement range:	I _{Rated} = 2mA (max. 2.4mA; crest factor 3)
Overload:	40mA continuous; 200mA, 5 x 1s, interval 300s
Self-consumption:	≤ I ₂ x 64 Ω
Monitoring:	Alarm limit 0.03 ... 1 A
Further settings	
Alarm limit for OFF:	I _{OFF} = 90...75% ^{*)}
Prewarning limit:	I _{WARN} = 50%...(I _{OFF} -1%) ^{*)}
Prewarning OFF:	I _{WARN} - (10...25%) ^{*)}
Response delay:	1...10s, separately for alarm and prewarning
Dropout delay:	1...300s, separately for alarm and prewarning

^{*)} All percent values are related to the alarm limit (100%)

Temperature inputs via plug-in terminals
Number of channels: 2
Measurement current: <1.0mA
Connection: 2-wire
Input protection: Voltage limitation via protective diode

Used for Pt100 measurement

Measurement range: -50 up to 250°C / -58 up to 482°F
Uncertainty: ±1.0 % of measurement ±1 K
Connection monitoring: Short-circuit (<20 Ω), wire / sensor breakage (>1000 Ω)
Alarm limits: 2
Response delay: 0...999 s, separately for each alarm limit
Dropout delay: 0...999 s, separately for each alarm limit

Used for PTC monitoring

Alarm active: >3.6 ... 4.0 kΩ
Alarm fall-back: <1.5 ... 1.65 kΩ
Number of sensors: 1...6 single sensors (acc. DIN 44081) in series
1...2 triplet sensors (acc. DIN 44082) in series
Connection monitoring: Short-circuit (<15 Ω ON, >18 Ω OFF)
Application restriction: Ambient temperature of sensor ≥-20°C
Response delay: 0...999 s
Dropout delay: 0...999 s

Interfaces

Ethernet via RJ45 socket
Protocol: Modbus/TCP, NTP, http, https
Physics: Ethernet 100BaseTX
Mode: 10/100 Mbit/s, full/half duplex, auto-negotiation

IEC61850 via RJ45 sockets, 2 equivalent ports
Protocol: IEC61850, NTP
Physics: Ethernet 100BaseTX
Mode: 10/100 Mbit/s, full/half duplex, auto-negotiation

PROFINET via RJ45 sockets, 2 equivalent ports
Conformance class: CC-B
Netload class: III
Protocol: PROFINET, LLDP, SNMP
Physics: Ethernet 100BaseTX
Mode: 10/100 Mbit/s, full/half duplex, auto-negotiation

Note: The interface may only be connected to a local Profinet network, which is designed as SELV circuit according to IEC 60950-1.

Modbus/RTU via plug-in terminal (A, B, C/X)
Protocol: Modbus/RTU
Physics: RS-485, max. 1200m (4000 ft)
Baud rate: 9'600, 19'200, 38'400, 57'600, 115'200 Baud
Number of participants: ≤ 32

Internal clock (RTC)

Uncertainty: ± 2 minutes / month (15 up to 30°C)
Synchronization: none, via Ethernet ([NTP protocol](#)) or [GPS](#)
Running reserve: > 10 years

Uninterruptible power supply (UPS)

Type:	VARTA Easy Pack EZPackL, UL listed MH16707
Nominal voltage:	3.7V
Capacity:	1150 mAh min., 4.5 Wh
Operating duration:	5 times 3 minutes
Life time:	3 up to 5 years, depending on operating and ambient conditions

Ambient conditions, general information

Operating temperature:	<ul style="list-style-type: none">• Device without UPS: -10 up to <u>15 up to 30</u> up to + 55°C• Device with UPS: 0 up to <u>15 up to 30</u> up to + 35°C
Storage temperature:	Base device: -25 up to + 70°C; Battery pack UPS: -20...60°C (<1 month); -20° ...45°C (< 3 months); -20...30°C (< 1 year)
Temperature influence:	0.5 x measurement uncertainty per 10 K
Long term drift:	0.5 x measurement uncertainty per year
Others:	Usage group II (EN 60 688)
Relative humidity:	< 95% no condensation
Altitude:	≤ 2000 m max.
Device to be used indoor only!	

Mechanical attributes

Housing material:	Polycarbonate
Flammability class:	V-0 acc. UL94, non-dripping, free of halogen
Weight:	600 g

Dimensions



Vibration withstand (test according to DIN EN 60 068-2-6)

Acceleration:	<ul style="list-style-type: none">• Device with display: ± 0.25 g (operating); 1.20 g (storage)• Device without display: ± 2 g
Frequency range:	10 ... 150 ... 10 Hz, rate of frequency sweep: 1 octave/minute
Number of cycles:	10 in each of the 3 axes

Safety

The current inputs are galvanically isolated from each other

Protection class: II (protective insulation, voltage inputs via protective impedance)

Pollution degree: 2

Protection: Front: IP40; Housing: IP30; Terminals: IP20

Rated voltage Power supply V1: 100...230V AC / DC

(versus earth): Power supply V2: 24...48V DC

Relay: 250 V AC (OVC III)

I/O's: 24 V DC

Test voltages: Test time 60s, acc. IEC/EN 61010-1 (2011)

- power supply versus inputs U ¹⁾: 3600V AC
- power supply versus inputs I: 3000V AC
- power supply V1 versus bus, I/O's: 3000V AC
- inputs U versus inputs I: 1800V AC
- inputs U versus bus, I/O's ¹⁾: 3600V AC
- inputs I versus bus, I/O's: 3000V AC
- inputs I versus inputs I: 1500V AC

¹⁾ During type test only, with all protective impedances removed



The device uses the principle of protective impedance for the voltage inputs to ensure protection against electric shock. All circuits of the device are tested during final inspection.

Prior to performing high voltage or isolation tests involving the voltage inputs, all output connections of the device, especially analog outputs, digital and relay outputs as well as Modbus and Ethernet interface, must be removed. A possible high-voltage test between input and output circuits must be limited to 500V DC, otherwise electronic components can be damaged.

Applied regulations, standards and directives

IEC/EN 61010-1	Safety regulations for electrical measuring, control and laboratory equipment
IEC/EN 61000-4-30 Ed.3	Power quality measurement methods
IEC/EN 61000-4-7	General guide on harmonics and interharmonics measurements
IEC/EN 60688	Electrical measuring transducers for converting AC electrical variables into analog or digital signals
DIN 40110	AC quantities
IEC/EN 60068-2-1/ -2/-3/-6/-27:	Ambient tests -1 Cold, -2 Dry heat, -3 Damp heat, -6 Vibration, -27 Shock
IEC/EN 60529	Protection type by case
IEC/EN 61000-6-4	Electromagnetic compatibility (EMC): Emission standard for industrial environments
IEC/EN 61000-6-5	Electromagnetic compatibility (EMC): Immunity for equipment used in power station and substation environment
IEC/EN 61131-2	Programmable controllers - equipment, requirements and tests (digital inputs/outputs 12/24V DC)
IEC/EN 61326	Electrical equipment for measurement, control and laboratory use - EMC requirements
IEC/EN 62053-22	Static meters for AC active energy (classes 0,1S, 0,2S and 0,5S)
IEC/EN 62053-24	Static meters for reactive energy at fundamental frequency (classes 0,5S, 1S, 1, 2 and 3)
IEC/EN 62053-31	Pulse output devices for electromechanical and electronic meters (S0 output)
IEC/EN 60529	Protection type by case
UL94	Tests for flammability of plastic materials for parts in devices and appliances
2011/65/EU (RoHS)	EU directive on the restriction of the use of certain hazardous substances

Warning

This is a class A product. In a domestic environment this product may cause radio interference in which case the user may be required to take adequate measures.

This device complies with part 15 of the FCC:

Operation is subject to the following two conditions: (1) This device may not cause harmful interference, and (2) this device must accept any interference received, including interference that may cause undesired operation.

This Class A digital apparatus complies with Canadian ICES-0003.

Annex

A Description of measured quantities

Used abbreviations

1L	Single phase system
2L	Split phase; system with 2 phases and center tap
3Lb	3-wire system with balanced load
3Lb.P	3-wire system with balanced load, phase shift (only 2 voltages connected)
3Lu	3-wire system with unbalanced load
3Lu.A	3-wire system with unbalanced load, Aron connection (only 2 currents connected)
4Lb	4-wire system with balanced load
4Lu	4-wire system with unbalanced load
4Lu.O	4-wire system with unbalanced load, Open-Y (reduced voltage connection)

A1 Basic measurements

The basic measured quantities are calculated each 200ms by determining an average over 10 cycles at 50Hz or 12 cycles at 60Hz. If a measurement is available depends on the selected system.

Depending on the measured quantity also minimum and maximum values are determined and non-volatile stored with timestamp. These values may be reset by the user via display, see [resetting of measurements](#).

Measurement	present	max	min	1L	2L	3Lb	3Lb.P	3Lu	3Lu.A	4Lb	4Lu.O	4Lu
Voltage U	•	•	•	√	√		√			√		
Voltage U_{1N}	•	•	•		√						√	√
Voltage U_{2N}	•	•	•		√						√	√
Voltage U_{3N}	•	•	•								√	√
Voltage U_{12}	•	•	•			√		√	√		√	√
Voltage U_{23}	•	•	•			√		√	√		√	√
Voltage U_{31}	•	•	•			√		√	√		√	√
Voltage $U_{NE}^{3)4)}$	•	•		√	√	√		√	√	√	√	√
Current I	•	•		√		√	√			√		
Current I1	•	•			√			√	√		√	√
Current I2	•	•			√			√	√		√	√
Current I3	•	•						√	√		√	√
Neutral current I_N	•	•		√	√					√	√	√
Earth current I_{PE} (calculated) ³⁾	•	•									√	√
Active power P	•	•		√	√	√	√	√	√	√	√	√
Active power P1	•	•			√						√	√
Active power P2	•	•			√						√	√
Active power P3	•	•									√	√
Fundamental active power P(H1)	•	•		√	√	√	√	√	√	√	√	√
Fundamental active power P1(H1)	•	•			√						√	√
Fundamental active power P2(H1)	•	•			√						√	√
Fundamental active power P3(H1)	•	•									√	√
Total reactive power Q	•	•		√	√	√	√	√	√	√	√	√
Total reactive power Q1	•	•			√						√	√
Total reactive power Q2	•	•			√						√	√
Total reactive power Q3	•	•									√	√
Distortion reactive power D	•	•		√	√	√	√	√	√	√	√	√
Distortion reactive power D1	•	•			√						√	√
Distortion reactive power D2	•	•			√						√	√
Distortion reactive power D3	•	•									√	√
Fundamental reactive power Q(H1)	•	•		√	√	√	√	√	√	√	√	√
Fundamental reactive power Q1(H1)	•	•			√						√	√
Fundamental reactive power Q2(H1)	•	•			√						√	√
Fundamental reactive power Q3(H1)	•	•									√	√

Measurement	present	max	min	1L	2L	3Lb	3Lb.P	3Lu	3Lu.A	4Lb	4Lu.O	4Lu
Apparent power S	•	•		√	√	√	√	√	√	√	√	√
Apparent power S1	•	•			√						√	√
Apparent power S2	•	•			√						√	√
Apparent power S3	•	•									√	√
Fundamental apparent power S(H1)	•	•		√	√	√	√	√	√	√	√	√
Fundamental apparent power S1(H1)	•	•			√						√	√
Fundamental apparent power S2(H1)	•	•			√						√	√
Fundamental apparent power S3(H1)	•	•									√	√
Frequency F	•	•	•	√	√	√	√	√	√	√	√	√
Power factor PF	•			√	√	√	√	√	√	√	√	√
Power factor PF1	•				√						√	√
Power factor PF2	•				√						√	√
Power factor PF3	•										√	√
PF quadrant I			•	√	√	√	√	√	√	√	√	√
PF quadrant II			•	√	√	√	√	√	√	√	√	√
PF quadrant III			•	√	√	√	√	√	√	√	√	√
PF quadrant IV			•	√	√	√	√	√	√	√	√	√
Reactive power factor QF	•			√	√	√	√	√	√	√	√	√
Reactive power factor QF1	•				√						√	√
Reactive power factor QF2	•				√						√	√
Reactive power factor QF3	•										√	√
Load factor LF	•			√	√	√	√	√	√	√	√	√
Load factor LF1	•				√						√	√
Load factor LF2	•				√						√	√
Load factor LF3	•										√	√
cosφ (H1)	•			√	√	√	√	√	√	√	√	√
cosφ L1 (H1)	•				√						√	√
cosφ L2 (H1)	•				√						√	√
cosφ L3 (H1)	•										√	√
cosφ (H1) quadrant I			•	√	√	√	√	√	√	√	√	√
cosφ (H1) quadrant II			•	√	√	√	√	√	√	√	√	√
cosφ (H1) quadrant III			•	√	√	√	√	√	√	√	√	√
cosφ (H1) quadrant IV			•	√	√	√	√	√	√	√	√	√
tanφ (H1)	•			√	√	√	√	√	√	√	√	√
tanφ L1 (H1)	•				√						√	√
tanφ L2 (H1)	•				√						√	√
tanφ L3 (H1)	•										√	√
$U_{mean}=(U1N+U2N)/2$	•				√							
$U_{mean}=(U1N+U2N+U3N)/3$	•											√
$U_{mean}=(U12+U23+U31)/3$	•					√		√	√			
$I_{mean}=(I1+I2)/2$	•				√							
$I_{mean}=(I1+I2+I3)/3$	•							√			√	√
IMS, Average current with sign of P	•			√	√	√	√	√	√	√	√	√
Phase angle between U1 and U2	•					√		√	√		√	√
Phase angle between U2 and U3	•					√		√	√		√	√
Phase angle between U3 and U1	•					√		√	√		√	√
Angle between U and I	•			√		√	√	√	√	√		
Angle between U1 and I1	•				√						√	√
Angle between U2 and I2	•				√						√	√
Angle between U3 and I3	•										√	√
Maximum ΔU <> Um ¹⁾	•	•			√	√		√	√			√
Maximum ΔI <> Im ²⁾	•	•			√			√			√	√

¹⁾ maximum deviation from the mean value of all voltages (see A3)

²⁾ maximum deviation from the mean value of all currents (see A3)

³⁾ AM3000 only

⁴⁾ For 3-wire systems: Homopolar voltage, only if its measurement has been activated

• Available via communication interface only

Reactive power

Most of the loads consume a combination of ohmic and inductive current from the power system. Reactive power arises by means of the inductive load. But the number of non-linear loads, such as RPM regulated drives, rectifiers, thyristor controlled systems or fluorescent lamps, is increasing. They cause non-sinusoidal AC currents, which may be represented as a sum of harmonics. Thus the reactive power to transmit increases and leads to higher transmission losses and higher energy costs. This part of the reactive power is called distortion reactive power.

Normally reactive power is unwanted, because there is no usable active component in it. Because the transmission of reactive power over long distances is uneconomic, it makes sense to install compensation systems close to the consumers. So transmission capacities may be used better and losses and voltage drops by means of harmonic currents can be avoided.

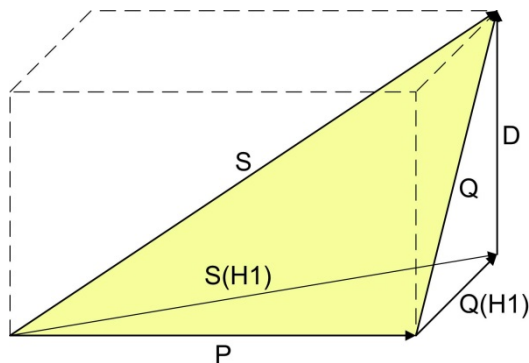

- P: Active power
- S: Apparent power including harmonic components
- S1: Fundamental apparent power
- Q: Total reactive power
- Q(H1): Fundamental reactive power
- D: Distortion reactive power

The reactive power may be divided in a fundamental and a distortion component. Only the fundamental reactive power may be compensated directly by means of the classical capacitive method. The distortion components have to be combated using inductors or active harmonic conditioners.

The **load factor PF** is the relation between active power P and apparent power S, including all possibly existing harmonic parts. This factor is often called $\cos\varphi$, which is only partly correct. The PF corresponds to the **cos φ** only, if there is no harmonic content present in the system. So the **cos φ** represents the relation between the active power P and the fundamental apparent power S(H1).

The **tan φ** is often used as a target quantity for the capacitive reactive power compensation. It corresponds to the relation of the fundamental reactive power Q(H1) and the active power P.

Power factors

The **power factor PF** gives the relation between active and apparent power. If there are no harmonics present in the system, it corresponds to the $\cos\varphi$ or displacement power factor. The PF has a range of -1...0...+1, where the sign gives the direction of energy flow.

The **load factor LF** is a quantity derived from the PF, which allows making a statement about the load type. Only this way it's possible to measure a range like 0.5 capacitive ... 1 ... 0.5 inductive in a non-ambiguous way.

The **reactive power factor QF** gives the relation between reactive and apparent power.

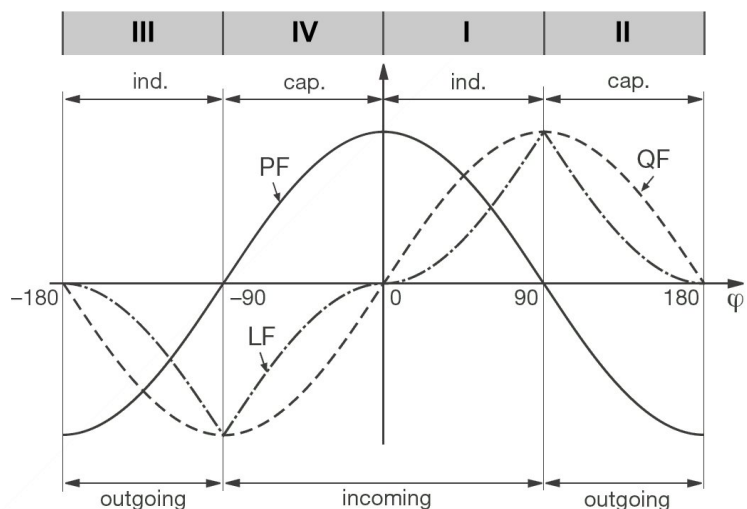

Example from the perspective of an energy consumer

Zero displacement voltage U_{NE}

Starting from the generating system with star point E (which is normally earthed), the star point (N) on load side is shifted in case of unbalanced load. The zero displacement voltage between E and N may be determined by a vectorial addition of the voltage vectors of the three phases:

$$U_{NE} = - (U_{1N} + U_{2N} + U_{3N}) / 3$$

A displacement voltage may also occur due to harmonics of order 3, 9, 15, 21 etc., because the dedicated currents add in the neutral wire.

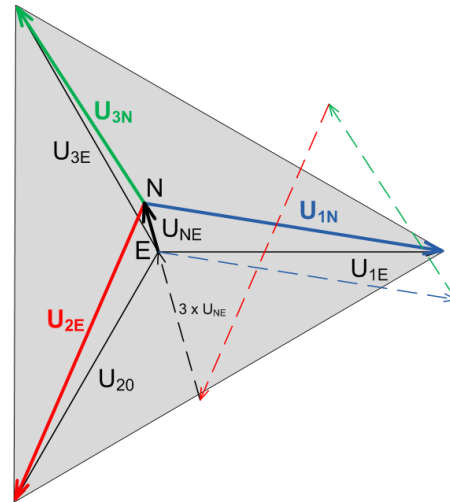

Earth fault monitoring in IT systems

Via the determination of the zero displacement voltage it's possible to detect a first earth fault in an unearthed IT system. To do so, the device is configured for measurement in a 4-wire system with unbalanced load and the neutral connector is connected to earth. In case of a single phase earth fault there is a resulting zero displacement voltage of $U_{LL} / \sqrt{3}$. The alarming may be done e.g. by means of a relay output.

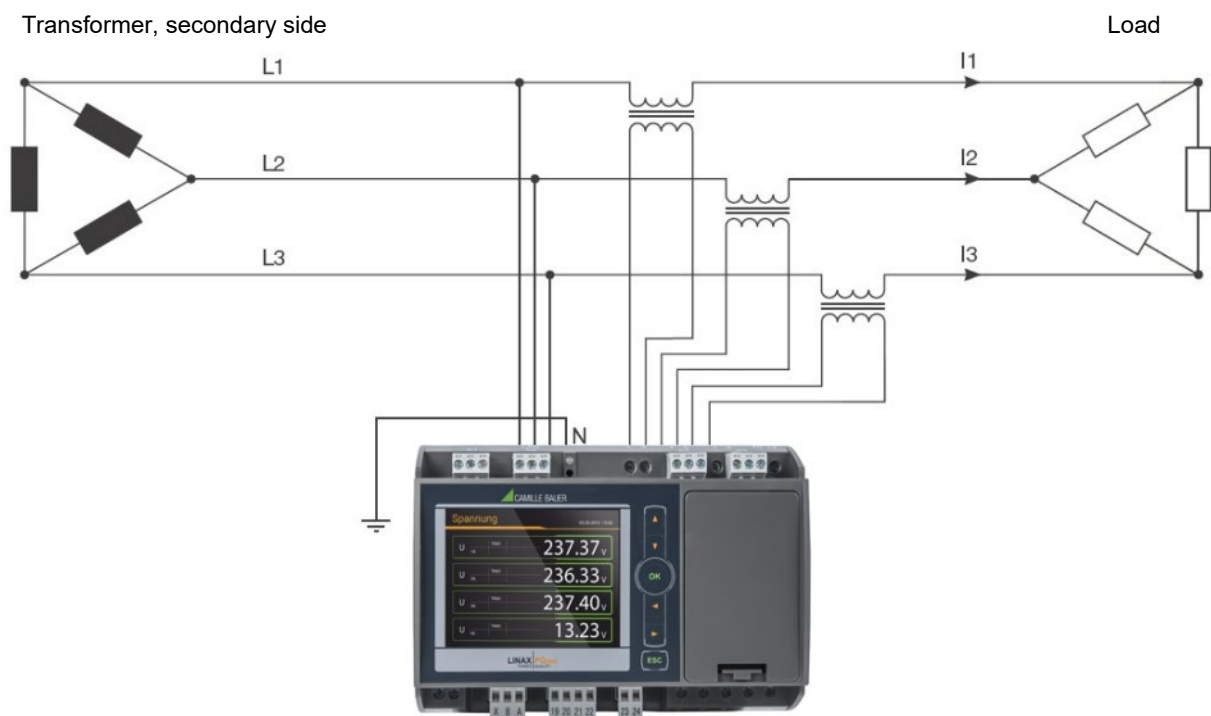

Because in case of a fault the voltage triangle formed by the three phases does not change, the voltage and current measurements as well as the system power values will still be measured and displayed correctly. Also the meters carry on to work as expected.

The method is suited to detect a fault condition during normal operation. A declination of the isolation resistance may not be detected this way. This should be measured during a periodical control of the system using a mobile system.

Another possibility to analyze fault conditions in a grid offers the method of the [symmetrical components](#) as described in A3.

A2 Harmonic analysis

The harmonic analysis is performed according IEC 61000-4-7 over 10 cycles at 50Hz or 12 cycles at 60Hz. If a measured quantity is available depends on the selected system.

Measurement	present	max	1L	2L	3Lb	3Lb.P	3Lu	3Lu.A	4Lb	4Lu.O	4Lu
THD Voltage U1N/U	•	•	√	√		√			√	√	√
THD Voltage U2N	•	•		√						√	√
THD Voltage U3N	•	•								√	√
THD Voltage U12	•	•			√		√	√			
THD Voltage U23	•	•			√		√	√			
THD Voltage U31	•	•			√		√	√			
THD Current I1/I	•	•	√	√	√	√	√	√	√	√	√
THD Current I2	•	•		√			√	√		√	√
THD Current I3	•	•					√	√		√	√
TDD Current I1/I	•	•	√	√	√	√	√	√	√	√	√
TDD Current I2	•	•		√			√	√		√	√
TDD Current I3	•	•					√	√		√	√
Harmonic contents 2 nd ...50 th U1N/U	•	•	√	√		√			√	√	√
Harmonic contents 2 nd ...50 th U2N	•	•		√						√	√
Harmonic contents 2 nd ...50 th U3N	•	•								√	√
Harmonic contents 2 nd ...50 th U12	•	•			√		√	√			
Harmonic contents 2 nd ...50 th U23	•	•			√		√	√			
Harmonic contents 2 nd ...50 th U31	•	•			√		√	√			
Harmonic contents 2 nd ...50 th I1/I	•	•	√	√	√	√	√	√	√	√	√
Harmonic contents 2 nd ...50 th I2	•	•		√			√	√		√	√
Harmonic contents 2 nd ...50 th I3	•	•					√	√		√	√

Harmonic contents are available up to the 89th (50Hz) or 75th (60Hz) on the Modbus interface

• Available via communication interface only

Harmonics

Harmonics are multiples of the fundamental or system frequency. They arise if non-linear loads, such as RPM regulated drives, rectifiers, thyristor controlled systems or fluorescent lamps are present in the power system. Thus undesired side effects occur, such as additional thermal stress to operational resources or electrical mains, which lead to an advanced aging or even damage. Also the reliability of sensitive loads can be affected and unexplainable disturbances may occur. In industrial networks the image of the harmonics gives good information about the kind of loads connected. See also:

► [Increase of reactive power due to harmonic currents](#)

TDD (Total Demand Distortion)

The complete harmonic content of the currents is calculated additionally as Total Demand Distortion, briefly TDD. This value is scaled to the rated current or rated power. Only this way it's possible to estimate the influence of the current harmonics on the connected equipment correctly.

Maximum values

The maximum values of the harmonic analysis arise from the monitoring of THD and TDD. The maximum values of individual harmonics are not monitored separately, but are stored if a maximum value of THD or TDD is detected. The image of the maximum harmonics therefore always corresponds to the dedicated THD or TDD.



The accuracy of the harmonic analysis strongly depends on the quality of the current and voltage transformers possibly used. In the harmonics range transformers normally change both, the amplitude and the phase of the signals to measure. It's valid: The higher the frequency of the harmonic, the higher its damping or phase shift.

A3 System imbalance

Measured quantity	present	max	1L	2L	3Lb	3Lb.P	3Lu	3Lu.A	4Lb	4Lu.O	4Lu
UR1: Positive sequence [V]	•				√		√	√			√
UR2: Negative sequence [V]	•				√		√	√			√
U0: Zero sequence [V]	•										√
U: Imbalance UR2/UR1	•	•			√		√	√			√
U: Imbalance U0/UR1	•	•									√
IR1: Positive sequence [A]	•						√			√	√
IR2: Negative sequence [A]	•						√			√	√
I0: Zero sequence [A]	•									√	√
I: Imbalance IR2/IR1	•	•					√			√	√
I: Imbalance I0/IR1	•	•								√	√

• Available via communication interface only

Imbalance in three-phase systems may occur due to single-phase loads, but also due to failures, such as e.g. the blowing of a fuse, an earth fault, a phase failure or an isolation defect. Also harmonics of the 3rd, 9th, 15th, 21st etc. order, which add in the neutral wire, may lead to imbalance. Operating resources dimensioned to rated values, such as three-phase generators, transformers or motors on load side, may be excessively stressed by imbalance. So a shorter life cycle, a damage or failure due to thermal stress can result. Therefore monitoring imbalance helps to reduce the costs for maintenance and extends the undisturbed operating time of the used resources.

Imbalance or unbalanced load relays use different measurement principles. One of them is the approach of the symmetrical components, the other one calculates the maximum deviation from the mean-value of the three phase values. The results of these methods are not equal and don't have the same intention. Both of these principles are implemented in the device.

Symmetrical components (acc. Fortescue)

The imbalance calculation method by means of the symmetrical components is ambitious and intensive to calculate. The results may be used for disturbance analysis and for protection purposes in three-phase systems. The real existing system is divided in symmetrical system parts: A positive sequence, a negative sequence and (for systems with neutral conductor) a zero sequence system. The approach is easiest to understand for rotating machines. The positive sequence represents a positive rotating field, the negative sequence a negative (braking) rotating field with opposite sense of direction. Therefore the negative sequence prevents that the machine can generate the full turning moment. For e.g. generators the maximum permissible current imbalance is typically limited to a value of 8...12%.

Maximum deviation from the mean value

The calculation of the maximum deviation from the mean value of the phase currents or phase voltages gives the information if a grid or substation is imbalanced loaded. The results are independent of rated values and the present load situation. So a more symmetrical system can be aspired, e.g. by changing loads from one phase to another.

Also failure detection is possible. The capacitors used in compensation systems are wear parts, which fail quite often and then have to be replaced. When using three phase power capacitors all phases will be compensated equally which leads to almost identical currents flowing through the capacitors, if the system load is comparable. By monitoring the current imbalance it's then possible to estimate if a capacitor failure is present.

The maximum deviations are calculated in the same steps as the instantaneous values and therefore are arranged there ([see A1](#)).

A4 Mean values and trend

Measured quantity		Present	Trend	max	min	History
Active power I+IV	10s...60min. ¹⁾	•	•	•	•	5
Active power II+III	10s...60min. ¹⁾	•	•	•	•	5
Reactive power I+II	10s...60min. ¹⁾	•	•	•	•	5
Reactive power III+IV	10s...60min. ¹⁾	•	•	•	•	5
Apparent power	10s...60min. ¹⁾	•	•	•	•	5
Mean value quantity 1	10s...60min. ²⁾	•	•	•	•	1
.....						
Mean value quantity 12	10s...60min. ²⁾	•	•	•	•	1

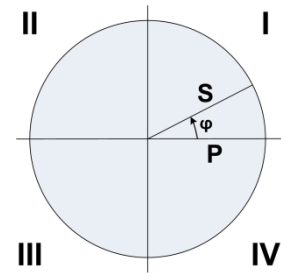

¹⁾ Interval time t1 ²⁾ Interval time t2

The device calculates automatically the mean values of all system power quantities. In addition up to 12 further mean value quantities can be freely selected.

Calculating the mean-values

The mean value calculation is performed via integration of the measured instantaneous values over a configurable averaging interval. The interval time may be selected in the range from 10 seconds up to one hour. Possible interim values are set the way that a multiple of it is equal to a minute or an hour. Mean values of power quantities (interval time t1) and free quantities (interval time t2) may have different averaging intervals.

Synchronization

For the synchronization of the averaging intervals the internal clock or an external signal via digital input may be used. In case of an external synchronization the interval should be within the given range of one second up to one hour. The synchronization is important for making e.g. the mean value of power quantities on generating and demand side comparable.

Trend

The estimated final value (trend) of mean values is determined by weighted addition of measurements of the past and the present interval. It serves for early detection of a possible exceeding of a given maximum value. This can then be avoided, e.g. by switching off an active load.

History

For mean values of system powers the last 5 interval values may be displayed on the device or read via interface. For configurable quantities the value of the last interval is provided via communication interface.

Bimetal current

This measured quantity serves for measuring the long-term effect of the current, e.g. for monitoring the warming of a current-carrying line. To do so, an exponential function is used, similar to the charging curve of a capacitor. The response time of the bimetal function can be freely selected, but normally it corresponds to the interval for determining the power mean-values.

Measured quantity		Present	max	1L	2L	3Lb	3Lb.P	3Lu	3Lu.A	4Lb	4Lu.O	4Lu
Bimetal current IB,	1...60min. ³⁾	•	•	√		√	√			√		
Bimetal current IB1,	1...60min. ³⁾	•	•		√			√	√		√	√
Bimetal current IB2,	1...60min. ³⁾	•	•		√			√	√		√	√
Bimetal current IB3,	1...60min. ³⁾	•	•					√	√		√	√

³⁾ Interval time t3

A5 Meters

Measured quantity		1L	2L	3Lb	3Lb.P	3Lu	3Lu.A	4Lb	4Lu.O	4Lu
Active energy I+IV, high tariff		•	•	•	•	•	•	•	•	•
Active energy II+III, high tariff		•	•	•	•	•	•	•	•	•
Reactive energy I+II, high tariff		•	•	•	•	•	•	•	•	•
Reactive energy III+IV, high tariff		•	•	•	•	•	•	•	•	•
Active energy I+IV, low tariff		•	•	•	•	•	•	•	•	•
Active energy II+III, low tariff		•	•	•	•	•	•	•	•	•
Reactive energy I+II, low tariff		•	•	•	•	•	•	•	•	•
Reactive energy III+IV, low tariff		•	•	•	•	•	•	•	•	•
User configured meter 1	Only basic quantities can be selected which are supported in the present system.									
User configured meter 2										
User configured meter 3										
User configured meter 4										
User configured meter 5										
User configured meter 6										
User configured meter 7										
User configured meter 8										
User configured meter 9										
User configured meter 10										
User configured meter 11										
User configured meter 12										

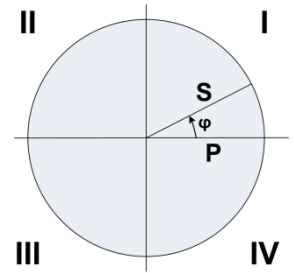

Standard meters

The meters for active and reactive energy of the system are always active.

User configured meters

To each of these meters the user can freely assign a basic quantity.

Programmable meter resolution



For all meters the resolution (displayed unit) can be selected almost freely. This way, applications with short measurement times, e.g. energy consumption of a working day or shift, can be realized. The smaller the basic unit is selected, the faster the meter overflow is reached.

B Display matrices

B0 Used abbreviations for the measurements

Instantaneous values















Name	Measurement identification	Unit	Description
U	U TRMS	V	Voltage system
U1N	U 1N TRMS	V	Voltage between phase L1 and neutral
U2N	U 2N TRMS	V	Voltage between phase L2 and neutral
U3N	U 3N TRMS	V	Voltage between phase L3 and neutral
U12	U 12 TRMS	V	Voltage between phases L1 and L2
U23	U 23 TRMS	V	Voltage between phases L2 and L3
U31	U 31 TRMS	V	Voltage between phases L3 and L1
UNE	U NE TRMS	V	Zero displacement voltage 4-wire systems
I	I TRMS	A	Current system
I1	I 1 TRMS	A	Current phase L1
I2	I 2 TRMS	A	Current phase L2
I3	I 3 TRMS	A	Current phase L3
IN	I N TRMS	A	Neutral current
IPE	I PE TRMS		Earth current
P	P TRMS	W	Active power system (P=P1+P2+P3)
P1	P 1 TRMS	W	Active power phase L1
P2	P 2 TRMS	W	Active power phase L2
P3	P 3 TRMS	W	Active power phase L3
Q	Q TRMS	var	Reactive power system (Q=Q1+Q2+Q3)
Q1	Q 1 TRMS	var	Reactive power phase L1
Q2	Q 2 TRMS	var	Reactive power phase L2
Q3	Q 3 TRMS	var	Reactive power phase L3
S	S TRMS	VA	Apparent power system
S1	S 1 TRMS	VA	Apparent power phase L1
S2	S 2 TRMS	VA	Apparent power phase L2
S3	S 3 TRMS	VA	Apparent power phase L3
F	F TRMS	Hz	System frequency
PF	PF TRMS		Active power factor P/S
PF1	PF 1 TRMS		Active power factor P1/S1
PF2	PF 2 TRMS		Active power factor P2/S2
PF3	PF 3 TRMS		Active power factor P3/S3
QF	QF TRMS		Reactive power factor Q / S
QF1	QF 1 TRMS		Reactive power factor Q1 / S1
QF2	QF 2 TRMS		Reactive power factor Q2 / S2
QF3	QF 3 TRMS		Reactive power factor Q3 / S3
LF	LF TRMS		Load factor system
LF1	LF 1 TRMS		Load factor phase L1
LF2	LF 2 TRMS		Load factor phase L2
LF3	LF 3 TRMS		Load factor phase L3
UR1	U pos SEQ	V	Positive sequence voltage
UR2	U neg SEQ	V	Negative sequence voltage
U0	U zero SEQ	V	Zero sequence voltage
IR1	I pos SEQ	A	Positive sequence current
IR2	I neg SEQ	A	Negative sequence current
I0	I zero SEQ	A	Zero sequence current
UR2R1	U neg/pos UNB	%	Unbalance factor voltage UR2/UR1
IR2R1	I neg/pos UNB	%	Unbalance factor current IR2/IR1
U0R1	U zero/pos UNB	%	Unbalance factor voltage U0/UR1
I0R1	I zero/pos UNB	%	Unbalance factor current I0/IR1
IMS	I  TRMS	A	Average current with sign of P

Minimum and maximum of instantaneous values



















Name	Measurement identification			Unit	Description
U_MM	U		TRMS ▲TS ▼TS	V	Minimum and maximum value of U
U1N_MM	U	1N	TRMS ▲TS ▼TS	V	Minimum and maximum value of U1N
U2N_MM	U	2N	TRMS ▲TS ▼TS	V	Minimum and maximum value of U2N
U3N_MM	U	3N	TRMS ▲TS ▼TS	V	Minimum and maximum value of U3N
U12_MM	U	12	TRMS ▲TS ▼TS	V	Minimum and maximum value of U12
U23_MM	U	23	TRMS ▲TS ▼TS	V	Minimum and maximum value of U23
U31_MM	U	31	TRMS ▲TS ▼TS	V	Minimum and maximum value of U31
UNE_MAX	U	NE	TRMS ▲TS ▼TS	V	Maximum value of UNE
I_MAX	I		TRMS ▲TS	A	Maximum value of I
I1_MAX	I	1	TRMS ▲TS	A	Maximum value of I1
I2_MAX	I	2	TRMS ▲TS	A	Maximum value of I2
I3_MAX	I	3	TRMS ▲TS	A	Maximum value of I3
IN_MAX	I	N	TRMS ▲TS	A	Maximum value of IN
IPE_MAX	I	PE	TRMS ▲TS	A	Maximum value of IPE
P_MAX	P		TRMS ▲TS	W	Maximum value of P
P1_MAX	P	1	TRMS ▲TS	W	Maximum value of P1
P2_MAX	P	2	TRMS ▲TS	W	Maximum value of P2
P3_MAX	P	3	TRMS ▲TS	W	Maximum value of P3
Q_MAX	Q		TRMS ▲TS	var	Maximum value of Q
Q1_MAX	Q	1	TRMS ▲TS	var	Maximum value of Q1
Q2_MAX	Q	2	TRMS ▲TS	var	Maximum value of Q2
Q3_MAX	Q	3	TRMS ▲TS	var	Maximum value of Q3
S_MAX	S		TRMS ▲TS	VA	Maximum value of S
S1_MAX	S	1	TRMS ▲TS	VA	Maximum value of S1
S2_MAX	S	2	TRMS ▲TS	VA	Maximum value of S2
S3_MAX	S	3	TRMS ▲TS	VA	Maximum value of S3
F_MM	F		TRMS ▲TS	Hz	Minimum and maximum value of F
UR21_MAX	U	neg/pos	UNB ▲TS	%	Maximum value of UR2/UR1
IR21_MAX	I	neg/pos	UNB ▲TS	%	Maximum value of IR2/IR1
THD_U_MAX	U		THD ▲TS	%	Max. Total Harmonic Distortion of U
THD_U1N_MAX	U	1N	THD ▲TS	%	Max. Total Harmonic Distortion of U1N
THD_U2N_MAX	U	2N	THD ▲TS	%	Max. Total Harmonic Distortion of U2N
THD_U3N_MAX	U	3N	THD ▲TS	%	Max. Total Harmonic Distortion of U3N
THD_U12_MAX	U	12	THD ▲TS	%	Max. Total Harmonic Distortion of U12
THD_U23_MAX	U	23	THD ▲TS	%	Max. Total Harmonic Distortion of U23
THD_U31_MAX	U	31	THD ▲TS	%	Max. Total Harmonic Distortion of U31
TDD_I_MAX	I		TDD ▲TS	%	Max. Total Demand Distortion of I
TDD_I1_MAX	I	1	TDD ▲TS	%	Max. Total Demand Distortion of I1
TDD_I2_MAX	I	2	TDD ▲TS	%	Max. Total Demand Distortion of I2
TDD_I3_MAX	I	3	TDD ▲TS	%	Max. Total Demand Distortion of I3

TS: Timestamp of occurrence, e.g. 2014/09/17 11:12:03









Mean-values, trend and bimetal current

Name	Measurement identification	Unit	Description
M1	(m) (p) (q)  (t2)	(mu)	Mean-value 1
M2	(m) (p) (q)  (t2)	(mu)	Mean-value 2
....	(m) (p) (q)  (t2)	(mu)
M11	(m) (p) (q)  (t2)	(mu)	Mean-value 11
M12	(m) (p) (q)  (t2)	(mu)	Mean-value 12
TR_M1	(m) (p) (q)  (t2)	(mu)	Trend mean-value 1
TR_M2	(m) (p) (q)  (t2)	(mu)	Trend mean-value 2
....	(m) (p) (q)  (t2)	(mu)
TR_M11	(m) (p) (q)  (t2)	(mu)	Trend mean-value 11
TR_M12	(m) (p) (q)  (t2)	(mu)	Trend mean-value 12
IB	IB  (t3)	A	Bimetal current, system
IB1	IB 1  (t3)	A	Bimetal current, phase L1
IB2	IB 2  (t3)	A	Bimetal current, phase L2
IB3	IB 3  (t3)	A	Bimetal current, phase L3

Minimum and maximum of mean-values and bimetal-current

Name	Measurement identification	Unit	Description
M1_MM	(m) (p) (q)  (t2) 	..	Min/Max mean-value 1
M2_MM	(m) (p) (q)  (t2) 	..	Min/Max mean-value 2
....	(m) (p) (q)  (t2) 
M11_MM	(m) (p) (q)  (t2) 	..	Min/Max mean-value 11
M12_MM	(m) (p) (q)  (t2) 	..	Min/Max mean-value 12
IB_MAX	IB  (t3) 	A	Maximum bimetal current, system
IB1_MAX	IB 1  (t3) 	A	Maximum Bimetal current, phase L1
IB2_MAX	IB 2  (t3) 	A	Maximum Bimetal current, phase L2
IB3_MAX	IB 3  (t3) 	A	Maximum Bimetal current, phase L3

Meters

Name	Measurement identification	Unit	Description
ΣP_{I+IV_HT}	P  ΣHT	Wh	Meter P I+IV, high tariff
ΣP_{II+III_HT}	P  ΣHT	Wh	Meter P II+III, high tariff
ΣQ_{I+II_HT}	Q  ΣHT	varh	Meter Q I+II, high tariff
ΣQ_{III+IV_HT}	Q  ΣHT	varh	Meter Q III+IV, high tariff
ΣP_{I+IV_LT}	P  ΣLT	Wh	Meter P I+IV, low tariff
ΣP_{II+III_LT}	P  ΣLT	Wh	Meter P II+III, low tariff
ΣQ_{I+II_LT}	Q  ΣLT	varh	Meter Q I+II, low tariff
ΣQ_{III+IV_LT}	Q  ΣLT	varh	Meter Q III+IV, low tariff
$\Sigma METER1$	(m) (p) (qg) $\Sigma(T)$	(mu)	User meter 1, tariff HT or LT
$\Sigma METER2$	(m) (p) (qg) $\Sigma(T)$	(mu)	User meter 2, tariff HT or LT
.....	(m) (p) (qg) $\Sigma(T)$	(mu)
$\Sigma METER11$	(m) (p) (qg) $\Sigma(T)$	(mu)	User meter 11, tariff HT or LT
$\Sigma METER12$	(m) (p) (qg) $\Sigma(T)$	(mu)	User meter 12, tariff HT or LT

(m): Short description of basic quantity, e.g. „P“

(p): Phase reference of the selected quantity, e.g. „1“

(q): Quadrant information, e.g. „I+IV“

(qg): Graphical quadrant information, e.g. 

(T): Associated tariff, e.g. „HT“ or „LT“





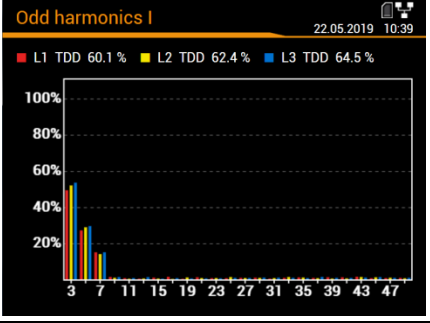
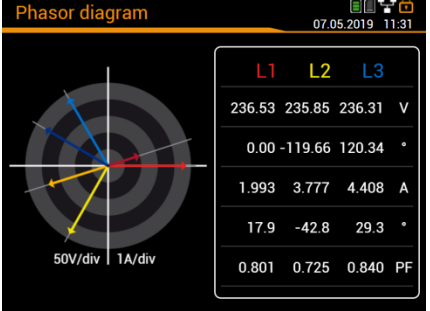

(mu): Unit of basic quantity

Graphical measurement displays





Name	Presentation	Description
Px_TRIANGLE		<p>Graphic of the power triangle consisting of:</p> <ul style="list-style-type: none"> Active, reactive and apparent power P_x, Q_x, S_x Distortion reactive power D_x Fundamental reactive power $Q_x(H1)$ $\cos(\varphi)$ of fundamental Active power factor PF_x
PF_MIN		Graphic: Minimum active power factor PF in all 4 quadrants
Cφ_MIN	(as PF_MIN)	Graphic: Minimum $\cos(\varphi)$ in all 4 quadrants
$I > m.1 / m.2$		<p>Graphic: Present measurements and states of fault-current monitoring</p> <p><i>Data available only, if the device is equipped with at least one optional fault-current module.</i></p>
$\vartheta m.1 / m.2$		<p>Graphic: Present measurements and states of temperature monitoring</p> <p><i>Data available only, if the device is equipped with at least one temperature module.</i></p>
MT_P_I_IV		<p>Graphic mean-value P (I+IV)</p> <p>Trend, last 5 interval values, minimum and maximum</p>
MT_P_II_III	(as MT_P_I_IV)	Graphic mean-value P (II+III) Trend, last 5 interval values, minimum and maximum
MT_Q_I_II	(as MT_P_I_IV)	Graphic mean-value Q (I+II) Trend, last 5 interval values, minimum and maximum
MT_Q_III_IV	(as MT_P_I_IV)	Graphic mean-value Q (III+IV) Trend, last 5 interval values, minimum and maximum
MT_S	(as MT_P_I_IV)	Graphic mean-value S: Trend, last 5 interval values, minimum and maximum

HO_IX	 <p>Odd harmonics I 22.05.2019 10:39 L1 TDD 60.1% L2 TDD 62.4% L3 TDD 64.5%</p>	Graphic: Odd harmonics 3 rd up to 49 th + Total Harmonic Distortion of all currents																														
HO_UX	(as HO_IX)	Graphic: Odd harmonics 3 rd up to 49 th + Total Harmonic Distortion of all voltages																														
HE_IX	(as HO_IX)	Graphic: Even harmonics 2 nd up to 50 th + Total Harmonic Distortion of all currents																														
HE_UX	(as HO_IX)	Graphic: Even harmonics 2 nd up to 50 th + Total Harmonic Distortion of all voltages																														
HO_UX_MAX	(as HO_IX)	Graphic: Maximum values odd harmonics 3 rd up to 49 th + Total Harmonic Distortion of all voltages																														
HO_IX_MAX	(as HO_IX)	Graphic: Maximum values odd harmonics 3 rd up to 49 th + Total Harmonic Distortion of all currents																														
HE_UX_MAX	(as HO_IX)	Graphic: Maximum values even harmonics 2 nd up to 50 th + Total Harmonic Distortion of all voltages																														
HE_IX_MAX	(as HO_IX)	Graphic: Maximum values even harmonics 2 nd up to 50 th + Total Harmonic Distortion of all currents																														
PHASOR	 <p>Phasor diagram 07.05.2019 11:31</p> <table border="1"> <thead> <tr> <th></th> <th>L1</th> <th>L2</th> <th>L3</th> <th></th> </tr> </thead> <tbody> <tr> <td></td> <td>236.53</td> <td>235.85</td> <td>236.31</td> <td>V</td> </tr> <tr> <td></td> <td>0.00</td> <td>-119.66</td> <td>120.34</td> <td>°</td> </tr> <tr> <td></td> <td>1.993</td> <td>3.777</td> <td>4.408</td> <td>A</td> </tr> <tr> <td></td> <td>17.9</td> <td>-42.8</td> <td>29.3</td> <td>°</td> </tr> <tr> <td></td> <td>0.801</td> <td>0.725</td> <td>0.840</td> <td>PF</td> </tr> </tbody> </table> <p>50V/div 1A/div</p>		L1	L2	L3			236.53	235.85	236.31	V		0.00	-119.66	120.34	°		1.993	3.777	4.408	A		17.9	-42.8	29.3	°		0.801	0.725	0.840	PF	Graphic: All current and voltage phasors with present load situation
	L1	L2	L3																													
	236.53	235.85	236.31	V																												
	0.00	-119.66	120.34	°																												
	1.993	3.777	4.408	A																												
	17.9	-42.8	29.3	°																												
	0.801	0.725	0.840	PF																												

B1 Display matrices for single phase system

Display menu	Corresponding matrix														
 Instantaneous values	<table border="1"> <tr> <td>U UNE F</td> <td>U_MM UNE_MAX F_MM</td> </tr> <tr> <td>I IN IMS</td> <td>I_MAX IN_MAX</td> </tr> <tr> <td>P Q S PF</td> <td>P_MAX Q_MAX S_MAX</td> </tr> <tr> <td>P_TRIANGLE</td> <td></td> </tr> <tr> <td>PF_MIN</td> <td>Cφ_MIN</td> </tr> <tr> <td>I> 1.1 / 1.2</td> <td>I> 2.1 / 2.2</td> </tr> <tr> <td>I∅ 1.1 / 1.2</td> <td>I∅ 2.1 / 2.2</td> </tr> </table>	U UNE F	U_MM UNE_MAX F_MM	I IN IMS	I_MAX IN_MAX	P Q S PF	P_MAX Q_MAX S_MAX	P_TRIANGLE		PF_MIN	Cφ_MIN	I> 1.1 / 1.2	I> 2.1 / 2.2	I∅ 1.1 / 1.2	I∅ 2.1 / 2.2
U UNE F	U_MM UNE_MAX F_MM														
I IN IMS	I_MAX IN_MAX														
P Q S PF	P_MAX Q_MAX S_MAX														
P_TRIANGLE															
PF_MIN	Cφ_MIN														
I> 1.1 / 1.2	I> 2.1 / 2.2														
I∅ 1.1 / 1.2	I∅ 2.1 / 2.2														
 Energy Meter contents Standard meters	<table border="1"> <tr> <td> ΣP_I_IV_HT ΣP_I_IV_NT ΣP_II_III_NT ΣP_II_III_HT ΣQ_I_II_HT ΣQ_I_II_NT ΣQ_III_IV_HT ΣQ_I_II_NT </td> </tr> </table>	ΣP_I_IV_HT ΣP_I_IV_NT ΣP_II_III_NT ΣP_II_III_HT ΣQ_I_II_HT ΣQ_I_II_NT ΣQ_III_IV_HT ΣQ_I_II_NT													
ΣP_I_IV_HT ΣP_I_IV_NT ΣP_II_III_NT ΣP_II_III_HT ΣQ_I_II_HT ΣQ_I_II_NT ΣQ_III_IV_HT ΣQ_I_II_NT															
 Energy Meter contents User meters	<table border="1"> <tr> <td> ΣMETER1 ΣMETER2 ΣMETER3 ΣMETER4 ΣMETER5 ΣMETER6 ΣMETER7 ΣMETER8 ΣMETER9 ΣMETER10 ΣMETER11 ΣMETER12 </td> </tr> </table>	ΣMETER1 ΣMETER2 ΣMETER3 ΣMETER4 ΣMETER5 ΣMETER6 ΣMETER7 ΣMETER8 ΣMETER9 ΣMETER10 ΣMETER11 ΣMETER12													
ΣMETER1 ΣMETER2 ΣMETER3 ΣMETER4 ΣMETER5 ΣMETER6 ΣMETER7 ΣMETER8 ΣMETER9 ΣMETER10 ΣMETER11 ΣMETER12															
 Energy Mean-values Power mean-values + trend	<table border="1"> <tr> <td>MT_P_I_IV</td> <td>MT_P_II_III</td> <td>MT_Q_I_II</td> <td>MT_Q_III_IV</td> <td>MT_S</td> </tr> </table>	MT_P_I_IV	MT_P_II_III	MT_Q_I_II	MT_Q_III_IV	MT_S									
MT_P_I_IV	MT_P_II_III	MT_Q_I_II	MT_Q_III_IV	MT_S											
 Energy Mean-values User mean-values + trend	<table border="1"> <tr> <td>M1 M2 M3 M4</td> <td>TR_M1 TR_M2 TR_M3 TR_M4</td> <td>M1_MM M2_MM M3_MM M4_MM</td> </tr> <tr> <td>M5 M6 M7 M8</td> <td>TR_M5 TR_M6 TR_M7 TR_M8</td> <td>M5_MM M6_MM M7_MM M8_MM</td> </tr> <tr> <td>M9 M10 M11 M12</td> <td>TR_M9 TR_M10 TR_M11 TR_M12</td> <td>M9_MM M10_MM M11_MM M12_MM</td> </tr> </table>	M1 M2 M3 M4	TR_M1 TR_M2 TR_M3 TR_M4	M1_MM M2_MM M3_MM M4_MM	M5 M6 M7 M8	TR_M5 TR_M6 TR_M7 TR_M8	M5_MM M6_MM M7_MM M8_MM	M9 M10 M11 M12	TR_M9 TR_M10 TR_M11 TR_M12	M9_MM M10_MM M11_MM M12_MM					
M1 M2 M3 M4	TR_M1 TR_M2 TR_M3 TR_M4	M1_MM M2_MM M3_MM M4_MM													
M5 M6 M7 M8	TR_M5 TR_M6 TR_M7 TR_M8	M5_MM M6_MM M7_MM M8_MM													
M9 M10 M11 M12	TR_M9 TR_M10 TR_M11 TR_M12	M9_MM M10_MM M11_MM M12_MM													
 Energy Bimetal current	<table border="1"> <tr> <td> IB1 IB2 IB1_MAX IB2_MAX </td> </tr> </table>	IB1 IB2 IB1_MAX IB2_MAX													
IB1 IB2 IB1_MAX IB2_MAX															







B2 Display matrices for split-phase (two-phase) systems

Display menu	Corresponding matrix																																																																
 Instantaneous values	<table border="1"> <tr> <td>U1N</td> <td>U1N_MM</td> <td></td> <td></td> </tr> <tr> <td>U2N</td> <td>U2N_MM</td> <td></td> <td></td> </tr> <tr> <td>U</td> <td>U_MM</td> <td></td> <td></td> </tr> <tr> <td>UNE</td> <td>UNE_MAX</td> <td></td> <td></td> </tr> <tr> <td>I1</td> <td>I1_MAX</td> <td></td> <td></td> </tr> <tr> <td>I2</td> <td>I2_MAX</td> <td></td> <td></td> </tr> <tr> <td>IN</td> <td>IN_MAX</td> <td></td> <td></td> </tr> <tr> <td>IPE</td> <td>IPE_MAX</td> <td></td> <td></td> </tr> <tr> <td>P</td> <td>P1</td> <td>P_MAX</td> <td>P1_MAX</td> </tr> <tr> <td>Q</td> <td>P2</td> <td>Q_MAX</td> <td>P2_MAX</td> </tr> <tr> <td>F</td> <td>Q1</td> <td>S_MAX</td> <td>Q1_MAX</td> </tr> <tr> <td>PF</td> <td>Q2</td> <td>F_MM</td> <td>Q2_MAX</td> </tr> <tr> <td>P_TRIANGLE</td> <td>P1_TRIANGLE</td> <td>P2_TRIANGLE</td> <td></td> </tr> <tr> <td>PF_MIN</td> <td>Cφ_MIN</td> <td></td> <td></td> </tr> <tr> <td> > 1.1 / 1.2</td> <td> > 2.1 / 2.2</td> <td></td> <td></td> </tr> <tr> <td>∅ 1.1 / 1.2</td> <td>∅ 2.1 / 2.2</td> <td></td> <td></td> </tr> </table>	U1N	U1N_MM			U2N	U2N_MM			U	U_MM			UNE	UNE_MAX			I1	I1_MAX			I2	I2_MAX			IN	IN_MAX			IPE	IPE_MAX			P	P1	P_MAX	P1_MAX	Q	P2	Q_MAX	P2_MAX	F	Q1	S_MAX	Q1_MAX	PF	Q2	F_MM	Q2_MAX	P_TRIANGLE	P1_TRIANGLE	P2_TRIANGLE		PF_MIN	Cφ_MIN			> 1.1 / 1.2	> 2.1 / 2.2			∅ 1.1 / 1.2	∅ 2.1 / 2.2		
U1N	U1N_MM																																																																
U2N	U2N_MM																																																																
U	U_MM																																																																
UNE	UNE_MAX																																																																
I1	I1_MAX																																																																
I2	I2_MAX																																																																
IN	IN_MAX																																																																
IPE	IPE_MAX																																																																
P	P1	P_MAX	P1_MAX																																																														
Q	P2	Q_MAX	P2_MAX																																																														
F	Q1	S_MAX	Q1_MAX																																																														
PF	Q2	F_MM	Q2_MAX																																																														
P_TRIANGLE	P1_TRIANGLE	P2_TRIANGLE																																																															
PF_MIN	Cφ_MIN																																																																
> 1.1 / 1.2	> 2.1 / 2.2																																																																
∅ 1.1 / 1.2	∅ 2.1 / 2.2																																																																
 Energy Meter contents Standard meters	<table border="1"> <tr> <td>ΣP_I_IV_HT</td> </tr> <tr> <td>ΣP_I_IV_NT</td> </tr> <tr> <td>ΣP_II_III_NT</td> </tr> <tr> <td>ΣP_II_III_HT</td> </tr> <tr> <td>ΣQ_I_II_HT</td> </tr> <tr> <td>ΣQ_I_II_NT</td> </tr> <tr> <td>ΣQ_III_IV_HT</td> </tr> <tr> <td>ΣQ_I_II_NT</td> </tr> </table>	ΣP_I_IV_HT	ΣP_I_IV_NT	ΣP_II_III_NT	ΣP_II_III_HT	ΣQ_I_II_HT	ΣQ_I_II_NT	ΣQ_III_IV_HT	ΣQ_I_II_NT																																																								
ΣP_I_IV_HT																																																																	
ΣP_I_IV_NT																																																																	
ΣP_II_III_NT																																																																	
ΣP_II_III_HT																																																																	
ΣQ_I_II_HT																																																																	
ΣQ_I_II_NT																																																																	
ΣQ_III_IV_HT																																																																	
ΣQ_I_II_NT																																																																	
 Energy Meter contents User meters	<table border="1"> <tr> <td>ΣMETER1</td> </tr> <tr> <td>ΣMETER2</td> </tr> <tr> <td>ΣMETER3</td> </tr> <tr> <td>ΣMETER4</td> </tr> <tr> <td>ΣMETER5</td> </tr> <tr> <td>ΣMETER6</td> </tr> <tr> <td>ΣMETER7</td> </tr> <tr> <td>ΣMETER8</td> </tr> <tr> <td>ΣMETER9</td> </tr> <tr> <td>ΣMETER10</td> </tr> <tr> <td>ΣMETER11</td> </tr> <tr> <td>ΣMETER12</td> </tr> </table>	ΣMETER1	ΣMETER2	ΣMETER3	ΣMETER4	ΣMETER5	ΣMETER6	ΣMETER7	ΣMETER8	ΣMETER9	ΣMETER10	ΣMETER11	ΣMETER12																																																				
ΣMETER1																																																																	
ΣMETER2																																																																	
ΣMETER3																																																																	
ΣMETER4																																																																	
ΣMETER5																																																																	
ΣMETER6																																																																	
ΣMETER7																																																																	
ΣMETER8																																																																	
ΣMETER9																																																																	
ΣMETER10																																																																	
ΣMETER11																																																																	
ΣMETER12																																																																	
 Energy Mean-values Power mean-values + trend	<table border="1"> <tr> <td>MT_P_I_IV</td> <td>MT_P_II_III</td> <td>MT_Q_I_II</td> <td>MT_Q_III_IV</td> <td>MT_S</td> </tr> </table>	MT_P_I_IV	MT_P_II_III	MT_Q_I_II	MT_Q_III_IV	MT_S																																																											
MT_P_I_IV	MT_P_II_III	MT_Q_I_II	MT_Q_III_IV	MT_S																																																													
 Energy Mean-values User mean-values + trend	<table border="1"> <tr> <td>M1</td> <td>TR_M1</td> <td>M1_MM</td> </tr> <tr> <td>M2</td> <td>TR_M2</td> <td>M2_MM</td> </tr> <tr> <td>M3</td> <td>TR_M3</td> <td>M3_MM</td> </tr> <tr> <td>M4</td> <td>TR_M4</td> <td>M4_MM</td> </tr> <tr> <td>M5</td> <td>TR_M5</td> <td>M5_MM</td> </tr> <tr> <td>M6</td> <td>TR_M6</td> <td>M6_MM</td> </tr> <tr> <td>M7</td> <td>TR_M7</td> <td>M7_MM</td> </tr> <tr> <td>M8</td> <td>TR_M8</td> <td>M8_MM</td> </tr> <tr> <td>M9</td> <td>TR_M9</td> <td>M9_MM</td> </tr> <tr> <td>M10</td> <td>TR_M10</td> <td>M10_MM</td> </tr> <tr> <td>M11</td> <td>TR_M11</td> <td>M11_MM</td> </tr> <tr> <td>M12</td> <td>TR_M12</td> <td>M12_MM</td> </tr> </table>	M1	TR_M1	M1_MM	M2	TR_M2	M2_MM	M3	TR_M3	M3_MM	M4	TR_M4	M4_MM	M5	TR_M5	M5_MM	M6	TR_M6	M6_MM	M7	TR_M7	M7_MM	M8	TR_M8	M8_MM	M9	TR_M9	M9_MM	M10	TR_M10	M10_MM	M11	TR_M11	M11_MM	M12	TR_M12	M12_MM																												
M1	TR_M1	M1_MM																																																															
M2	TR_M2	M2_MM																																																															
M3	TR_M3	M3_MM																																																															
M4	TR_M4	M4_MM																																																															
M5	TR_M5	M5_MM																																																															
M6	TR_M6	M6_MM																																																															
M7	TR_M7	M7_MM																																																															
M8	TR_M8	M8_MM																																																															
M9	TR_M9	M9_MM																																																															
M10	TR_M10	M10_MM																																																															
M11	TR_M11	M11_MM																																																															
M12	TR_M12	M12_MM																																																															
 Energy Bimetal current	<table border="1"> <tr> <td>IB1</td> </tr> <tr> <td>IB2</td> </tr> <tr> <td>IB1_MAX</td> </tr> <tr> <td>IB2_MAX</td> </tr> </table>	IB1	IB2	IB1_MAX	IB2_MAX																																																												
IB1																																																																	
IB2																																																																	
IB1_MAX																																																																	
IB2_MAX																																																																	

B3 Display matrices for 3-wire system, balanced load

Display menu	Corresponding matrix																												
<div style="border: 1px solid green; padding: 2px; display: inline-block; margin-bottom: 10px;"> Instantaneous values </div>	<table border="1" style="width: 100%; border-collapse: collapse;"> <tr> <td style="width: 25%;">U12 U23 U31 F</td> <td style="width: 25%; background-color: #f4a460;">UNE UNE_MAX 1)</td> <td style="width: 25%;">U12_MM U23_MM U31_MM F_MM</td> <td style="width: 25%;">UR1 UR2 UR2R1 UR21_MAX</td> </tr> <tr> <td>I I_MAX IMS</td> <td colspan="3">1) Only if measurement of homopolar voltage has been activated</td> </tr> <tr> <td>P Q S PF</td> <td colspan="3">P_MAX Q_MAX S_MAX</td> </tr> <tr> <td>P_TRIANGLE</td> <td colspan="3"></td> </tr> <tr> <td>PF_MIN</td> <td colspan="3">Cφ_MIN</td> </tr> <tr> <td> > 1.1 / 1.2</td> <td colspan="3"> > 2.1 / 2.2</td> </tr> <tr> <td>∅ 1.1 / 1.2</td> <td colspan="3">∅ 2.1 / 2.2</td> </tr> </table>	U12 U23 U31 F	UNE UNE_MAX 1)	U12_MM U23_MM U31_MM F_MM	UR1 UR2 UR2R1 UR21_MAX	I I_MAX IMS	1) Only if measurement of homopolar voltage has been activated			P Q S PF	P_MAX Q_MAX S_MAX			P_TRIANGLE				PF_MIN	Cφ_MIN			> 1.1 / 1.2	> 2.1 / 2.2			∅ 1.1 / 1.2	∅ 2.1 / 2.2		
U12 U23 U31 F	UNE UNE_MAX 1)	U12_MM U23_MM U31_MM F_MM	UR1 UR2 UR2R1 UR21_MAX																										
I I_MAX IMS	1) Only if measurement of homopolar voltage has been activated																												
P Q S PF	P_MAX Q_MAX S_MAX																												
P_TRIANGLE																													
PF_MIN	Cφ_MIN																												
> 1.1 / 1.2	> 2.1 / 2.2																												
∅ 1.1 / 1.2	∅ 2.1 / 2.2																												
<div style="border: 1px solid green; padding: 2px; display: inline-block; margin-bottom: 5px;"> Energy </div> <div style="border: 1px solid green; padding: 2px; display: inline-block; margin-left: 20px; margin-bottom: 5px;">Meter contents</div> <div style="border: 1px solid green; padding: 2px; display: inline-block; margin-left: 20px;">Standard meters</div>	<table border="1" style="width: 100%; border-collapse: collapse;"> <tr> <td>ΣP_I_IV_HT ΣP_I_IV_NT ΣP_II_III_NT ΣP_II_III_HT ΣQ_I_II_HT ΣQ_I_II_NT ΣQ_III_IV_HT ΣQ_I_II_NT</td> </tr> </table>	ΣP_I_IV_HT ΣP_I_IV_NT ΣP_II_III_NT ΣP_II_III_HT ΣQ_I_II_HT ΣQ_I_II_NT ΣQ_III_IV_HT ΣQ_I_II_NT																											
ΣP_I_IV_HT ΣP_I_IV_NT ΣP_II_III_NT ΣP_II_III_HT ΣQ_I_II_HT ΣQ_I_II_NT ΣQ_III_IV_HT ΣQ_I_II_NT																													
<div style="border: 1px solid green; padding: 2px; display: inline-block; margin-bottom: 5px;"> Energy </div> <div style="border: 1px solid green; padding: 2px; display: inline-block; margin-left: 20px; margin-bottom: 5px;">Meter contents</div> <div style="border: 1px solid green; padding: 2px; display: inline-block; margin-left: 20px;">User meters</div>	<table border="1" style="width: 100%; border-collapse: collapse;"> <tr> <td>ΣMETER1 ΣMETER2 ΣMETER3 ΣMETER4 ΣMETER5 ΣMETER6 ΣMETER7 ΣMETER8 ΣMETER9 ΣMETER10 ΣMETER11 ΣMETER12</td> </tr> </table>	ΣMETER1 ΣMETER2 ΣMETER3 ΣMETER4 ΣMETER5 ΣMETER6 ΣMETER7 ΣMETER8 ΣMETER9 ΣMETER10 ΣMETER11 ΣMETER12																											
ΣMETER1 ΣMETER2 ΣMETER3 ΣMETER4 ΣMETER5 ΣMETER6 ΣMETER7 ΣMETER8 ΣMETER9 ΣMETER10 ΣMETER11 ΣMETER12																													
<div style="border: 1px solid green; padding: 2px; display: inline-block; margin-bottom: 5px;"> Energy </div> <div style="border: 1px solid green; padding: 2px; display: inline-block; margin-left: 20px; margin-bottom: 5px;">Mean-values</div> <div style="border: 1px solid green; padding: 2px; display: inline-block; margin-left: 20px;">Power mean-values + trend</div>	<table border="1" style="width: 100%; border-collapse: collapse;"> <tr> <td style="width: 20%;">MT_P_I_IV</td> <td style="width: 20%;">MT_P_II_III</td> <td style="width: 20%;">MT_Q_I_II</td> <td style="width: 20%;">MT_Q_III_IV</td> <td style="width: 20%;">MT_S</td> </tr> </table>	MT_P_I_IV	MT_P_II_III	MT_Q_I_II	MT_Q_III_IV	MT_S																							
MT_P_I_IV	MT_P_II_III	MT_Q_I_II	MT_Q_III_IV	MT_S																									
<div style="border: 1px solid green; padding: 2px; display: inline-block; margin-bottom: 5px;"> Energy </div> <div style="border: 1px solid green; padding: 2px; display: inline-block; margin-left: 20px; margin-bottom: 5px;">Mean-values</div> <div style="border: 1px solid green; padding: 2px; display: inline-block; margin-left: 20px;">User mean-values + trend</div>	<table border="1" style="width: 100%; border-collapse: collapse;"> <tr> <td style="width: 33%;">M1 M2 M3 M4</td> <td style="width: 33%;">TR_M1 TR_M2 TR_M3 TR_M4</td> <td style="width: 33%;">M1_MM M2_MM M3_MM M4_MM</td> </tr> <tr> <td>M5 M6 M7 M8</td> <td>TR_M5 TR_M6 TR_M7 TR_M8</td> <td>M5_MM M6_MM M7_MM M8_MM</td> </tr> <tr> <td>M9 M10 M11 M12</td> <td>TR_M9 TR_M10 TR_M11 TR_M12</td> <td>M9_MM M10_MM M11_MM M12_MM</td> </tr> </table>	M1 M2 M3 M4	TR_M1 TR_M2 TR_M3 TR_M4	M1_MM M2_MM M3_MM M4_MM	M5 M6 M7 M8	TR_M5 TR_M6 TR_M7 TR_M8	M5_MM M6_MM M7_MM M8_MM	M9 M10 M11 M12	TR_M9 TR_M10 TR_M11 TR_M12	M9_MM M10_MM M11_MM M12_MM																			
M1 M2 M3 M4	TR_M1 TR_M2 TR_M3 TR_M4	M1_MM M2_MM M3_MM M4_MM																											
M5 M6 M7 M8	TR_M5 TR_M6 TR_M7 TR_M8	M5_MM M6_MM M7_MM M8_MM																											
M9 M10 M11 M12	TR_M9 TR_M10 TR_M11 TR_M12	M9_MM M10_MM M11_MM M12_MM																											
<div style="border: 1px solid green; padding: 2px; display: inline-block; margin-bottom: 5px;"> Energy </div> <div style="border: 1px solid green; padding: 2px; display: inline-block; margin-left: 20px;">Bimetal current</div>	<table border="1" style="width: 100%; border-collapse: collapse;"> <tr> <td>IB IB_MAX</td> </tr> </table>	IB IB_MAX																											
IB IB_MAX																													







B4 Display matrices for 3-wire system, balanced load, phase shift

Display menu	Corresponding matrix																																				
 Instantaneous values	<table border="1"> <tr><td>U</td><td>U_MM</td></tr> <tr><td>I</td><td>I_MAX</td></tr> <tr><td>P</td><td>P_MAX</td></tr> <tr><td>F</td><td>F_MM</td></tr> <tr><td>P</td><td>P_MAX</td></tr> <tr><td>Q</td><td>Q_MAX</td></tr> <tr><td>S</td><td>S_MAX</td></tr> <tr><td>PF</td><td></td></tr> <tr><td>P_TRIANGLE</td><td></td></tr> <tr><td>PF_MIN</td><td>Cφ_MIN</td></tr> <tr><td>I> 1.1 / 1.2</td><td>I> 2.1 / 2.2</td></tr> <tr><td>ϑ 1.1 / 1.2</td><td>ϑ 2.1 / 2.2</td></tr> </table>	U	U_MM	I	I_MAX	P	P_MAX	F	F_MM	P	P_MAX	Q	Q_MAX	S	S_MAX	PF		P_TRIANGLE		PF_MIN	Cφ_MIN	I> 1.1 / 1.2	I> 2.1 / 2.2	ϑ 1.1 / 1.2	ϑ 2.1 / 2.2												
U	U_MM																																				
I	I_MAX																																				
P	P_MAX																																				
F	F_MM																																				
P	P_MAX																																				
Q	Q_MAX																																				
S	S_MAX																																				
PF																																					
P_TRIANGLE																																					
PF_MIN	Cφ_MIN																																				
I> 1.1 / 1.2	I> 2.1 / 2.2																																				
ϑ 1.1 / 1.2	ϑ 2.1 / 2.2																																				
 Energy Meter contents Standard meters	<table border="1"> <tr><td>ΣP_I_IV_HT</td></tr> <tr><td>ΣP_I_IV_NT</td></tr> <tr><td>ΣP_II_III_NT</td></tr> <tr><td>ΣP_II_III_HT</td></tr> <tr><td>ΣQ_I_II_HT</td></tr> <tr><td>ΣQ_I_II_NT</td></tr> <tr><td>ΣQ_III_IV_HT</td></tr> <tr><td>ΣQ_I_II_NT</td></tr> </table>	ΣP_I_IV_HT	ΣP_I_IV_NT	ΣP_II_III_NT	ΣP_II_III_HT	ΣQ_I_II_HT	ΣQ_I_II_NT	ΣQ_III_IV_HT	ΣQ_I_II_NT																												
ΣP_I_IV_HT																																					
ΣP_I_IV_NT																																					
ΣP_II_III_NT																																					
ΣP_II_III_HT																																					
ΣQ_I_II_HT																																					
ΣQ_I_II_NT																																					
ΣQ_III_IV_HT																																					
ΣQ_I_II_NT																																					
 Energy Meter contents User meters	<table border="1"> <tr><td>ΣMETER1</td></tr> <tr><td>ΣMETER2</td></tr> <tr><td>ΣMETER3</td></tr> <tr><td>ΣMETER4</td></tr> <tr><td>ΣMETER5</td></tr> <tr><td>ΣMETER6</td></tr> <tr><td>ΣMETER7</td></tr> <tr><td>ΣMETER8</td></tr> <tr><td>ΣMETER9</td></tr> <tr><td>ΣMETER10</td></tr> <tr><td>ΣMETER11</td></tr> <tr><td>ΣMETER12</td></tr> </table>	ΣMETER1	ΣMETER2	ΣMETER3	ΣMETER4	ΣMETER5	ΣMETER6	ΣMETER7	ΣMETER8	ΣMETER9	ΣMETER10	ΣMETER11	ΣMETER12																								
ΣMETER1																																					
ΣMETER2																																					
ΣMETER3																																					
ΣMETER4																																					
ΣMETER5																																					
ΣMETER6																																					
ΣMETER7																																					
ΣMETER8																																					
ΣMETER9																																					
ΣMETER10																																					
ΣMETER11																																					
ΣMETER12																																					
 Energy Mean-values Power mean-values + trend	<table border="1"> <tr> <td>MT_P_I_IV</td> <td>MT_P_II_III</td> <td>MT_Q_I_II</td> <td>MT_Q_III_IV</td> <td>MT_S</td> </tr> </table>	MT_P_I_IV	MT_P_II_III	MT_Q_I_II	MT_Q_III_IV	MT_S																															
MT_P_I_IV	MT_P_II_III	MT_Q_I_II	MT_Q_III_IV	MT_S																																	
 Energy Mean-values User mean-values + trend	<table border="1"> <tr><td>M1</td><td>TR_M1</td><td>M1_MM</td></tr> <tr><td>M2</td><td>TR_M2</td><td>M2_MM</td></tr> <tr><td>M3</td><td>TR_M3</td><td>M3_MM</td></tr> <tr><td>M4</td><td>TR_M4</td><td>M4_MM</td></tr> <tr><td>M5</td><td>TR_M5</td><td>M5_MM</td></tr> <tr><td>M6</td><td>TR_M6</td><td>M6_MM</td></tr> <tr><td>M7</td><td>TR_M7</td><td>M7_MM</td></tr> <tr><td>M8</td><td>TR_M8</td><td>M8_MM</td></tr> <tr><td>M9</td><td>TR_M9</td><td>M9_MM</td></tr> <tr><td>M10</td><td>TR_M10</td><td>M10_MM</td></tr> <tr><td>M11</td><td>TR_M11</td><td>M11_MM</td></tr> <tr><td>M12</td><td>TR_M12</td><td>M12_MM</td></tr> </table>	M1	TR_M1	M1_MM	M2	TR_M2	M2_MM	M3	TR_M3	M3_MM	M4	TR_M4	M4_MM	M5	TR_M5	M5_MM	M6	TR_M6	M6_MM	M7	TR_M7	M7_MM	M8	TR_M8	M8_MM	M9	TR_M9	M9_MM	M10	TR_M10	M10_MM	M11	TR_M11	M11_MM	M12	TR_M12	M12_MM
M1	TR_M1	M1_MM																																			
M2	TR_M2	M2_MM																																			
M3	TR_M3	M3_MM																																			
M4	TR_M4	M4_MM																																			
M5	TR_M5	M5_MM																																			
M6	TR_M6	M6_MM																																			
M7	TR_M7	M7_MM																																			
M8	TR_M8	M8_MM																																			
M9	TR_M9	M9_MM																																			
M10	TR_M10	M10_MM																																			
M11	TR_M11	M11_MM																																			
M12	TR_M12	M12_MM																																			
 Energy Bimetal current	<table border="1"> <tr><td>IB</td></tr> <tr><td>IB_MAX</td></tr> </table>	IB	IB_MAX																																		
IB																																					
IB_MAX																																					







B5 Display matrices for 3-wire systems, unbalanced load

Display menu	Corresponding matrix																		
<div style="border: 1px solid green; padding: 2px; display: inline-block; margin-bottom: 10px;"> Instantaneous values </div>	<table border="1" style="width: 100%; border-collapse: collapse;"> <tr> <td style="width: 25%;">U12 U23 U31 F</td> <td style="width: 25%; background-color: #f9cb9c;">UNE UNE_MAX 1)</td> <td style="width: 25%;">U12_MM U23_MM U31_MM F_MM</td> <td style="width: 25%;">UR1 UR2 UR2R1 UR21_MAX</td> </tr> <tr> <td>I1 I2 I3 IPE</td> <td>I1_MAX I2_MAX I3_MAX IPE_MAX</td> <td>IR1 IR2 IR2R1 IR21_MAX</td> <td></td> </tr> <tr> <td>P Q S PF P_TRIANGLE</td> <td>P_MAX Q_MAX S_MAX</td> <td colspan="2" rowspan="4" style="vertical-align: top; padding-left: 10px;">1) Only if measurement of homopolar voltage has been activated</td> </tr> <tr> <td>PF_MIN</td> <td>Cφ_MIN</td> </tr> <tr> <td>I > 1.1 / 1.2</td> <td>I > 2.1 / 2.2</td> </tr> <tr> <td>I ≠ 1.1 / 1.2</td> <td>I ≠ 2.1 / 2.2</td> </tr> </table>	U12 U23 U31 F	UNE UNE_MAX 1)	U12_MM U23_MM U31_MM F_MM	UR1 UR2 UR2R1 UR21_MAX	I1 I2 I3 IPE	I1_MAX I2_MAX I3_MAX IPE_MAX	IR1 IR2 IR2R1 IR21_MAX		P Q S PF P_TRIANGLE	P_MAX Q_MAX S_MAX	1) Only if measurement of homopolar voltage has been activated		PF_MIN	Cφ_MIN	I > 1.1 / 1.2	I > 2.1 / 2.2	I ≠ 1.1 / 1.2	I ≠ 2.1 / 2.2
U12 U23 U31 F	UNE UNE_MAX 1)	U12_MM U23_MM U31_MM F_MM	UR1 UR2 UR2R1 UR21_MAX																
I1 I2 I3 IPE	I1_MAX I2_MAX I3_MAX IPE_MAX	IR1 IR2 IR2R1 IR21_MAX																	
P Q S PF P_TRIANGLE	P_MAX Q_MAX S_MAX	1) Only if measurement of homopolar voltage has been activated																	
PF_MIN	Cφ_MIN																		
I > 1.1 / 1.2	I > 2.1 / 2.2																		
I ≠ 1.1 / 1.2	I ≠ 2.1 / 2.2																		
<div style="border: 1px solid green; padding: 2px; display: inline-block; margin-bottom: 5px;"> Energy </div> <div style="border: 1px solid green; padding: 2px; display: inline-block; margin-left: 20px; margin-bottom: 5px;">Meter contents</div> <div style="border: 1px solid green; padding: 2px; display: inline-block; margin-left: 20px;">Standard meters</div>	<table border="1" style="width: 100%; border-collapse: collapse;"> <tr> <td style="width: 50%;"> ΣP_I_IV_HT ΣP_I_IV_NT ΣP_II_III_NT ΣP_II_III_HT ΣQ_I_II_HT ΣQ_I_II_NT ΣQ_III_IV_HT ΣQ_I_II_NT </td> </tr> </table>	ΣP_I_IV_HT ΣP_I_IV_NT ΣP_II_III_NT ΣP_II_III_HT ΣQ_I_II_HT ΣQ_I_II_NT ΣQ_III_IV_HT ΣQ_I_II_NT																	
ΣP_I_IV_HT ΣP_I_IV_NT ΣP_II_III_NT ΣP_II_III_HT ΣQ_I_II_HT ΣQ_I_II_NT ΣQ_III_IV_HT ΣQ_I_II_NT																			
<div style="border: 1px solid green; padding: 2px; display: inline-block; margin-bottom: 5px;"> Energy </div> <div style="border: 1px solid green; padding: 2px; display: inline-block; margin-left: 20px; margin-bottom: 5px;">Meter contents</div> <div style="border: 1px solid green; padding: 2px; display: inline-block; margin-left: 20px;">User meters</div>	<table border="1" style="width: 100%; border-collapse: collapse;"> <tr> <td style="width: 50%;"> ΣMETER1 ΣMETER2 ΣMETER3 ΣMETER4 ΣMETER5 ΣMETER6 ΣMETER7 ΣMETER8 ΣMETER9 ΣMETER10 ΣMETER11 ΣMETER12 </td> </tr> </table>	ΣMETER1 ΣMETER2 ΣMETER3 ΣMETER4 ΣMETER5 ΣMETER6 ΣMETER7 ΣMETER8 ΣMETER9 ΣMETER10 ΣMETER11 ΣMETER12																	
ΣMETER1 ΣMETER2 ΣMETER3 ΣMETER4 ΣMETER5 ΣMETER6 ΣMETER7 ΣMETER8 ΣMETER9 ΣMETER10 ΣMETER11 ΣMETER12																			
<div style="border: 1px solid green; padding: 2px; display: inline-block; margin-bottom: 5px;"> Energy </div> <div style="border: 1px solid green; padding: 2px; display: inline-block; margin-left: 20px; margin-bottom: 5px;">Mean-values</div> <div style="border: 1px solid green; padding: 2px; display: inline-block; margin-left: 20px;">Power mean-values + trend</div>	<table border="1" style="width: 100%; border-collapse: collapse;"> <tr> <td style="width: 20%;">MT_P_I_IV</td> <td style="width: 20%;">MT_P_II_III</td> <td style="width: 20%;">MT_Q_I_II</td> <td style="width: 20%;">MT_Q_III_IV</td> <td style="width: 20%;">MT_S</td> </tr> </table>	MT_P_I_IV	MT_P_II_III	MT_Q_I_II	MT_Q_III_IV	MT_S													
MT_P_I_IV	MT_P_II_III	MT_Q_I_II	MT_Q_III_IV	MT_S															
<div style="border: 1px solid green; padding: 2px; display: inline-block; margin-bottom: 5px;"> Energy </div> <div style="border: 1px solid green; padding: 2px; display: inline-block; margin-left: 20px; margin-bottom: 5px;">Mean-values</div> <div style="border: 1px solid green; padding: 2px; display: inline-block; margin-left: 20px;">User mean-values + trend</div>	<table border="1" style="width: 100%; border-collapse: collapse;"> <tr> <td style="width: 33%;">M1 M2 M3 M4</td> <td style="width: 33%;">TR_M1 TR_M2 TR_M3 TR_M4</td> <td style="width: 33%;">M1_MM M2_MM M3_MM M4_MM</td> </tr> <tr> <td>M5 M6 M7 M8</td> <td>TR_M5 TR_M6 TR_M7 TR_M8</td> <td>M5_MM M6_MM M7_MM M8_MM</td> </tr> <tr> <td>M9 M10 M11 M12</td> <td>TR_M9 TR_M10 TR_M11 TR_M12</td> <td>M9_MM M10_MM M11_MM M12_MM</td> </tr> </table>	M1 M2 M3 M4	TR_M1 TR_M2 TR_M3 TR_M4	M1_MM M2_MM M3_MM M4_MM	M5 M6 M7 M8	TR_M5 TR_M6 TR_M7 TR_M8	M5_MM M6_MM M7_MM M8_MM	M9 M10 M11 M12	TR_M9 TR_M10 TR_M11 TR_M12	M9_MM M10_MM M11_MM M12_MM									
M1 M2 M3 M4	TR_M1 TR_M2 TR_M3 TR_M4	M1_MM M2_MM M3_MM M4_MM																	
M5 M6 M7 M8	TR_M5 TR_M6 TR_M7 TR_M8	M5_MM M6_MM M7_MM M8_MM																	
M9 M10 M11 M12	TR_M9 TR_M10 TR_M11 TR_M12	M9_MM M10_MM M11_MM M12_MM																	
<div style="border: 1px solid green; padding: 2px; display: inline-block; margin-bottom: 5px;"> Energy </div> <div style="border: 1px solid green; padding: 2px; display: inline-block; margin-left: 20px; margin-bottom: 5px;">Bimetal current</div>	<table border="1" style="width: 100%; border-collapse: collapse;"> <tr> <td style="width: 50%;">IB1 IB2 IB3</td> <td style="width: 50%;">IB1_MAX IB2_MAX IB3_MAX</td> </tr> </table>	IB1 IB2 IB3	IB1_MAX IB2_MAX IB3_MAX																
IB1 IB2 IB3	IB1_MAX IB2_MAX IB3_MAX																		

B6 Display matrices for 3-wire systems, unbalanced load, Aron

Display menu	Corresponding matrix																
 Instantaneous values	<table border="1"> <tr> <td>U12 U23 U31 F</td> <td>UNE UNE_MAX ¹⁾</td> <td>U12_MM U23_MM U31_MM F_MM</td> <td>UR1 UR2 UR2R1 UR21_MAX</td> </tr> <tr> <td>I1 I2 I3 IMS</td> <td>I1_MAX I2_MAX I3_MAX</td> <td colspan="2" rowspan="5">¹⁾ Only if measurement of homopolar voltage has been activated</td> </tr> <tr> <td>P Q S PF</td> <td>P_MAX Q_MAX S_MAX</td> </tr> <tr> <td>P_TRIANGLE</td> <td></td> </tr> <tr> <td>PF_MIN</td> <td>Cφ_MIN</td> </tr> <tr> <td>I > 1.1 / 1.2 I > 2.1 / 2.2</td> <td>I > 2.1 / 2.2 I > 2.1 / 2.2</td> </tr> </table>	U12 U23 U31 F	UNE UNE_MAX ¹⁾	U12_MM U23_MM U31_MM F_MM	UR1 UR2 UR2R1 UR21_MAX	I1 I2 I3 IMS	I1_MAX I2_MAX I3_MAX	¹⁾ Only if measurement of homopolar voltage has been activated		P Q S PF	P_MAX Q_MAX S_MAX	P_TRIANGLE		PF_MIN	Cφ_MIN	I > 1.1 / 1.2 I > 2.1 / 2.2	I > 2.1 / 2.2 I > 2.1 / 2.2
U12 U23 U31 F	UNE UNE_MAX ¹⁾	U12_MM U23_MM U31_MM F_MM	UR1 UR2 UR2R1 UR21_MAX														
I1 I2 I3 IMS	I1_MAX I2_MAX I3_MAX	¹⁾ Only if measurement of homopolar voltage has been activated															
P Q S PF	P_MAX Q_MAX S_MAX																
P_TRIANGLE																	
PF_MIN	Cφ_MIN																
I > 1.1 / 1.2 I > 2.1 / 2.2	I > 2.1 / 2.2 I > 2.1 / 2.2																
 Energy Meter contents Standard meters	<table border="1"> <tr> <td>ΣP_I_IV_HT ΣP_I_IV_NT ΣP_II_III_NT ΣP_II_III_HT ΣQ_I_II_HT ΣQ_I_II_NT ΣQ_III_IV_HT ΣQ_I_II_NT</td> </tr> </table>	ΣP_I_IV_HT ΣP_I_IV_NT ΣP_II_III_NT ΣP_II_III_HT ΣQ_I_II_HT ΣQ_I_II_NT ΣQ_III_IV_HT ΣQ_I_II_NT															
ΣP_I_IV_HT ΣP_I_IV_NT ΣP_II_III_NT ΣP_II_III_HT ΣQ_I_II_HT ΣQ_I_II_NT ΣQ_III_IV_HT ΣQ_I_II_NT																	
 Energy Meter contents User meters	<table border="1"> <tr> <td>ΣMETER1 ΣMETER2 ΣMETER3 ΣMETER4 ΣMETER5 ΣMETER6 ΣMETER7 ΣMETER8 ΣMETER9 ΣMETER10 ΣMETER11 ΣMETER12</td> </tr> </table>	ΣMETER1 ΣMETER2 ΣMETER3 ΣMETER4 ΣMETER5 ΣMETER6 ΣMETER7 ΣMETER8 ΣMETER9 ΣMETER10 ΣMETER11 ΣMETER12															
ΣMETER1 ΣMETER2 ΣMETER3 ΣMETER4 ΣMETER5 ΣMETER6 ΣMETER7 ΣMETER8 ΣMETER9 ΣMETER10 ΣMETER11 ΣMETER12																	
 Energy Mean-values Power mean-values + trend	<table border="1"> <tr> <td>MT_P_I_IV</td> <td>MT_P_II_III</td> <td>MT_Q_I_II</td> <td>MT_Q_III_IV</td> <td>MT_S</td> </tr> </table>	MT_P_I_IV	MT_P_II_III	MT_Q_I_II	MT_Q_III_IV	MT_S											
MT_P_I_IV	MT_P_II_III	MT_Q_I_II	MT_Q_III_IV	MT_S													
 Energy Mean-values User mean-values + trend	<table border="1"> <tr> <td>M1 M2 M3 M4</td> <td>TR_M1 TR_M2 TR_M3 TR_M4</td> <td>M1_MM M2_MM M3_MM M4_MM</td> </tr> <tr> <td>M5 M6 M7 M8</td> <td>TR_M5 TR_M6 TR_M7 TR_M8</td> <td>M5_MM M6_MM M7_MM M8_MM</td> </tr> <tr> <td>M9 M10 M11 M12</td> <td>TR_M9 TR_M10 TR_M11 TR_M12</td> <td>M9_MM M10_MM M11_MM M12_MM</td> </tr> </table>	M1 M2 M3 M4	TR_M1 TR_M2 TR_M3 TR_M4	M1_MM M2_MM M3_MM M4_MM	M5 M6 M7 M8	TR_M5 TR_M6 TR_M7 TR_M8	M5_MM M6_MM M7_MM M8_MM	M9 M10 M11 M12	TR_M9 TR_M10 TR_M11 TR_M12	M9_MM M10_MM M11_MM M12_MM							
M1 M2 M3 M4	TR_M1 TR_M2 TR_M3 TR_M4	M1_MM M2_MM M3_MM M4_MM															
M5 M6 M7 M8	TR_M5 TR_M6 TR_M7 TR_M8	M5_MM M6_MM M7_MM M8_MM															
M9 M10 M11 M12	TR_M9 TR_M10 TR_M11 TR_M12	M9_MM M10_MM M11_MM M12_MM															
 Energy Bimetal current	<table border="1"> <tr> <td>IB1 IB2 IB3</td> <td>IB1_MAX IB2_MAX IB3_MAX</td> </tr> </table>	IB1 IB2 IB3	IB1_MAX IB2_MAX IB3_MAX														
IB1 IB2 IB3	IB1_MAX IB2_MAX IB3_MAX																







B7 Display matrices for 4-wire system, balanced load

Display menu	Corresponding matrix																																				
 Instantaneous values	<table border="1"> <tr> <td>U</td> <td>U_MM</td> </tr> <tr> <td>UNE</td> <td>UNE_MAX</td> </tr> <tr> <td>I</td> <td>I_MAX</td> </tr> <tr> <td>F</td> <td>F_MM</td> </tr> <tr> <td>P</td> <td>P_MAX</td> </tr> <tr> <td>Q</td> <td>Q_MAX</td> </tr> <tr> <td>S</td> <td>S_MAX</td> </tr> <tr> <td>PF</td> <td></td> </tr> <tr> <td>P_TRIANGLE</td> <td></td> </tr> <tr> <td>PF_MIN</td> <td>Cφ_MIN</td> </tr> <tr> <td> > 1.1 / 1.2</td> <td> > 2.1 / 2.2</td> </tr> <tr> <td>∅ 1.1 / 1.2</td> <td>∅ 2.1 / 2.2</td> </tr> </table>	U	U_MM	UNE	UNE_MAX	I	I_MAX	F	F_MM	P	P_MAX	Q	Q_MAX	S	S_MAX	PF		P_TRIANGLE		PF_MIN	Cφ_MIN	> 1.1 / 1.2	> 2.1 / 2.2	∅ 1.1 / 1.2	∅ 2.1 / 2.2												
U	U_MM																																				
UNE	UNE_MAX																																				
I	I_MAX																																				
F	F_MM																																				
P	P_MAX																																				
Q	Q_MAX																																				
S	S_MAX																																				
PF																																					
P_TRIANGLE																																					
PF_MIN	Cφ_MIN																																				
> 1.1 / 1.2	> 2.1 / 2.2																																				
∅ 1.1 / 1.2	∅ 2.1 / 2.2																																				
 Energy Meter contents Standard meters	<table border="1"> <tr> <td>ΣP_I_IV_HT</td> </tr> <tr> <td>ΣP_I_IV_NT</td> </tr> <tr> <td>ΣP_II_III_NT</td> </tr> <tr> <td>ΣP_II_III_HT</td> </tr> <tr> <td>ΣQ_I_II_HT</td> </tr> <tr> <td>ΣQ_I_II_NT</td> </tr> <tr> <td>ΣQ_III_IV_HT</td> </tr> <tr> <td>ΣQ_I_II_NT</td> </tr> </table>	ΣP_I_IV_HT	ΣP_I_IV_NT	ΣP_II_III_NT	ΣP_II_III_HT	ΣQ_I_II_HT	ΣQ_I_II_NT	ΣQ_III_IV_HT	ΣQ_I_II_NT																												
ΣP_I_IV_HT																																					
ΣP_I_IV_NT																																					
ΣP_II_III_NT																																					
ΣP_II_III_HT																																					
ΣQ_I_II_HT																																					
ΣQ_I_II_NT																																					
ΣQ_III_IV_HT																																					
ΣQ_I_II_NT																																					
 Energy Meter contents User meters	<table border="1"> <tr> <td>ΣMETER1</td> </tr> <tr> <td>ΣMETER2</td> </tr> <tr> <td>ΣMETER3</td> </tr> <tr> <td>ΣMETER4</td> </tr> <tr> <td>ΣMETER5</td> </tr> <tr> <td>ΣMETER6</td> </tr> <tr> <td>ΣMETER7</td> </tr> <tr> <td>ΣMETER8</td> </tr> <tr> <td>ΣMETER9</td> </tr> <tr> <td>ΣMETER10</td> </tr> <tr> <td>ΣMETER11</td> </tr> <tr> <td>ΣMETER12</td> </tr> </table>	ΣMETER1	ΣMETER2	ΣMETER3	ΣMETER4	ΣMETER5	ΣMETER6	ΣMETER7	ΣMETER8	ΣMETER9	ΣMETER10	ΣMETER11	ΣMETER12																								
ΣMETER1																																					
ΣMETER2																																					
ΣMETER3																																					
ΣMETER4																																					
ΣMETER5																																					
ΣMETER6																																					
ΣMETER7																																					
ΣMETER8																																					
ΣMETER9																																					
ΣMETER10																																					
ΣMETER11																																					
ΣMETER12																																					
 Energy Mean-values Power mean-values + trend	<table border="1"> <tr> <td>MT_P_I_IV</td> <td>MT_P_II_III</td> <td>MT_Q_I_II</td> <td>MT_Q_III_IV</td> <td>MT_S</td> </tr> </table>	MT_P_I_IV	MT_P_II_III	MT_Q_I_II	MT_Q_III_IV	MT_S																															
MT_P_I_IV	MT_P_II_III	MT_Q_I_II	MT_Q_III_IV	MT_S																																	
 Energy Mean-values User mean-values + trend	<table border="1"> <tr> <td>M1</td> <td>TR_M1</td> <td>M1_MM</td> </tr> <tr> <td>M2</td> <td>TR_M2</td> <td>M2_MM</td> </tr> <tr> <td>M3</td> <td>TR_M3</td> <td>M3_MM</td> </tr> <tr> <td>M4</td> <td>TR_M4</td> <td>M4_MM</td> </tr> <tr> <td>M5</td> <td>TR_M5</td> <td>M5_MM</td> </tr> <tr> <td>M6</td> <td>TR_M6</td> <td>M6_MM</td> </tr> <tr> <td>M7</td> <td>TR_M7</td> <td>M7_MM</td> </tr> <tr> <td>M8</td> <td>TR_M8</td> <td>M8_MM</td> </tr> <tr> <td>M9</td> <td>TR_M9</td> <td>M9_MM</td> </tr> <tr> <td>M10</td> <td>TR_M10</td> <td>M10_MM</td> </tr> <tr> <td>M11</td> <td>TR_M11</td> <td>M11_MM</td> </tr> <tr> <td>M12</td> <td>TR_M12</td> <td>M12_MM</td> </tr> </table>	M1	TR_M1	M1_MM	M2	TR_M2	M2_MM	M3	TR_M3	M3_MM	M4	TR_M4	M4_MM	M5	TR_M5	M5_MM	M6	TR_M6	M6_MM	M7	TR_M7	M7_MM	M8	TR_M8	M8_MM	M9	TR_M9	M9_MM	M10	TR_M10	M10_MM	M11	TR_M11	M11_MM	M12	TR_M12	M12_MM
M1	TR_M1	M1_MM																																			
M2	TR_M2	M2_MM																																			
M3	TR_M3	M3_MM																																			
M4	TR_M4	M4_MM																																			
M5	TR_M5	M5_MM																																			
M6	TR_M6	M6_MM																																			
M7	TR_M7	M7_MM																																			
M8	TR_M8	M8_MM																																			
M9	TR_M9	M9_MM																																			
M10	TR_M10	M10_MM																																			
M11	TR_M11	M11_MM																																			
M12	TR_M12	M12_MM																																			
 Energy Bimetal current	<table border="1"> <tr> <td>IB</td> </tr> <tr> <td>IB_MAX</td> </tr> </table>	IB	IB_MAX																																		
IB																																					
IB_MAX																																					

B8 Display matrices for 4-wire systems, unbalanced load

Display menu	Corresponding matrix																																								
<div style="border: 1px solid green; padding: 2px; display: inline-block; margin-bottom: 10px;"> Instantaneous values </div>	<table border="1" style="width: 100%; border-collapse: collapse;"> <tr> <td>U1N U2N U3N UNE</td> <td>U12 U23 U31 F</td> <td>U1N_MM U2N_MM U3N_MM F_MM</td> <td>U12_MM U23_MM U31_MM UR21_MAX</td> <td>UR1 UR2 U0 UNB_UR2_UR1</td> </tr> <tr> <td>I1 I2 I3 F</td> <td>IN IPE IMS</td> <td>I1_MAX I2_MAX I3_MAX</td> <td>IN_MAX IPE_MAX IR21_MAX</td> <td>IR1 IR2 I0 UNB_IR2_IR1</td> </tr> <tr> <td>P Q S PF</td> <td>P1 P2 P3 P</td> <td>Q1 Q2 Q3 Q</td> <td>S1 S2 S3 S</td> <td>P1_MAX P2_MAX P3_MAX P_MAX</td> </tr> <tr> <td></td> <td></td> <td>Q1_MAX Q2_MAX Q3_MAX Q_MAX</td> <td>S1_MAX S2_MAX S3_MAX S_MAX</td> <td></td> </tr> <tr> <td colspan="2">P_TRIANGLE</td> <td>P1_TRIANGLE</td> <td>P2_TRIANGLE</td> <td>P3_TRIANGLE</td> </tr> <tr> <td colspan="2">PF_MIN</td> <td colspan="3">Cφ_MIN</td> </tr> <tr> <td colspan="2"> > 1.1 / 1.2</td> <td colspan="3">> 2.1 / 2.2</td> </tr> <tr> <td colspan="2">∅ 1.1 / 1.2</td> <td colspan="3">∅ 2.1 / 2.2</td> </tr> </table>	U1N U2N U3N UNE	U12 U23 U31 F	U1N_MM U2N_MM U3N_MM F_MM	U12_MM U23_MM U31_MM UR21_MAX	UR1 UR2 U0 UNB_UR2_UR1	I1 I2 I3 F	IN IPE IMS	I1_MAX I2_MAX I3_MAX	IN_MAX IPE_MAX IR21_MAX	IR1 IR2 I0 UNB_IR2_IR1	P Q S PF	P1 P2 P3 P	Q1 Q2 Q3 Q	S1 S2 S3 S	P1_MAX P2_MAX P3_MAX P_MAX			Q1_MAX Q2_MAX Q3_MAX Q_MAX	S1_MAX S2_MAX S3_MAX S_MAX		P_TRIANGLE		P1_TRIANGLE	P2_TRIANGLE	P3_TRIANGLE	PF_MIN		Cφ_MIN			> 1.1 / 1.2		> 2.1 / 2.2			∅ 1.1 / 1.2		∅ 2.1 / 2.2		
U1N U2N U3N UNE	U12 U23 U31 F	U1N_MM U2N_MM U3N_MM F_MM	U12_MM U23_MM U31_MM UR21_MAX	UR1 UR2 U0 UNB_UR2_UR1																																					
I1 I2 I3 F	IN IPE IMS	I1_MAX I2_MAX I3_MAX	IN_MAX IPE_MAX IR21_MAX	IR1 IR2 I0 UNB_IR2_IR1																																					
P Q S PF	P1 P2 P3 P	Q1 Q2 Q3 Q	S1 S2 S3 S	P1_MAX P2_MAX P3_MAX P_MAX																																					
		Q1_MAX Q2_MAX Q3_MAX Q_MAX	S1_MAX S2_MAX S3_MAX S_MAX																																						
P_TRIANGLE		P1_TRIANGLE	P2_TRIANGLE	P3_TRIANGLE																																					
PF_MIN		Cφ_MIN																																							
> 1.1 / 1.2		> 2.1 / 2.2																																							
∅ 1.1 / 1.2		∅ 2.1 / 2.2																																							
<div style="border: 1px solid green; padding: 2px; display: inline-block; margin-bottom: 5px;"> Energy </div> <div style="border: 1px solid green; padding: 2px; display: inline-block; margin-bottom: 5px; margin-left: 20px;"> Meter contents </div> <div style="border: 1px solid green; padding: 2px; display: inline-block; margin-left: 20px;"> Standard meters </div>	<table border="1" style="width: 100%; border-collapse: collapse;"> <tr> <td>ΣP_I_IV_HT ΣP_I_IV_NT ΣP_II_III_NT ΣP_II_III_HT ΣQ_I_II_HT ΣQ_I_II_NT ΣQ_III_IV_HT ΣQ_I_II_NT</td> </tr> </table>	ΣP_I_IV_HT ΣP_I_IV_NT ΣP_II_III_NT ΣP_II_III_HT ΣQ_I_II_HT ΣQ_I_II_NT ΣQ_III_IV_HT ΣQ_I_II_NT																																							
ΣP_I_IV_HT ΣP_I_IV_NT ΣP_II_III_NT ΣP_II_III_HT ΣQ_I_II_HT ΣQ_I_II_NT ΣQ_III_IV_HT ΣQ_I_II_NT																																									
<div style="border: 1px solid green; padding: 2px; display: inline-block; margin-bottom: 5px;"> Energy </div> <div style="border: 1px solid green; padding: 2px; display: inline-block; margin-left: 20px;"> Meter contents </div> <div style="border: 1px solid green; padding: 2px; display: inline-block; margin-left: 20px;"> User meters </div>	<table border="1" style="width: 100%; border-collapse: collapse;"> <tr> <td>ΣMETER1 ΣMETER2 ΣMETER3 ΣMETER4 ΣMETER5 ΣMETER6 ΣMETER7 ΣMETER8 ΣMETER9 ΣMETER10 ΣMETER11 ΣMETER12</td> </tr> </table>	ΣMETER1 ΣMETER2 ΣMETER3 ΣMETER4 ΣMETER5 ΣMETER6 ΣMETER7 ΣMETER8 ΣMETER9 ΣMETER10 ΣMETER11 ΣMETER12																																							
ΣMETER1 ΣMETER2 ΣMETER3 ΣMETER4 ΣMETER5 ΣMETER6 ΣMETER7 ΣMETER8 ΣMETER9 ΣMETER10 ΣMETER11 ΣMETER12																																									
<div style="border: 1px solid green; padding: 2px; display: inline-block; margin-bottom: 5px;"> Energy </div> <div style="border: 1px solid green; padding: 2px; display: inline-block; margin-left: 20px;"> Mean-values </div> <div style="border: 1px solid green; padding: 2px; display: inline-block; margin-left: 20px;"> Power mean-values + trend </div>	<table border="1" style="width: 100%; border-collapse: collapse;"> <tr> <td>MT_P_I_IV</td> <td>MT_P_II_III</td> <td>MT_Q_I_II</td> <td>MT_Q_III_IV</td> <td>MT_S</td> </tr> </table>	MT_P_I_IV	MT_P_II_III	MT_Q_I_II	MT_Q_III_IV	MT_S																																			
MT_P_I_IV	MT_P_II_III	MT_Q_I_II	MT_Q_III_IV	MT_S																																					
<div style="border: 1px solid green; padding: 2px; display: inline-block; margin-bottom: 5px;"> Energy </div> <div style="border: 1px solid green; padding: 2px; display: inline-block; margin-left: 20px;"> Mean-values </div> <div style="border: 1px solid green; padding: 2px; display: inline-block; margin-left: 20px;"> User mean-values + trend </div>	<table border="1" style="width: 100%; border-collapse: collapse;"> <tr> <td>M1 M2 M3 M4</td> <td>TR_M1 TR_M2 TR_M3 TR_M4</td> <td>M1_MM M2_MM M3_MM M4_MM</td> </tr> <tr> <td>M5 M6 M7 M8</td> <td>TR_M5 TR_M6 TR_M7 TR_M8</td> <td>M5_MM M6_MM M7_MM M8_MM</td> </tr> <tr> <td>M9 M10 M11 M12</td> <td>TR_M9 TR_M10 TR_M11 TR_M12</td> <td>M9_MM M10_MM M11_MM M12_MM</td> </tr> </table>	M1 M2 M3 M4	TR_M1 TR_M2 TR_M3 TR_M4	M1_MM M2_MM M3_MM M4_MM	M5 M6 M7 M8	TR_M5 TR_M6 TR_M7 TR_M8	M5_MM M6_MM M7_MM M8_MM	M9 M10 M11 M12	TR_M9 TR_M10 TR_M11 TR_M12	M9_MM M10_MM M11_MM M12_MM																															
M1 M2 M3 M4	TR_M1 TR_M2 TR_M3 TR_M4	M1_MM M2_MM M3_MM M4_MM																																							
M5 M6 M7 M8	TR_M5 TR_M6 TR_M7 TR_M8	M5_MM M6_MM M7_MM M8_MM																																							
M9 M10 M11 M12	TR_M9 TR_M10 TR_M11 TR_M12	M9_MM M10_MM M11_MM M12_MM																																							
<div style="border: 1px solid green; padding: 2px; display: inline-block; margin-bottom: 5px;"> Energy </div> <div style="border: 1px solid green; padding: 2px; display: inline-block; margin-left: 20px;"> Bimetal current </div>	<table border="1" style="width: 100%; border-collapse: collapse;"> <tr> <td>IB1 IB2 IB3</td> <td>IB1_MAX IB2_MAX IB3_MAX</td> </tr> </table>	IB1 IB2 IB3	IB1_MAX IB2_MAX IB3_MAX																																						
IB1 IB2 IB3	IB1_MAX IB2_MAX IB3_MAX																																								

B9 Display matrices for 4-wire system, unbalanced load, Open-Y

Display menu	Corresponding matrix																																
<div style="border: 1px solid green; padding: 2px; display: inline-block;">  Instantaneous values </div>	<table border="1" style="width: 100%; border-collapse: collapse;"> <tr> <td>U1N U2N U3N UNE</td> <td>U12 U23 U31 F</td> <td>U1N_MM U2N_MM U3N_MM UNE_MAX</td> <td>U12_MM U23_MM U31_MM F_MM</td> </tr> <tr> <td>I1 I2 I3 F</td> <td>IN IPE IMS</td> <td>I1_MAX I2_MAX I3_MAX</td> <td>IN_MAX IPE_MAX IR21_MAX IR1 IR2 I0 UNB_IR2_IR1</td> </tr> <tr> <td>P Q S PF</td> <td>P1 P2 P3 P</td> <td>Q1 Q2 Q3 Q</td> <td>S1 S2 S3 S</td> </tr> <tr> <td></td> <td>P1_MAX P2_MAX P3_MAX P_MAX</td> <td>Q1_MAX Q2_MAX Q3_MAX Q_MAX</td> <td>S1_MAX S2_MAX S3_MAX S_MAX</td> </tr> <tr> <td>P_TRIANGLE</td> <td>P1_TRIANGLE</td> <td>P2_TRIANGLE</td> <td>P3_TRIANGLE</td> </tr> <tr> <td>PF_MIN</td> <td>Cφ_MIN</td> <td></td> <td></td> </tr> <tr> <td> > 1.1 / 1.2</td> <td> > 2.1 / 2.2</td> <td></td> <td></td> </tr> <tr> <td>∅ 1.1 / 1.2</td> <td>∅ 2.1 / 2.2</td> <td></td> <td></td> </tr> </table>	U1N U2N U3N UNE	U12 U23 U31 F	U1N_MM U2N_MM U3N_MM UNE_MAX	U12_MM U23_MM U31_MM F_MM	I1 I2 I3 F	IN IPE IMS	I1_MAX I2_MAX I3_MAX	IN_MAX IPE_MAX IR21_MAX IR1 IR2 I0 UNB_IR2_IR1	P Q S PF	P1 P2 P3 P	Q1 Q2 Q3 Q	S1 S2 S3 S		P1_MAX P2_MAX P3_MAX P_MAX	Q1_MAX Q2_MAX Q3_MAX Q_MAX	S1_MAX S2_MAX S3_MAX S_MAX	P_TRIANGLE	P1_TRIANGLE	P2_TRIANGLE	P3_TRIANGLE	PF_MIN	Cφ_MIN			> 1.1 / 1.2	> 2.1 / 2.2			∅ 1.1 / 1.2	∅ 2.1 / 2.2		
U1N U2N U3N UNE	U12 U23 U31 F	U1N_MM U2N_MM U3N_MM UNE_MAX	U12_MM U23_MM U31_MM F_MM																														
I1 I2 I3 F	IN IPE IMS	I1_MAX I2_MAX I3_MAX	IN_MAX IPE_MAX IR21_MAX IR1 IR2 I0 UNB_IR2_IR1																														
P Q S PF	P1 P2 P3 P	Q1 Q2 Q3 Q	S1 S2 S3 S																														
	P1_MAX P2_MAX P3_MAX P_MAX	Q1_MAX Q2_MAX Q3_MAX Q_MAX	S1_MAX S2_MAX S3_MAX S_MAX																														
P_TRIANGLE	P1_TRIANGLE	P2_TRIANGLE	P3_TRIANGLE																														
PF_MIN	Cφ_MIN																																
> 1.1 / 1.2	> 2.1 / 2.2																																
∅ 1.1 / 1.2	∅ 2.1 / 2.2																																
<div style="border: 1px solid green; padding: 2px; display: inline-block;">  Energy </div> <div style="border: 1px solid green; padding: 2px; display: inline-block; margin-left: 20px;">Meter contents</div> <div style="border: 1px solid green; padding: 2px; display: inline-block; margin-left: 40px;">Standard meters</div>	<table border="1" style="width: 100%; border-collapse: collapse;"> <tr> <td>ΣP_I_IV_HT ΣP_I_IV_NT ΣP_II_III_NT ΣP_II_III_HT ΣQ_I_II_HT ΣQ_I_II_NT ΣQ_III_IV_HT ΣQ_I_II_NT</td> </tr> </table>	ΣP_I_IV_HT ΣP_I_IV_NT ΣP_II_III_NT ΣP_II_III_HT ΣQ_I_II_HT ΣQ_I_II_NT ΣQ_III_IV_HT ΣQ_I_II_NT																															
ΣP_I_IV_HT ΣP_I_IV_NT ΣP_II_III_NT ΣP_II_III_HT ΣQ_I_II_HT ΣQ_I_II_NT ΣQ_III_IV_HT ΣQ_I_II_NT																																	
<div style="border: 1px solid green; padding: 2px; display: inline-block;">  Energy </div> <div style="border: 1px solid green; padding: 2px; display: inline-block; margin-left: 20px;">Meter contents</div> <div style="border: 1px solid green; padding: 2px; display: inline-block; margin-left: 40px;">User meters</div>	<table border="1" style="width: 100%; border-collapse: collapse;"> <tr> <td>ΣMETER1 ΣMETER2 ΣMETER3 ΣMETER4 ΣMETER5 ΣMETER6 ΣMETER7 ΣMETER8 ΣMETER9 ΣMETER10 ΣMETER11 ΣMETER12</td> </tr> </table>	ΣMETER1 ΣMETER2 ΣMETER3 ΣMETER4 ΣMETER5 ΣMETER6 ΣMETER7 ΣMETER8 ΣMETER9 ΣMETER10 ΣMETER11 ΣMETER12																															
ΣMETER1 ΣMETER2 ΣMETER3 ΣMETER4 ΣMETER5 ΣMETER6 ΣMETER7 ΣMETER8 ΣMETER9 ΣMETER10 ΣMETER11 ΣMETER12																																	
<div style="border: 1px solid green; padding: 2px; display: inline-block;">  Energy </div> <div style="border: 1px solid green; padding: 2px; display: inline-block; margin-left: 20px;">Mean-values</div> <div style="border: 1px solid green; padding: 2px; display: inline-block; margin-left: 40px;">Power mean-values + trend</div>	<table border="1" style="width: 100%; border-collapse: collapse;"> <tr> <td>MT_P_I_IV</td> <td>MT_P_II_III</td> <td>MT_Q_I_II</td> <td>MT_Q_III_IV</td> <td>MT_S</td> </tr> </table>	MT_P_I_IV	MT_P_II_III	MT_Q_I_II	MT_Q_III_IV	MT_S																											
MT_P_I_IV	MT_P_II_III	MT_Q_I_II	MT_Q_III_IV	MT_S																													
<div style="border: 1px solid green; padding: 2px; display: inline-block;">  Energy </div> <div style="border: 1px solid green; padding: 2px; display: inline-block; margin-left: 20px;">Mean-values</div> <div style="border: 1px solid green; padding: 2px; display: inline-block; margin-left: 40px;">User mean-values + trend</div>	<table border="1" style="width: 100%; border-collapse: collapse;"> <tr> <td>M1 M2 M3 M4</td> <td>TR_M1 TR_M2 TR_M3 TR_M4</td> <td>M1_MM M2_MM M3_MM M4_MM</td> </tr> <tr> <td>M5 M6 M7 M8</td> <td>TR_M5 TR_M6 TR_M7 TR_M8</td> <td>M5_MM M6_MM M7_MM M8_MM</td> </tr> <tr> <td>M9 M10 M11 M12</td> <td>TR_M9 TR_M10 TR_M11 TR_M12</td> <td>M9_MM M10_MM M11_MM M12_MM</td> </tr> </table>	M1 M2 M3 M4	TR_M1 TR_M2 TR_M3 TR_M4	M1_MM M2_MM M3_MM M4_MM	M5 M6 M7 M8	TR_M5 TR_M6 TR_M7 TR_M8	M5_MM M6_MM M7_MM M8_MM	M9 M10 M11 M12	TR_M9 TR_M10 TR_M11 TR_M12	M9_MM M10_MM M11_MM M12_MM																							
M1 M2 M3 M4	TR_M1 TR_M2 TR_M3 TR_M4	M1_MM M2_MM M3_MM M4_MM																															
M5 M6 M7 M8	TR_M5 TR_M6 TR_M7 TR_M8	M5_MM M6_MM M7_MM M8_MM																															
M9 M10 M11 M12	TR_M9 TR_M10 TR_M11 TR_M12	M9_MM M10_MM M11_MM M12_MM																															
<div style="border: 1px solid green; padding: 2px; display: inline-block;">  Energy </div> <div style="border: 1px solid green; padding: 2px; display: inline-block; margin-left: 20px;">Bimetal current</div>	<table border="1" style="width: 100%; border-collapse: collapse;"> <tr> <td>IB1 IB2 IB3</td> <td>IB1_MAX IB2_MAX IB3_MAX</td> </tr> </table>	IB1 IB2 IB3	IB1_MAX IB2_MAX IB3_MAX																														
IB1 IB2 IB3	IB1_MAX IB2_MAX IB3_MAX																																

C Logic functions

The principal function of the logical gates is given in the following table, for simplicity shown for gates with two inputs only.

function	symbol	older symbols		truth table	plain text
		ANSI 91-1984	DIN 40700 (alt)		
AND				A B Y	Function is true if all input conditions are fulfilled
				0 0 0	
				0 1 0	
				1 0 0	
				1 1 1	
NAND				A B Y	Function is true if at least one of the input conditions is not fulfilled
				0 0 1	
				0 1 1	
				1 0 1	
				1 1 0	
OR				A B Y	Function is true if at least one of the input conditions is fulfilled
				0 0 0	
				0 1 1	
				1 0 1	
				1 1 1	
NOR				A B Y	Function is true if none of the input conditions is fulfilled
				0 0 1	
				0 1 0	
				1 0 0	
				1 1 0	

Using DIRECT or INVERT the input is directly connected to the output of a monitoring function, without need for a logical combination. For these functions only one input is used.

DIRECT		<table border="1"> <thead> <tr> <th>A</th> <th>Y</th> </tr> </thead> <tbody> <tr> <td>0</td> <td>0</td> </tr> <tr> <td>1</td> <td>1</td> </tr> </tbody> </table>	A	Y	0	0	1	1	The monitoring function is reduced to one input only. The state of the output corresponds to the input.
A	Y								
0	0								
1	1								
INVERT		<table border="1"> <thead> <tr> <th>A</th> <th>Y</th> </tr> </thead> <tbody> <tr> <td>0</td> <td>1</td> </tr> <tr> <td>1</td> <td>0</td> </tr> </tbody> </table>	A	Y	0	1	1	0	The monitoring function is reduced to one input only. The state of the output corresponds to the inverted input.
A	Y								
0	1								
1	0								

D FCC statement

The following statement applies to the products covered in this manual, unless otherwise specified herein. The statement for other products will appear in the accompanying documentation.

NOTE: This equipment has been tested and found to comply with the limits for a Class A digital device, pursuant to Part 15 of the FCC Rules and meets all requirements of the Canadian Interference-Causing Equipment Standard ICES-003 for digital apparatus. These limits are designed to provide reasonable protection against harmful interference in a residential installation. This equipment generates, uses, and can radiate radio frequency energy and, if not installed and used in accordance with the instructions, may cause harmful interference to radio communications. However, there is no guarantee that interference will not occur in a particular installation. If this equipment does cause harmful interference to radio or television reception, which can be determined by turning the equipment off and on, the user is encouraged to try to correct the interference by one or more of the following measures:

- Reorient or relocate the receiving antenna.
- Increase the separation between the equipment and receiver.
- Connect the equipment into an outlet on a circuit different from that to which the receiver is connected.
- Consult the dealer or an experienced radio/T.V. technician for help.

Camille Bauer AG is not responsible for any radio television interference caused by unauthorized modifications of this equipment or the substitution or attachment of connecting cables and equipment other than those specified by Camille Bauer AG. The correction of interference caused by such unauthorized modification, substitution or attachment will be the responsibility of the user.

INDEX

A

Alarming 61

C

Commissioning 32

Configuration
 menu 57

cosφ 85

D

Device overview 6

Display matrices 92

Disturbance recorder 70

Driving a counter mechanism 25

E

Electrical connections

 analog outputs 26

 Aron connection 20

 cross sections 11

 digital input 24

 digital output 25

 I/O extensions 11

 inputs 12

 Modbus interface 26

 Open-Y 22

 power supply 24

 relays 24

 split phase 23

Ethernet

 LEDs 39

Ethernet installation 35

F

Fault current 27

FCC statement 107

Firewall 37

G

GPS 30

H

HTTPS 51

I

I, II, III, IV 56

IEC61850 40

Installation check 33

L

Logic components

 AND 106

 DIRECT 106

 INVERT 106

 NAND 106

 NOR 106

 OR 106

Logic functions 106

M

Measured quantities 84

 Basic measurements 84

 Bimetal current 90

 earth fault monitoring 87

 harmonic analysis 88

 Load factors 86

 mean values and trend 90

 meters 91

 system imbalance 89

 zero displacement voltage 87

Measurement displays 55

Measurements

 reset 57

Mechanical mounting 9

Menu operation 54

N

NTP 37

O

Operating elements 54

P

PQDIF 73

Profinet IO 41

R

RCM 27

Reactive power 86

Resetting measurements 57

Roman numbers 56

S

Safety notes 6

Scope of supply 5

Security system 46

Service and maintenance 76

Simulation 45

Summary alarm 65

Symbols 56

Symmetrical components 89

SYSLOG 52

T

Technical data 77

temperature inputs 29

Time synchronization

 GPS 30

 NTP 37

U

UPS (Uninterruptible power supply) 29

W

Whitelist 51

Z

Zero suppression 78