

# PROFITEST MASTER Series

## PROFITEST MTECH+, MPRO, MXTRA, MBASE+

### IEC 60364-6, EN 50110-1

3-349-646-03  
33/2.23

- Testing of residual current devices (RCCBs)
- Measurement of touch voltage without tripping the RCCB  
Touch voltage is measured with reference to nominal residual current using  $\frac{1}{3}$  of the nominal residual current value.
- Testing for N-PE reversal
- Tripping test with nominal residual current, measurement of time to trip
- Testing of equipment and RCCBs with rising residual current including indication of tripping current and touch voltage
- Testing of RCCBs with the following nominal current values:  $\frac{1}{2} \times I_{\Delta N}$ ,  $1 \times I_{\Delta N}$ ,  $2 \times I_{\Delta N}$ , PROFITEST MPRO/PROFITEST MXTRA:  $5 \times I_{\Delta N}$  to 300 mA, PROFITEST MTECH+:  $5 \times I_{\Delta N}$  to 100 mA
- Intelligent ramp (PROFITEST MXTRA only): simultaneous measurement of breaking current  $I_{\Delta N}$  and breaking time  $t_A$
- Testing of selective **S** SRCDs, PRCDs (SCHUKOMAT, SIDOS or comparable), type G/R, type AC, types A and F, types B and B+ and type EV (except PROFITEST MPRO)
- Testing of RCCBs which are suitable for pulsating residual direct current – testing is conducted with positive or negative half-waves.
- Creation of test sequences (ETC)
- Intelligent data transmission  
Bidirectional interface to Graphisoft™ DDScad Elektro
- Simulation of operating states of electric vehicles at charging stations from different manufacturers (PROFITEST MTECH+ and PROFITEST MXTRA only)

## DESIGN PLUS

powered by: **light+building**



### Large Voltage and Frequency Ranges

A broad-range measuring device permits use of the test instrument in all alternating and 3-phase electrical systems with voltages from 65 to 500 V and frequencies of 16 to 400 Hz.

### Loop and Line Impedance Measurement

Measurement of loop and line impedance can be performed in the 65 to 500 V range. Conversion to short-circuit current is based on the respective nominal line voltage, insofar as the measured line voltage is within the specified range. Test instrument measuring error is also taken into account for conversion. Outside of this range, short-circuit current is calculated on the basis of momentary line voltage and measured impedance.

### Insulation Resistance Measurement

#### Using Nominal Voltage, with Variable or Rising Test Voltage

Insulation resistance is usually measured with a nominal voltage of 500, 250 or 100 V. A test voltage which deviates from nominal voltage, and lies within a range of 20/50 to 1000 V, can be selected for measurements at sensitive components, as well as systems with voltage limiting devices.

Measurement can be performed with a constantly rising test voltage in order to detect weak points in the insulation and determine tripping voltage for voltage limiting devices.

Voltage at the device under test and any triggering/breakdown voltage appear at the test instrument's display.

#### Standing-Surface Insulation Measurement

Standing-surface insulation measurement is performed with momentary line frequency and line voltage.

### Low-Resistance Measurement

Bonding conductor resistance and protective conductor resistance can be measured with a test current of  $\geq 200$  mA DC, automatic polarity reversal of the test voltage and selectable current flow direction. If the adjustable limit value is exceeded, an LED lights up.

### Earthing Resistance Measurement

In addition to measurement of the overall resistance of an earthing system, selective measurement of the earthing resistance of an individual earth electrode is also possible, without having to disconnect it from the earthing system. A current clamp sensor available as an accessory is utilized to this end.

Moreover, PROFITEST MPRO and PROFITEST MXTRA allow for battery-powered „battery operation“ earth resistance measurements:

3-/4-pole and earth loop resistance measurements.

### Universal Connector System

The interchangeable plug inserts and 2-pole plug-in adapter – which can be expanded to 3-poles for phase sequence testing – allows for use of the test instrument all over the world.

### Special Features

- Display of approved fuse types for electrical systems
- Energy meter start-up testing
- Measurement of biasing, leakage and circulating current of up to 1 A, as well as working current of up to 1000 A with current clamp sensor (available as an accessory)
- Phase sequence measurement (including highest line-to-line voltage)
- Option for connecting a Bluetooth® keyboard (Bluetooth® Classic 3.0)

# PROFITEST MASTER Series

## PROFITEST MTECH+, MPRO, MXTRA, MBASE+

### IEC 60364-6, EN 50110-1

#### Display with Selectable Language

Menus, setting options, measurement results, tables, notes and error messages as well as schematic diagrams appear at the LCD. The display can be set to the desired language depending on the country in which the test instrument is used: D, GB, I, F, E, P, NL, S, N, FIN, CZ or PL.

#### Operation

Device functions are selected directly with the help of a rotary selector knob. Softkeys allow for convenient selection of sub-functions and parameter settings. Unavailable functions and parameters are automatically prevented from appearing at the display.

The start and RCD tripping functions included directly on the instrument are identical to the functions of the two keys located on the test plug, allowing for easy measurement at difficult to access locations.

Schematic diagrams, measuring ranges and help texts can be displayed for all basic functions and sub-functions.

#### Phase Tester

Protective conductor potential is tested after starting a test sequence and touching the contact surface for finger contact. The PE symbol appears at the display if a potential difference of more than 25 V is detected between the contact surface and the protective contact at the mains plug.

#### Error Indication

- The instrument automatically detects instrument-to-system connection errors, which are indicated in a connection pictograph.
- Errors within the electrical system (no mains or phase voltage, tripped RCD) are indicated at 3 LEDs and in the tilting LCD panel.

#### Battery Monitoring and Self-test

Battery monitoring is conducted while the instrument is subjected to an electrical load. Results are displayed both numerically and with a symbol. Test images can be called up one after the other, and LEDs can be tested during the self-test. The tester is shut down automatically when the batteries are depleted. A microprocessor controlled charging circuit is used to assure safe charging of rechargeable batteries.

#### Interface for Bluetooth®

(PROFITEST MTECH+/PROFITEST MXTRA IQ only)

A Bluetooth® keyboard (Bluetooth® Classic 3.0) can be connected to the test instrument.

#### Data Entry at the RS-232 Port

Data can be read in via a barcode or RFID scanner connected to the RS-232 port, and comments can be entered with the help of the softkeys.

#### USB Interface

Test structures and test sequences are transferred from a PC to the test instrument via the integrated USB port. Measurement data are transmitted to a PC after testing, at which they can be printed in report form and archived.

#### PC Database and Report Generating Software – ETC

ETC test software offers lots of helpful options for data collection and management:

- Acquisition of all important data for reports in accordance with IEC 60364-6
- Test reports (ZVEH) can be generated automatically.

- Created structures can be saved to memory and loaded to the test instrument as required via the USB port.
- Distribution structures with electrical circuit and RCD data can be individually defined.
- Data export to Excel, CSV and XML formats
- Editing of device selection lists

#### Instrument Updates

The test instrument can always be kept current because the firm-ware/software can be updated via the USB port. Updating is executed during the course of recalibration by our service department, or directly by the customer.

## Display

(illustrative selection)

Softkeys allow for convenient selection of sub-functions and parameter settings. Unavailable sub-functions and parameters are automatically prevented from appearing at the display.

RCD Measurement Display

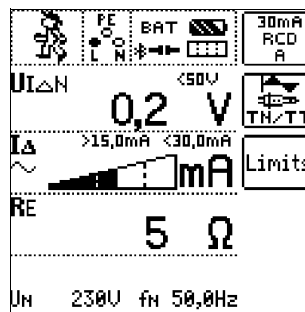

Loop Resistance Measurement Display

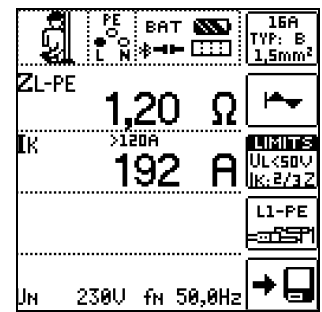

Earthing Resistance Measurement Display

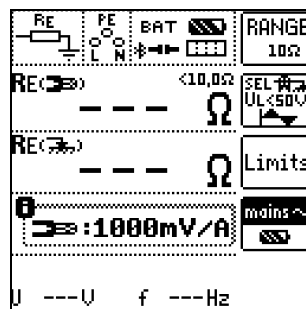

Low-Resistance Measurement Display

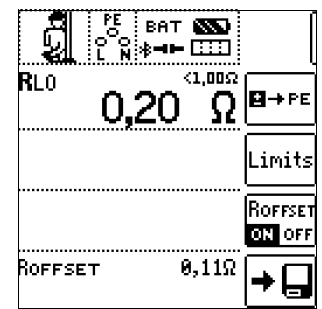

Insulation Measurement Display

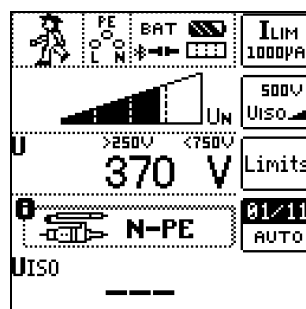

Voltage Measurement Display

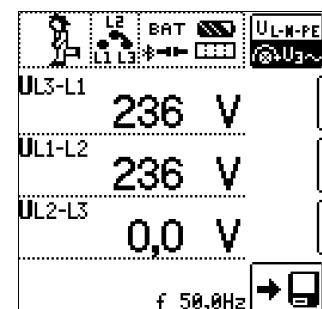

# PROFITEST MASTER Series

## PROFITEST MTECH+, MPRO, MXTRA, MBASE+

### IEC 60364-6, EN 50110-1

#### Features of Instrument Variants

PROFITEST ... (article number)	MBASE+ (M520S)	MPRO (M520N)	MTECH+ (M520R)	MXTRA (M520P)
<b>Testing of residual current devices (RCDs)</b>				
U <sub>B</sub> measurement without tripping the RCD	✓	✓	✓	✓
Tripping time measurement	✓	✓	✓	✓
Measurement of tripping current I <sub>F</sub>	✓	✓	✓	✓
Selective, SRCDs, PRCDs, type G/R	✓	✓	✓	✓
AC/DC sensitive RCDs, types B and B+	—	—	✓	✓
Testing of insulation monitoring devices (IMDs)	—	—	—	✓
Testing Residual Current Monitoring Devices (RCMs)	—	—	—	✓
Testing for N-PE reversal	✓	✓	✓	✓
<b>Measurement of loop impedance Z<sub>L-PE</sub> / Z<sub>L-N</sub></b>				
Fuse table for systems without RCDs	✓	✓	✓	✓
Without tripping the RCD, fuse table	—	—	✓	✓
15 mA measurement <sup>1)</sup>	✓	✓	✓	✓
<b>Earth resistance R<sub>E</sub> (mains operation)</b>				
I/U measuring method (2/3-wire measuring method via measuring adapter: 2-pole/2-pole + probe)	✓	✓	✓	✓
<b>Earthing resistance R<sub>E</sub> (battery operation)</b>				
3 or 4-wire measuring method via PRO-RE adapter	—	✓	—	✓
<b>Soil resistivity ρ<sub>E</sub> (battery operation)</b>				
(4-wire measuring method via PRO-RE adapter)	—	✓	—	✓
<b>Selective earth resistance R<sub>E</sub> (mains operation)</b>				
with 2-pole adapter, probe, earth electrode and current clamp sensor (3-wire measuring method)	✓	✓	✓	✓
<b>Selective earth resistance R<sub>E</sub> (battery operation)</b>				
with probe, earth electrode and current clamp sensor (4-wire measuring method via PRO-RE adapter and current clamp sensor)	—	✓	—	✓
<b>Earth loop resistance R<sub>ELOOP</sub> (battery operation)</b>				
with 2 clamps (current clamp sensor direct and current clamp transformer via PRO-RE/2 adapter)	—	✓	—	✓
<b>Measurement of equipotential bonding R<sub>LO</sub></b>				
Automatic polarity reversal	✓	✓	✓	✓
<b>Insulation resistance R<sub>INS</sub></b>				
Variable or rising test voltage (ramp)	✓	✓	✓	✓
<b>Voltage U<sub>L-N</sub> / U<sub>L-PE</sub> / U<sub>N-PE</sub> / f</b>				
✓	✓	✓	✓	✓
<b>Special Measurements</b>				
I <sub>L</sub> , I <sub>AMP</sub> current measurement with clamp	✓	✓	✓	✓
Phase sequence	✓	✓	✓	✓
Earth leakage resistance R <sub>E(INS)</sub>	✓	✓	✓	✓
Voltage drop (ΔU)	✓	✓	✓	✓
Standing-surface insulation Z <sub>ST</sub>	✓	✓	✓	✓
Meter start-up (kWh test)	✓	✓	✓	✓
Leakage current with PRO-AB (IL) adapter	—	—	—	✓
Residual voltage test (U <sub>res</sub> )	—	—	—	✓
Intelligent ramp (ta + ΔI)	—	—	—	✓
Electric vehicles at charging stations (IEC 61851-1)	—	—	✓	✓
Documentation of fault simulations at PRCDs with the PROFITEST PRCD adapter	—	—	—	✓
<b>Features</b>				
Selectable user interface language <sup>2)</sup>	✓	✓	✓	✓
Memory (database for up to 50,000 objects)	✓	✓	✓	✓
Automatic test sequence function	✓	✓	✓	✓
RS-232 port for RFID/barcode reader	✓	✓	✓	✓
USB port for data transmission	✓	✓	✓	✓
Interface for Bluetooth®	—	—	✓	✓
PC database and report generating software ETC	✓	✓	✓	✓
Measuring category: CAT III 600 V / CAT IV 300 V	✓	✓	✓	✓
DAkkS calibration certificate	✓	✓	✓	✓

<sup>1)</sup> The so-called live measurement is only advisable if there's no bias current within the system. Only suitable for motor protection switches with small nominal current values.

<sup>2)</sup> Currently available languages D, GB, I, F, E, P, NL, S, N, FIN, CZ, PL

#### Applicable Regulations and Standards

IEC 60364-6 EN 50110-1	Operation of electrical installations – Part 100: General requirements
EN 60529	Test instruments and test procedures Degrees of protection provided by enclosures (IP code)
IEC 60364-6	Low-voltage electrical installations – Part 6: Tests
IEC 60364-7-710	Low-voltage electrical installations – Requirements for special installations or locations – Part 710: Medical locations
IEC 61010/ EN 61010	Safety requirements for electrical equipment for measurement, control and laboratory use Part 1: General requirements (IEC 61010-1 + cor.) Part 31: Safety requirements for hand-held probe assemblies for electrical measurement and test (IEC 61010-031 + A1)
IEC 61140 DIN EN 61140	Protection against electric shock Common aspects for installations and equipment
DIN EN 61326-1	Electrical equipment for measurement, control and laboratory use – EMC requirements – Part 1: General requirements
IEC 61557/ EN 61557	Electrical safety in low voltage distribution systems up to 1000 V AC and 1500 V DC – Equipment for testing, measuring or monitoring of protective measures Part 1: General requirements (IEC 61557-1) Part 2: Insulation resistance (IEC 61557-2) Part 3: Loop resistance (IEC 61557-3) Part 4: Resistance of earth connection and equipotential bonding (IEC 61557-4) Part 5: Earthing resistance (IEC 61557-5) Part 6: Effectiveness of residual current devices (RCDs) in TT, TN and IT systems (IEC 61557-6) 6 Part 7: Phase sequence (IEC 61557-7) Part 10: Electrical safety in low voltage distribution systems up to 1000 V AC and 1500 V DC – Equipment for testing, measuring or monitoring of protective measures (IEC 61557-10) Part 11: Effectiveness of type A and type B residual current monitors (RCMs) in TT, TN and IT systems (IEC 61557-11) (PROFITEST MXTRA IQ only)
IEC 61851-1 DIN EN 61851-1	Electrical equipment for electric vehicles – Electric vehicle conductive charging systems – Part 1: General requirements

#### Nominal ranges of use

Voltage U <sub>N</sub>	120 V	(108 V ... 132 V)
	230 V	(196 V ... 253 V)
	400 V	(340 V ... 440 V)
Frequency f <sub>N</sub>	16 ⅔ Hz	(15.4 Hz ... 18 Hz)
	50 Hz	(49.5 Hz ... 50.5 Hz)
	60 Hz	(59.4 Hz ... 60.6 Hz)
	200 Hz	(190 Hz ... 210 Hz)
	400 Hz	(380 Hz ... 420 Hz)
Overall voltage range	65 V ... 550 V	
Overall frequency range	15.4 Hz ... 420 Hz	
Line voltage	Sinusoidal	
Temperature range	0 °C ... + 40 °C	
Battery voltage	8 V ... 12 V	
Line impedance angle	Corresponds to cosφ = 1 ... 0.95	
Probe resistance	< 50 kΩ	

# PROFITEST MASTER Series

## PROFITEST MTECH+, MPRO, MXTRA, MBASE+

### IEC 60364-6, EN 50110-1

#### Characteristic Values PROFITEST MTECH+ and PROFITEST MBASE+

Function	Measured Quantity	Display Range	Resolution	Input Impedance / Test Current	Measuring range	Nominal Values	Measuring Uncertainty	Intrinsic Uncertainty	Connections								
									Plug Insert	2-Pole Adapter	3-pole adapter	Probe	Clamp Meters WZ12C	Z3512A	MFLEX P300		
U	U <sub>L-PE</sub> U <sub>N-PE</sub>	0 V ... 99.9 V 100 V ... 600 V	0.1 V 1 V	5 MΩ	0.3 V ... 600 V <sup>1</sup>	U <sub>N</sub> = 120 V, 230 V, 400 V, 500 V  f <sub>N</sub> = 16.7 Hz, 50 Hz, 60 Hz, 200 Hz, 400 Hz	±(2% rdg.+5d) ±(2% rdg.+1d)	±(1% rdg.+5d) ±(1% rdg.+1d)	•	•	•						
	f	15.0 Hz ... 99.9 Hz 100 Hz ... 999 Hz	0.1 Hz 1 Hz		DC 15.4 Hz ... 420 Hz		±(0.2% rdg.+1d)	±(0.1% rdg.+1d)									
	U <sub>3 AC</sub>	0 V ... 99.9 V 100 V ... 600 V	0.1 V 1 V		0.3 V ... 600 V		±(3% rdg.+5d) ±(3% rdg.+1d)	±(2% rdg.+5d) ±(2% rdg.+1d)		•							
	U <sub>Probe</sub>	0 V ... 99.9 V 100 V ... 600 V	0.1 V 1 V		1.0 V ... 600 V		±(2% rdg.+5d) ±(2% rdg.+1d)	±(1% rdg.+5d) ±(1% rdg.+1d)			•						
	U <sub>L-N</sub>	0 V ... 99.9 V 100 V ... 600 V	0.1 V 1 V		1.0 V ... 600 V <sup>1</sup>		±(3% rdg.+5d) ±(3% rdg.+1d)	±(2% rdg.+5d) ±(2% rdg.+1d)	•		•						
I <sub>ΔN</sub> I <sub>F</sub>	U <sub>IΔN</sub>	0 V ... 70.0 V	0.1 V	0.3 × I <sub>ΔN</sub>	5 V ... 70 V	U <sub>N</sub> = 120 V, 230 V, 400 V <sup>2</sup>  f <sub>N</sub> = 50 Hz, 60 Hz  U <sub>L</sub> = 25 V, 50 V  I <sub>ΔN</sub> = 6 mA, 10 mA, 30 mA, 100 mA, 300 mA, 500 mA <sup>2</sup>	+110% rdg.+1d	+11% rdg.-1d ... +19% rdg.+1d									
	R <sub>E</sub>	10 Ω ... 999 Ω 1.00 kΩ ... 6.51 kΩ	1 Ω 0.01 kΩ	I <sub>ΔN</sub> = 10 mA × 1.05	Calculated value Off R <sub>E</sub> = U <sub>IΔN</sub> / I <sub>ΔN</sub>												
		3 Ω ... 999 Ω 1 kΩ ... 2.17 kΩ	1 Ω 0.01 kΩ	I <sub>ΔN</sub> = 30 mA × 1.05													
		1 Ω ... 651 Ω	1 Ω	I <sub>ΔN</sub> = 100 mA × 1.05													
		0.3 Ω ... 99.9 Ω 100 Ω ... 217 Ω	0.1 Ω 1 Ω	I <sub>ΔN</sub> = 300 mA × 1.05													
		0.2 Ω ... 9.9 Ω 10 Ω ... 130 Ω	0.1 Ω 1 Ω	I <sub>ΔN</sub> = 500 mA × 1.05													
	I <sub>F</sub> (I <sub>ΔN</sub> = 6 mA)	1.8 mA ... 7.8 mA	0.1 mA	1.8 mA ... 7.8 mA	1.8 mA ... 7.8 mA												
	I <sub>F</sub> (I <sub>ΔN</sub> = 10 mA)	3.0 mA ... 13.0 mA	0.1 mA	3.0 mA ... 13.0 mA	3.0 mA ... 13.0 mA												
	I <sub>F</sub> (I <sub>ΔN</sub> = 30 mA)	9.0 mA ... 39.0 mA	0.1 mA	9.0 mA ... 39.0 mA	9.0 mA ... 39.0 mA												
	I <sub>F</sub> (I <sub>ΔN</sub> = 100 mA)	30 mA ... 130 mA	1 mA	30 mA ... 130 mA	30 mA ... 130 mA												
	I <sub>F</sub> (I <sub>ΔN</sub> = 300 mA)	90 mA ... 390 mA	1 mA	90 mA ... 390 mA	90 mA ... 390 mA												
	I <sub>F</sub> (I <sub>ΔN</sub> = 500 mA)	150 mA ... 650 mA	1 mA	150 mA ... 650 mA	150 mA ... 650 mA												
	U <sub>IΔ</sub> / U <sub>L</sub> = 25 V	0 V ... 25.0 V	0.1 V	Same as I <sub>Δ</sub>	0 V ... 25.0 V												
U <sub>IΔ</sub> / U <sub>L</sub> = 50 V	0 V ... 50.0 V	0.1 V	Same as I <sub>Δ</sub>	0 V ... 50.0 V													
t <sub>A</sub> (I <sub>ΔN</sub> × 1)	0 ms ... 1000 ms	1 ms	6 mA ... 500 mA	0 ms ... 1000 ms													
t <sub>A</sub> (I <sub>ΔN</sub> × 2)	0 ms ... 1000 ms	1 ms	2 × 6 mA ... 2 × 500 mA	0 ms ... 1000 ms													
t <sub>A</sub> (I <sub>ΔN</sub> × 5)	0 ms ... 40 ms	1 ms	5 × 6 mA ... 5 × 300 mA	0 ms ... 40 ms													
Z <sub>L-PE</sub> Z <sub>L-N</sub>	Z <sub>L-PE</sub> Z <sub>L-N</sub>	0 mΩ ... 999 mΩ 1.00 Ω ... 9.99 Ω	1 mΩ 0.01 Ω	1.3 A AC ... 3.7 A AC 0.5 A DC, 1.25 A DC <sup>8</sup>	0.15 Ω ... 0.49 Ω 0.50 Ω ... 0.99 Ω 1.00 Ω ... 9.99 Ω	U <sub>N</sub> = 120 V, 230 V, 400 V, 500 V <sup>1</sup>  f <sub>N</sub> = 16.7 Hz, 50 Hz, 60 Hz	±(10% rdg.+30d) ±(10% rdg.+30d) ±(5% rdg.+3d)	±(5% rdg.+30d) ±(4% rdg.+30d) ±(3% rdg.+3d)									
	Z <sub>L-PE</sub> + DC <sup>8</sup>	0 mΩ ... 999 mΩ 1.00 Ω ... 9.99 Ω 10.0 Ω ... 29.9 Ω	0.1 Ω 0.1 Ω		0.25 Ω ... 0.99 Ω 1.00 Ω ... 9.99 Ω		U <sub>N</sub> = 120 V, 230 V f <sub>N</sub> = 50 Hz, 60 Hz	±(18% rdg.+30d) ±(10% rdg.+3d)	±(6% rdg.+50d) ±(4% rdg.+3d)								
	I <sub>k</sub> (Z <sub>L-PE</sub> )	0 to 9.9 A 10 A ... 999 A	0.1 A 1 A		120 (108 ... 132) V 230 (196 ... 253) V 400 (340 ... 440) V 500 (450 ... 550) V												
	Z <sub>L-PE</sub> + DC <sup>8</sup>	1.00 kA ... 9.99 kA 10.0 kA ... 50.0 kA	10 A 100 A		Value calculated from Z <sub>L-PE</sub>												
	Z <sub>L-PE</sub> (15 mA)	0.6 Ω ... 9.9 Ω 10.0 Ω ... 99.9 Ω 100 Ω ... 999 Ω	0.1 Ω 0.1 Ω 1 Ω		Display range only		10.0 Ω ... 99.9 Ω 100 Ω ... 999 Ω	U <sub>N</sub> = 120 V, 230 V f <sub>N</sub> = 16.7 Hz, 50 Hz, 60 Hz	±(10% rdg.+10d) ±(8% rdg.+2d)	±(2% rdg.+2d) ±(1% rdg.+1d)							
	I <sub>k</sub> (15 mA)	100 mA ... 999 mA 0.00 A ... 9.99 A 10.0 A ... 99.9 A	1 mA 0.01 A 0.1 A		15 mA AC		Calculated value depending on U <sub>N</sub> and Z <sub>L-PE</sub> : I <sub>k</sub> = U <sub>N</sub> / 10 Ω ... 1000 Ω			Value calculated from Z <sub>L-PE</sub> (15 mA): I <sub>k</sub> = U <sub>N</sub> / Z <sub>L-PE</sub> (15 mA)							
R <sub>E</sub>	R <sub>E</sub> (with probe)	0 mΩ ... 999 mΩ 1.00 Ω ... 9.99 Ω	1 mΩ 0.01 Ω	1.3 A AC ... 3.7 A AC 1.3 A AC ... 3.7 A AC	0.15 Ω ... 0.49 Ω 0.50 Ω ... 0.99 Ω 1.0 Ω ... 9.99 Ω	U <sub>N</sub> = 120 V, 230 V U <sub>N</sub> = 400 V <sup>1</sup> f <sub>N</sub> = 50 Hz, 60 Hz	±(10% rdg.+30d) ±(10% rdg.+30d) ±(5% rdg.+3d)	±(5% rdg.+30d) ±(4% rdg.+30d) ±(3% rdg.+3d)									
	[R <sub>E</sub> (without probe) values same as Z <sub>L-PE</sub> ]	10.0 Ω ... 99.9 Ω 100 Ω ... 999 Ω 1 kΩ ... 9.99 kΩ	0.1 Ω 1 Ω 0.01 kΩ	400 mA AC 40 mA AC 4 mA AC	1.0 Ω ... 9.99 Ω 10 Ω ... 99.9 Ω 100 Ω ... 999 Ω 1 kΩ ... 9.99 kΩ												
	R <sub>E</sub> DC+ <sup>8</sup>	0 mΩ ... 999 mΩ 1.00 Ω ... 9.99 Ω 10.0 Ω ... 29.9 Ω	1 mΩ 0.01 Ω 0.1 Ω	1.3 A AC ... 3.7 A AC 0.5 A DC, 1.25 A DC <sup>8</sup>	0.25 Ω ... 0.99 Ω 1.00 Ω ... 9.99 Ω		U <sub>N</sub> = 120 V, 230 V f <sub>N</sub> = 50 Hz, 60 Hz	±(18% rdg.+30d) ±(10% rdg.+3d)	±(6% rdg.+50d) ±(4% rdg.+3d)								
	U <sub>E</sub>	0 V ... 253 V	1 V	—	Calculated value												
R <sub>E</sub> Sel Clamp	R <sub>E</sub>	0 Ω ... 999 Ω	1 mΩ ... 1 Ω	1.3 A AC ... 2.7 A AC 0.5 A DC / 1.25 A DC <sup>8</sup>	0.25 Ω ... 300 Ω <sup>4</sup>	See R <sub>E</sub>	±(20% rdg.+20 d)	±(15% rdg.+20 d)					•				
	R <sub>E</sub> DC+ <sup>8</sup>	0 Ω ... 999 Ω	1 mΩ ... 1 Ω			U <sub>N</sub> = 120 V, 230 V f <sub>N</sub> = 50 Hz, 60 Hz	±(22% rdg.+20 d)	±(15% rdg.+20 d)						•			
EXTRA	Z <sub>ST</sub>	10 kΩ ... 199 kΩ 200 kΩ ... 999 kΩ 1.00 MΩ ... 9.99 MΩ 10.0 MΩ ... 30.0 MΩ	1 kΩ 1 kΩ 0.01 MΩ 0.1 MΩ	2.3 mA at 230 V	10 kΩ ... 199 kΩ 200 kΩ ... 999 kΩ 1.00 MΩ ... 9.99 MΩ 10.0 MΩ ... 30.0 MΩ	U <sub>0</sub> = U <sub>L-N</sub>	±(20% rdg.+2d)	±(10% rdg.+3d)	•	•	•						

# PROFITEST MASTER Series

## PROFITEST MTECH+, MPRO, MXTRA, MBASE+

### IEC 60364-6, EN 50110-1

#### Characteristic Values PROFITEST MTECH+ and PROFITEST MBASE+

Function	Measured Quantity	Display Range	Resolution	Test Current	Measuring range	Nominal Values	Measuring Uncertainty	Intrinsic Uncertainty	Connections					
									Plug Insert <sup>1</sup>	2-Pole Adapter	3-pole adapter	Clamps / Meas. Ranges WZ12 C Z3512 A MFLEX P300	CP1100	
R <sub>ISO</sub>	R <sub>INS</sub> , R <sub>E INS</sub>	1 kΩ ... 999 kΩ 1.00 MΩ ... 9.99 MΩ 10.0 MΩ ... 49.9 MΩ	1 kΩ 10 kΩ 100 kΩ	I <sub>k</sub> = 1.5 mA	50 kΩ ... 999 kΩ 1.00 MΩ ... 49.9 MΩ	U <sub>N</sub> = 50 V I <sub>N</sub> = 1 mA	kΩ range ±(15% rdg.l.+10d)	kΩ range ±(13% rdg.l.+10d)	•	•				
		1 kΩ ... 999 kΩ 1.00 MΩ ... 9.99 MΩ 10.0 MΩ ... 99.9 MΩ	1 kΩ 10 kΩ 100 kΩ		50 kΩ ... 999 kΩ 1.00 MΩ ... 99.9 MΩ	U <sub>N</sub> = 100 V I <sub>N</sub> = 1 mA								
		1 kΩ ... 999 kΩ 1.00 MΩ ... 9.99 MΩ 10.0 MΩ ... 99.9 MΩ 100 MΩ ... 200 MΩ	1 kΩ 10 kΩ 100 kΩ 1 MΩ		50 kΩ ... 999 kΩ 1.00 MΩ ... 200 MΩ	U <sub>N</sub> = 250 V I <sub>N</sub> = 1 mA								
		1 kΩ ... 999 kΩ 1.00 MΩ ... 9.99 MΩ 10.0 MΩ ... 99.9 MΩ 100 MΩ ... 500 MΩ	1 kΩ 10 kΩ 100 kΩ 1 MΩ		50 kΩ ... 999 kΩ 1.00 MΩ ... 499 MΩ	U <sub>N</sub> = 325 V, U <sub>N</sub> = 500 V, U <sub>N</sub> = 1000 V I <sub>N</sub> = 1 mA								
U		10 V ... 999 V 1.00 kV ... 1.19 kV	1 V 10 V		10 kV ... 1.19 kV		±(3% rdg.l.+1d)	±(1.5% rdg.l.+1d)						
R <sub>LO</sub>	R <sub>LO</sub>	0.00 Ω ... 9.99 Ω 10.0 Ω ... 99.9 Ω 100 Ω ... 199 Ω	0.01 Ω 0.1 Ω 1 Ω	I ≥ 200 mA DC I < 260 mA DC	0.10 Ω ... 5.99 Ω 6.00 Ω ... 99.9 Ω	U <sub>0</sub> = 4.5 V	±(4% rdg.l.+2d)	±(2% rdg.l.+2d)		•				
	R <sub>OFFSET</sub>	0.00 Ω ... 9.99 Ω	0.01 Ω	I ≥ 200 mA DC I < 260 mA DC	0.10 Ω ... 5.99 Ω 6.00 Ω ... 99.9 Ω									
				Transformation ratio <sup>3</sup>			5	5						
SENSOR 6, 7	I <sub>L/Amp</sub>	0.0 mA ... 99.9 mA 100 mA ... 999 mA	0.1 mA 1 mA	1 V/A	5 A ... 15 A	f <sub>N</sub> = 50 Hz, 60 Hz	±(13% rdg.l.+5d)	±(15% rdg.l.+4d)				I 15A		
		1.00 A ... 9.99 A 10.0 A ... 15.0 A	0.01 A 0.1 A				±(13% rdg.l.+1d)	±(5% rdg.l.+1d)						
		1.00 A ... 9.99 A 10.0 A ... 99.9 A 100 A ... 150 A	0.01 A 0.1 A 1 A				0.1 mV/A 5 A ... 150 A	±(11% rdg.l.+4d)	±(4% rdg.l.+3d)			II 150 A		
		0.0 mA ... 99.9 mA 100 mA ... 999 mA	0.1 mA 1 mA				1 V/A 5 mA ... 1000 mA	±(17% rdg.l.+2d)	±(5% rdg.l.+2d)				1 A 10 A 100 A 1000 A	
		0.00 A ... 9.99 A 0.00 A ... 9.99 A 10.0 A ... 99.9 A	0.01 A 0.01 A 0.1 A	100 mV/A 0.05 A ... 10 A	±(7% rdg.l.+1d)	±(5% rdg.l.+1d)								
		0.00 A ... 9.99 A 10.0 A ... 99.9 A 100 A ... 999 A	0.01 A 0.01 A 0.1 A	10 mV/A 0.5 A ... 100 A	±(3.4% rdg.l.+2d)	±(3% rdg.l.+2d)								
		0.00 A ... 9.99 A 10.0 A ... 99.9 A 100 A ... 999 A	0.01 A 0.1 A 1 A	0.1 mV/A 5 A ... 1000 A	±(3.1% rdg.l.+2d)	±(3% rdg.l.+2d)								
		0.00 A ... 99.9 mA 100 mA ... 999 mA	0.1 mA 1 mA	1 V/A 30 mA ... 1000 mA	±(17% rdg.l.+10d)	±(3% rdg.l.+10d)			3 A 30 A 300 A					
		0.00 A ... 9.99 A 0.00 A ... 9.99 A 10.0 A ... 99.9 A	0.01 A 0.01 A 0.1 A	100 mV/A 0.3 A ... 10 A	±(27% rdg.l.+11d)	±(3% rdg.l.+11d)								
		0.00 A ... 9.99 A 10.0 A ... 99.9 A 100 A ... 999 A	0.01 A 0.1 A 1 A	10 mV/A 3 A ... 100 A	±(27% rdg.l.+12d)	±(3% rdg.l.+12d)								
		0.00 A ... 9.99 A 10.0 A ... 99.9 A 100 A ... 999 A	0.01 A 0.1 A 1 A	10 mV/A 0.5 A ... 100 A	±(27% rdg.l.+11d)	±(3% rdg.l.+11d)								
		0.00 A ... 9.99 A 10.0 A ... 99.9 A 100 A ... 999 A	0.01 A 0.1 A 1 A	10 mV/A 5 A ... 1000 A	±(15% rdg.l.+12d)	±(3% rdg.l.+12d)			100 A 1000 A					
		0.00 A ... 9.99 A 10.0 A ... 99.9 A 100 A ... 999 A	0.01 A 0.1 A 1 A	0.1 mV/A 5 A ... 1000 A	±(15% rdg.l.+2d)	±(3% rdg.l.+2d)								
		0.00 A ... 9.99 A 10.0 A ... 99.9 A 100 A ... 999 A	0.01 A 0.1 A 1 A	0.1 mV/A 5 A ... 1000 A	±(15% rdg.l.+50d)	±(3% rdg.l.+50d)								
		0.00 A ... 9.99 A 10.0 A ... 99.9 A 100 A ... 999 A	0.01 A 0.1 A 1 A	0.1 mV/A 5 A ... 1000 A	±(15% rdg.l.+7d)	±(3% rdg.l.+7d)								

<sup>1</sup> U > 230 V with 2 or 3-pole adapter only  
<sup>2</sup> 1 × I<sub>ΔN</sub> > 300 mA and 2 × I<sub>ΔN</sub> > 300 mA and 5 × I<sub>ΔN</sub> > 500 mA and I<sub>f</sub> > 300 mA up to U<sub>N</sub> ≤ 230 V only!  
 5 × I<sub>ΔN</sub> > 300 mA with U<sub>N</sub> = 230 V only  
<sup>3</sup> The transformation ratio selected at the clamp (1/10/100/1000 mV/A) must be set in the "Type" menu with the rotary switch in the "SENSOR" position.  
<sup>4</sup> Where R<sub>Eselective</sub>/R<sub>Etotal</sub> < 100  
<sup>5</sup> The specified measuring and intrinsic uncertainties already include those of the respective current clamp..  
<sup>6</sup> Measuring range of the signal input at the test instrument, U<sub>E</sub>: 0 ... 1.0 V<sub>TRMS</sub> (0 ... 1.4 V<sub>peak</sub>) AC/DC  
<sup>7</sup> Input impedance of the signal input at the test instrument: 800 kΩ  
<sup>8</sup> DC bias only possible with PROFITEST MTECH+





**Key:** d = digit(s), rdg. = reading (measured value)

# PROFITEST MASTER Series

## PROFITEST MTECH+, MPRO, MXTRA, MBASE+

### IEC 60364-6, EN 50110-1

#### Characteristic Values PROFITEST MXTRA and PROFITEST MPRO

Function	Measured Quantity	Display Range	Resolution	Input Impedance / Test Current	Measuring range	Nominal Values	Measuring Uncertainty	Intrinsic Uncertainty	Connections							
									Plug Insert <sup>1</sup>	2-Pole Adapter	3-pole adapter	Probe	Clamp Meters			
										WZ12C	Z3512A	MFLEX P300				
U	U <sub>L-PE</sub> U <sub>N-PE</sub>	0 V ... 99.9 V 100 V ... 600 V	0.1 V 1 V	5 MΩ	0.3 V ... 600 V <sup>1</sup>	U <sub>N</sub> = 120 V, 230 V, 400 V, 500 V,  f <sub>N</sub> = 16.7 Hz, 50 Hz, 60 Hz, 200 Hz, 400 Hz	±(2% rdg.+5d) ±(2% rdg.+1d)	±(1% rdg.+5d) ±(1% rdg.+1d)	•	•	•					
	f	15.0 Hz ... 99.9 Hz 100 Hz ... 999 Hz	0.1 Hz 1 Hz		DC 15.4 Hz ... 420 Hz		±(0.2% rdg.+1d)	±(0.1% rdg.+1d)								
	U <sub>3 AC</sub>	0 V ... 99.9 V 100 V ... 600 V	0.1 V 1 V		0.3 V ... 600 V		±(3% rdg.+5d) ±(3% rdg.+1d)	±(2% rdg.+5d) ±(2% rdg.+1d)								
	U <sub>Probe</sub>	0 V ... 99.9 V 100 V ... 600 V	0.1 V 1 V		1.0 V ... 600 V		±(2% rdg.+5d) ±(2% rdg.+1d)	±(1% rdg.+5d) ±(1% rdg.+1d)								
	U <sub>L-N</sub>	0 V ... 99.9 V 100 V ... 600 V	0.1 V 1 V		1.0 V ... 600 V <sup>1</sup>		±(3% rdg.+5d) ±(3% rdg.+1d)	±(2% rdg.+5d) ±(2% rdg.+1d)	•							
I <sub>ΔN</sub>	U <sub>IΔN</sub>	0 V ... 70.0 V	0.1 V	0.3 × I <sub>ΔN</sub>	5 V ... 70 V	U <sub>N</sub> = 120 V, 230 V, 400 V <sup>2</sup>  f <sub>N</sub> = 50 Hz, 60 Hz  U <sub>L</sub> = 25 V, 50 V  I <sub>ΔN</sub> = 6 mA, 10 mA, 30 mA, 100 mA, 300 mA, 500 mA <sup>2</sup>	+10% rdg.+1d	+11% rdg.-1d ... +19% rdg.+1d								
	R <sub>E</sub>	10 Ω ... 999 Ω 1.00 kΩ ... 6.51 kΩ	1 Ω 0.01 kΩ	I <sub>ΔN</sub> = 10 mA × 1.05	Calculated value Off R <sub>E</sub> = U <sub>IΔN</sub> / I <sub>ΔN</sub>		U <sub>N</sub> = 120 V, 230 V, 400 V <sup>2</sup>  f <sub>N</sub> = 50 Hz, 60 Hz  U <sub>L</sub> = 25 V, 50 V  I <sub>ΔN</sub> = 6 mA, 10 mA, 30 mA, 100 mA, 300 mA, 500 mA <sup>2</sup>	±(5% rdg.+1d)	±(3.5% rdg.+2d)	•	•	•	optionally			
		3 Ω ... 999 Ω 1 kΩ ... 2.17 kΩ	1 Ω 0.01 kΩ	I <sub>ΔN</sub> = 30 mA × 1.05												
		1 Ω ... 651 Ω 0.3 Ω ... 99.9 Ω	1 Ω 0.1 Ω	I <sub>ΔN</sub> = 100 mA × 1.05												
		100 Ω ... 217 Ω 10 Ω ... 130 Ω	1 Ω 0.1 Ω	I <sub>ΔN</sub> = 300 mA × 1.05												
		0.2 Ω ... 9.9 Ω 10 Ω ... 130 Ω	0.1 Ω 1 Ω	I <sub>ΔN</sub> = 500 mA × 1.05												
	I <sub>F</sub> (I <sub>ΔN</sub> = 6 mA)	1.8 mA ... 7.8 mA	0.1 mA	1.8 mA ... 7.8 mA	1.8 mA ... 7.8 mA											
	I <sub>F</sub> (I <sub>ΔN</sub> = 10 mA)	3.0 mA ... 13.0 mA	0.1 mA	3.0 mA ... 13.0 mA	3.0 mA ... 13.0 mA											
	I <sub>F</sub> (I <sub>ΔN</sub> = 30 mA)	9.0 mA ... 39.0 mA	0.1 mA	9.0 mA ... 39.0 mA	9.0 mA ... 39.0 mA											
	I <sub>F</sub> (I <sub>ΔN</sub> = 100 mA)	30 mA ... 130 mA	1 mA	30 mA ... 130 mA	30 mA ... 130 mA											
I <sub>F</sub> (I <sub>ΔN</sub> = 300 mA)	90 mA ... 390 mA	1 mA	90 mA ... 390 mA	90 mA ... 390 mA												
I <sub>F</sub> (I <sub>ΔN</sub> = 500 mA)	150 mA ... 650 mA	1 mA	150 mA ... 650 mA	150 mA ... 650 mA												
U <sub>IΔ</sub> / U <sub>L</sub> = 25 V	0 V ... 25.0 V	0.1 V	Same as I <sub>Δ</sub>	0 V ... 25.0 V			+10% rdg.+1d	+11% rdg.-1d ... +19% rdg.+1d								
U <sub>IΔ</sub> / U <sub>L</sub> = 50 V	0 V ... 50.0 V			0 V ... 50.0 V												
t <sub>A</sub> (I <sub>ΔN</sub> × 1)	0 ms ... 1000 ms	1 ms	6 mA ... 500 mA	0 ms ... 1000 ms												
t <sub>A</sub> (I <sub>ΔN</sub> × 2)	0 ms ... 1000 ms	1 ms	2 × 6 mA ... 2 × 500 mA	0 ms ... 1000 ms												
t <sub>A</sub> (I <sub>ΔN</sub> × 5)	0 ms ... 40 ms	1 ms	5 × 6 mA ... 5 × 300 mA	0 ms ... 40 ms												
Z <sub>L-PE</sub> Z <sub>L-N</sub>	Z <sub>L-PE</sub> (  ) Z <sub>L-N</sub>	0 mΩ ... 999 mΩ 1.00 Ω ... 9.99 Ω	1 mΩ 0.01 Ω 0.1 Ω	3.7 A AC ... 4.7 A AC	0.10 Ω ... 0.49 Ω 0.50 Ω ... 0.99 Ω 1.00 Ω ... 9.99 Ω	U <sub>N</sub> = 120 V, 230 V, 400 V, 500 V <sup>1</sup> f <sub>N</sub> = 16.7 Hz, 50 Hz, 60 Hz	±(10% rdg.+20d) ±(10% rdg.+20d) ±(5% rdg.+3d)	±(5% rdg.+20d) ±(4% rdg.+20d) ±(3% rdg.+3d)								
	Z <sub>L-PE</sub>  + DC <sup>8</sup>	0 mΩ ... 999 mΩ 1.00 Ω ... 9.99 Ω 10.0 Ω ... 29.9 Ω		3.7 A AC ... 4.7 A AC 0.5 A DC, 1.25 A DC <sup>8</sup>	0.25 Ω ... 0.99 Ω 1.00 Ω ... 9.99 Ω	U <sub>N</sub> = 120 V, 230 V f <sub>N</sub> = 50 Hz, 60 Hz	±(18% rdg.+30d) ±(10% rdg.+3d)	±(6% rdg.+50d) ±(4% rdg.+3d)								
	I <sub>K</sub> (Z <sub>L-PE</sub>  + DC <sup>8</sup> )	0 to 9.9 A 10 A ... 999 A 1.00 kA ... 9.99 kA 10.0 kA ... 50.0 kA	0.1 A 1 A 10 A 100 A		120 (108 ... 132) V 230 (196 ... 253) V 400 (340 ... 440) V 500 (450 ... 550) V		Value calculated from Z <sub>L-PE</sub>									
	Z <sub>L-PE</sub> (15 mA)	0.6 Ω ... 99.9 Ω 100 Ω ... 999 Ω	0.1 Ω 1 Ω		10.0 Ω ... 99.9 Ω 100 Ω ... 999 Ω	U <sub>N</sub> = 120 V, 230 V f <sub>N</sub> = 16.7, 50 Hz, 60 Hz	±(10% rdg.+10d) ±(8% rdg.+2d)	±(2% rdg.+2d) ±(1% rdg.+1d)								
	I <sub>K</sub> (15 mA)	0.10 A ... 9.99 A 10.0 A ... 99.9 A 100 A ... 999 A <sup>11</sup>	0.01 A 0.1 A 1 A	15 mA AC	100 mA ... 12 A (U <sub>N</sub> = 120 V) 200 mA ... 25 A (U <sub>N</sub> = 230 V)		Value calculated from I <sub>K</sub> = U <sub>N</sub> / Z <sub>L-PE</sub> (15 mA)									
R <sub>E</sub>	R <sub>E,sel</sub> (without probe)	0 mΩ ... 999 mΩ 1.00 Ω ... 9.99 Ω 10.0 Ω ... 99.9 Ω	1 mΩ 0.01 Ω 0.1 Ω	3.7 A AC ... 4.7 A AC 3.7 A AC ... 4.7 A AC 400 mA AC	0.10 Ω ... 0.49 Ω 0.50 Ω ... 0.99 Ω 1.0 Ω ... 9.99 Ω 10 Ω ... 99.9 Ω 100 Ω ... 999 Ω 1 kΩ ... 9.99 kΩ	U <sub>N</sub> same as function U <sup>1</sup> f <sub>N</sub> = 50 Hz, 60 Hz	±(10% rdg.+20d) ±(10% rdg.+20d) ±(5% rdg.+3d) ±(10% rdg.+3d) ±(10% rdg.+3d) ±(10% rdg.+3d)	±(5% rdg.+20d) ±(4% rdg.+20d) ±(3% rdg.+3d) ±(3% rdg.+3d) ±(3% rdg.+3d) ±(3% rdg.+3d)								
	R <sub>E</sub> (with probe)	100 Ω ... 999 Ω 1 kΩ ... 9.99 kΩ	1 Ω 0.01 kΩ	40 mA AC 4 mA AC	100 Ω ... 999 Ω 1 kΩ ... 9.99 kΩ											
	R <sub>E</sub> (15 mA)	0.5 Ω ... 99.9 Ω 100 Ω ... 999 Ω	0.1 Ω 1 Ω	15 mA AC	10 Ω ... 99.9 Ω 100 Ω ... 999 Ω	U <sub>N</sub> = 120 V, 230 V f <sub>N</sub> = 50 Hz, 60 Hz	±(10% rdg.+10d) ±(8% rdg.+2d)	±(2% rdg.+2d) ±(1% rdg.+1d)								
	R <sub>E,PE</sub> (without probe)	0 mΩ ... 999 mΩ 1.00 Ω ... 9.99 Ω 10.0 Ω ... 29.9 Ω	1 mΩ 0.01 Ω 0.1 Ω	3.7 A AC ... 4.7 A AC 0.5 A DC, 1.25 A DC <sup>8</sup>	0.25 Ω ... 0.99 Ω 1.00 Ω ... 9.99 Ω	U <sub>N</sub> = 120 V, 230 V f <sub>N</sub> = 50 Hz, 60 Hz	±(18% rdg.+30d) ±(10% rdg.+3d)	±(6% rdg.+50d) ±(4% rdg.+3d)								
	R <sub>E,PE</sub> (without probe) + DC <sup>8</sup>	0 mΩ ... 999 mΩ 1.00 Ω ... 9.99 Ω 10.0 Ω ... 29.9 Ω	1 mΩ 0.01 Ω 0.1 Ω				Calculated U <sub>E</sub> = U <sub>N</sub> × R <sub>E</sub> / R <sub>E,PE</sub>									
R <sub>E Sel</sub> Clamp	R <sub>E,sel</sub> (only with probe)	0 mΩ ... 999 mΩ 1.00 Ω ... 9.99 Ω 10.0 Ω ... 99.9 Ω 100 Ω ... 999 Ω	1 mΩ 0.01 Ω 0.1 Ω 1 Ω	2.1 A AC 2.1 A AC 400 mA AC 40 mA AC	0.25 Ω ... 300 Ω <sup>4</sup>	U <sub>N</sub> = 120 V, 230 V f <sub>N</sub> = 50 Hz, 60 Hz	±(20% rdg.+20 d)	±(15% rdg.+20 d)								
	R <sub>E,sel</sub>  + DC <sup>8</sup> (only with probe)	0 mΩ ... 999 mΩ 1.00 Ω ... 9.99 Ω 10.0 Ω ... 99.9 Ω 100 Ω ... 999 Ω	1 mΩ 0.01 Ω 0.1 Ω 1 Ω	3.7 A AC ... 4.7 A AC 0.5 A DC, 1.25 A DC <sup>8</sup>	0.25 Ω ... 300 Ω R <sub>E,tot</sub> < 10 Ω <sup>4</sup>	U <sub>N</sub> = 120 V, 230 V f <sub>N</sub> = 50 Hz, 60 Hz	±(22% rdg.+20 d)	±(15% rdg.+20 d)								
EXTRA	Z <sub>ST</sub>	10 kΩ ... 199 kΩ 200 kΩ ... 999 kΩ 1.00 MΩ ... 9.99 MΩ 10.0 MΩ ... 30.0 MΩ	1 kΩ 1 kΩ 0.01 MΩ 0.1 MΩ	2.3 mA at 230 V	10 kΩ ... 199 kΩ 200 kΩ ... 999 kΩ 1.00 MΩ ... 9.99 MΩ 10.0 MΩ ... 30.0 MΩ	U <sub>0</sub> = U <sub>L-N</sub>	±(20% rdg.+2d) ±(10% rdg.+3d)	±(10% rdg.+3d) ±(5% rdg.+3d)	•	•	•	•				

# PROFITEST MASTER Series

## PROFITEST MTECH+, MPRO, MXTRA, MBASE+

### IEC 60364-6, EN 50110-1

**Characteristic Values PROFITEST MXTRA and PROFITEST MPRO**

Function	Measured Quantity	Display Range	Resolution	Test Current	Measuring range	Nominal Values	Measuring Uncertainty	Intrinsic Uncertainty	Connections								
									Plug Insert <sup>1</sup>	2-Pole Adapter	3-pole adapter	Clamps / Meas. Ranges WZ12C Z3512A MFLEX P300 CP1100					
EXTRA	IMD Test	20 kΩ ... 648 kΩ 2.51 MΩ	1 kΩ 0.01 MΩ	IT line voltage U <sub>N</sub> = 90 ... 550 V	20 kΩ ... 199 kΩ 200 kΩ ... 648 kΩ 2.51 MΩ	IT system nominal voltages U <sub>N</sub> = 120 V, 230 V, 400 V, 500 V f <sub>N</sub> = 50 Hz, 60 Hz	± 7% ± 12% ± 3%	± 5% ± 10% ± 2%	•		•						
R <sub>ISO</sub>	R <sub>INS</sub> , R <sub>EINS</sub>	1 kΩ ... 999 kΩ 1.00 MΩ ... 9.99 MΩ 10.0 MΩ ... 49.9 MΩ	1 kΩ 10 kΩ 100 kΩ	I <sub>K</sub> = 1.5 mA	50 kΩ ... 999 kΩ 1.00 MΩ ... 49.9 MΩ	U <sub>N</sub> = 50 V I <sub>N</sub> = 1 mA	kΩ range ±(15% rdg.l+10d)	kΩ range ±(13% rdg.l+10d)	•	•							
		1 kΩ ... 999 kΩ 1.00 MΩ ... 9.99 MΩ 10.0 MΩ ... 99.9 MΩ	1 kΩ 10 kΩ 100 kΩ		50 kΩ ... 999 kΩ 1.00 MΩ ... 99.9 MΩ	U <sub>N</sub> = 100 V I <sub>N</sub> = 1 mA										MΩ range ±(15% rdg.l+1d)	MΩ range ±(13% rdg.l+1d)
		1 kΩ ... 999 kΩ 1.00 MΩ ... 9.99 MΩ 10.0 MΩ ... 99.9 MΩ 100 MΩ ... 200 MΩ	1 kΩ 10 kΩ 100 kΩ 1 MΩ		50 kΩ ... 999 kΩ 1.00 MΩ ... 200 MΩ	U <sub>N</sub> = 250 V I <sub>N</sub> = 1 mA											
		1 ... 999 kΩ 1.00 ... 9.99 MΩ 10.0 ... 99.9 MΩ 100 ... 500 MΩ	1 kΩ 10 kΩ 100 kΩ 1 MΩ		50 kΩ ... 999 kΩ 1.00 MΩ ... 499 MΩ	U <sub>N</sub> = 325 V U <sub>N</sub> = 500 V U <sub>N</sub> = 1000 V I <sub>N</sub> = 1 mA											
U	10 V ... 999 V DC 1.00 kV ... 1.19 kV	1 V 10 V		10 kV ... 1.19 kV		±(13% rdg.l+1d)	±(11.5% rdg.l+1d)										
R <sub>LO</sub>	R <sub>LO</sub>	0.00 Ω ... 9.99 Ω 10.0 Ω ... 99.9 Ω 100 Ω ... 199 Ω	0.01 Ω 0.1 Ω 1 Ω	I ≥ 200 mA DC I < 260 mA DC	0.10 Ω ... 5.99 Ω 6.00 Ω ... 99.9 Ω	U <sub>0</sub> = 4.5 V	±(14% rdg.l+2d)	±(12% rdg.l+2d)		•							
	R <sub>OFFSET</sub>	0.00 Ω ... 9.99 Ω	0.01 Ω	I ≥ 200 mA DC I < 260 mA DC	0.10 Ω ... 5.99 Ω 6.00 Ω ... 99.9 Ω												
				Transformation ratio <sup>3</sup>			5	5									
SENSOR 6, 7	I <sub>L/Amp</sub>	0.0 mA ... 99.9 mA	0.1 mA	1 V/A	5 A ... 15 A	f <sub>N</sub> = 50 Hz, 60 Hz	±(113% rdg.l+5d)	±(15% rdg.l+4d)									
		100 mA ... 999 mA	1 mA				±(113% rdg.l+1d)	±(15% rdg.l+1d)								I 15A	
		1.00 A ... 9.99 A	0.01 A				±(111% rdg.l+4d)	±(14% rdg.l+3d)								II 150 A	
		10.0 A ... 15.0 A	0.1 A				±(111% rdg.l+1d)	±(14% rdg.l+1d)									
		0.0 mA ... 99.9 mA	0.1 mA	100 mV/A	5 mA ... 1000 mA	f <sub>N</sub> = 16.7 Hz, 50 Hz, 60 Hz, 200 Hz, 400 Hz	±(17% rdg.l+2d)	±(15% rdg.l+2d)									
		100 mA ... 999 mA	1 mA				±(17% rdg.l+1d)	±(15% rdg.l+1d)									1 A
		0.00 A ... 9.99 A	0.01 A				±(13.4% rdg.l+2d)	±(13% rdg.l+2d)									10 A
		0.00 A ... 9.99 A	0.01 A				±(3.1% rdg.l+2d)	±(3% rdg.l+2d)									100 A
		10.0 A ... 99.9 A	0.1 A	±(3.1% rdg.l+1d)	±(3% rdg.l+1d)	1000 A											
		0.00 A ... 9.99 A	0.01 A	±(3.1% rdg.l+1d)	±(3% rdg.l+1d)												
		10.0 A ... 99.9 A	0.1 A	±(3.1% rdg.l+2d)	±(3% rdg.l+2d)												
		100 A ... 999 A	1 A	±(3.1% rdg.l+1d)	±(3% rdg.l+1d)												
		0.0 mA ... 99.9 mA	0.1 mA	1 V/A	30 mA ... 1000 mA	f <sub>N</sub> = 50 Hz, 60 Hz	±(127% rdg.l+100d)	±(13% rdg.l+100d)									
		100 mA ... 999 mA	1 mA				±(127% rdg.l+11d)	±(13% rdg.l+11d)									3 A
		0.00 A ... 9.99 A	0.01 A				±(127% rdg.l+12d)	±(13% rdg.l+12d)									30 A
		0.00 A ... 9.99 A	0.01 A				±(127% rdg.l+11d)	±(13% rdg.l+11d)									300 A
10.0 A ... 99.9 A	0.1 A	±(127% rdg.l+100d)	±(13% rdg.l+100d)														
0.00 A ... 9.99 A	0.01 A	±(127% rdg.l+11d)	±(13% rdg.l+11d)														
10.0 A ... 99.9 A	0.1 A	±(127% rdg.l+11d)	±(13% rdg.l+11d)														
100 A ... 999 A	1 A	±(127% rdg.l+11d)	±(13% rdg.l+11d)														
0.00 A ... 9.99 A	0.01 A	10 mV/A	0.5 A ... 100 A	f <sub>N</sub> = DC, 16.7 Hz, 50 Hz, 60 Hz, 200 Hz	±(15% rdg.l+12d)	±(13% rdg.l+12d)											
10.0 A ... 99.9 A	0.1 A				±(15% rdg.l+2d)	±(13% rdg.l+2d)									100 A		
0.00 A ... 9.99 A	0.01 A				±(15% rdg.l+50d)	±(13% rdg.l+50d)									1000 A		
10.0 A ... 99.9 A	0.1 A				±(15% rdg.l+7d)	±(13% rdg.l+7d)											
100 A ... 999 A	1 A	±(15% rdg.l+2d)	±(13% rdg.l+2d)														

1 U > 230 V, with 2 or 3-pole adapter only  
 2 1 × I<sub>ΔN</sub> > 300 mA and 2 × I<sub>ΔN</sub> > 300 mA and 5 × I<sub>ΔN</sub> > 500 mA and I<sub>f</sub> > 300 mA only up to U<sub>N</sub> ≤ 230 V!  
 3 The transformation ratio selected at the clamp (1/10/100/1000 mV/A) must be set in the "Type" menu with the rotary switch in the "SENSOR" position.  
 4 Where R<sub>Eselective</sub>/R<sub>Etotal</sub> < 100  
 5 The specified measuring and intrinsic uncertainties already include those of the respective current clamp.  
 6 Measuring range of the signal input at the test instrument, U<sub>E</sub>: 0 ... 1.0 V<sub>eff</sub> (0 ... 1.4 V<sub>peak</sub>) AC/DC  
 7 Input impedance of the signal input at the test instrument: 800 kΩ

8 DC bias only possible with PROFITEST MXTRA  
 11 where Z<sub>L-PE</sub> < 0.6 Ω, I<sub>K</sub> > U<sub>N</sub>/0.5 Ω is displayed  
**Key:** d = digit(s), rdg. = reading (measured value)

# PROFITEST MASTER Series

## PROFITEST MTECH+, MPRO, MXTRA, MBASE+

### IEC 60364-6, EN 50110-1

#### Characteristic Values Special Measurements PROFITEST MPRO and PROFITEST MXTRA

Function	Measured Quantity	Display Range	Resolution	Test Current / Signal Frequency	Measuring range	Measuring Uncertainty	Intrinsic Uncertainty	Connections			
								Adapter for Test Plug PRO-RE	PRO-RE/2	Current Clamps Z3512A	Z591B
RE BAT	RE, 3-pole	0.00 Ω ... 9.99 Ω 10.0 Ω ... 99.9 Ω 100 Ω ... 999 Ω	0.01 Ω 0.1 Ω 1 Ω	16 mA/128 Hz 1.6 mA/128 Hz 0.16 mA/128 Hz	1.00 Ω ... 19.9 Ω 5.0 Ω ... 199 Ω 50 Ω ... 1.99 kΩ	±(10% rdg.l.+10d + 1 Ω)	±(3% rdg.l.+5d + 0.5 Ω)	2			
	RE, 4-pole	1.00 kΩ ... 9.99 kΩ 10.0 kΩ ... 50.0 kΩ	0.01 kΩ 0.1 kΩ	0.16 mA/128 Hz 0.16 mA/128 Hz	0.50kΩ ... 19.9kΩ 0.50kΩ ... 49.9kΩ	±(10% rdg.l.+10d)	±(3% rdg.l.+5d)				
	RE, 4-pole selective with clamp meter	0.00 Ω ... 9.99 Ω 10.0 Ω ... 99.9 Ω 100 Ω ... 999 Ω 1.00 kΩ ... 9.99 kΩ 10.0 kΩ ... 19.9 kΩ <sup>10</sup> 10.0 kΩ ... 49.9 kΩ <sup>11</sup>	0.01 Ω 0.1 Ω 1 Ω 0.01 kΩ 0.1 kΩ	16 mA/128 Hz 16 mA/128 Hz 1.6 mA/128 Hz 0.16 mA/128 Hz 0.16 mA/128 Hz 0.16 mA/128 Hz	1.00 Ω ... 9.99 Ω 10.0 Ω ... 200 Ω	±(15% rdg.l.+10d) ±(20% rdg.l.+10d) <sub>6</sub>	±(10% rdg.l.+10d) ±(15% rdg.l.+10d)	2		5	
	Soil resistivity (ρ)	0.0 Ωm ... 9.9 Ωm 100 Ωm ... 999 Ωm 1.00 Ωm ... 9.99 kΩm	0.1 Ωm 1 Ωm 0.01 kΩm	16 mA/128 Hz 1.6 mA/128 Hz 0.16 mA/128 Hz 0.16 mA/128 Hz	100 Ωm ... 9.99 kΩm <sup>8</sup> 500 Ωm ... 9.99 kΩm <sup>8</sup> 5.00 kΩm ... 9.99 kΩm <sup>9</sup> 5.00 kΩm ... 9.99 kΩm <sup>9</sup> 5.00 kΩm ... 9.99 kΩm <sup>9</sup>	±(20% rdg.l.+10d) <sub>7</sub>	±(12% rdg.l.+10d) <sub>7</sub>	2			
	Probe clearance d (p)	0.1 m ... 999 m									
	RE, 2 clamps	0.00 Ω ... 9.99 Ω 10.0 Ω ... 99.9 Ω 100 Ω ... 999 Ω 1.00 Ω ... 1.99 kΩ	0.01 Ω 0.1 Ω 1 Ω 0.01 kΩ	30 V / 128 Hz	0.10 Ω ... 9.99 Ω 10.0 Ω ... 99.9 Ω	±(10% rdg.l.+5d) ±(20% rdg.l.+5d)	±(5% rdg.l.+5d) ±(12% rdg.l.+5d)		3	5	4

<sup>1</sup> Signal frequency without interference signal

<sup>2</sup> PRO-RE (Z501S) adapter cable for test plug, for connecting earth probes (E-Set 3/4)

<sup>3</sup> PRO-RE/2 adapter cable for test plug, for connecting the E-CLIP2 generator clamp

<sup>4</sup> Generator clamp: E-CLIP2 (Z591B)

<sup>5</sup> Clamp meter: Z3512A (Z225A)

<sup>6</sup> Where  $R_{E,se}/R_E < 10$  or clamp meter current  $> 500 \mu A$

<sup>7</sup> Where  $R_{E,H}/R_E \leq 100$  and  $R_{E,E}/R_E \leq 100$

<sup>8</sup> Where  $d = 20$  m

<sup>9</sup> Where  $d = 2$  m

<sup>10</sup> Only where RANGE = 20 kΩ

<sup>11</sup> Only where RANGE = 50 kΩ or AUTO

**Key:** d = digit(s), rdg. = reading (measured value)



# PROFITEST MASTER Series

## PROFITEST MTECH+, MPRO, MXTRA, MBASE+

### IEC 60364-6, EN 50110-1

#### Reference Conditions

Line voltage	230 V $\pm$ 0.1 %
Line frequency	50 Hz $\pm$ 0.1 %
Measured qty. frequency	45 Hz ... 65 Hz
Measured qty. waveform	Sine (deviation between effective and rectified value $\leq$ 0.1 %)
Line impedance angle	$\cos \varphi = 1$
Probe resistance	$\leq 10 \Omega$
Supply voltage	12 V $\pm$ 0.5 V
Ambient temperature	+ 23 °C $\pm$ 2 K
Relative humidity	40% ... 60%
Finger contact	For testing potential difference to ground potential
Standing surface insulation	Purely ohmic

#### Power Supply

(Rechargeable) batteries	8 each AA 1.5 V We recommend using the included battery pack only (2000 mAh; Z502H))
Number of measurements (standard setup with illumination)	
– For $R_{INS}$	1 measurement – 25 s pause: approx. 1100 measurements
– for $R_{LO}$	Auto polarity reversal / 1 $\Omega$ (1 measuring cycle) – 25 s pause: approx. 1000 measurements
Battery test	Symbolic display of rechargeable battery voltage <b>BAT</b>
Battery-saving circuit	Display illumination can be switched off. The test instrument is switched off automatically after the last key operation. The user can select the desired on-time.
Safety shutdown	If supply voltage is too low, the instrument is switched off, or cannot be switched on.
Recharging socket	Inserted rechargeable batteries can be recharged directly by connecting a charger to the recharging socket: Z502R charger
Charging time	Z502R charger: approx. 2 hours *

\* Maximum charging time with fully depleted batteries.  
A timer in the charger limits charging time to no more than 4 hours.

#### Overload capacity

$R_{ISO}$	1200 V continuous
$U_{L-PE}$ , $U_{L-N}$	600 V continuous
RCD, $R_E$ , $R_F$	440 V continuous
$Z_{L-PE}$ , $Z_{L-N}$	550 V (Limits the number of measurements and pause duration. If overload occurs, the instrument is switched off by means of a thermostatic switch.)
$R_{LO}$	Electronic protection prevents switching on if interference voltage is present.
Protection with fine-wire fuses	FF 3.15 A 10 s, Fuses blow at > 5 A

#### Electrical Safety

Protection class	II
Nominal voltage	230/400 V (300/500 V)
Test voltage	3.7 kV, 50 Hz
Measuring category	CAT III 600 V or CAT IV 300 V
Pollution degree	2
Fuses	
L and N terminals	1 fuse link ea. FF 3.15 A/500G 6.3 mm $\times$ 32 mm

#### Electromagnetic Compatibility (EMC)

Product standard EN 61326-1

Interference emission		Class
EN 55022		A
Interference immunity	Test value	Feature
EN 61000-4-2	Contact/atmos. – 4 kV/8 kV	
EN 61000-4-3	10 V/m	
EN 61000-4-4	Mains connection – 2 kV	
EN 61000-4-5	Mains connection – 1 kV	
EN 61000-4-6	Mains connection – 3 V	
EN 61000-4-11	0.5 periods / 100%	

#### Ambient Conditions

Accuracy	0 ... + 40 °C
Operation	–5 ... + 50 °C
Storage	–20 ... + 60 °C (without batteries)
Relative humidity	max. 75%, no condensation allowed
Elevation	max. 2000 m

#### Mechanical Design

Display	Multiple display with dot matrix 128 x 128 pixels
Dimensions	W $\times$ L $\times$ H = 260 $\times$ 330 $\times$ 90 mm
Weight	Approx. 2.7 kg with batteries
Protection	Housing: IP 40, test probe: IP 20 per EN 60529

#### Data Interfaces

Type	USB for PC connection
Type	RS-232 for barcode and RFID readers
Type	Bluetooth® (only PROFITEST MTECH+/PROFITEST MXTRA) for PC connection and option for connecting a Bluetooth® keyboard (Bluetooth® Classic 3.0) Frequency range: 2.4 ... 2.4835 GHz Transmission intensity: max. +3 dBm

# PROFITEST MASTER Series

## PROFITEST MTECH+, MPRO, MXTRA, MBASE+

### IEC 60364-6, EN 50110-1

#### Special Measurements (all types)

##### Automatic test sequence function

If the same sequence of tests will be run frequently (one after the other with subsequent report generation), for example as specified in the standards, it's advisable to make use of test sequences.

Automated test sequences can be compiled from manually created individual measurements with the help of the test sequence function. A test sequence consists of up to 200 individual steps, which are executed one after the other.

The test sequences are created at the PC with the help of ETC software, and then transferred to the test instrument.

Measurement parameters are also configured at the PC. However, parameters can be changed at the test instrument during the test sequence before the respective measurement is started.

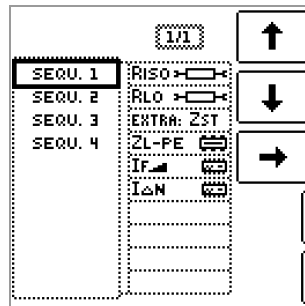

##### Voltage drop measurement (at $Z_{L-N}$ ) – $\Delta U$ function

According to IEC 60364-6, voltage drop from the intersection of the distribution network and the consumer system to the point of connection of an electrical power consumer (electrical outlet or device connector terminals) should not exceed 4% of nominal line voltage.

Voltage drop calculation:

$$\Delta U = Z_{L-N} \times \text{nominal current of the fuse}$$

$$\Delta U \text{ as \%} = \Delta U / U_{L-N}$$

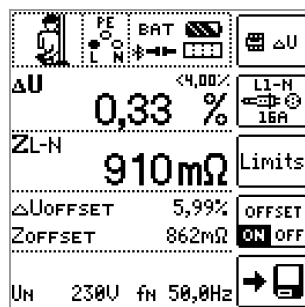
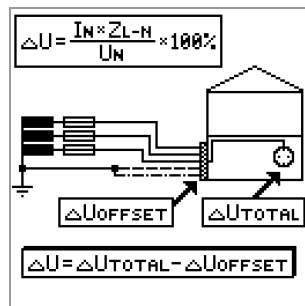

##### Measurement of the Impedance of Insulating Floors and Walls (standing surface insulation impedance) – $Z_{ST}$ Function

The instrument measures the impedance between a weighted metal plate and earth. Line voltage available at the measuring site is used as an alternating voltage source. The  $Z_{ST}$  equivalent circuit is considered a parallel circuit.

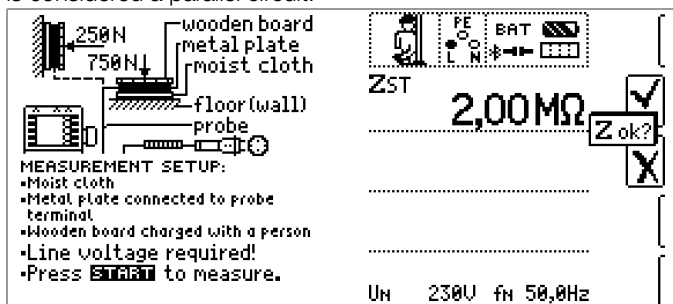

#### Special Measurements

##### PROFITEST MTECH+ and PROFITEST MXTRA

##### Tripping Test for Type B, AC/DC Sensitive RCCDs with Rising DC Residual Current and Measurement of Tripping Current

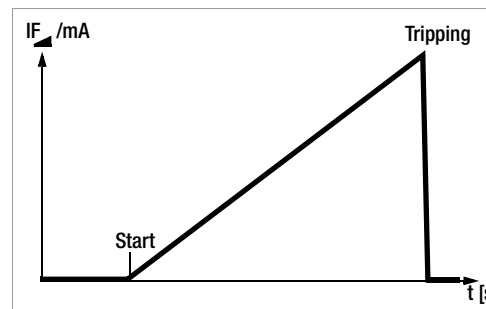

With the selector switch in the  $I_F$  position, slowly rising DC current flows via N and PE. The momentary measured current value is continuously displayed. When the RCCB is

tripped, the last measured current value is displayed. A greatly reduced rate of increase is used for delayed RCCBs (type **S**).

##### Tripping Test for Type B, AC/DC Sensitive RCCDs with Constant DC Residual Current and Measurement of Tripping Time

With the selector switch set to the respective nominal residual current, twice the selected nominal current flows via N and PE. Time to trip is measured for the RCCB and displayed.

##### Loop Resistance Measurement with Suppression of RCD Tripping

The test instruments make it possible to measure loop impedance in TN systems with type A, F and AC RCCBs (10, 30, 100, 300, 500 mA nominal residual current).

The respective test instrument generates a DC residual current to this end, which saturates the RCCB's magnetic circuit.

The test instrument then superimposes a measuring current which only demonstrates half-waves of like polarity. The RCCB is no longer capable of detecting this measuring current and is consequently not tripped during measurement.

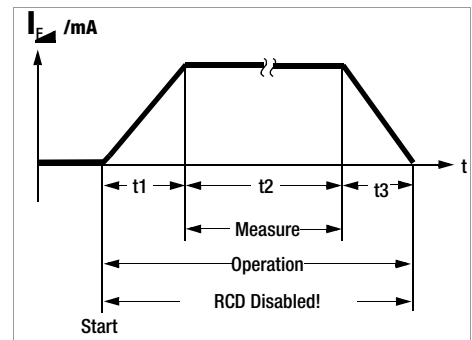

# PROFITEST MASTER Series

## PROFITEST MTECH+, MPRO, MXTRA, MBASE+

### IEC 60364-6, EN 50110-1

#### Selective Earth Resistance Measurement (mains powered)

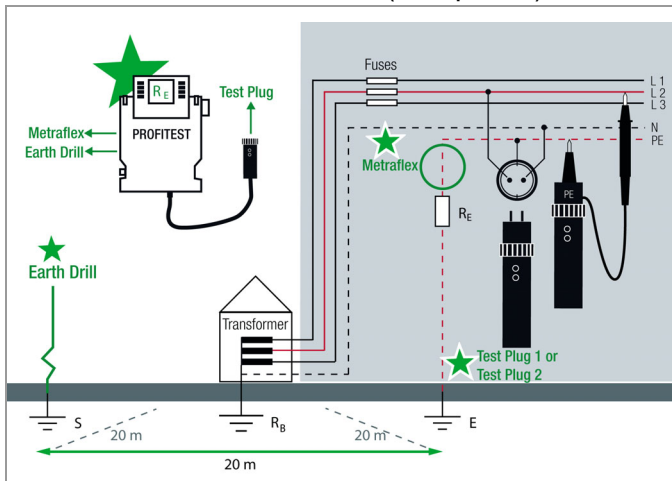

#### Checking the operating states of an electric vehicle at charging stations per IEC 61851- 1

In combination with an adapter, the operating state of an electric vehicle can be tested at charging points in accordance with IEC 61851-1. The adapter is used to simulate the various operating states of a fictitious electric vehicle connected to a charging station.

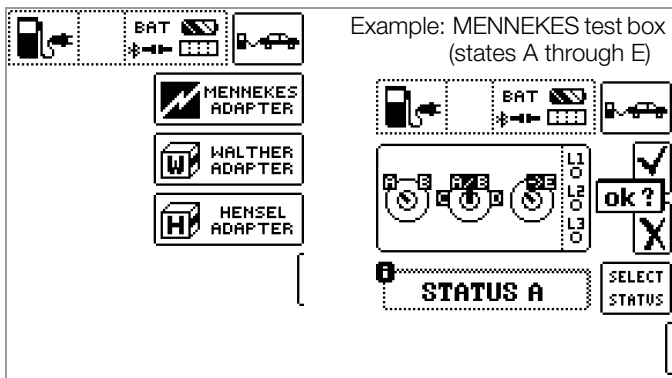

#### Special Measurements

#### PROFITEST MPRO and PROFITEST MXTRA

#### Battery Powered Earthing Resistance Measurements, "Battery Mode"

#### Earthing Resistance $R_E$

3-wire measuring method, probes and earth electrodes connected via PRO-RE adapter

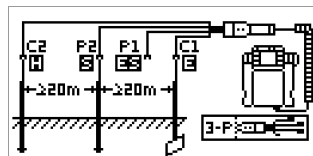

4-wire measuring method, probes and earth electrodes connected via PRO-RE adapter

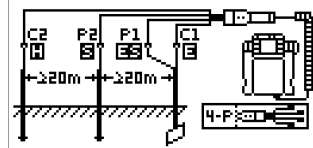

#### Selective Earthing Resistance $R_E$

(4-wire measuring method) Current clamp sensor connected directly, probes and earth electrodes connected via PRO-RE adapter

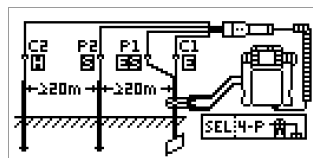

#### Earth Loop Resistance $R_{Eloop}$

2-clamp measurement: Current clamp sensor directly connected, current clamp transformer connected via PRO-RE/2 adapter

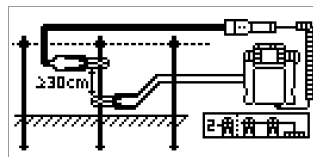

#### Soil Resistivity $R_{ho}$

Probes connected via PRO-RE

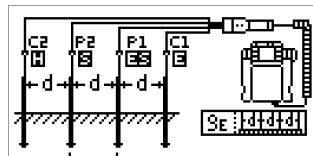

# PROFITEST MASTER Series

## PROFITEST MTECH+, MPRO, MXTRA, MBASE+

### IEC 60364-6, EN 50110-1

#### Special Measurements

##### PROFITEST MXTRA

###### Testing of insulation monitoring devices (IMDs)

Insulation monitors are used in power supplies for which a single-pole earth fault may not result in failure of the power supply, for example in operating rooms or photovoltaic systems.

Insulation monitors can be tested with the help of this special function. After pressing the START button, an adjustable insulation resistance is activated between one of the two phases of the IT system to be monitored and ground to this end. This resistance can be changed in the manual sequence mode with the help of the softkeys, and it can be varied automatically from  $R_{max}$  to  $R_{min}$  in the automatic operating mode.

Time during which the momentary resistance value prevails at the system until the next change in value is displayed. The IMD's display and response characteristics can be subsequently evaluated and documented with the help of the softkeys.

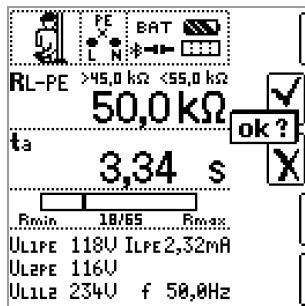
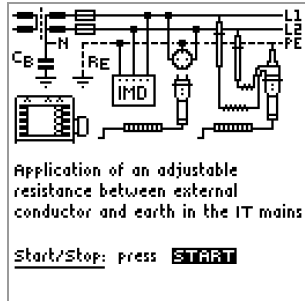

###### Leakage current measurement with PRO-AB adapter

Measurement of continuous leakage and patient auxiliary current per IEC 62353 / IEC 601-1 / EN 60 601-1 (Medical electrical equipment – General requirements for basic safety) is possible with the help of the PRO-AB leakage current measuring adapter used as an accessory with the PROFITEST MXTRA test instrument.

As specified in the standards listed above, current values of up to 10 mA can be measured with this measuring adapter.

In order to be able to fully cover this measuring range using the measurement input provided on the test instrument (2-pole current clamp input), the measuring instrument is equipped with range switching including transformation ratios of 10:1 and 1:1.

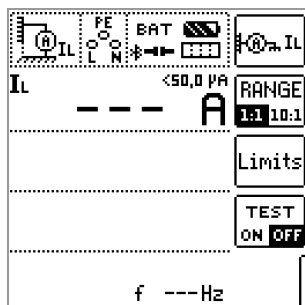
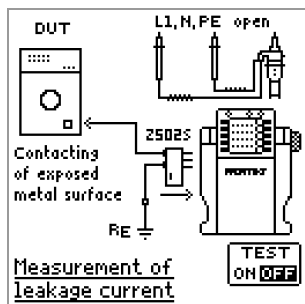

#### Determination of Residual Voltage / Detection of Mains Fluctuation

EN 60204 specifies that after switching supply power off, residual voltage between L and PE must drop to a value of 60 V or less within 5 seconds at all accessible, active components of a machine to which a voltage of greater than 60 V is applied during operation.

With the PROFITEST MXTRA, testing for the absence of voltage is performed as follows by means of a voltage measurement which involves measuring discharge time  $t_U$ :

In the case of voltage dips of greater than 5% of momentary line voltage (within 0.7 seconds), the stopwatch is started and momentary undervoltage is displayed as  $U_{res}$  after 5 seconds and indicated by the red  $U_L/R_L$  diode.

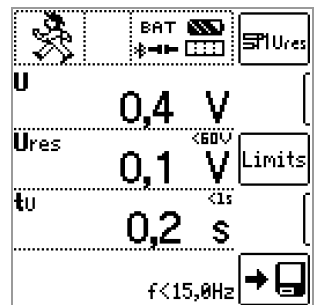
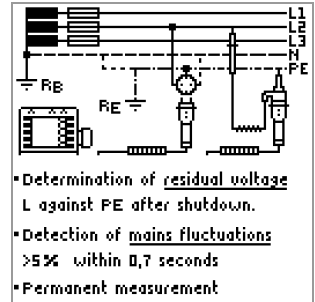

#### Intelligent Ramp

The advantage of this measuring function in contrast to individual measurement of  $I_{\Delta N}$  and  $t_A$  is the simultaneous measurement of breaking time and breaking current by means of a test current which is increased in steps, during which the RCD has to be tripped only once.

The intelligent ramp is subdivided into time segments of 300 ms each between the initial current value (35 %  $I_{\Delta N}$ ) and the final current value (130 %  $I_{\Delta N}$ ). This results in a gradation for which each step corresponds to a constant test current which is applied for no longer than 300 ms, assuming that tripping does not occur.

And thus both tripping current and tripping time are measured and displayed.

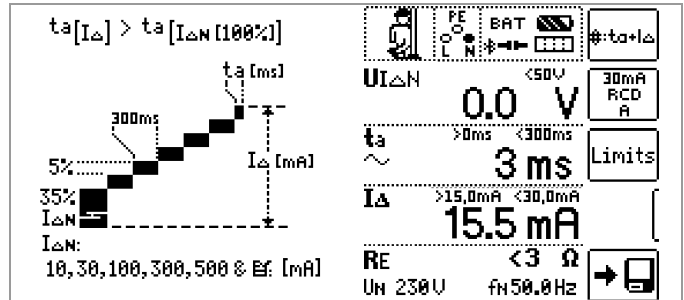

#### Testing Residual Current Monitoring Devices (RCMs)

Residual current monitors (RCMs) monitor residual current in electrical systems and display it continuously. As is also the case with residual current devices, external switching devices can be controlled in order to shut down supply power in the event that a specified residual current value is exceeded. However, the advantage of an RCM is that the user is informed of fault current within the system before shutdown takes place.

As opposed to individual measurement of  $I_{\Delta N}$  and  $t_A$ , measurement results must be evaluated manually in this case

# PROFITEST MASTER Series

## PROFITEST MTECH+, MPRO, MXTRA, MBASE+

### IEC 60364-6, EN 50110-1

If an RCM is used in combination with an external switching device, the combination must be tested as if it were an RCD.

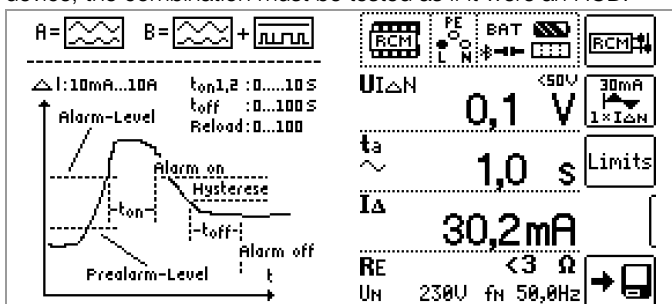

#### Test Sequences for Documenting Fault Simulations at type S and K PRCDs with the Optional PROFITEST PRCD Adapter

- There are three preset test sequences:
  - PRCD-S (single-phase)
  - PRCD-K (single-phase)
  - PRCD-S (3-phase)
- The test instrument runs through all test steps semi-automatically:
  - Single-phase PRCDs: PRCD-S: 11 test steps  
PRCD-K: 4 test steps
  - 3-phase PRCDs: PRCD-S: 18 test steps
- Each test step is evaluated and assessed by the user (go/no-go) for later documentation.
- Measurement of the PRCD's protective conductor resistance using the test instrument's  $R_{LO}$  function
- Measurement of the PRCD's insulation resistance using the test instrument's  $R_{ISO}$  function
- Tripping test with nominal residual current using the test instrument's  $I_F$  function
- Measurement of time to trip using the test instrument's  $I_{\Delta N}$  function.
- Varistor test for PRCD-K: measurement via ISO ramp

Further information is available in the data sheet for the PROFITEST PRCD.



Selecting the PRCD to be Tested:	Sample Simulation, Interruption:

# PROFITEST MASTER Series

## PROFITEST MTECH+, MPRO, MXTRA, MBASE+

### IEC 60364-6, EN 50110-1

#### Accessories

##### Report Generating Accessories

See also separate "ID systems" data sheet.

###### Barcode Profiscanner RS232 (Z502F)

Barcode reader and scanner for RS-232 connection to the test instrument for identifying systems, electrical circuits and operating equipment.

Supported barcodes: EAN13, CODE 39, CODE 128 and 2D codes (2D code capability including QR codes as of serial number G15 – approx. August 2015)



###### Barcode and Label Printer for USB Connection to a PC (Z721E)

Barcode/label printer for connection to a PC for self-adhesive, smudge-proof barcode labels – for identifying devices and system components. Devices and system components can be logged by our test instruments, and acquired measured values can be allocated to them with the scanner.



###### SCANBASE RFID Reader for Connection to the RS-232 Port at the Tester (Z751G)

The SCANBASE RFID is used to identify tools and equipment: The RFID reader scans the code and forwards it to our test instruments in order to unequivocally assign the measured values and test results to a device under test.



The SCANBASE RFID is preprogrammed to read the following RFID tags:

Article no.	Frequency	Standard	Layout	Quantity per Package
Z751R	13.56 MHz	ISO 15693	Dia. approx. 22 mm, self-adhesive	500 pieces
Z751S	13.56 MHz	ISO 15693	Dia. approx. 30 x 2 mm with 3 mm hole	500 pieces
Z751T	13.56 MHz	ISO 15693	Pigeon ring, dia. approx. 10mm	250 pieces

##### Power Supply Accessories

###### Master Battery Pack (Z502H)



With Angled Barrel Plug

###### Charger (Z502R)



##### Accessory Plug Inserts and Adapters

###### PRO-HB Test Probe and Measuring Adapter Holder (Z501V)



###### Country-Specific Plug Inserts



GTZ3228000R0001

- PRO-Schuko (GTZ3228000R0001) for Germany: earth contact plug
- PRO-W (Z503A) for Germany: angled earth contact plug
- PRO-W II (Z503V) for Germany: angled earth contact plug with PE socket
- PRO-GB/USA (Z503B)
- PRO-CH (GTZ3225000R0001)



###### Test Tips, Probe Set (Z503F)

Length 68 mm, dia. 2.3 mm



###### PRO-PE Clip – Flat Test Clip for Busbars (Z503G)



# PROFITEST MASTER Series

## PROFITEST MTECH+, MPRO, MXTRA, MBASE+

### IEC 60364-6, EN 50110-1

#### Magnetic Measuring Probes (patented) with Magnetic Strain Relief (Z502Z)

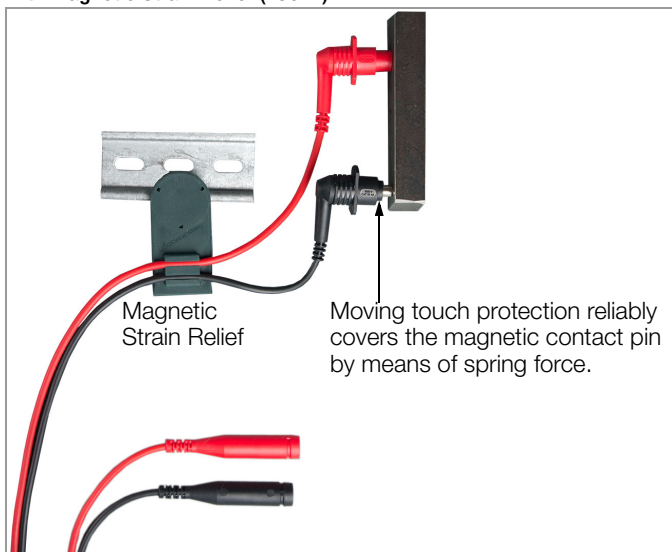

#### Safety Clip (Z503W)



#### Plug Inserts for PE and Other Similar Measurements



With 4-wire technology  
CAT IV, 300 V

- PRO-RLO-II (Z501P)  
Cable length: 10 m
- PRO-RLO 20 (Z505F)  
Cable length: 20 m
- PRO-RLO 50 (Z505G)  
Cable length: 50 m

#### PRO-UNI-II Plug Insert (Z501R)



3 connector cables for any connection standards  
CAT IV, 300 V

#### 5-pole 3-phase adapter



3-phase adapters

- A3-16  
(GTZ3602000R0001)
- A3-32  
(GTZ3603000R0001)  
and
- A3-63  
(GTZ3604000R0001)

permit trouble-free connection of test instruments to 5-pole CEE outlets. The three variants differ with

regard to plug size, which corresponds respectively to 5-pole CEE outlets with current ratings of 16, 32 and 63 A. Phase sequence is indicated with lamps at all three variants. Testing the effectiveness of safety measures is conducted via five 4 mm sockets with touch protection.

#### 7-pole 3-phase adapter



Shielded A3-16 and A3-32 three-phase adapters are used for trouble-free connection of test instruments to 7-pole CEE outlets.

The two variants differ with regard to plug size, which corresponds respectively to 7-pole CEE outlets with current ratings of 16 and 32 A.

Testing the effectiveness of safety measures is conducted via seven 4 mm sockets with touch protection.

#### VARIO Plug Adapter Set (Z500A)

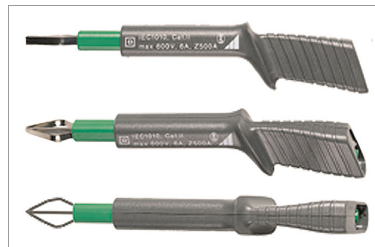

Three self-retaining test probes with touch protection for the connection of measurement cables with 4 mm banana plugs, or with touch protected plugs for sockets with an opening of 3.5 mm to 12 mm, e.g. CEE or Perilex sockets etc.

For example, the test probes also fit the square PE jacks on Perilex sockets. Maximum allowable operating voltage: 600 V per IEC 61010.

# PROFITEST MASTER Series

## PROFITEST MTECH+, MPRO, MXTRA, MBASE+

### IEC 60364-6, EN 50110-1

#### PRO-AB Leakage Current Measuring Adapter (Z502S) for PROFITEST MXTRA



Input current:  
0 ... 10 mA  
Input impedance:  
1 kΩ ±0.5%  
Output voltage:  
10:1: 0 ... 1 V (0.1 V/mA)  
1:1: 0 ... 10 V (1 V/mA)  
Output impedance 10 kΩ

#### ISO Calibrator 1 (M662A)

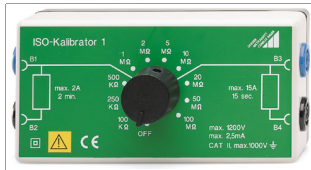

Calibration adapter for rapid, efficient testing of the accuracy of measuring instruments for insulation resistance and low-value resistors

#### KS24 Cable Set (GTZ3201000R0001)



The KS24 cable set includes a 4 m long extension cord with a permanently attached test probe at one end and a contact protected socket at the other end, as well as an alligator clip which can be plugged onto the test probe.

#### Telescoping Rods TELEARM 120 (Z505C) and TELEARM 180 (Z505D)



#### TELEARM Case (Z505E)



#### 1081 Floor Probe (GTZ3196000R0001)



The 1081 floor probe makes it possible to measure the resistance of insulating floors in accordance with IEC 60364-6 and EN 1081.

#### Current Clamp Sensor WZ12C

(Z219C)



Current clamp sensor for leakage current, selectable measuring ranges:  
1 mA ... 15 A, 3%  
and 1 A ... 150 A, 2%  
Transformation ratios:  
1 mV/mA, 1 mV/A

#### METRAFLEX P300 (Z502E)



Flexible current clamp sensor for selective earthing resistance measurement  
3/30/300 A,  
1 V/100 mV/10 mV/A

### Earth Measurement Accessories

#### PRO-RE/2 Clamp Adapter (Z502T)



Adapter which is mounted to the test plug allowing for connection of the E-Clip 2 generator clamp for 2-clamp or ground-loop earthing resistance measurement.  
2-clamp or ground loop measurement is thus made possible.

#### PRO-RE Adapter (Z501S)

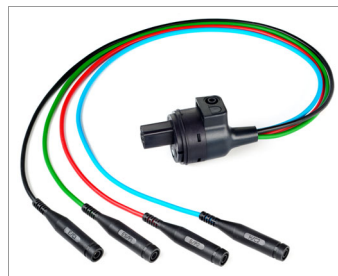

Earth electrodes, auxiliary earth electrodes, probe and auxiliary probe are connected to the tester via the banana plug sockets, and thus via the adapter which is mounted to the test plug.

#### E-CLIP 2 Clamp Generator (Z591B)



Measuring range:  
0.2 A ... 1200 A  
Measuring category:  
600 V CAT III  
Max. cable diameter: 52 mm  
Transformation ratio: 1000A/1A  
Frequency range: 40 Hz ... 5 kHz

Output signal: 0.2 mA ... 1.2 A  
Equipped with laboratory safety plug inputs

#### AC Current Clamp Sensor (Z3512A)



Switchable measuring ranges:  
1 mA... 1/100/  
1000 A AC  
Transmission ratios:  
1 V/A, 100 mV/A,  
10 mV/A; 1 mV/A



# PROFITEST MASTER Series

## PROFITEST MTECH+, MPRO, MXTRA, MBASE+ IEC 60364-6, EN 50110-1

TR25II Cable Reel (Z503X)



25 m measurement cable coiled onto a plastic reel. Connection to the inside end of the cable is made possible with two sockets integrated into the reel. The other end is equipped with a banana plug. Cable resistance can be compensated for with the rotary selector switch in the  $R_{LO}$  position.

TR50II Cable Reel (Z503Y)



50 m measurement cable coiled onto a plastic reel. Connection to the inside end of the cable is made possible with two sockets integrated into the reel. The other end is equipped with a banana plug. Cable resistance can be compensated for with the rotary selector switch in the  $R_{LO}$  position.

SP500 Earth Drill (Z503Z)



E-SET PROFESSIONAL (Z592Z)



E-SET BASIC (Z593A)



### Accessory Cases, Trolleys and Pouches

SORTIMO L-BOXX GM (Z503D)



Plastic system case, outside dimensions:  $W \times H \times D$   
450 × 255 × 355 mm

Z503E foam insert for test instrument and accessories must be ordered separately (see below).

Foam Insert for SORTIMO L-BOXX GM (Z503E)

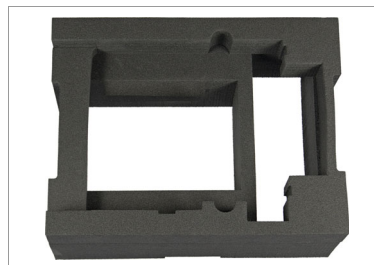

Profi-Case (Z502W)



Outside dimensions:  
 $H \times W \times D$   
390 × 590 × 230 mm

E-CHECK Case (Z502M)



Outside dimensions:  
 $H \times W \times D$   
390 × 590 × 230 mm

# PROFITEST MASTER Series

## PROFITEST MTECH+, MPRO, MXTRA, MBASE+

IEC 60364-6, EN 50110-1

### Sample Content



### Trolley for Profi-Case (Z502W) and E-CHECK Case (Z502N)

Folded delivery dimensions: 395 × 150 × 375 mm



### F2000 Universal Carrying Pouch (Z700D)



Outside dimensions:  
W × H × D  
380 × 310 × 200 mm  
(without buckles, handle  
or carrying strap)

### F2020 Large Universal Carrying Pouch (Z700F)



Outside dimensions:  
W × H × D  
430 × 310 × 300 mm  
(without buckles,  
handle or  
carrying strap)

### PROFITEST MASTER Ever-Ready Case (Z502X)



Back

Front with Test Instrument  
(test instrument not included)

# PROFITEST MASTER Series

## PROFITEST MTECH+, MPRO, MXTRA, MBASE+

### IEC 60364-6, EN 50110-1

#### E-Mobility Accessories

##### PROFITEST EMOBILITY (M513R)

Adapter for standards-compliant testing of single and 3-phase, mode 2 and 3 charging cables with simulation of faults in accordance with EN 50678 / DIN EN 50699 and the manufacturer's specifications



- Testing of mode 2 and 3, single and 3-phase charging cables
- Function test, i.e. tripping test by means of simulating the following faults: interruption, reversed wires and PE to phase
- Measurement of protective conductor current with current clamp transformer as accessory
- Measurement of protective conductor and insulation resistance

- Tripping test with nominal residual current and measurement of time to trip
- Evaluation and documentation of individual test steps

##### Test Adapter for Electric Charging Points (single/3-phase, type 2)

Single and 3-phase test adapter with type 2 plug for testing the effectiveness of protective measures at electric charging points:

- METRALINE PRO-TYP EM I (Z525F)
- METRALINE PRO-TYP EM II (Z525G): with earthing contact socket
- METRALINE PRO-TYP EM III (Z525H): with earthing contact socket and interchangeable test plug



- Vehicle simulation (CP): Vehicle states A through E are selected with a rotary switch.
- Cable simulation (PP): The various codings for charging cables with 13, 20, 32 and 63 A, as well as "no cable connected", can be simulated with the help of a rotary switch.
- Fault simulation: Simulation of a short-circuit between CP and PE by means of a rotary switch
- Indication of phase voltages via LEDs: Depending on the charging station, either one or three phases can be active.
- Testing of electric charging stations with permanently attached charging cable by means of an extended CP test pin

#### Fault Simulation Accessories

##### PROFSIM 1 (M560A)

Installation board with option for fault simulation for measurements per IEC 60364-6 and EN 50110 for training and project work.

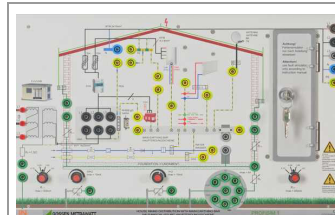

M560A

Service line with main grounding busbar, external and internal lightning protection, earth measurements, TN/TT systems

##### PROFSIM 2 (M560B)

Installation board with option for fault simulation for measurements per IEC 60364-6 and EN 50110 for training and project work.

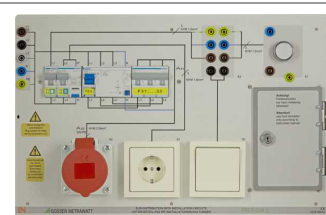

M560B

Sub-distribution branch with installation circuits, RCD type B, RCBO (FI/LS)

Further information regarding accessories can be found:

- in our Measuring Instruments and Testers catalog
- on the Internet at [www.gossenmetrawatt.com](http://www.gossenmetrawatt.com)

# PROFITEST MASTER Series

## PROFITEST MTECH+, MPRO, MXTRA, MBASE+

### IEC 60364-6, EN 50110-1

#### Scope of Delivery

Standard equipment of the PROFITEST MASTER series:

- 1 Test instrument
- 1 Earthing contact plug insert, country-specific (PRO-SCHUKO / GTZ3228000R0001)
- 1 2-pole measuring adapter and cable for expansion into a 3-pole adapter (PRO-A3-II / Z5010)
- 2 Alligator clips
- 1 Shoulder strap
- 1 Compact battery pack (Z502H)
- 1 Charger (Z502R)
- 1 USB cable
- 1 DAkkS calibration certificate
- 1 Condensed operating instructions \*
- 1 ETC software \*\*

\* Set of complete operating instructions available on the Internet for download from [www.gossenmetrawatt.com](http://www.gossenmetrawatt.com)

\*\* Download from Internet

Refer to the order information below for further accessories and instrument sets with additional accessories for specific testing purposes.

#### Order Information

Test instruments from the PROFITEST MASTER series can be ordered with the standard scope of delivery.

Refer to the scope of delivery on page 3 with regard to the differences between the instrument variants

Accessories can also be ordered separately. Data sheets are available separately for some products, in which additional information can be found. These are indicated with a <sup>D</sup> in the table.

Each product is identified with its article number, by means of which it can also be ordered.

#### Test Instruments – Standard Scope of Delivery

Designation	Description / Scope of Delivery	Article Number
PROFITEST MBASE+	PROFITEST MBASE+ test instrument (M520S) with standard scope of delivery	M520S
PROFITEST MXTRA	Test instrument PROFITEST MXTRA (M520P) with standard scope of delivery	M520P
PROFITEST MTECH+	Test Instrument PROFITEST MTECH+ (M520R) with standard scope of delivery	M520R
PROFITEST MPRO	Test instrument PROFITEST MPRO (M520N) with standard scope of delivery	M520N

#### Report Generating Accessories

Designation	Description	Article Number
Barcode Profiscanner RS-232 <sup>D</sup>	Barcode scanner for RS-232 connection with coil cable (approx. 1 m long)	Z502F
SCANBASE RFID <sup>D</sup>	RFID reader/writer	Z751G

#### Power Supply Accessories

Designation	Description	Article Number
Master Battery Pack	8 rechargeable LSD-NiMH batteries (2000 mAh), sealed with two plastic caps to form one battery pack	Z502H
Charger	Broad-range charger for charging the battery pack inserted in the test instrument (Z502H) Input: 100 ... 240 V <sub>AC</sub> Output: 16.5 V <sub>DC</sub> , 1 A	Z502R

#### Accessory Cases and Trolleys

Designation	Description	Article Number
PROFITEST MASTER ever-ready case	Ever-ready case with external pockets for accessories	Z502X
E-CHECK-Case	Aluminum case for test instrument and accessories	Z502M
Trolley for E-CHECK-Case	Trolley to which the E-CHECK case can be mounted	Z502N
F2000 <sup>D</sup>	Universal carrying pouch	Z700D
F2020 <sup>D</sup>	Large universal carrying pouch	Z700F
SORTIMO L-BOXX GM	Plastic system case	Z503D
Foam SORTIMO L-BOXX Profitest M	Foam insert for SORTIMO L-BOXX GM with compartment for test instrument	Z503E
Profi-Case	Profi-Case printed with content layout for sets including test instrument plus accessories, with trolley mount	Z502W

#### Accessories – Plug Inserts, Plugs, Measuring Attachments etc.

Designation	Description	Article Number
PRO-HB	Holder for test probes and measuring adapter	Z501V
PRO-Schuko	Plug insert, earthing contact plug: D, A, NL, F etc.	GTZ3228000R0001
PRO-W	Plug insert, angled earthing contact plug: D, A, NL, F etc.	Z503A
PRO-W II	Plug insert, angled earthing contact plug with PE socket	Z503V
PRO-CH	Plug insert per SEV: CH	GTZ3225000R0001
PRO-GB/USA	Plug insert with adapter for GB and USA	Z503B
Probe Set	Test probe set (red/black) CAT III 600 V, 1 A Length 68 mm, dia. 2.3 mm	Z503F
Safety Clip	Safety clips (red/blue) with hook, CAT IV 1 kV, 20 A	Z503W
PRO-PE Clip	Flat test clip for contacting busbars quickly and safely. Good contact at the front and back of the busbar thanks to time-tested contact blades. Rigid 4 mm socket in the handle, suitable for the insertion of spring-loaded 4 mm plugs with rigid insulating sleeve. CAT IV 1000 V, 32 A	Z503G
Magnetic Test Probes	2 touch-guarded magnetic test probes, with magnetic holder, 4 mm sockets, CAT III 1000 V, 4 A	Z502Z
PRO-RLO-II	Plug insert for PE and other similar measurements, 2-wire measuring technology, cable length: 10 m, CAT I 300 V, 16 A	Z501P
PRO-RLO 20	Measuring adapter for PE and other similar measurements, cable length: 20 m, CAT III 600 V	Z505F
PRO-RLO 50	Measuring adapter for PE and other similar measurements, cable length: 50 m, CAT III 600 V	Z505G
PRO-UNI-II	Plug insert with 3 connector cables for any connection standards, CAT IV 300 V, 16 A	Z501R
Z500A	VARIO plug adapter set (3 self-retaining, contact protected test probes for the connection of measurement cables with 4 mm banana plugs, or with contact protected plugs for sockets with an opening of 3.5 mm to 12 mm, e.g. CEE or Perilex sockets) 600 V per IEC 61010	Z500A

# PROFITEST MASTER Series

## PROFITEST MTECH+, MPRO, MXTRA, MBASE+

### IEC 60364-6, EN 50110-1

#### Accessories – Extensions

Designation	Description	Article Number
KS24	Extension cord, 4 m	GTZ3201000R0001
TELEARM 120 <sup>D</sup>	Telescoping rod for RLO and RINS measurements, CAT III 600 V / CAT IV 300 V, 1 A, retracted: 53.5 cm, extended: 120 cm, 190 g	Z505C
TELEARM 180 <sup>D</sup>	Telescoping rod for RLO and RINS measurements, CAT III 600 V / CAT IV 300 V, 1 A, retracted: 73.5 cm, extended: 180 cm, 250 g	Z505D
TELEARM Case	Pouch for TELEARM 120/180 L x W: 920x 170 mm	Z505E

#### Accessory Test Probes and Sensors

Designation	Description	Article Number
Probe 1081	Triangular probe for floor measurements in accordance with EN 1081 and IEC 60364	GTZ3196000R0001
WZ12C <sup>D</sup>	Current clamp sensor for leakage current, switchable: 1 mA ... 15 A, 3% and 1 A ... 150 A, 2%	Z219C
METRAFLEX P300	Flexible AC current sensor, 3/30/300 A, 1 V/100 mV/10 mV/A, with batteries, probe length: 45 cm	Z502E

#### Accessory Adapters

Designation	Description	Article Number
PROFITEST PRCD <sup>D</sup>	Test adapter for testing portable safety switches (types PRCD-K and PRCD-S) with the help of the PROFITEST MXTRA (instrument not included)	M512R
PRO-A3-II	2 and 3-pole measuring adapter for 3-phase and rotating-field systems, with coil cables, 300 V/1 A CAT IV with protective cap 600 V/1 A CAT III with protective cap 600 V/16 A CAT II without protective cap	Z5010
PRO-A3-II NCC	2 and 3-pole measuring adapter for 3-phase and rotating-field systems, with straight cables (10 m), 300 V/1 A CAT IV with protective cap 600 V/1 A CAT III with protective cap 600 V/16 A CAT II without protective cap	Z503C
A3-16	5-pole 3-phase adapter for 16 A CEE outlets	GTZ3602000R0001
A3-32	5-pole 3-phase adapter for 32 A CEE outlets	GTZ3603000R0001
sA3-63	5-pole 3-phase adapter for 63 A CEE outlets	GTZ3604000R0001
A3-16 Shielded	7-pole 3-phase adapter Shielded for 16 A CEE outlets, 32 A, CAT III 300 V, 10 A	Z513A
A3-32 Shielded	7-pole 3-phase adapter Shielded for 32 A CEE outlets, 32 A, CAT III 300 V, 10 A	Z513B
ISO Calibrator 1	Calibration adapter for testing the accuracy of measuring instruments for insulation resistance and low-value resistance	M662A
PRO-AB	Leakage current measuring adapter as an accessory with PROFITEST MXTRA (instrument not included)	Z502S

#### Earth Measurement Accessories

Designation	Description	Article Number
PRO-RE/2	Measuring adapter for connecting a second clamp (generator clamp), permits 2-clamp measuring method (ground loop measurement)	Z502T
PRO-RE	Connection adapter for earthing accessories for 3/4-wire measurement and selective earthing resistance measurement	Z501S

Designation	Description	Article Number
E-CLIP 2	Generator clamp for 2-clamp measuring method (ground loop measurement) Transformation ratio: 1000A/1A Current measuring range: 0.2 A ... 1200 A Output signal: 0.2 mA ... 1.2 A	Z591B
Z3512A <sup>D</sup>	Current clamp sensor for selective earthing measurement and as a clamp meter for the 2-clamp measuring method (earth loop measurement), clamp opening dia. 52 mm, selectable measuring ranges AC 0.001...1/10/100/1000 A, transformation ratios AC: 1 V/A 100 mV/A 10 mV/A 1 mV/A, frequency range 10...48...65...3kHz, intrinsic error ± (0.7% ... 0.2%), CAT III 600 V, cable length 1.5 m	Z225A
TR25II	Cable reel with 25 m measurement cable for low-resistance and earth measurements	Z503X
TR50II	Cable reel with 50 m measurement cable for low-resistance and earth measurements	Z503Y
SP500 earth drill	Earth drill, 50 cm long	Z503Z
E-SET PROFESSIONAL	Earth Measurement Accessories Consisting of one carrying pouch, four 500 mm earth drills, one 40 m blue measurement cable on cable reel with hand strap, one 20 m red measurement cable on cable reel with hand strap, one 5 m black measurement cable, one 5 m green measurement cable, one black test clamp with 4 mm socket, one green test clamp with 4 mm socket, one hammer, one reel tape measure, one dust cloth, one pad with pen	Z592Z
E-SET BASIC	Accessories for earth measurement including one rugged outdoor carrying pouch, two 420 mm earth drills, one 40 m blue measurement cable on cable reel with hand strap (1 kV CAT III), one 20 m red measurement cable on cable reel with hand strap (1 kV CAT III), one 2 m black measurement cable (1 kV CAT IV), one 2 m green measurement cable (1 kV CAT IV), one 30 cm red measurement cable (1 kV CAT IV), one 30 cm blue measurement cable (1 kV CAT IV), one black test clamp with 4 mm socket, one green test clamp with 4 mm socket	Z593A
E-Set 5	Earth measurement case consisting of imitation leather case including one reel with 25 m measurement cable, two reels with 50 m measurement cable each, three 0.5 m measurement cables, one 2 m measurement cable, one test clamp, four 350 mm earth drills, one dust cloth, two pads with forms	Z590B

# PROFITEST MASTER Series

## PROFITEST MTECH+, MPRO, MXTRA, MBASE+

### IEC 60364-6, EN 50110-1

#### E-Mobility Accessories

Designation	Description	Article Number
PROFITEST EMOBILITY	Test adapter for testing of mode 2 and 3, single and 3-phase charging cables	M513R
METRALINE PRO-TYP EM I	Single and 3-phase test adapter for testing the effectiveness of protective measures at electric charging points, simulation of fictitiously connected electric vehicles and simulation of current-carrying capacity of cord sets per IEC 61851-1, measurement inputs: 4 mm safety sockets for L1, L2, L3, N and PE for the test instrument, CP socket	Z525F
METRALINE PRO-TYP EM II	Single and 3-phase test adapter for testing the effectiveness of protective measures at electric charging points, simulation of fictitiously connected electric vehicles and simulation of current-carrying capacity of cord sets per IEC 61851-1, measurement inputs: 4 mm safety sockets for L1, L2, L3, N, PE and earthing contact socket for the test instrument, CP socket	Z525G
METRALINE PRO-TYP EM III	Single and 3-phase test adapter for testing the effectiveness of protective measures at electric charging points, simulation of fictitiously connected electric vehicles and simulation of current-carrying capacity of cord sets per IEC 61851-1, measurement inputs: 4 mm safety sockets for L1, L2, L3, N, PE and earthing contact socket for the test instrument, CP socket, interchangeable type 2 test plug	Z525H

#### Fault Simulation Accessories

Designation	Description	Article Number
PROFISIM 1	Installation board with option for fault simulation for measurements per IEC 60364-6 and EN 50110-1, service line with main grounding busbar, external and internal lightning protection, earth measurements, TN/TT systems	M560A
PROFISIM 2	Installation board with option for fault simulation for measurements per IEC 60364-6 and EN 50110, Sub-distribution branch with installation circuits, RCD type B, RCBO (FI/LS)	M560B

© Gossen Metrawatt GmbH

Prepared in Germany • Subject to change without notice / Errors excepted • A PDF version is available on the Internet

All trademarks, registered trademarks, logos, product names, and company names are the property of their respective owners.

 **GOSSEN METRAWATT**  
Gossen Metrawatt GmbH  
Südwestpark 15  
90449 Nürnberg • Germany

Phone +49 911 8602-0  
Fax +49 911 8602-669  
E-Mail [info@gossenmetrawatt.com](mailto:info@gossenmetrawatt.com)  
[www.gossenmetrawatt.com](http://www.gossenmetrawatt.com)