

# **PROFITEST MASTER Series**

## **PROFITEST MTECH+, MPRO, MXTRA, MBASE+**

### **IEC 60364-6, EN 50110-1**

3-447-149-03  
1/2.23



Table of Contents		Page	Page
<b>1</b>	<b>Safety Instructions</b> .....	<b>4</b>	
<b>2</b>	<b>Applications</b> .....	<b>5</b>	
2.1	Intended Use / Use for Intended Purpose .....	5	
2.2	Use for Other than Intended Purpose .....	5	
2.3	Liability and Guarantee.....	5	
2.4	Opening the Instrument / Repairs.....	5	
2.5	Scope of Functions.....	5	
<b>3</b>	<b>Documentation</b> .....	<b>6</b>	
<b>4</b>	<b>Getting Started</b> .....	<b>6</b>	
<b>5</b>	<b>The Instrument</b> .....	<b>7</b>	
5.1	Scope of Delivery .....	7	
5.2	Optional Accessories (excerpt) .....	7	
5.3	Meanings of Symbols on the Instrument.....	7	
5.4	Instrument Overview .....	8	
5.5	Technical Data .....	10	
5.6	Characteristic Values for PROFITEST MTECH+ and PROFITEST MBASE+.....	11	
5.7	Characteristic Values for PROFITEST MXTRA and PROFITEST MPRO .....	13	
<b>6</b>	<b>Operating and Display Elements</b> .....	<b>16</b>	
6.1	Control Panel .....	16	
6.2	Display .....	16	
6.3	LEDs.....	16	
6.4	LED Indications, Mains Connections and Potential Differences .....	17	
<b>7</b>	<b>Operation</b> .....	<b>26</b>	
7.1	Power Supply .....	26	
7.1.1	Inserting or Replacing the Battery Pack (Z502H) or Commercially Available Individual (Rechargeable) Batteries .....	26	
7.1.2	Charging the Battery Pack (Z502H) in the Tester .....	26	
7.2	Switching the Instrument On/Off .....	26	
<b>8</b>	<b>Instrument Settings</b> .....	<b>27</b>	
<b>9</b>	<b>Database</b> .....	<b>31</b>	
9.1	Creating Distributor Structures, General .....	31	
9.2	Transferring Distributor Structures.....	31	
9.3	Creating a Distributor Structure in the Test Instrument.....	31	
9.3.1	Creating Structures (example for electrical circuit).....	33	
9.3.2	Searching for Structure Elements.....	34	
9.4	Saving Data and Generating Reports .....	34	
9.5	Use of Barcode Scanners and RFID Readers.....	35	
<b>10</b>	<b>General Information on Measurements</b> .....	<b>36</b>	
10.1	Using Cable Sets and Test Probes.....	36	
10.2	Test Plug – Changing Inserts.....	36	
10.3	Connecting the Instrument .....	36	
10.4	Automatic Settings, Monitoring and Shutdown...36		
10.5	Measured Value Display and Memory .....	36	
10.6	Help Function.....	37	
10.7	Setting Parameters or Limit Values using RCD Measurement as an Example .....	38	
10.8	Freely Selectable Parameter Settings or Limit Values .....	39	
10.8.1	Changing Existing Parameters .....	39	
10.8.2	Adding New Parameters .....	39	
10.9	2-Pole Measurement with Rapid or Semiautomatic Polarity Reversal.....	40	
<b>11</b>	<b>Measuring Voltage and Frequency</b> .....	<b>41</b>	
11.1	Single-Phase Measurement.....	41	
11.1.1	Voltage Between L and N ( $U_{L-N}$ ), L and PE ( $U_{L-PE}$ ) and N and PE ( $U_{N-PE}$ ) with Country- Specific Plug Insert, e.g. SCHUKO.....	41	
11.1.2	Voltage Between L – PE, N – PE and L – L with 2-Pole Adapter Connection .....	41	
11.2	3-Phase Measurement (line-to-line voltage) and Phase Sequence.....	41	
<b>12</b>	<b>Testing RCDs</b> .....	<b>43</b>	
12.1	Measuring Touch Voltage (with reference to nomi- nal residual current) with 1/3 Nominal Residual Current and Tripping Test with Nominal Residual Current.....	44	
12.2	Special Tests for Systems and RCDs.....	46	
12.2.1	Testing Systems and RCCBs with Rising Residual Current (AC) for Type AC, A/F, B/B+ and EV/MI RCDs (PROFITEST MTECH+, PROFITEST MXTRA only).....	46	
12.2.2	Testing Systems and RCCBs with Rising Residual Current (AC) for Type B/B+ and EV/MI RCDs (PROFITEST MTECH+PROFITEST MXTRA) .....	47	
12.2.3	Testing RCCBs with $5 \times I_{\Delta N}$ .....	47	
12.2.4	Testing of RCCBs which are Suitable for Pulsating DC Residual Current .....	48	
12.3	Testing of Special RCDs.....	48	
12.3.1	Systems with Type RCD-S Selective RCCBs .....	48	
12.3.2	PRCDs with Non-Linear Type PRCD-K Elements.....	49	
12.3.3	SRCD, PRCD-S (SCHUKOMAT, SIDOS or comparable).....	50	
12.3.4	Type G or R RCCB .....	50	
12.4	Testing Residual Current Circuit Breakers in TN-S Systems.....	51	
12.5	Testing of RCD Protection in IT Systems with High Cable Capacitance (e.g. In Norway).....	52	
12.6	Testing of 6 mA Residual Current Devices RDC- DD/RCMB (RDC-DD: PROFITEST MXTRA and PROFITEST MTECH+ only) .....	52	
<b>13</b>	<b>Testing of Breaking Requirements for Overcurrent Protective Devices, Measurement of Loop Impedance and Determina- tion of Short-Circuit Current (<math>Z_{L-PE}</math> and <math>I_{SC}</math> Functions).....</b>	<b>54</b>	
13.1	Measurements with Suppression of RCD Tripping (PROFITEST MTECH+, PROFITEST MXTRA only) .....	54	
13.1.1	Measurement with Positive Half-Waves (PROFITEST MTECH+, PROFITEST MXTRA only).....	55	
13.2	Evaluation of Measured Values.....	55	

13.3	Settings for Calculating Short-Circuit Current – Parameter $I_{SC}$ .....	56	<b>19</b>	<b>Special Functions – EXTRA Switch Position .....</b>	<b>81</b>
<b>14</b>	<b>Measuring Supply Impedance (<math>Z_{L-N}</math> Function) .....</b>	<b>57</b>	19.1	Voltage Drop Measurement (at ZLN) – $\Delta U$ Function .....	82
<b>15</b>	<b>Earthing Resistance Measurement (Function <math>R_E</math>) .....</b>	<b>59</b>	19.2	Measuring the Impedance of Insulating Floors and Walls (standing surface insulation impedance) – $Z_{ST}$ Function .....	83
15.1	Earthing Resistance Measurement – Mains Powered .....	60	19.3	Testing Meter Startup with Earthing Contact Plug – kWh Function .....	84
15.2	Earthing Resistance Measurement – Battery Powered, “Battery Mode” (PROFITEST MPRO & PROFITEST MXTRA only) .....	60	19.4	Leakage Current Measurement with PRO-AB Leakage Current Adapter as Accessory – $I_L$ Function (PROFITEST MXTRA only) .....	85
15.3	Earthing Resistance, Mains Powered – 2-Pole Measurement with 2-Pole Adapter or Country-Specific Plug (Schuko) without Probe .....	61	19.5	Testing Insulation Monitoring Devices – IMD Function (PROFITEST MXTRA only) .....	86
15.4	Earthing Resistance Measurement. Mains Powered – 3-Pole Measurement: 2-Pole Adapter with Probe .....	62	19.6	Residual Voltage Test – $U_{res}$ Function (PROFITEST MXTRA only) .....	88
15.5	Earthing Resistance Measurement, Mains Powered – Measuring Earth Electrode Potential ( $U_E$ Function) .....	63	19.7	Intelligent Ramp – ta+ID Function (PROFITEST MXTRA only) .....	89
15.6	Earthing Resistance Measurement, Mains Powered – Selective Earthing Resistance Measurement with Current Clamp Sensor as Accessory .....	64	19.8	Testing Residual Current Monitors – RCM Function (PROFITEST MXTRA only) .....	90
15.7	Earthing Resistance Measurement, Battery Powered, “Battery Mode” – 3-Pole (PROFITEST MPRO & PROFITEST MXTRA only) .....	66	19.9	Checking the Operating Statuses of Electric Vehicles at Charging Stations per IEC 61851 (PROFITEST MTECH+ & PROFITEST MXTRA) ..	91
15.8	Earthing Resistance Measurement, Battery Powered, “Battery Mode” – 4-Pole (PROFITEST MPRO & PROFITEST MXTRA only) .....	67	19.10	PRCD – Test Sequences for Documenting Fault Simulations at PRCDs with the PROFITEST PRCD Adapter (PROFITEST MXTRA only) .....	92
15.9	Earthing Resistance Measurement, Battery Powered, “Battery Mode” – Selective (4-pole) with Current Clamp Sensor and PRO-RE Measuring Adapter as Accessory (PROFITEST MPRO & PROFITEST MXTRA only) .....	69	19.10.1	Fault Simulation .....	92
15.10	Earthing Resistance Measurement, Battery Powered, “Battery Mode” – Ground Loop Measurement (with current clamp sensor and transformer, and pro-re measuring adapter as accessory) (PROFITEST MPRO & PROFITEST MXTRA only) .....	70	<b>20</b>	<b>Test Sequences (Automatic Test Sequences) – AUTO Function .....</b>	<b>95</b>
15.11	Earthing Resistance Measurement, Battery Powered, “Battery Mode” – Measurement of Soil Resistivity $\rho_E$ (PROFITEST MPRO & PROFITEST MXTRA only) .....	71	20.1	General (test sequence layouts) .....	95
<b>16</b>	<b>Measurement of Insulation Resistance .....</b>	<b>73</b>	20.2	Creation of Test Sequences with ETC .....	95
16.1	General .....	73	20.3	Using Test Sequences .....	96
16.2	Special Case: Earth Leakage Resistance ( $R_{EISO}$ ) ..	75	<b>21</b>	<b>Maintenance .....</b>	<b>97</b>
<b>17</b>	<b>Measuring Low-Value Resistance of up to 200 <math>\Omega</math> (Protective Conductor and Equipotential Bonding Conductor) .....</b>	<b>77</b>	21.1	Test Instrument Firmware/Software .....	97
17.1	Measurement with Constant Test Current .....	78	21.1.1	Rechargeable Battery Care .....	97
17.2	Protective Conductor Resistance Measurement with Ramp Sequence – Measurement at PRCDs with Current-Monitored Protective Conductor using the PROFITEST PRCD Test Adapter as an Accessory (PROFITEST MXTRA only) .....	79	21.2	Fuse Replacement .....	97
<b>18</b>	<b>Measurement with Accessory Sensors .....</b>	<b>80</b>	21.3	Housing .....	97
18.1	Current Measurement with Current Clamp Sensor .....	80	21.4	Calibration .....	97
			<b>22</b>	<b>Contact, Support and Service .....</b>	<b>98</b>
			<b>23</b>	<b>CE Declaration .....</b>	<b>98</b>
			<b>24</b>	<b>Disposal and Environmental Protection .....</b>	<b>99</b>
			<b>25</b>	<b>Appendix .....</b>	<b>100</b>
			25.1	Tables for Determining Maximum and Minimum Display Values in Consideration of the Instrument’s Maximum Measuring and Intrinsic Uncertainties .....	100
			25.2	At which values should/must an RCD actually be tripped? Requirements for Residual Current Devices (RCD) .....	102
			25.3	Testing Electrical Machines per DIN EN 60204 – Applications, Limit Values .....	103
			25.4	Periodic Testing per DGUV V 3 (previously BGV A3) – Limit Values for Electrical Systems and Operating Equipment .....	103
			25.5	Bibliography .....	104
			25.6	Internet Addresses for Additional Information ..	104

# 1 Safety Instructions

Observe this documentation, in particular all included safety information, in order to protect yourself and others from injury, and to prevent damage to the instrument.

The operating instructions and the condensed operating instructions should be made available to all users.

## General

- Tests/measurements may only be performed by a qualified electrician, or under the supervision and direction of a qualified electrician. The user must be instructed by a qualified electrician concerning performance and evaluation of tests and/or measurements.
- Observe the five safety rules in accordance with DIN VDE 0105-100:2015-10, VDE 0105-100:2015-10 (EN 50110-1), Operation of electrical installations – Part 100: General requirements (1: Shut down entirely. 2: Secure against restart. 3: Assure absence of voltage at all poles. 4: Ground and short circuit. 5: Cover neighboring live components, or make them inaccessible).
- Observe and comply with all safety regulations which are applicable for your work environment.
- Wear suitable and appropriate personal protective equipment (PPE) whenever working with the instrument.
- The functioning of active medical devices (e.g. pacemakers, defibrillators) and passive medical devices may be affected by voltages, currents and electromagnetic fields generated by the tester and the health of their users may be impaired. Implement corresponding protective measures in consultation with the manufacturer of the medical device and your physician. If any potential risk cannot be ruled out, do not use the instrument.

## Accessories

- Use only the specified accessories (included in the scope of delivery or listed as options) with the instrument.
- Carefully and completely read and adhere to the product documentation for optional accessories. Retain these documents for future reference.

## Handling

- Use the instrument in undamaged condition only. Inspect the instrument before use. Pay particular attention to damage, interrupted insulation or kinked cables. Damaged components must be replaced immediately.
- Accessories and cables may only be used as long as they're fully intact. Inspect accessories and all cables before use. Pay particular attention to damage, interrupted insulation or kinked cables.
- If the instrument or its accessories don't function flawlessly, permanently remove the instrument/accessories from operation and secure them against inadvertent use.
- If the instrument or accessories are damaged during use, for example if they're dropped, permanently remove the instrument/accessories from operation and secure them against inadvertent use.
- The instrument and the accessories may only be used for the tests/measurements described in the documentation for the instrument.
- Neither the integrated voltage measuring function nor the mains connection test may be used to test systems or system components for the absence of voltage. Testing for the absence of voltage is only permissible with a suitable voltage tester or voltage measuring system which fulfills the requirements specified in DIN EN 61243.

## Operating Conditions

- Do not use the instrument and its accessories after long periods of storage under unfavorable conditions (e.g. humidity, dust or extreme temperature).
- Do not use the instrument and its accessories after extraordinary stressing due to transport.
- The instrument must not be exposed to direct sunlight.
- Only use the instrument and its accessories within the limits of the specified technical data and conditions (ambient conditions, IP protection code, measuring category etc.).
- Do not use the instrument in potentially explosive atmospheres.

## Rechargeable Batteries

- When using the charger, only the battery pack (Z502H) may be inserted in the device.
- Do not use the instrument while charging the battery pack (Z502H).
- Do not use the test instrument if the battery compartment lid has been removed. Touch contact with dangerous voltage is otherwise possible.
- The battery pack (Z502H) may only be charged in undamaged condition. Inspect the battery pack (Z502H) before use. Pay particular attention to leaky and damaged batteries.

## Fuses

- The instrument is equipped with fuses. The instrument may only be used as long as the fuses are in flawless condition. Defective fuses must be replaced. See detailed operating instructions.

## Measurement Cables and Establishing Contact

- Plugging in the measurement cables must not necessitate any undue force.
- Never touch conductive ends (e.g. of test probes).
- Fully unroll all measurement cables before starting a test/measurement. Never perform a test/measurement with the measurement cable rolled up.
- Avoid short circuits due to incorrectly connected measurement cables.
- Ensure that alligator clips, test probes or Kelvin probes make good contact.

## Data Security

- Always create a backup copy of your measurement data.
- Observe and comply with the respectively applicable national data protection regulations. Use the corresponding functions provided by the test instrument such as access protection, as well as other appropriate measures.

## 2 Applications

Please read this important information!

### 2.1 Intended Use / Use for Intended Purpose

Measuring and test instruments from the PROFITEST MASTER series include:

- PROFITEST MBASE+ (M520S)
- PROFITEST MXTRA (M522P)
- PROFITEST MTECH+ (M522R)
- PROFITEST MPRO (M520N)

The test instruments are used to test the effectiveness of protective measures at stationary electrical systems in accordance with IEC 60364-6, EN 50110-1 and other country-specific standards. They can also be used for the testing of electric charging stations per EN 61851-1 (DIN VDE 0122-1), and for earth measurements. The test instruments include pre-programmed test sequences for increased working convenience and user-defined test sequences can also be programmed as an option.

The test instruments are especially well suited for testing electrical systems during setup, initial startup, periodic testing and troubleshooting.

The applications range of the test instruments covers all alternating and 3-phase current systems with nominal voltages of 230/400 V (300/500 V) and nominal frequencies of 16⅔, 50, 60, 200 and 400 Hz.

A system structure is set up in the test instrument and measured values are assigned to the objects. Completed tests and measured values can be saved and documented in a measurement and test report.

Safety of the operator, as well as that of the test instrument, is only assured when it's used for its intended purpose.

### 2.2 Use for Other than Intended Purpose

Using the test instrument for any purposes other than those described in these operating instructions, or in the test instrument's condensed operating instructions, is contrary to use for intended purpose.

### 2.3 Liability and Guarantee

Gossen Metrawatt GmbH assumes no liability for property damage, personal injury or consequential damage resulting from improper or incorrect use of the product, in particular due to failure to observe the product documentation. Furthermore, all guarantee claims are rendered null and void in such cases.

Nor does Gossen Metrawatt GmbH accept any liability for data loss.

### 2.4 Opening the Instrument / Repairs

In order to ensure flawless, safe operation and to assure that the guarantee isn't rendered null and void, the test instrument may only be opened by authorized, trained personnel. Even original replacement parts may only be installed by authorized, trained personnel.

Unauthorized modification of the test instrument is prohibited.

If it can be ascertained that the test instrument has been opened by unauthorized personnel, no guarantee claims can be honored by the manufacturer with regard to personal safety, measuring accuracy, compliance with applicable safety measures or any consequential damages.

If the guarantee seal is damaged or removed, all guarantee claims are rendered null and void.

## 2.5 Scope of Functions

PROFITEST ... (Article Number)	MBASE+ (M520S)	MPRO (M520N)	MTECH+ (M522R)	MXTRA (M522P)
<b>Testing of Residual Current Devices (RCDs)</b>				
U <sub>T</sub> measurement without tripping the RCD	✓	✓	✓	✓
Tripping time measurement	✓	✓	✓	✓
Measurement of tripping current I <sub>T</sub>	✓	✓	✓	✓
Selective, SRCDs, PRCs, type G/R	✓	✓	✓	✓
AC/DC sensitive RCDs, types B and B+	—	—	✓	✓
Testing of insulation monitoring devices (IMDs)	—	—	—	✓
Testing of residual current monitoring devices (RCMs)	—	—	—	✓
Testing for N-PE reversal	✓	✓	✓	✓
<b>Measurement of Loop Impedance Z<sub>L-PE</sub> / Z<sub>L-N</sub></b>				
Fuse table for systems without RCDs	✓	✓	✓	✓
Without tripping the RCD, fuse table	—	—	✓	✓
15 mA measurement <sup>1)</sup>	✓	✓	✓	✓
<b>Earthing resistance R<sub>E</sub> (mains operation)</b>				
I/U measuring method (2/3-wire measuring method via measuring adapter: 2-pole/2-pole + probe)	✓	✓	✓	✓
<b>Earthing resistance R<sub>E</sub> (battery operation)</b>				
3 or 4-wire measuring method via PRO-RE adapter	—	✓	—	✓
Soil resistivity rE (battery operation) (4-wire measuring method via PRO-RE adapter)	—	✓	—	✓
<b>Selective earthing resistance R<sub>E</sub> (mains operation)</b>				
with 2-pole adapter, probe, earth electrode and current clamp sensor (3-wire measuring method)	✓	✓	✓	✓
<b>Selective earthing resistance R<sub>E</sub> (battery operation)</b>				
with probe, earth electrode and current clamp sensor (4-wire measuring method via PRO-RE adapter and current clamp sensor)	—	✓	—	✓
Earth loop resistance RELOOP (battery operation)	—	✓	—	✓
with 2 clamps (current clamp sensor direct and current clamp transformer via PRO-RE/2 adapter)	—	✓	—	✓
<b>Measurement of equipotential bonding R<sub>LO</sub></b>				
Automatic polarity reversal	✓	✓	✓	✓
<b>Insulation resistance R<sub>INS</sub></b>				
Variable or rising test voltage (ramp)	✓	✓	✓	✓
<b>Voltage U<sub>L-N</sub> / U<sub>L-PE</sub> / U<sub>N-PE</sub> / f</b>				
✓	✓	✓	✓	✓
<b>Special Measurements</b>				
I <sub>L</sub> , I <sub>AMP</sub> current measurement with clamp	✓	✓	✓	✓
Phase sequence	✓	✓	✓	✓
Earth leakage resistance R <sub>E(INS)</sub>	✓	✓	✓	✓
Voltage drop (ΔU)	✓	✓	✓	✓
Standing-surface insulation Z <sub>ST</sub>	✓	✓	✓	✓
Meter startup (kWh test)	✓	✓	✓	✓
Leakage current with PRO-AB (IL) adapter	—	—	—	✓
Residual voltage test (U <sub>res</sub> )	—	—	—	✓
Intelligent ramp (ta + ΔI)	—	—	—	✓
Electric vehicles at charging stations (IEC 61851-1)	—	—	✓	✓
Documentation of fault simulations at PRCs with the PROFITEST PRC adapter	—	—	—	✓
<b>Features</b>				
Selectable user interface language <sup>2)</sup>	✓	✓	✓	✓
Memory (database for up to 50,000 objects)	✓	✓	✓	✓
Automatic test sequence function	✓	✓	✓	✓
RS 232 port for RFID/barcode reader	✓	✓	✓	✓
USB port for data transmission	✓	✓	✓	✓
ETC PC database and report generating software	✓	✓	✓	✓
Measuring category: CAT III 600 V / CAT IV 300 V	✓	✓	✓	✓
DAKs calibration certificate	✓	✓	✓	✓

<sup>1)</sup> The so-called live measurement is only advisable if there's no bias current within the system. Only suitable for motor protection switches with small nominal current values.

<sup>2)</sup> Currently available languages D, GB, I, F, E, P, NL, S, N, FIN, CZ, PL

### 3 Documentation

This documentation describes several test instrument. As a result, features and functions may be described which do not apply to your instrument. Furthermore, illustrations may differ from your instrument.



#### Note

These operating instructions describe a test instrument with software/firmware version 1.16.20.

#### List of Abbreviations and their Meanings

RCCBs (residual current circuit breakers / RCDs):

$I_{\Delta}$	Tripping current
$I_{\Delta N}$	Nominal residual current
$I_{F\blacktriangleleft}$	Rising test current (residual current)
PRCD	Portable residual current device
PRCD-S:	with protective conductor detection and monitoring
PRCD-K:	with undervoltage trigger and protective conductor monitoring
RCD- <b>S</b>	Selective RCCB
$R_E$	Calculated earthing or earth electrode loop resistance
SRCD	Socket residual current device (permanently installed)
$t_a$	Time to trip / breaking time
$U_{I\Delta}$	Touch voltage at moment of tripping
$U_{I\Delta N}$	Touch voltage relative to nominal residual current $I_{\Delta N}$
$U_L$	Touch voltage limit value

Overcurrent protective devices:

$I_{SC}$	Calculated short-circuit current (at nominal voltage)
$Z_{L-N}$	Supply impedance
$Z_{L-PE}$	Loop impedance
Earthing:	
$R_B$	Operational earth resistance
$R_E$	Measured earthing resistance
$R_{ELoop}$	Earth electrode loop resistance

Low-value resistance at protective, earthing and bonding conductors:

$R_{LO+}$	Equipotential bonding conductor resistance (+ pole to PE)
$R_{LO-}$	Equipotential bonding conductor resistance (- pole to PE)

Insulation:

$R_{E(INS)}$	Earth leakage resistance (DIN 51953)
$R_{INS}$	Insulation resistance
$R_{ST}$	Standing surface insulation resistance
$Z_{ST}$	Standing surface insulation impedance

Current:

$I_A$	Breaking current
$I_L$	Leakage current (measured with current clamp transformer)
$I_M$	Measuring current
$I_N$	Nominal current
$I_P$	Test current

Voltage:

$f$	Line voltage frequency
-----	------------------------

$f_N$	Nominal voltage rated frequency
$\Delta U$	Voltage drop as %
$U$	Voltage measured at the test probes during and after insulation measurement $R_{INS}$
$U_{Batt}$	(Rechargeable) battery voltage
$U_E$	Earth electrode voltage
$U_{INS}$	When measuring $R_{INS}$ : test voltage for ramp function: tripping or breakdown voltage
$U_{L-L}$	Voltage between two phase conductors
$U_{L-N}$	Voltage between L and N
$U_{L-PE}$	Voltage between L and PE
$U_N$	Nominal line voltage
$U_{3-}$	Highest measured voltage during determination of phase sequence
$U_{S-PE}$	Voltage between probe and PE
$U_Y$	Phase-to-earth voltage

### 4 Getting Started

1. Read and adhere to the product documentation. In particular observe all safety information in the documentation, on the instrument and on the packaging.  
See:
  - section 1, “Safety Instructions”, on page 4
  - section 2, “Applications”, on page 5
  - section 3, “Documentation”, on page 6
2. Familiarize yourself with the test instrument.  
See:
  - section 5, “The Instrument”, on page 7
  - section 6, “Operating and Display Elements”, on page 16
  - section 7, “Operation”, on page 26
3. Enter the basic settings.  
See section 8, “Instrument Settings”, on page 27.
4. Optional but recommended: Create a database in the test instrument. See section 9, “Database”, on page 31.
5. Read the basic information provided in section 10, “General Information on Measurements”, on page 36.
6. Perform measurements.  
Refer to individual measurements or test sequences (automatic sequences):
  - section 11, “Measuring Voltage and Frequency”, on page 41
  - section 12, “Testing RCDs”, on page 43
  - section 13, “Testing of Breaking Requirements for Overcurrent Protective Devices, Measurement of Loop Impedance and Determination of Short-Circuit Current ( $Z_{L-PE}$  and  $I_{SC}$  Functions)”, on page 54
  - section 14, “Measuring Supply Impedance ( $Z_{L-N}$  Function)”, on page 57
  - section 15, “Earthing Resistance Measurement (Function  $R_E$ )”, on page 59
  - section 16, “Measurement of Insulation Resistance”, on page 73
  - section 17, “Measuring Low-Value Resistance of up to 200  $\Omega$  (Protective Conductor and Equipotential Bonding Conductor)”, on page 77
  - section 18, “Measurement with Accessory Sensors”, on page 80
  - section 19, “Special Functions – EXTRA Switch Position”, on page 81
  - section 20, “Test Sequences (Automatic Test Sequences) – AUTO Function”, on page 95

Further interesting information: section 21, “Maintenance”, on page 97.

## 5 The Instrument

### 5.1 Scope of Delivery

Standard scope of delivery for PROFITEST MASTER series:

1 Test instrument	1 Compact battery pack (Z502H)
1 Earthing contact plug insert, country-specific (PRO-SCHUKO / GTZ3228000R0001)	1 Charger (Z502R)
1 2-pole measuring adapter and cable for expansion into a 3-pole adapter (PRO-A3-II / Z501O)	1 DAkkS calibration certificate
2 Alligator clips	1 Operating Instructions (this document)
1 USB cable	
1 Neck strap	1 ETC software*

\*\* Download from Internet

### 5.2 Optional Accessories (excerpt)

A complete overview of optional accessories including detailed information can be found in the data sheet for the test instrument.

The most important accessories are listed here:

- Barcode Profiscanner RS232 (Z502F) (barcode reader and scanner for RS 232 connection to the test instrument for identifying systems, electrical circuits and operating equipment.)
- PRO-HB (Z501V) Holder for test probes and measuring adapter
- Country-specific plug inserts
  - PRO-GB/USA (Z503B)
  - PRO-CH (GTZ3225000R0001)
- Plug inserts for PE and other similar measurements
  - PRO-RLO-II (Z501P) (cable length: 10m)
  - PRO-RLO 20 (Z505F) (cable length: 20m)
  - PRO-RLO 50 (Z505G) (cable length: 50m)
- PRO-AB (Z502S) (leakage current measuring adapter for PROFITEST MXTRA)
- PROFITEST PRCD (M512R) (test adapter for testing portable safety switches (types PRCD-K and PRCD-S) with the help of the PROFITEST MXTRA)
- PROFITEST EMOBILITY (M513R) (adapter for standards-compliant testing of single and 3-phase, mode 2 and 3 charging cables with simulation of faults)
- E-SET BASIC (Z593A) (basic earth measurement accessories)
- E-SET PROFESSIONAL (Z592Z) (extensive earth measurement accessories)

### 5.3 Meanings of Symbols on the Instrument



Warning concerning a point of danger (attention, observe documentation!)



Protection category II device



Charging socket for extra-low direct voltage (for Z502R charger)



The device and its batteries may not be disposed of with household trash. Further information is included in the operating instructions.



Indicates EC conformity



If the guarantee seal is damaged or removed, all guarantee claims are rendered null and void.



The special technical knowledge of qualified personnel is required for electrical installation or repair.

Calibration seal (blue seal):

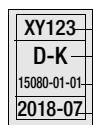

Consecutive number

D-K Deutsche Akkreditierungsstelle GmbH – calibration lab

15080-01-01 Registration number

2018-07 Date of calibration (year – month)

CAT III  
600 V

Measuring category

CAT IV  
300 V

## 5.4 Instrument Overview

### Test Instrument and Adapter

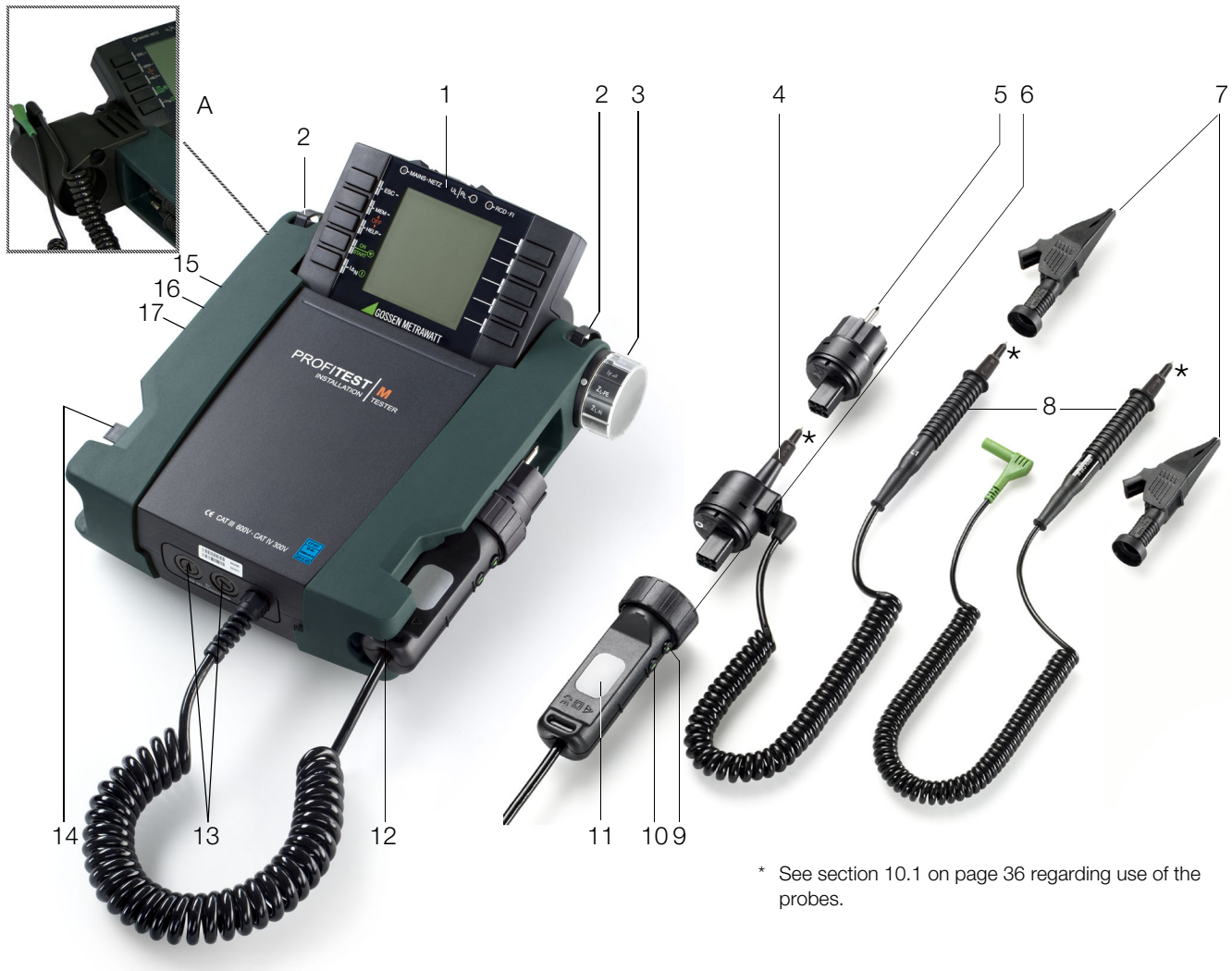

Connector Sockets for Current Clamp Sensor, Probe and PRO-AB Leakage Current Measuring Adapter

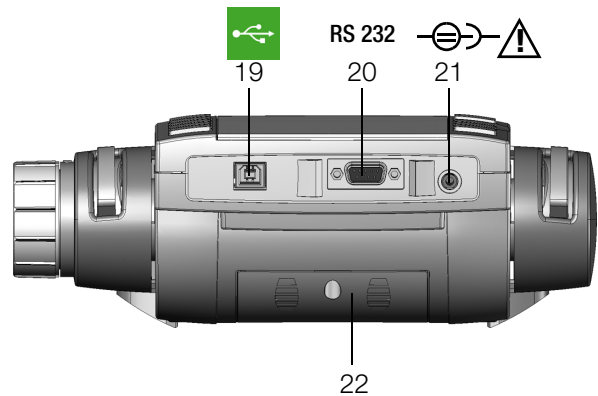
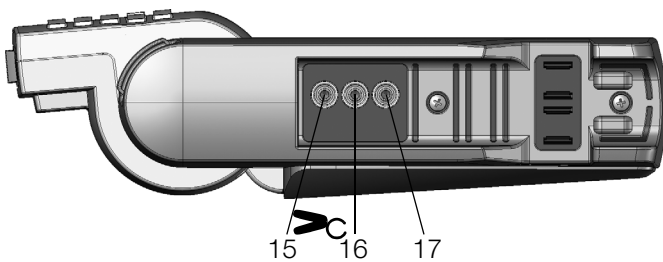

#### Test Instrument and Adapter:

- 1 Control panel with keys and display screen
- 2 Eyelets for attaching the neck strap
- 3 Rotary selector switch
- 4 Measuring adapter (2-pole)
- 5 Plug insert (country-specific)
- 6 Test plug (with retaining ring)
- 7 Alligator clip (plug-on)
- 8 Test probes
- 9 **ON/START** ▼ key \*
- 10 I ΔN/compens./ZOFFSET key
- 11 Contact surfaces for finger contact
- 12 Test plug holder
- 13 Fuses
- 14 Holders for test probes (8)

#### Connections for Current Clamp, Probe, PRO-AB Leakage Current Measuring Adapter:

- 15 Current clamp connection 1
- 16 Current clamp connection 2
- 17 Probe socket

#### Interfaces, Charger Connection:

- 19 USB slave for connection to a PC
- 20 RS 232 port for connecting barcode or RFID reader
- 21 Socket for Z502R charger
- 22 Battery compartment lid (compartment for batteries and spare fuses)

\* Can only be switched on with the key on the instrument

#### Accessories:

- A PRO-HB (Z501V) test probe and measuring adapter holder – can be purchased separately



### (1) Control Panel – Display Panel

See section 6.1, “Control Panel”, on page 16.

See section 6.2, “Display”, on page 16.

### (2) Eyelets for the Neck Strap

The included neck strap can be attached at the right and left hand sides of the instrument. You can hang the instrument from your neck and keep both hands free for measurement.

### (3) Rotary Selector Switch

The following basic functions can be selected with the rotary switch:

SETUP /  $I_{\Delta N}$  /  $I_F$  /  $Z_{L-PE}$  /  $Z_{L-N}$  /  $R_E$  /  $R_{LO}$  /  $R_{INS}$  / U / SENSOR / EXTRA / AUTO

The various basic functions are selected by turning the function selector switch while the instrument is switched on.

### (4) Measuring Adapter



#### Attention!

The measuring adapter (2-pole) may only be used together with the test instrument's test plug. Use for other purposes is prohibited!

The plug-on measuring adapter (2-pole) with the two test probes is used for measurements in systems without earthing contact outlets, e.g. at permanent installations, distribution cabinets and all three-phase outlets, as well as for insulation resistance and low-value resistance measurements.

The 2-pole measuring adapter can be expanded to three poles for phase sequence testing with the included measurement cable (test probe).

### (5) Plug Insert (country-specific)



#### Attention!

The plug insert may only be used together with the test instrument's test plug. Use for other purposes is prohibited!

After the plug insert has been attached, the instrument can be directly connected to earthing contact outlets. There's no need to concern yourself with poling at the plug. The instrument detects the positions of phase conductor L and neutral conductor N and automatically reverses polarity if necessary.

The instrument automatically determines whether or not both protective contacts in the earthing contact outlet are connected to one another, as well as to the system protective conductor, for all types of protective conductor measurements when the plug insert is attached to the test plug.

### (6) Test Plug

The various country specific plug inserts (e.g. protective contact plug insert for Germany or SEV plug insert for Switzerland) or the measuring adapter (2-pole) are attached to the test plug and secured with a threaded connector.

The controls on the test plug are subject to interference suppression filtering. This may lead to slightly delayed responses as opposed to controls located directly on the instrument.

### (7) Alligator Clip (plug-on)

### (8) Test Probes

The test probes comprise the second (permanently attached) and third (plug-on) poles of the measuring adapter. A coil cable connects them to the plug-on portion of the measuring adapter.

### (9) ON/Start ▼ Key

The measuring sequence for the function selected in the menu is started by pressing this key, either on the test plug or at the control panel. Exception: If the instrument is switched off, it can only be switched on by pressing the key at the control panel.



This key has the same function as the ▼ key on the test plug.

### (10) $I_{\Delta N}$ / I Key (at the control panel)

The following sequences are triggered by pressing this key, either on the test plug or at the control panel:



- Starts the tripping test after measurement of touch voltage for RCCB testing ( $I_{\Delta N}$ ).
- Measurement of **ROFFSET** is started in the **R<sub>LO</sub> / Z<sub>L-N</sub>** function.
- Semiautomatic polarity reversal (see section 10.9)

### (11) Contact Surfaces

The contact surfaces are located at both sides of the test plug. When the contact plug is grasped in the hand, contact is automatically made with these surfaces. The contact surfaces are electrically isolated from the terminals and from the measuring circuit.

In the event a potential difference of greater than 25 V between protective conductor terminal PE and the contact surface, PE is displayed. See “LED Indications, Mains Connections and Potential Differences” on page 17.

### (12) Test Plug Holder

The test plug with attached plug insert can be reliably secured to the instrument with the rubberized holder.

### (13) Fuses

The two fuses protect the device in case of overload. Phase conductor L and neutral conductor N are fused individually. If a fuse is defective, and if an attempt is made to perform a measurement which uses the circuit protected by this fuse, a corresponding message appears at the display panel.

See section 21.2, “Fuse Replacement”, on page 97.

### (14) Holders for Test Probes (8)

### (15/16) Current Clamp Connector

Only the current clamp transformers offered as accessories may be connected to these sockets.

### (17) Probe Connector Socket

The probe connector socket is required for the measurement of probe voltage  $U_{S-PE}$ , earth electrode voltage  $U_E$ , earthing resistance  $R_E$  and standing surface insulation resistance.

It can be used for the measurement of touch voltage during RCD testing. The probe is connected with a 4 mm contact-protected plug.

The instrument determines whether or not the probe has been properly set and displays results at the display panel.

### (19) USB Port

The USB port allows for the exchange of data between the test instrument and a PC.

### (20) RS 232 Port

This port allows for data entry by means of a barcode scanner or an RFID reader.

### (21) Charging Socket

Only the **Z502R** charger for charging batteries inside the test instrument may be connected to this socket.

### (22) Battery Compartment Lid – Replacement Fuses



#### Attention!

Before removing the lid is removed, the instrument must be disconnected from the measuring circuit at all poles!

The compartment under the lid accommodates the rechargeable battery pack (Z502H), or commercially available rechargeable batteries or regular batteries.

Two replacement fuses are also located under the battery compartment lid.

## 5.5 Technical Data

### Nominal Ranges of Use

Voltage $U_N$	120 V (108 V ... 132 V)
	230 V (196 V ... 253 V)
	400 V (340 V ... 440 V)
Frequency $f_N$	16% Hz (15.4 V ... 18 Hz)
	50 Hz (49.5 V ... 50.5 Hz)
	60 Hz (59.4 V ... 60.6 Hz)
	200 Hz (190 V ... 210 Hz)
	400 Hz (380 V ... 420 Hz)
Overall voltage range	65 V ... 550 V
Overall frequency range	15.4 Hz ... 420 Hz
Line voltage	Sinusoidal
Temperature range	0 °C ... + 40 °C
Battery voltage	8 V ... 12 V
Supply impedance angle	Corresponds to $\cos\varphi = 1 \dots 0.95$
Probe resistance	< 50 k $\Omega$

### Reference Conditions

Line voltage	230 V $\pm$ 0.1%
Line frequency	50 Hz $\pm$ 0.1%
Measured qty. frequency	45 Hz ... 65 Hz
Measured qty. waveform	Sine (deviation between effective and rectified value $\leq$ 0.1%)

Supply impedance angle	$\cos\varphi = 1$
Probe resistance	$\leq 10\ \Omega$
Supply voltage	12 V $\pm$ 0.5 V
Ambient temperature	+ 23° C $\pm$ 2 K
Relative humidity	40% ... 60%
Finger contact	For testing potential difference to ground potential

Standing surface insulation	Purely ohmic
-----------------------------	--------------

### Power Supply

Batteries	8 each AA 1.5 V We recommend exclusive use of the included rechargeable battery pack (2000 mAh, Z502H).
Number of measurements (standard setup with illumination)	
– For $R_{INS}$	1 measurement – 25 s pause: approx. 1100 measurements
– For $R_{LO}$	Auto polarity reversal / 1 $\Omega$ (1 measuring cycle) – 25 s pause: approx. 1000 (Z502O) measurements
Battery test	Symbolic display of rechargeable battery voltage <b>BAT</b> 
Battery-saving circuit	Display illumination can be switched off. The test instrument is switched off automatically after the last key operation. The user can select the desired on-time.
Safety shutdown	If supply voltage is too low, the instrument is switched off, or cannot be switched on.
Recharging socket	Inserted rechargeable batteries can be recharged directly by connecting a charger to the recharging socket: Z502R charger
Charging time	Z502R charger: approx. 2 hours *

\* Maximum charging time with fully depleted batteries.  
A timer in the charger limits charging time to no more than 4 hours.

### Overload Capacity

$R_{ISO}$	1200 V continuous
$U_{L-PE}, U_{L-N}$	600 V continuous
RCD, $R_E, R_F$	440 V continuous
$Z_{L-PE}, Z_{L-N}$	550 V (Limits the number of measurements and pause duration. If overload occurs, the instrument is switched off by means of a thermostatic switch.)
$R_{LO}$	Electronic protection prevents switching on if interference voltage is present.
Protection with fine-wire fuses	FF 3.15 A 10 s, Fuses blow at > 5 A –

### Electrical Safety

Protection class	II
Nominal voltage	230/400 V (300/500 V)
Test voltage	3.7 kV, 50 Hz
Measuring category	CAT III 600 V or CAT IV 300 V
Pollution degree	2
Fuses	
L and N terminals	1 G fuse-link ea. FF 3.15/500G 6.3 $\times$ 32 mm

### Electromagnetic Compatibility (EMC)

Product standard	EN 61326-1
------------------	------------

Interference emission		Class
EN 55022		A
Interference immunity	Test value	Feature
EN 61000-4-2	Contact/atmos. – 4 kV/8 kV	
EN 61000-4-3	10 V/m	
EN 61000-4-4	Mains connection – 2 kV	
EN 61000-4-5	Mains connection – 1 kV	
EN 61000-4-6	Mains connection – 3 V	
EN 61000-4-11	0.5 periods / 100%	

### Ambient Conditions

Accuracy	0 ... + 40 °C
Operation	–5 ... + 50 °C
Storage	–20 ... + 60 °C (without batteries)
Relative humidity	Max. 75%, no condensation allowed
Elevation	Max. 2000 m







### Mechanical Design

Display	Multiple display with dot matrix, 128 $\times$ 128 pixels
Dimensions	W $\times$ L $\times$ H = 260 $\times$ 330 $\times$ 90 mm
Weight	Approx. 2.7 kg with batteries
Protection	Housing: IP 40, test probe: IP 20 per EN 60529

### Data Interfaces

Type	USB for PC connection
Type	RS 232 for barcode and RFID readers

## 5.6 Characteristic Values for PROFITEST MTECH+ and PROFITEST MBASE+

Function	Measured Quantity	Display Range	Resolution	Input Impedance / Test Current	Measuring Range	Nominal Values	Measuring Uncertainty	Intrinsic Uncertainty	Connections						
									Plug Insert <sup>1</sup>	2-Pole Adapter	3-Pole Adapter	Probe	Clamp Meters WZ12C	Z3512A	MFLEX P300
U	U <sub>L-PE</sub> U <sub>N-PE</sub>	0 ... 99.9 V 100 ... 600 V	0.1 V 1 V	5 MΩ	0.3 ... 600 V <sup>1</sup>	U <sub>N</sub> = 120, 230, 400, 500 V  f <sub>N</sub> = 16.7, 50, 60, 200, 400 Hz	±(12% rdg.l+5d) ±(12% rdg.l+1d)	±(1% rdg.l+5d) ±(1% rdg.l+1d)	•	•	•				
	f	15.0 ... 99.9 Hz 100 ... 999 Hz	0.1 Hz 1 Hz		DC 15.4 ... 420 Hz		±(0.2% rdg.l+1d)	±(0.1% rdg.l+1d)							
	U <sub>3 AC</sub>	0 V ... 99.9 V 100 V ... 600 V	0.1 V 1 V				0.3 V ... 600 V	±(13% rdg.l+5d) ±(13% rdg.l+1d)	±(12% rdg.l+5d) ±(12% rdg.l+1d)			•			
	U <sub>Probe</sub>	0 ... 99.9 V 100 ... 600 V	0.1 V 1 V				1.0 V ... 600 V	±(12% rdg.l+5d) ±(12% rdg.l+1d)	±(1% rdg.l+5d) ±(1% rdg.l+1d)				•		
	U <sub>L-N</sub>	0 ... 99.9 V 100 ... 600 V	0.1 V 1 V				1.0 ... 600 V <sup>1</sup>	±(13% rdg.l+5d) ±(13% rdg.l+1d)	±(12% rdg.l+5d) ±(12% rdg.l+1d)	•		•			
I <sub>ΔN</sub>  I <sub>F</sub>	U <sub>IΔN</sub>	0 ... 70.0 V	0.1 V	0.3 × I <sub>ΔN</sub>	5 V ... 70 V	U <sub>N</sub> = 120 V, 230 V, 400 V <sup>2</sup>  f <sub>N</sub> = 50 Hz, 60 Hz  U <sub>L</sub> = 25 V, 50 V  I <sub>ΔN</sub> = 6 mA, 10 mA, 30 mA, 100 mA, 300 mA, 500 mA <sup>2</sup>	+110% rdg.l+1d	+1% rdg.l-1d ... +19% rdg.l+1d							
	R <sub>E</sub>	10 Ω ... 999 Ω 1.00 kΩ ... 6.51 kΩ	1 Ω 0.01 kΩ	I <sub>ΔN</sub> = 10 mA × 1.05	Calculated value from R <sub>E</sub> = U <sub>IΔN</sub> / I <sub>ΔN</sub>		U <sub>IΔN</sub> = 10 mA × 1.05	U <sub>IΔN</sub> = 10 mA × 1.05							
		3 Ω ... 999 Ω 1 kΩ ... 2.17 kΩ	1 Ω 0.01 kΩ	I <sub>ΔN</sub> = 30 mA × 1.05											
		1 Ω ... 651 Ω	1 Ω	I <sub>ΔN</sub> = 100 mA × 1.05											
		0.3 Ω ... 99.9 Ω 100 Ω ... 217 Ω	0.1 Ω 1 Ω	I <sub>ΔN</sub> = 300 mA × 1.05											
		0.2 Ω ... 9.9 Ω 10 Ω ... 130 Ω	0.1 Ω 1 Ω	I <sub>ΔN</sub> = 500 mA × 1.05											
	I <sub>F</sub> (I <sub>ΔN</sub> = 6 mA)	1.8 ... 7.8 mA	0.1 mA	1.8 ... 7.8 mA	1.8 ... 7.8 mA										
	I <sub>F</sub> (I <sub>ΔN</sub> = 10 mA)	3.0 ... 13.0 mA	0.1 mA	3.0 ... 13.0 mA	3.0 ... 13.0 mA										
	I <sub>F</sub> (I <sub>ΔN</sub> = 30 mA)	9.0 ... 39.0 mA	0.1 mA	9.0 ... 39.0 mA	9.0 ... 39.0 mA										
	I <sub>F</sub> (I <sub>ΔN</sub> = 100 mA)	30 ... 130 mA	1 mA	30 ... 130 mA	30 ... 130 mA										
	I <sub>F</sub> (I <sub>ΔN</sub> = 300 mA)	90 ... 390 mA	1 mA	90 ... 390 mA	90 ... 390 mA										
	I <sub>F</sub> (I <sub>ΔN</sub> = 500 mA)	150 ... 650 mA	1 mA	150 ... 650 mA	150 ... 650 mA										
	U <sub>IΔ</sub> / U <sub>L</sub> = 25 V	0 ... 25.0 V	0.1 V	Same as I <sub>Δ</sub>	0 ... 25.0 V										
U <sub>IΔ</sub> / U <sub>L</sub> = 50 V	0 ... 50.0 V	0.1 V	Same as I <sub>Δ</sub>	0 ... 50.0 V											
t <sub>A</sub> (I <sub>ΔN</sub> × 1)	0 ... 1000 ms	1 ms	6 ... 500 mA	0 ... 1000 ms											
t <sub>A</sub> (I <sub>ΔN</sub> × 2)	0 ... 1000 ms	1 ms	2 × 6 mA ... 2 × 500 mA	0 ... 1000 ms											
t <sub>A</sub> (I <sub>ΔN</sub> × 5)	0 ... 40 ms	1 ms	5 × 6 mA ... 5 × 300 mA	0 ... 40 ms											
Z <sub>L-PE</sub>  Z <sub>L-N</sub>	Z <sub>L-PE</sub> (  ) Z <sub>L-N</sub>	0 mΩ ... 999 mΩ 1.00 Ω ... 9.99 Ω	1 mΩ 0.01 Ω 0.1 Ω	1.3 A AC ... 3.7 A AC 0.5 A DC, 1.25 A DC <sup>8</sup>	0.15 Ω ... 0.49 Ω 0.50 Ω ... 0.99 Ω 1.00 Ω ... 9.99 Ω	U <sub>N</sub> = 120 V, 230 V, 400 V, 500 V <sup>1</sup> f <sub>N</sub> = 16.7 Hz, 50 Hz, 60 Hz	±(110% rdg.l+30d) ±(110% rdg.l+30d) ±(15% rdg.l+3d)	±(5% rdg.l+30d) ±(4% rdg.l+30d) ±(3% rdg.l+3d)							
	Z <sub>L-PE</sub> (  ) + DC <sup>8</sup>	0 mΩ ... 999 mΩ 1.00 Ω ... 9.99 Ω 10.0 Ω ... 29.9 Ω			0.25 Ω ... 0.99 Ω 1.00 Ω ... 9.99 Ω		U <sub>N</sub> = 120, 230 V f <sub>N</sub> = 50, 60 Hz	±(118% rdg.l+30d) ±(110% rdg.l+3d)	±(6% rdg.l+50d) ±(4% rdg.l+3d)						
	I <sub>SC</sub> (Z <sub>L-PE</sub>  )	0 to 9.9 A 10 ... 999 A	0.1 A 1 A 10 A 100 A		120 (108 ... 132) V 230 (196 ... 253) V 400 (340 ... 440) V 500 (450 ... 550) V			Value calculated from Z <sub>L-PE</sub>				•	•		
	Z <sub>L-PE</sub> (  ) + DC <sup>8</sup>	0.6 Ω ... 9.9 Ω	0.1 Ω		Display range only										
	Z <sub>L-PE</sub> (15 mA)	10.0 Ω ... 99.9 Ω 100 Ω ... 999 Ω	0.1 Ω 1 Ω				10.0 Ω ... 99.9 Ω 100 Ω ... 999 Ω	U <sub>N</sub> = 120, 230 V f <sub>N</sub> = 16.7 <sup>8</sup> , 50, 60 Hz	±(110% rdg.l+10d) ±(8% rdg.l+2d)	±(2% rdg.l+2d) ±(1% rdg.l+1d)					
I <sub>SC</sub> (15 mA)	100 ... 999 mA 0.00 ... 9.99 A 10.0 ... 99.9 A	1 mA 0.01 A 0.1 A	15 mA AC	Calculated value depending on U <sub>N</sub> and Z <sub>L-PE</sub> : I <sub>SC</sub> = U <sub>N</sub> / 10 Ω ... 1000 Ω		Value calculated from Z <sub>L-PE</sub> (15 mA): I <sub>SC</sub> = U <sub>N</sub> / Z <sub>L-PE</sub> (15 mA)									
R <sub>E</sub>	R <sub>E</sub> (with probe)	0 mΩ ... 999 mΩ 1.00 Ω ... 9.99 Ω	1 mΩ 0.01 Ω	1.3 ... 3.7 A AC 1.3 ... 3.7 A AC	0.15 Ω ... 0.49 Ω 0.50 Ω ... 0.99 Ω	U <sub>N</sub> = 120, 230 V U <sub>N</sub> = 400 V <sup>1</sup> f <sub>N</sub> = 50, 60 Hz	±(110% rdg.l+30d) ±(110% rdg.l+30d)	±(5% rdg.l+30d) ±(4% rdg.l+30d)							
	[R <sub>E</sub> (without probe) values same as Z <sub>L-PE</sub> ]	10.0 Ω ... 99.9 Ω 100 Ω ... 999 Ω 1 kΩ ... 9.99 kΩ	0.1 Ω 1 Ω 0.01 kΩ	1.3 ... 3.7 A AC 400 mA AC 40 mA AC 4 mA AC	1.0 Ω ... 9.99 Ω 10 Ω ... 99.9 Ω 100 Ω ... 999 Ω 1 kΩ ... 9.99 kΩ		±(15% rdg.l+3d) ±(110% rdg.l+3d) ±(110% rdg.l+3d)	±(3% rdg.l+3d) ±(3% rdg.l+3d) ±(3% rdg.l+3d)							
	R <sub>E</sub> DC+  <sup>8</sup>	0 mΩ ... 999 mΩ 1.00 Ω ... 9.99 Ω 10.0 Ω ... 29.9 Ω	1 mΩ 0.01 Ω 0.1 Ω	1.3 ... 3.7 A AC 0.5, 1.25 A DC <sup>8</sup>	0.25 Ω ... 0.99 Ω 1.00 Ω ... 9.99 Ω		U <sub>N</sub> = 120, 230 V f <sub>N</sub> = 50, 60 Hz	±(118% rdg.l+30d) ±(110% rdg.l+3d)	±(6% rdg.l+50d) ±(4% rdg.l+3d)						
	U <sub>E</sub>	0 ... 253 V	1 V	—	Calculated value										
R <sub>E</sub> Sel Clamp	R <sub>E</sub>	0 Ω ... 999 Ω	1 mΩ ... 1 Ω	1.3 ... 2.7 A AC 0.5 / 1.25 A DC <sup>8</sup>	0.25 Ω ... 300 Ω <sup>4</sup>	See R <sub>E</sub>	±(20% rdg.l+20d)	±(15% rdg.l+20d)							
	R <sub>E</sub> DC+  <sup>8</sup>	0 Ω ... 999 Ω	1 mΩ ... 1 Ω			U <sub>N</sub> = 120, 230 V f <sub>N</sub> = 50, 60 Hz	±(22% rdg.l+20d)	±(15% rdg.l+20d)							
EXTRA	Z <sub>ST</sub>	10 kΩ ... 199 kΩ 200 kΩ ... 999 kΩ 1.00 MΩ ... 9.99 MΩ 10.0 MΩ ... 30.0 MΩ	1 kΩ 1 kΩ 0.01 MΩ 0.1 MΩ	2.3 mA at 230 V	10 kΩ ... 199 kΩ 200 kΩ ... 999 kΩ 1.00 MΩ ... 9.99 MΩ 10.0 MΩ ... 30.0 MΩ	U <sub>0</sub> = U <sub>L-N</sub>	±(20% rdg.l+2d)	±(10% rdg.l+3d)	•	•	•	•			

# PROFITEST MTECH+ and PROFITEST MBASE+

Function	Measured Quantity	Display Range	Resolution	Test Current	Measuring Range	Nominal Values	Measuring Uncertainty	Intrinsic Uncertainty	Connections								
									Plug. Insert <sup>1</sup>	2-Pole Adapter	3-Pole Adapter	Clamps / WZ12 C	Meas. Ranges Z3512 A	MFLEX P300	CP1100		
R <sub>ISO</sub>	R <sub>INS</sub> , R <sub>EINS</sub>	1 kΩ ... 999 kΩ 1.00 MΩ ... 9.99 MΩ 10.0 MΩ ... 49.9 MΩ	1 kΩ 10 kΩ 100 kΩ	I <sub>sc</sub> = 1.5 mA	50 kΩ ... 999 kΩ 1.00 MΩ ... 49.9 MΩ	U <sub>N</sub> = 50 V I <sub>N</sub> = 1 mA	KΩ range ±(5% rdg.l+10d) MΩ range ±(5% rdg.l+1d)	kΩ range ±(3% rdg.l+10d) MΩ range ±(3% rdg.l+1d)	•	•							
		1 kΩ ... 999 kΩ 1.00 MΩ ... 9.99 MΩ 10.0 MΩ ... 99.9 MΩ	1 kΩ 10 kΩ 100 kΩ		50 kΩ ... 999 kΩ 1.00 MΩ ... 99.9 MΩ	U <sub>N</sub> = 100 V I <sub>N</sub> = 1 mA											
		1 kΩ ... 999 kΩ 1.00 MΩ ... 9.99 MΩ 10.0 MΩ ... 99.9 MΩ 100 MΩ ... 200 MΩ	1 kΩ 10 kΩ 100 kΩ 1 MΩ		50 kΩ ... 999 kΩ 1.00 MΩ ... 200 MΩ	U <sub>N</sub> = 250 V I <sub>N</sub> = 1 mA											
		1 kΩ ... 999 kΩ 1.00 MΩ ... 9.99 MΩ 10.0 MΩ ... 99.9 MΩ 100 MΩ ... 500 MΩ	1 kΩ 10 kΩ 100 kΩ 1 MΩ		50 kΩ ... 999 kΩ 1.00 MΩ ... 499 MΩ	U <sub>N</sub> = 325 V, U <sub>N</sub> = 500 V, U <sub>N</sub> = 1000 V I <sub>N</sub> = 1 mA											
	U	10 ... 999 V 1.00 ... 1.19 kV	1 V 10 V	10 ... 1.19 kV		±(3% rdg.l+1d)	±(1.5% rdg.l+1d)										
R <sub>LO</sub>	R <sub>LO</sub>	0.00 Ω ... 9.99 Ω 10.0 Ω ... 99.9 Ω 100 Ω ... 199 Ω	0.01 Ω 0.1 Ω 1 Ω	I ≥ 200 mA DC I < 260 mA DC	0.10 Ω ... 5.99 Ω 6.00 Ω ... 99.9 Ω	U <sub>0</sub> = 4.5 V	±(4% rdg.l+2d)	±(2% rdg.l+2d)		•							
	ROFFSET	0.00 Ω ... 9.99 Ω	0.01 Ω	I ≥ 200 mA DC I < 260 mA DC	0.10 Ω ... 5.99 Ω 6.00 Ω ... 99.9 Ω												
				Transformation ratio <sup>3</sup>			5	5									
SEN- SOR 6, 7	I <sub>L/Amp</sub>	0.0 mA ... 99.9 mA 100 ... 999 mA 1.00 ... 9.99 A 10.0 ... 15.0 A	0.1 mA 1 mA 0.01 A 0.1 A	1 V/A	5 A ... 15 A	f <sub>N</sub> = 50, 60 Hz	±(13% rdg.l+5d)	±(5% rdg.l+4d)				I 15A					
		1.00 ... 9.99 A 10.0 ... 15.0 A	0.01 A 0.1 A				±(13% rdg.l+1d)	±(5% rdg.l+1d)									
		1.00 ... 9.99 A 10.0 ... 99.9 A 100 A ... 150 A	0.01 A 0.1 A 1 A	1 mV / A	5 ... 150 A	±(11% rdg.l+4d)	±(4% rdg.l+3d)						II 150 A				
		10.0 ... 99.9 A 100 A ... 150 A	0.1 A 1 A			±(11% rdg.l+1d)	±(4% rdg.l+1d)										
		0.0 ... 99.9 mA 100 ... 999 mA	0.1 mA 1 mA	1 V/A	5 ... 1000 mA	±(7% rdg.l+2d)	±(5% rdg.l+2d)						1 A				
		0.00 A ... 9.99 A	0.01 A			±(7% rdg.l+1d)	±(5% rdg.l+1d)										
		0.00 A ... 9.99 A 10.0 ... 99.9 A	0.01 A 0.1 A	100 mV/A	0.05 A ... 10 A	±(3.4% rdg.l+2d)	±(3% rdg.l+2d)						10 A				
		0.00 A ... 9.99 A 10.0 ... 99.9 A	0.01 A 0.1 A	10 mV/A	0.5 A ... 100 A	±(3.1% rdg.l+2d)	±(3% rdg.l+2d)							100 A			
		0.00 A ... 9.99 A 10.0 ... 99.9 A	0.01 A 0.1 A	1 mV / A	5 ... 1000 A	±(3.1% rdg.l+1d)	±(3% rdg.l+1d)						1000 A				
		10.0 ... 99.9 A 100 ... 999 A	0.1 A 1 A			±(3.1% rdg.l+2d)	±(3% rdg.l+2d)										
	0.0 ... 99.9 mA 100 ... 999 mA	0.1 mA 1 mA	1 V/A	30 ... 1000 mA	±(127% rdg.l+100d)	±(3% rdg.l+100d)						3 A					
	100 ... 999 mA	1 mA			±(27% rdg.l+11d)	±(3% rdg.l+11d)											
	0.00 ... 9.99 A	0.01 A 0.01 A	100 mV/A	0.3 ... 10 A	±(27% rdg.l+12d)	±(3% rdg.l+12d)						30 A					
	0.00 ... 9.99 A	0.01 A	10 mV/A	3 ... 100 A	±(27% rdg.l+11d)	±(3% rdg.l+11d)							300 A				
	0.00 ... 9.99 A 10.0 ... 99.9 A	0.01 A 0.1 A	10 mV/A	0.5 ... 100 A	±(27% rdg.l+100d)	±(3% rdg.l+100d)						100 A					
10.0 ... 99.9 A 10.0 ... 99.9 A	0.1 A 0.01 A	±(27% rdg.l+11d)			±(3% rdg.l+11d)												
0.00 ... 9.99 A 10.0 ... 99.9 A	0.01 A 0.1 A	1 mV / A	5 ... 1000 A	±(5% rdg.l+12d)	±(3% rdg.l+12d)						1000 A						
10.0 ... 99.9 A 10.0 ... 99.9 A	0.1 A 0.01 A			±(5% rdg.l+50d)	±(3% rdg.l+50d)												
10.0 ... 99.9 A 100 ... 999 A	0.1 A 1 A			±(5% rdg.l+7d)	±(3% rdg.l+7d)												
							±(5% rdg.l+2d)	±(3% rdg.l+2d)									

<sup>1</sup> U > 230 V with 2 or 3-pole adapter only

<sup>2</sup> 1 × I<sub>ΔN</sub> > 300 mA and 2 × I<sub>ΔN</sub> > 300 mA and 5 × I<sub>ΔN</sub> > 500 mA and I<sub>f</sub> > 300 mA only up to U<sub>N</sub> ≤ 230 V!  
5 × I<sub>ΔN</sub> > 300 mA only where U<sub>N</sub> = 230 V

<sup>3</sup> The transformation ratio selected at the clamp (1, 10, 100, 1000 mV/A) must be set in the "Type" menu with the rotary switch in the "SENSOR" position.

<sup>4</sup> Where R<sub>Eselective</sub>/R<sub>Etotal</sub> < 100

<sup>5</sup> The specified measuring and intrinsic uncertainties already include those of the respective current clamp.

<sup>6</sup> Measuring range of the signal input at the test instrument, U<sub>E</sub>: 0 ... 1.0 V<sub>RMS</sub> (0 ... 1.4 V<sub>peak</sub>) AC/DC

<sup>7</sup> Input impedance of the signal input at the test instrument: 800 kΩ

<sup>8</sup> DC bias only possible with PROFITEST MTECH+

**Key:** d = digit(s), rdg. = reading (measured value)

### 5.7 Characteristic Values for PROFITEST MXTRA and PROFITEST MPRO

Function	Measured Quantity	Display Range	Resolution	Input Impedance / Test Current	Measuring Range	Nominal Values	Measuring Uncertainty	Intrinsic Uncertainty	Connections								
									Plug Insert 1	2-Pole Adapter	3-Pole Adapter	Probe	Clamp Meters				
													WZ12C	Z3512A	MFLEX P300		
U	U <sub>L-PE</sub> U <sub>N-PE</sub>	0 ... 99.9 V 100 V ... 600 V	0.1 V 1 V	5 MΩ	DC 15.4 ... 420 Hz	U <sub>N</sub> = 120 V, 230 V, 400 V, 500 V,  f <sub>N</sub> = 16.7, 50, 60, 200, 400 Hz	±(12% rdg.+5d) ±(12% rdg.+1d)	±(11% rdg.+5d) ±(11% rdg.+1d)	•	•	•						
	f	15.0 ... 99.9 Hz 100 ... 999 Hz	0.1 Hz 1 Hz				±(10.2% rdg.+1d)	±(10.1% rdg.+1d)									
	U <sub>3 AC</sub>	0 ... 99.9 V 100 ... 600 V	0.1 V 1 V				±(13% rdg.+5d) ±(13% rdg.+1d)	±(12% rdg.+5d) ±(12% rdg.+1d)			•						
	U <sub>Probe</sub>	0 ... 99.9 V 100 ... 600 V	0.1 V 1 V				±(12% rdg.+5d) ±(12% rdg.+1d)	±(11% rdg.+5d) ±(11% rdg.+1d)				•					
	U <sub>L-N</sub>	0 ... 99.9 V 100 ... 600 V	0.1 V 1 V				±(13% rdg.+5d) ±(13% rdg.+1d)	±(12% rdg.+5d) ±(12% rdg.+1d)			•		•				
I <sub>ΔN</sub> I <sub>F</sub>	U <sub>IΔN</sub>	0 ... 70.0 V	0.1 V	0.3 × I <sub>ΔN</sub>	5 ... 70 V	U <sub>N</sub> = 120 V, 230 V, 400 V <sup>2</sup>  f <sub>N</sub> = 50, 60 Hz  U <sub>L</sub> = 25, 50 V  I <sub>ΔN</sub> = 6 mA, 10 mA, 30 mA, 100 mA, 300 mA, 500 mA <sup>2</sup>	+110% rdg.+1d	+11% rdg.-1d ... +19% rdg.+1d									
	R <sub>E</sub>	10 Ω ... 999 Ω 1.00 kΩ ... 6.51 kΩ	1 Ω 0.01 kΩ	I <sub>ΔN</sub> = 10 mA × 1.05	Calculated value from R <sub>E</sub> = U <sub>IΔN</sub> / I <sub>ΔN</sub>		U <sub>N</sub> = 120 V, 230 V, 400 V <sup>2</sup>  f <sub>N</sub> = 50, 60 Hz  U <sub>L</sub> = 25, 50 V  I <sub>ΔN</sub> = 6 mA, 10 mA, 30 mA, 100 mA, 300 mA, 500 mA <sup>2</sup>										
		3 Ω ... 999 Ω 1 kΩ ... 2.17 kΩ	1 Ω 0.01 kΩ	I <sub>ΔN</sub> = 30 mA × 1.05													
		1 Ω ... 651 Ω	1 Ω	I <sub>ΔN</sub> = 100 mA × 1.05													
		0.3 Ω ... 99.9 Ω 100 Ω ... 217 Ω	0.1 Ω 1 Ω	I <sub>ΔN</sub> = 300 mA × 1.05													
		0.2 Ω ... 9.9 Ω 10 Ω ... 130 Ω	0.1 Ω 1 Ω	I <sub>ΔN</sub> = 500 mA × 1.05													
	I <sub>F</sub> (I <sub>ΔN</sub> = 6 mA)	1.8 ... 7.8 mA	0.1 mA	1.8 ... 7.8 mA	1.8 ... 7.8 mA												
	I <sub>F</sub> (I <sub>ΔN</sub> = 10 mA)	3.0 ... 13.0 mA	0.1 mA	3.0 ... 13.0 mA	3.0 ... 13.0 mA												
	I <sub>F</sub> (I <sub>ΔN</sub> = 30 mA)	9.0 ... 39.0 mA	0.1 mA	9.0 ... 39.0 mA	9.0 ... 39.0 mA												
	I <sub>F</sub> (I <sub>ΔN</sub> = 100 mA)	30 ... 130 mA	1 mA	30 ... 130 mA	30 ... 130 mA												
	I <sub>F</sub> (I <sub>ΔN</sub> = 300 mA)	90 ... 390 mA	1 mA	90 ... 390 mA	90 ... 390 mA												
	I <sub>F</sub> (I <sub>ΔN</sub> = 500 mA)	150 ... 650 mA	1 mA	150 ... 650 mA	150 ... 650 mA												
	U <sub>IΔN</sub> / U <sub>L</sub> = 25 V	0 ... 25.0 V	0.1 V	Same as IΔ	0 ... 25.0 V												
	U <sub>IΔN</sub> / U <sub>L</sub> = 50 V	0 ... 50.0 V	0.1 V	Same as IΔ	0 ... 50.0 V												
t <sub>A</sub> (I <sub>ΔN</sub> × 1)	0 ... 1000 ms	1 ms	6 ... 500 mA	0 ... 1000 ms													
t <sub>A</sub> (I <sub>ΔN</sub> × 2)	0 ... 1000 ms	1 ms	2 × 6 mA ... 2 × 500 mA	0 ... 1000 ms													
t <sub>A</sub> (I <sub>ΔN</sub> × 5)	0 ... 40 ms	1 ms	5 × 6 mA ... 5 × 300 mA	0 ... 40 ms													
Z <sub>L-PE</sub> Z <sub>L-N</sub>	Z <sub>L-PE</sub> (AC) Z <sub>L-N</sub>	0 mΩ ... 999 mΩ 1.00 Ω ... 9.99 Ω	1 mΩ 0.01 Ω	3.7 A AC ... 4.7 A AC	0.10 Ω ... 0.49 Ω 0.50 Ω ... 0.99 Ω 1.00 Ω ... 9.99 Ω	U <sub>N</sub> = 120, 230, 400, 500 V <sup>1</sup> f <sub>N</sub> = 16.7 Hz, 50 Hz, 60 Hz	±(10% rdg.+20d) ±(10% rdg.+10d) ±(5% rdg.+3d)	±(15% rdg.+20d) ±(14% rdg.+20d) ±(3% rdg.+3d)									
	Z <sub>L-PE</sub> + DC <sup>8</sup>	0 mΩ ... 999 mΩ 1.00 Ω ... 9.99 Ω 10.0 Ω ... 29.9 Ω	0.1 Ω	3.7 ... 4.7 A AC 0.5, 1.25 A DC <sup>8</sup>	0.25 Ω ... 0.99 Ω 1.00 Ω ... 9.99 Ω	U <sub>N</sub> = 120, 230 V f <sub>N</sub> = 50, 60 Hz	±(18% rdg.+30d) ±(10% rdg.+3d)	±(16% rdg.+50d) ±(4% rdg.+3d)									
	I <sub>SC</sub> (Z <sub>L-PE</sub> ) Z <sub>L-PE</sub> + DC <sup>8</sup>	0 to 9.9 A 10 ... 999 A 1.00 ... 9.99 kA 10.0 ... 50.0 kA	0.1 A 1 A 10 A 100 A		120 (108 ... 132) V 230 (196 ... 253) V 400 (340 ... 440) V 500 (450 ... 550) V			Value calculated from Z <sub>L-PE</sub>									
	Z <sub>L-PE</sub> (15 mA)	0.6 Ω ... 99.9 Ω 100 Ω ... 999 Ω	0.1 Ω 1 Ω		10.0 Ω ... 99.9 Ω 100 Ω ... 999 Ω	U <sub>N</sub> = 120, 230 V f <sub>N</sub> = 16.7, 50, 60 Hz	±(10% rdg.+10d) ±(8% rdg.+2d)	±(2% rdg.+2d) ±(1% rdg.+1d)									
	I <sub>SC</sub> (15 mA)	0.10 ... 9.99 A 10.0 ... 99.9 A 100 ... 999 A <sup>11</sup>	0.01 A 0.1 A 1 A	15 mA AC	100 ... 12 A (U <sub>N</sub> = 120 V) 200 mA ... 25 A (U <sub>N</sub> = 230 V)			Value calculated from I <sub>SC</sub> = U <sub>N</sub> / Z <sub>L-PE</sub> (15 mA)									
R <sub>E</sub>	R <sub>E,sl</sub> (without probe) R <sub>E</sub> (with probe)	0 mΩ ... 999 mΩ 1.00 Ω ... 9.99 Ω 10.0 Ω ... 99.9 Ω 100 Ω ... 999 Ω 1 kΩ ... 9.99 kΩ	1 mΩ 0.01 Ω 0.1 Ω 1 Ω 0.01 kΩ	3.7 ... 4.7 A AC 3.7 ... 4.7 A AC 400 mA AC 40 mA AC 4 mA AC	0.10 Ω ... 0.49 Ω 0.50 Ω ... 0.99 Ω 1.0 Ω ... 9.99 Ω 10 Ω ... 99.9 Ω 100 Ω ... 999 Ω 1 kΩ ... 9.99 kΩ	U <sub>N</sub> same as function U <sup>1</sup> f <sub>N</sub> = 50, 60 Hz	±(10% rdg.+20d) ±(10% rdg.+10d) ±(5% rdg.+3d) ±(10% rdg.+3d) ±(10% rdg.+3d) ±(10% rdg.+3d)	±(15% rdg.+20d) ±(14% rdg.+20d) ±(3% rdg.+3d) ±(3% rdg.+3d) ±(3% rdg.+3d) ±(3% rdg.+3d)									
	R <sub>E</sub> (15 mA) (without/with probe)	0.5 Ω ... 99.9 Ω 100 Ω ... 999 Ω	0.1 Ω 1 Ω	15 mA AC	10 Ω ... 99.9 Ω 100 Ω ... 999 Ω	U <sub>N</sub> = 120, 230 V f <sub>N</sub> = 50, 60 Hz	±(10% rdg.+10d) ±(8% rdg.+2d)	±(2% rdg.+2d) ±(1% rdg.+1d)									
	R <sub>E,sl</sub> (without probe) R <sub>E,sl</sub> (with probe)	0 mΩ ... 999 mΩ 1.00 Ω ... 9.99 Ω 10.0 Ω ... 29.9 Ω	1 mΩ 0.01 Ω 0.1 Ω	3.7 ... 4.7 A AC 0.5, 1.25 A DC <sup>8</sup>	0.25 Ω ... 0.99 Ω 1.00 Ω ... 9.99 Ω	U <sub>N</sub> = 120, 230 V f <sub>N</sub> = 50, 60 Hz	±(18% rdg.+30d) ±(10% rdg.+3d)	±(16% rdg.+50d) ±(4% rdg.+3d)									
	U <sub>E</sub>	0 ... 253 V	1 V	3.7 ... 4.7 A AC	RE = 0.10 ... 9.99 W	U <sub>N</sub> = 120, 230 V f <sub>N</sub> = 50, 60 Hz		Calculated U <sub>E</sub> = U <sub>N</sub> × R <sub>E</sub> / R <sub>E,sl</sub>									
	R <sub>E,sel</sub> (only with probe)	0 mΩ ... 999 mΩ 1.00 Ω ... 9.99 Ω 10.0 Ω ... 99.9 Ω 100 Ω ... 999 Ω	1 mΩ 0.01 Ω 0.1 Ω 1 Ω	2.1 A AC 2.1 A AC 400 mA AC 40 mA AC	0.25 Ω ... 300 Ω <sup>4</sup>	U <sub>N</sub> = 120, 230 V f <sub>N</sub> = 50, 60 Hz	±(20% rdg.+20d)	±(15% rdg.+20d)									
R <sub>E,sel</sub> + DC <sup>8</sup> (only with probe)	0 mΩ ... 999 mΩ 1.00 Ω ... 9.99 Ω 10.0 Ω ... 99.9 Ω 100 Ω ... 999 Ω	1 mΩ 0.01 Ω 0.1 Ω 1 Ω	3.7 ... 4.7 A AC 0.5, 1.25 A DC <sup>8</sup>	0.25 Ω ... 300 Ω R <sub>E,tot</sub> < 10 Ω <sup>4</sup>	U <sub>N</sub> = 120, 230 V f <sub>N</sub> = 50, 60 Hz	±(22% rdg.+20d)	±(15% rdg.+20d)										
EXTRA	Z <sub>ST</sub>	10 kΩ ... 199 kΩ 200 kΩ ... 999 kΩ 1.00 MΩ ... 9.99 MΩ 10.0 MΩ ... 30.0 MΩ	1 kΩ 1 kΩ 0.01 MΩ 0.1 MΩ	2.3 mA at 230 V	10 kΩ ... 199 kΩ 200 kΩ ... 999 kΩ 1.00 MΩ ... 9.99 MΩ 10.0 MΩ ... 30.0 MΩ	U <sub>0</sub> = U <sub>L-N</sub>	±(20% rdg.+2d) ±(10% rdg.+3d)	±(10% rdg.+3d) ±(5% rdg.+3d)									

# Characteristic Values for PROFITEST MXTRA and PROFITEST MPRO

Function	Measured Quantity	Display Range	Resolution	Test Current	Measuring Range	Nominal Values	Measuring Uncertainty	Intrinsic Uncertainty	Connections								
									Plug Insert <sup>1</sup>	2-Pole Adapter	3-Pole Adapter	Clamps / Meas. Ranges					
									WZ12C	Z3512A	MFLEX P300	CP1100					
EXTRA	IMD test	20 kΩ ... 648 kΩ 2.51 MΩ	1 kΩ 0.01 MΩ	IT line voltage $U_N = 90 \dots 550 \text{ V}$	20 kΩ ... 199 kΩ 200 kΩ ... 648 kΩ 2.51 MΩ	IT system nominal voltages $U_N = 120 \text{ V}, 230 \text{ V}, 400 \text{ V}, 500 \text{ V}$ $f_N = 50, 60 \text{ Hz}$	±7% ±12% ±3%	±5% ±10% ±2%	•		•						
R <sub>ISO</sub>	R <sub>INS</sub> , R <sub>EINS</sub>	1 kΩ ... 999 kΩ 1.00 MΩ ... 9.99 MΩ 10.0 MΩ ... 49.9 MΩ	1 kΩ 10 kΩ 100 kΩ	I <sub>SC</sub> = 1.5 mA	50 kΩ ... 999 kΩ 1.00 MΩ ... 49.9 MΩ	$U_N = 50 \text{ V}$ $I_N = 1 \text{ mA}$	KΩ range ±(15% rdg.l+10d) MΩ range ±(15% rdg.l+1d)	kΩ range ±(13% rdg.l+10d) MΩ range ±(13% rdg.l+1d)	•	•							
		1 kΩ ... 999 kΩ 1.00 MΩ ... 9.99 MΩ 10.0 MΩ ... 99.9 MΩ 100 MΩ ... 200 MΩ	1 kΩ 10 kΩ 100 kΩ 1 MΩ		50 kΩ ... 999 kΩ 1.00 MΩ ... 200 MΩ	$U_N = 100 \text{ V}$ $I_N = 1 \text{ mA}$											
		1 ... 999 kΩ 1.00 ... 9.99 MΩ 10.0 ... 99.9 MΩ 100 ... 500 MΩ	1 kΩ 10 kΩ 100 kΩ 1 MΩ		50 kΩ ... 999 kΩ 1.00 MΩ ... 499 MΩ	$U_N = 250 \text{ V}$ $I_N = 1 \text{ mA}$											
		1 ... 999 kΩ 1.00 ... 9.99 MΩ 10.0 ... 99.9 MΩ 100 ... 500 MΩ	1 kΩ 10 kΩ 100 kΩ 1 MΩ		50 kΩ ... 999 kΩ 1.00 MΩ ... 499 MΩ	$U_N = 325 \text{ V}$ $U_N = 500 \text{ V}$ $U_N = 1000 \text{ V}$ $I_N = 1 \text{ mA}$											
	U	10 ... 999 V DC 1.00 ... 1.19 kV	1 V 10 V	10 ... 1.19 kV		±(3% rdg.l+1d)	±(1.5% rdg.l+1d)										
R <sub>LO</sub>	R <sub>LO</sub>	0.00 Ω ... 9.99 Ω 10.0 Ω ... 99.9 Ω 100 Ω ... 199 Ω	0.01 Ω 0.1 Ω 1 Ω	I ≥ 200 mA DC I < 260 mA DC	0.10 Ω ... 5.99 Ω 6.00 Ω ... 99.9 Ω	$U_0 = 4.5 \text{ V}$	±(4% rdg.l+2d)	±(2% rdg.l+2d)		•							
	R <sub>OFFSET</sub>	0.00 Ω ... 9.99 Ω	0.01 Ω	I ≥ 200 mA DC I < 260 mA DC	0.10 Ω ... 5.99 Ω 6.00 Ω ... 99.9 Ω												
				Transformation ratio 3			5	5									
SENSOR 6, 7	I <sub>L/Amp</sub>	0.0 ... 99.9 mA	0.1 mA	1 V/A	5 ... 15 A	$f_N = 50, 60 \text{ Hz}$	±(13% rdg.l+5d)	±(5% rdg.l+4d)									
		100 ... 999 mA	1 mA				±(13% rdg.l+1d)	±(5% rdg.l+1d)								I 15A	
		1.00 ... 9.99 A	0.01 A				±(11% rdg.l+4d)	±(4% rdg.l+3d)									
		10.0 ... 15.0 A	0.1 A	1 mV / A	5 ... 150 A	±(11% rdg.l+1d)	±(4% rdg.l+1d)	II 150 A									
		1.00 ... 9.99 A	0.01 A			±(7% rdg.l+2d)	±(5% rdg.l+2d)										
		10.0 ... 99.9 A	0.1 A			±(7% rdg.l+1d)	±(5% rdg.l+1d)										
		100 ... 999 mA	1 mA	100 mV/A	0.05 ... 10 A	$f_N = 16.7, 50, 60, 200, 400 \text{ Hz}$	±(3.4% rdg.l+2d)	±(3% rdg.l+2d)									
		0.00 ... 9.99 A	0.01 A				±(3.1% rdg.l+2d)	±(3% rdg.l+2d)									1 A
		10.0 ... 99.9 A	0.1 A				±(3.1% rdg.l+1d)	±(3% rdg.l+1d)									
		100 ... 999 A	1 A	10 mV/A	0.5 ... 100 A	±(3.1% rdg.l+1d)	±(3% rdg.l+1d)	100 A									
		0.00 ... 9.99 A	0.01 A			±(3.1% rdg.l+2d)	±(3% rdg.l+2d)										
		10.0 ... 99.9 A	0.1 A			±(3.1% rdg.l+2d)	±(3% rdg.l+2d)										
		100 ... 999 A	1 A	1 mV / A	5 ... 1000 A	±(3.1% rdg.l+1d)	±(3% rdg.l+1d)	1000 A									
		0.0 ... 99.9 mA	0.1 mA			±(27% rdg.l+100d)	±(3% rdg.l+100d)		3 A								
		100 ... 999 mA	1 mA			±(27% rdg.l+11d)	±(3% rdg.l+11d)										
		0.00 ... 9.99 A	0.01 A	100 mV/A	0.3 ... 10 A	$f_N = 50, 60 \text{ Hz}$	±(27% rdg.l+12d)	±(3% rdg.l+12d)									
10.0 ... 99.9 A	0.1 A	±(27% rdg.l+11d)	±(3% rdg.l+11d)				30 A										
0.00 ... 9.99 A	0.01 A	±(27% rdg.l+100d)	±(3% rdg.l+100d)														
10.0 ... 99.9 A	0.1 A	10 mV/A	3 ... 100 A	±(27% rdg.l+11d)	±(3% rdg.l+11d)	300 A											
0.00 ... 9.99 A	0.01 A			±(15% rdg.l+12d)	±(3% rdg.l+12d)		100 A										
10.0 ... 99.9 A	0.1 A			±(15% rdg.l+2d)	±(3% rdg.l+2d)												
0.00 ... 9.99 A	0.01 A	1 mV / A	5 ... 1000 A	$f_N = \text{DC}, 16.7 \text{ Hz}, 50 \text{ Hz}, 60 \text{ Hz}, 200 \text{ Hz}$	±(15% rdg.l+50d)	±(3% rdg.l+50d)											
10.0 ... 99.9 A	0.1 A				±(15% rdg.l+7d)	±(3% rdg.l+7d)									1000 A		
100 ... 999 A	1 A				±(15% rdg.l+2d)	±(3% rdg.l+2d)											

<sup>1</sup> U > 230 V, with 2 or 3-pole adapter only

<sup>2</sup>  $1 \times I_{\Delta N} > 300 \text{ mA}$  and  $2 \times I_{\Delta N} > 300 \text{ mA}$  and  $5 \times I_{\Delta N} > 500 \text{ mA}$  and  $I_f > 300 \text{ mA}$  only up to  $U_N \leq 230 \text{ V}$ !

<sup>3</sup> The transformation ratio selected at the clamp (1/10/100/1000 mV/A) must be set in the "Type" menu with the rotary switch in the "SENSOR" position.

<sup>4</sup> Where  $R_{\text{Eselective}}/R_{\text{Etotal}} < 100$

<sup>5</sup> The specified measuring and intrinsic uncertainties already include those of the respective current clamp.

<sup>6</sup> Measuring range of the signal input at the test instrument,  $U_E: 0 \dots 1.0 V_{\text{TRMS}} (0 \dots 1.4 V_{\text{peak}}) \text{ AC/DC}$

<sup>7</sup> Input impedance of the signal input at the test instrument: 800 kΩ

<sup>8</sup> DC bias only possible with PROFITEST MXTRA

<sup>11</sup> Where  $Z_{L-PE} < 0.6 \Omega$ ,  $I_{SC} > U_N/0.5 \Omega$  is displayed

**Key:** d = digit(s), rdg. = reading (measured value)

## Characteristic Values, Special Measurements with PROFITEST MPRO and PROFITEST MXTRA

Function	Measured Quantity	Display Range	Resolution	Test Current / Signal Freq. 1	Measuring Range	Measuring Uncertainty	Intrinsic Uncertainty	Connections			
								Adapter for Test Plug		Current Clamps	
								PRO-RE	PRO-RE/2	Z3512A	Z591B
RE BAT	RE, 3-pole	0.00 Ω ... 9.99 Ω 10.0 Ω ... 99.9 Ω 100 Ω ... 999 Ω	0.01 Ω 0.1 Ω 1 Ω	16 mA/128 Hz 1.6 mA/128 Hz 0.16 mA/128 Hz	1.00 Ω ... 19.9 Ω 5.0 Ω ... 199 Ω 50 Ω ... 1.99 kΩ	±((10% rdg.l+10d + 1 Ω))	±((3% rdg.l+5d + 0.5 Ω))	2			
	RE, 4-pole	1.00 kΩ ... 9.99 kΩ 10.0 kΩ ... 50.0 kΩ	0.01 kΩ 0.1 kΩ	0.16 mA/128 Hz 0.16 mA/128 Hz	0.50 kΩ ... 19.9 kΩ 0.50 kΩ ... 49.9 kΩ	±((10% rdg.l+10d))	±((3% rdg.l+5d))				
	RE, 4-pole selective with clamp meter	0.00 Ω ... 9.99 Ω 10.0 Ω ... 99.9 Ω 100 Ω ... 999 Ω 1.00 kΩ ... 9.99 kΩ <sup>10</sup> 10.0 kΩ ... 19.9 kΩ <sup>10</sup> 10.0 kΩ ... 49.9 kΩ <sup>11</sup>	0.01 Ω 0.1 Ω 1 Ω 0.01 kΩ 0.1 kΩ 0.1 kΩ	16 mA/128 Hz 1.6 mA/128 Hz 1.6 mA/128 Hz 0.16 mA/128 Hz 0.16 mA/128 Hz 0.16 mA/128 Hz	1.00 Ω ... 9.99 Ω 10.0 Ω ... 200 Ω	±((15% rdg.l+10d)) ±((20% rdg.l+10d) <sub>6</sub> )	±((10% rdg.l+10d)) ±((15% rdg.l+10d))	2		5	
	Soil resistivity (ρ)	0.0 Ωm ... 9.9 Ωm 100 Ωm ... 999 Ωm 1.00 Ωm ... 9.99 kΩm	0.1 Ωm 1 Ωm 0.01 kΩm	16 mA/128 Hz 1.6 mA/128 Hz 0.16 mA/128 Hz 0.16 mA/128 Hz	100 Ωm ... 9.99 kΩm <sup>8</sup> 500 Ωm ... 9.99 kΩm <sup>8</sup> 5.00 kΩm ... 9.99 kΩm <sup>9</sup> 5.00 kΩm ... 9.99 kΩm <sup>9</sup> 5.00 kΩm ... 9.99 kΩm <sup>9</sup>	±((20% rdg.l+10d) <sub>7</sub> )	±((12% rdg.l+10d) <sub>7</sub> )	2			
	Probe clearance d (p)	0.1 ... 999 m									
	RE, 2 clamps	0.00 Ω ... 9.99 Ω 10.0 Ω ... 99.9 Ω 100 Ω ... 999 Ω 1.00 Ω ... 1.99 kΩ	0.01 Ω 0.1 Ω 1 Ω 0.01 kΩ	30 V / 128 Hz	0.10 Ω ... 9.99 Ω 10.0 Ω ... 99.9 Ω	±((10% rdg.l+5d)) ±((20% rdg.l+5d))	±((5% rdg.l+5d)) ±((12% rdg.l+5d))		3	5	4

<sup>1</sup> Signal frequency without interference signal

**Key:** d = digit(s), rdg. = reading (measured value)

<sup>2</sup> PRO-RE (Z501S) adapter cable for test plug, for connecting earth probes (E-Set 3/4)

<sup>3</sup> PRO-RE/2 adapter cable for test plug, for connecting the E-CLIP2 generator clamp

<sup>4</sup> Generator clamp: E-CLIP2 (Z591B)

<sup>5</sup> Clamp meter: Z3512A (Z225A)

<sup>6</sup> Where  $R_{E,sel}/R_E < 10$  or clamp meter current  $> 500 \mu A$

<sup>7</sup> Where  $R_{E,H}/R_E \leq 100$  and  $R_{E,E}/R_E \leq 100$

<sup>8</sup> Where d = 20 m

<sup>9</sup> Where d = 2 m

<sup>10</sup> Only where RANGE = 20 kΩ

<sup>11</sup> Only where RANGE = 50 kΩ or AUTO

## 6 Operating and Display Elements

### 6.1 Control Panel

The display and control panel can be swiveled forward or backward with the detented swivel hinge. The instrument can thus be set to the optimum reading angle.

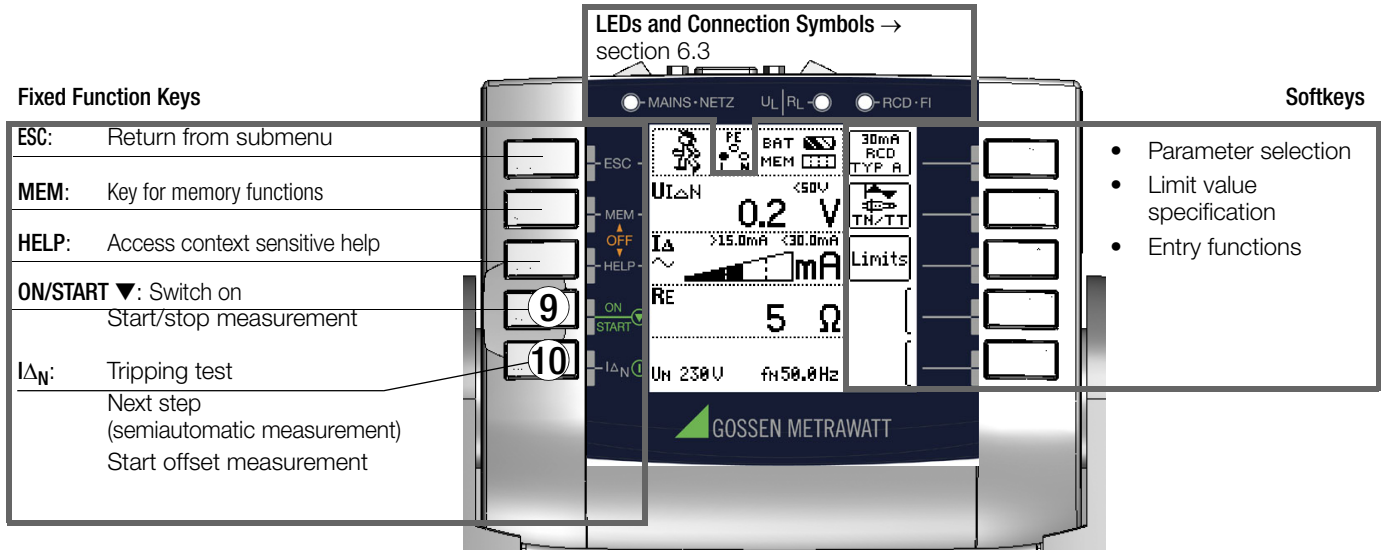

### 6.2 Display

The following appear at the display:

- One or two measurement values as three place numeric display with unit of measure and abbreviated measured quantity
- Nominal values for voltage and frequency
- Circuit diagrams
- On-line help
- Messages and instructions

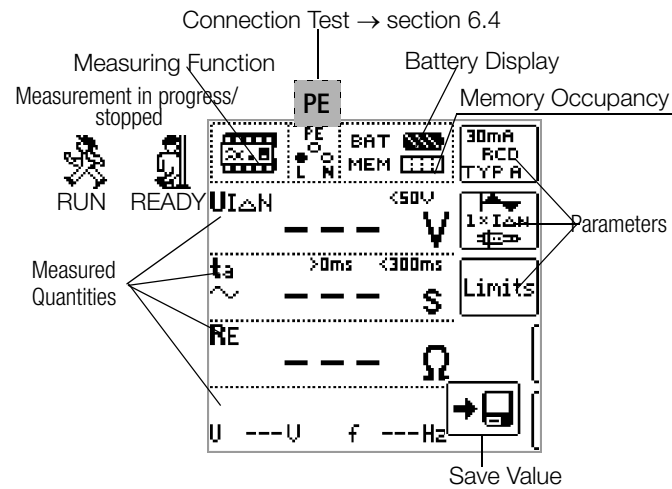

### 6.3 LEDs

#### MAINS/NETZ LED

This LED is only functional when the instrument is switched on. It has no function in the voltage ranges  $U_{L-N}$  and  $U_{L-PE}$ . It lights up green, red or orange, or blinks green or red depending upon how the instrument has been connected and the selected function (see also section 6.4, "LED Indications, Mains Connections and Potential Differences", beginning on page 17). This LED also lights up if line voltage is present when measuring  $R_{ISO}$  and  $R_{LO}$ .

#### $U_L/R_L$ LED

This LED lights up red if touch voltage is greater than 25 V or 50 V during RCD testing, as well as after safety shutdown occurs. It also lights up if  $R_{ISO}$  or  $R_{LO}$  limit values have been exceeded or fallen short of.

#### RCD • FI LED

This LED lights up red if the RCCB is not tripped within 400 ms (1000 ms for selective RCCBs – type RCD S) during the tripping test with nominal residual current. It also lights up if the RCCB is not tripped before nominal residual current has been reached during measurement with rising residual current.

#### Battery Display (→ section 7.1)

- BAT** [Full bar] Battery full
- BAT** [Weak bar] Battery weak
- BAT** [OK bar] Battery OK
- BAT** [Dead bar] Battery (almost) dead  $U < 8 V$

#### Memory Occupancy Display

- MEM** [Full bar] Memory full > transfer data to PC
- MEM** [Half bar] Memory half full

#### Connection Test – Mains Connection Test (→ section 6.4)

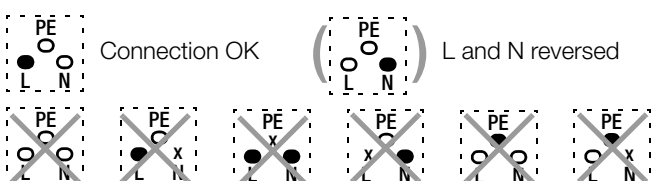

#### Attention!

The mains connection test may not be used to test systems or system components for the absence of voltage!



## 6.4 LED Indications, Mains Connections and Potential Differences

### LED Signals











	Status	Test Plug	Measuring Adapter	Function Switch Position	Function/Meaning
<b>NETZ/MAINS</b>	Lights up green	X		$I_{\Delta N} / I_{F\Delta}$ , $Z_{L-N} / Z_{L-PE} / R_E$ , $\Delta U$ , $Z_{ST}$ , kWh, IMD, int. ramp, RCM	Correct connection, measurement enabled
<b>NETZ/MAINS</b>	Blinks green		X	$I_{\Delta N} / I_{F\Delta}$ , $Z_{L-N} / Z_{L-PE} / R_E$ , $\Delta U$ , $Z_{ST}$ , kWh, IMD, int. ramp, RCM	N conductor not connected, measurement enabled
<b>NETZ/MAINS</b>	Blinks red	X	X	$I_{\Delta N} / I_{F\Delta}$ , $Z_{L-N} / Z_{L-PE} / R_E$ , $\Delta U$ , $Z_{ST}$ , kWh, IMD, int. ramp, RCM	1) No line voltage or 2) PE interrupted
<b>NETZ/MAINS</b>	Lights up red		X	$R_{LO}$ , $R_{ISO}$ , $R_E$ , $I_L$ , sensor	Interference voltage is present at the test probes. Measurement is disabled.
<b>NETZ/MAINS</b>	Blinks yellow		X	$I_{\Delta N} / I_{F\Delta}$ , $Z_{L-N} / Z_{L-PE} / R_E$	L and N are connected to the phase conductors.
<b><math>U_L/R_L</math></b>	Lights up red	X	X	$R_{INS}$ , $R_{LO}$ , $R_E$ , $Z_{L-N}$ , $Z_{L-PE}$ , $\Delta U$ , $I_L$ , $U_{res}$ , sensor	The selected limit value has been violated.
				$R_E$ , $Z_{L-PE}$ , $I_{F\Delta}$ , $I_{\Delta N}$ , $t_a + \Delta I$ , RCM	Interference voltage limit value $U_L$ has been exceeded. → Safety shutdown has occurred.
				$Z_{L-N}$ , $Z_{L-PE}$ , $Z_{ST}$ , IMD, kWh, RCM, PRCD, e-mobility	The test has been manually assessed as "NOT OK".
<b>FI/RCD</b>	Lights up red	X	X	$I_{\Delta N} / I_{F\Delta}$ , int. ramp	The RCCB was not tripped, or was tripped too late during the tripping test.

### Mains Connection Test — Single-Phase System — LCD Connection Pictographs











#### Attention!







The mains connection test may not be used to test systems or system components for the absence of voltage!

	Status	Test Plug	Measuring Adapter	Function Switch Position	Function/Meaning
	Is displayed			All except for U	No connection detected
	Is displayed			All except for U	Connection OK
	Is displayed			All except for U	L and N reversed, neutral conductor charged with phase voltage
	Is displayed			All except U and RE	No mains connection
				RE	Standard display without connection messages
	Is displayed			All except for U	Neutral conductor interrupted
	Is displayed			All except for U	Protective conductor PE interrupted, neutral conductor N and/or phase conductor L charged with phase voltage
	Is displayed			All except for U	Phase conductor L interrupted, neutral conductor N charged with phase voltage
	Is displayed			All except for U	Phase conductor L and protective conductor PE reversed
	Is displayed			All except for U	Phase conductor L and protective conductor PE reversed Neutral conductor interrupted (with probe only)
	Is displayed			All except for U	L and N are connected to the phase conductors.



**!** **Attention!**  
 The mains connection test may not be used to test systems or system components for the absence of voltage!

	Status	Test Plug	Measuring Adapter	Function Switch Position	Function/Meaning
	Is displayed			U (3-phase measurement)	Clockwise rotation
	Is displayed			U (3-phase measurement)	Counter-clockwise rotation
	Is displayed			U (3-phase measurement)	Short between L1 and L2
	Is displayed			U (3-phase measurement)	Short between L1 and L3
	Is displayed			U (3-phase measurement)	Short between L2 and L3
	Is displayed			U (3-phase measurement)	Conductor L1 missing
	Is displayed			U (3-phase measurement)	Conductor L2 missing
	Is displayed			U (3-phase measurement)	Conductor L3 missing
	Is displayed			U (3-phase measurement)	Conductor L1 to N
	Is displayed			U (3-phase measurement)	Conductor L2 to N
	Is displayed			U (3-phase measurement)	Conductor L3 to N





## Connection Test — Battery Powered Earthing Resistance Measurements, “Battery Mode”











	Status	Test Plug	Measuring Adapter	Function Switch Position	Function/Meaning
	Is displayed			$R_E$	Standard display without connection messages
	Is displayed		PRO-RE	$R_E$	Interference voltage at probe S > 3 V Restricted measuring accuracy
	Is displayed		Clamp meter	$R_E$	Interference/measuring current ratio > 50 at $R_{E(sel)}$ , 1000 at $R_{E(2Z)}$ Restricted measuring accuracy at $R_{E(sel)}$ : Interference current > 0.85 A or interference/measuring current ratio > 100 ↻ No measured value, display: RE.Z ---
	Is displayed		PRO-RE	$R_E$	Probe H not connected or $R_{E,H} > 150 \text{ k}\Omega$ ↻ No measurement, display: RE --- $R_{E,H} > 50 \text{ k}\Omega$ or $R_{E,H}/R_E > 10000$ ↻ Measured value is displayed, restricted measuring accuracy
	Is displayed		PRO-RE	$R_E$	Probe S not connected or $R_{E,S} > 150 \text{ k}\Omega$ or $R_{E,S} \times R_{E,H} > 25 \text{ M}\Omega^2$ ↻ No measurement, display: RE --- $R_{E,S} > 50 \text{ k}\Omega$ or $R_{E,S}/R_E > 300$ ↻ Measured value is displayed, restricted measuring accuracy
	Is displayed		PRO-RE	$R_E$	Probe E not connected or $R_{E,E} > 150 \text{ k}\Omega$ , $R_{E,E}/R_E > 2000$ ↻ No measurement, display: RE --- $R_{E,E}/R_E > 300$ ↻ Measured value is displayed, restricted measuring accuracy

### PE Test via Finger Contact at the Contact Surfaces on the Test Plug





	Status	Test Plug	Measuring Adapter	Function Switch Position	Function/Meaning
<b>LCD</b>	<b>LEDs</b>				
	UL/RL FI/RCD light up red	X	X	U (single-phase measurement)	Potential difference $\geq 50 \text{ V}$ between finger contact and PE (earth contact) Frequency $f \geq 50 \text{ Hz}$
	$U_L/R_L$ FI/RCD light up red	X	X	U (single-phase measurement)	If L is correctly contacted and PE is interrupted (frequency $f \geq 50 \text{ Hz}$ )





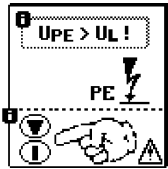

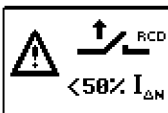

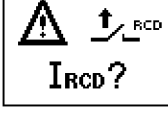
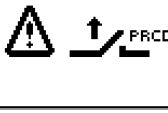
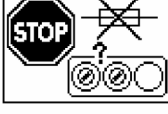
### Status bar: Display of Charge Level, Memory Occupancy

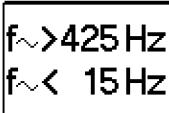
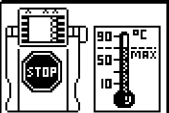

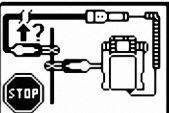

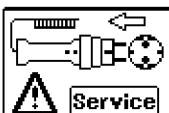

	Status	Test Plug	Measuring Adapter	Function Switch Position	Function/Meaning
<b>Battery status</b>					
	Is displayed			U, $R_{INS}$ , $R_{LO}$ , $R_E$ , $Z_{L-N}$ , $Z_{L-PE}$ , $I_F$ , $I_{\Delta N}$ , Setup, EXTRA, SENSOR	Battery charge level $\geq 80\%$
	Is displayed				Battery charge level $\geq 50\%$
	Is displayed				Battery charge level $\geq 30\%$
	Is displayed				Battery charge level $\geq 15\%$
	Is displayed				Battery charge level $\geq 0\%$

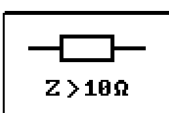
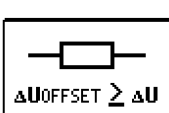
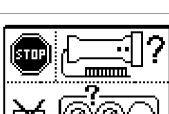
Battery test					
	Is displayed			All	Rechargeable batteries must be recharged or replaced towards the end of their service life ( $U < 8 \text{ V}$ ).
<b>Memory Status</b>					
	Is displayed			$U,$ $R_{INS},$ $R_{LO}, R_E,$ $Z_{L-N}, Z_{L-PE},$ $I_{F\Delta}, I_{\Delta N},$ Setup, EXTRA, SENSOR	Memory occupancy $\geq 100\%$
	Is displayed				Memory occupancy $\geq 87.5\%$
	Is displayed				Memory occupancy $\geq 75\%$
	Is displayed				Memory occupancy $\geq 62.5\%$
	Is displayed				Memory occupancy $\geq 50\%$
	Is displayed				Memory occupancy $\geq 37.5\%$
	Is displayed				Memory occupancy $\geq 25\%$
	Is displayed				Memory occupancy $\geq 12.5\%$
	Is displayed				Memory occupancy $\geq 0\%$

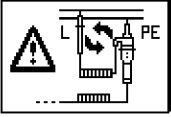
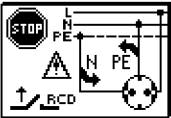
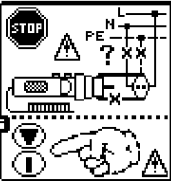
### Error Messages — LCD Connection Pictographs

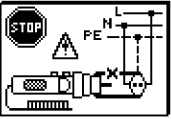
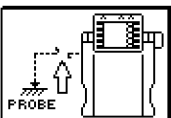
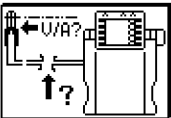
Status	Test Plug	Measuring Adapter	Function Switch Position	Function/Meaning
	X	X	All measurements with protective conductor	Potential difference $\geq U_L$ between finger contact and PE (earth contact) (frequency $f \geq 50 \text{ Hz}$ ) Remedy: Check PE connection Note: Only if  is displayed: Measurement can nevertheless be started by pressing the start key again.
	X	X	$I_{\Delta N} / I_{F\Delta}$ $Z_{L-N} / Z_{L-PE} / R_E$	1) Voltage too high ( $U > 253 \text{ V}$ ) for RCD test with direct current 2) $U$ always $U > 550 \text{ V}$ with 500 mA 3) $U > 440 \text{ V}$ for $I_{\Delta N} / I_{F\Delta}$ 4) $U > 253 \text{ V}$ for $I_{\Delta N} / I_{F\Delta}$ with 500 mA 5) $U > 253 \text{ V}$ for measurement with probe
	X	X	$I_{\Delta N}$	RCD is tripped too early or is defective. Remedy: Test circuit for bias current
	X	X	$Z_{L-PE}$	RCD is tripped too early or is defective. Remedy: Test with "DC + positive half-wave".
	X	X	$I_{\Delta N} / I_{F\Delta}$	RCD tripped during touch voltage measurement. Remedy: Check selected nominal test current.
			$R_{LO}, I_{F\Delta}, I_{\Delta N},$ EXTRA $\rightarrow ta+I\Delta$	The PRCD has been tripped. Reason: Poor contact or defective PRCD
	X	X	All except for $U$	Externally accessible fuse is blown. The voltage ranges remain functional even if fuses have blown. <b>Special case, <math>R_{LO}</math>:</b> Interference voltage during measurement may result in a blown fuse. Remedy: Replace fuse as described in section 21.2.

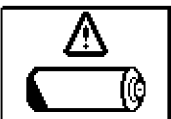
	X	X	$I_{\Delta N} / I_F \triangle$ $Z_{L-N} / Z_{L-PE} / R_E$	Frequency out of permissible range Remedy: Check the mains connection.
			All	Excessive temperature inside the test instrument Remedy: Wait for test instrument to cool down
	X	X	$R_{INS} / R_{LO}$	Interference voltage Remedy: Device under test must be disconnected from all sources of voltage
		PRO-RE	RE (bat)	Interference voltage > 20 V at the probes: H to E or S to E No measurement possible
	X	PRO-RE	RE (bat)	Probe ES not connected or connected incorrectly
		PRO-RE/ 2	RE (bat)	Generator current clamp (E-Clip-2) not connected
	X	X	All measurements with probe	Interference voltage at the probe
	X	X	$R_{ISO}$	Overvoltage or overloading of the measuring voltage generator during measurement of $R_{INS}$ Remedy: Ensure absence of voltage at the device under test.
	X	X	$I_{\Delta N} / I_F \triangle$ $Z_{L-N} / Z_{L-PE}$ $Z_{ST}, R_{ST}, R_E$ Meter startup	No mains connection Remedy: Check the mains connection.
	X	X	All	Defective hardware Remedy: 1) Switch on/off or 2) Briefly remove the batteries. If error message persists, send instrument to GMC-I Service GmbH.
	X	X	$R_{LO}$	OFFSET measurement is not sensible. Remedy: Check system. OFFSET measurement of $R_{LO+}$ and $R_{LO-}$ is still possible.
		X	$R_{LO}$	$R_{OFFSET} > 9.99 \Omega$ : OFFSET measurement is not sensible. Remedy: Check system.
		X	EXTRA → $\Delta U$	$Z > 9.99 \Omega$ : OFFSET measurement is not sensible. Remedy: Check system.
		X	EXTRA → $\Delta U$	$\Delta U_{OFFSET} > \Delta U$ : OFFSET value is greater than the measured value at the consuming system. OFFSET measurement is not sensible. Remedy: Check system.
	X	X	$R_{ISO} / R_{LO} / R_{E(bat)}$	Contact problem or blown fuse Remedy: Check test plug or measuring adapter for correct seating in the test plug, or replace the fuse.

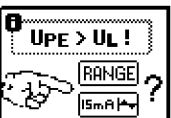

	X		$R_E$	The polarity of the 2-pole adapter must be reversed.																								
	X		$I_{\Delta N} / I_F$	N and PE are reversed.																								
	X	X	$I_{\Delta N} / I_F$ $Z_{L-N} / Z_{L-PE} / R_E$	<p>1) Mains connection error Remedy: Check the mains connection. or</p> <p>2) Display at the connection pictograph: PE interrupted (x) or bottom protective conductor bar interrupted with reference to the keys at the test plug Cause: Voltage measuring path interrupted Result: Measurement is disabled</p> <p>Note: Only if  is displayed: Measurement can nevertheless be started by pressing the start key again.</p>																								
	X		$I_{\Delta N} / I_F$	<p>Display at the connection pictograph: Top protective conductor bar interrupted with reference to the keys at the test plug Cause: <b>Current measuring path</b> interrupted Result: No measured value display</p>																								
			$R_E$ $I_{\Delta N} / I_F$	<p>Probe is not detected, probe not connected Remedy: Check probe connection.</p>																								
			$R_E$	<p>Clamp is not detected:</p> <ul style="list-style-type: none"> <li>– Clamp is not connected or</li> <li>– Current through clamp is too small (partial earthing resistance too high) or</li> <li>– Transformation ratio set incorrectly</li> </ul> <p>Remedy: Check clamp connection and transformation ratio. Check the batteries in the METRAFLEX P300 and replace if necessary.</p>																								
			$R_E$	If you have changed the transformation ratio at the test instrument, a message appears prompting you to change the setting at the current clamp sensor as well.																								
			$R_E$	<p>Voltage too high at clamp input or signal distorted The transformation ratio parameter selected at the test instrument might not correspond to the transformation ratio at the current clamp sensor. Remedy: Check transformation ratio or test setup.</p>																								
			All	<p>Battery voltage is less than or equal to 8 V. Reliable measurement is no longer possible. Storage of measured values to memory is disabled. Remedy: Rechargeable batteries must be recharged or replaced towards the end of their service life.</p>																								
			$I_{\Delta N} / I_F$	<p>Resistance in N-PE path is too high.</p> <table border="1" data-bbox="703 1653 1461 1769"> <thead> <tr> <th></th> <th colspan="5"><math>I_{\Delta N} / I_F</math></th> </tr> <tr> <th></th> <th>10 mA</th> <th>30 mA</th> <th>100 mA</th> <th>300 mA</th> <th>500 mA</th> </tr> </thead> <tbody> <tr> <td><math>R_{MAX}</math> at <math>I_{\Delta N}</math></td> <td>510 <math>\Omega</math></td> <td>170 <math>\Omega</math></td> <td>50 <math>\Omega</math></td> <td>15 <math>\Omega</math></td> <td>9 <math>\Omega</math></td> </tr> <tr> <td><math>R_{MAX}</math> for <math>I_F</math></td> <td>410 <math>\Omega</math></td> <td>140 <math>\Omega</math></td> <td>40 <math>\Omega</math></td> <td>12 <math>\Omega</math></td> <td>7 <math>\Omega</math></td> </tr> </tbody> </table> <p>Consequence: The required test current cannot be generated and measurement is aborted.</p>		$I_{\Delta N} / I_F$						10 mA	30 mA	100 mA	300 mA	500 mA	$R_{MAX}$ at $I_{\Delta N}$	510 $\Omega$	170 $\Omega$	50 $\Omega$	15 $\Omega$	9 $\Omega$	$R_{MAX}$ for $I_F$	410 $\Omega$	140 $\Omega$	40 $\Omega$	12 $\Omega$	7 $\Omega$
	$I_{\Delta N} / I_F$																											
	10 mA	30 mA	100 mA	300 mA	500 mA																							
$R_{MAX}$ at $I_{\Delta N}$	510 $\Omega$	170 $\Omega$	50 $\Omega$	15 $\Omega$	9 $\Omega$																							
$R_{MAX}$ for $I_F$	410 $\Omega$	140 $\Omega$	40 $\Omega$	12 $\Omega$	7 $\Omega$																							
			$Z_{L-PE}, R_E$	<p>If specified touch voltage <math>U_L</math> is exceeded:</p> <p><math>Z_{L-PE}</math> and <math>R_E</math>: User is prompted to switch to the 15 mA wave.</p> <p><math>R_E</math> alternative only: User is prompted to reduce the measuring range (reduce current.)</p>																								

Entry Plausibility Check – Parameters Combination Checking — LCD Pictographs

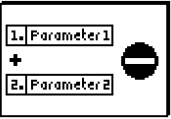
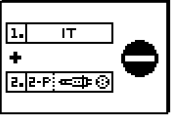
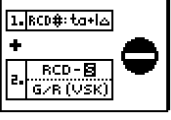

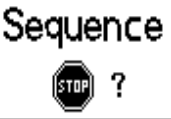
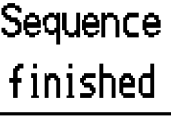

Status	Test Plug	Measuring Adapter	Function Switch Position	Function/Meaning
				Parameter out of range
			$I_{\Delta N}$	$5 \times 500 \text{ mA}$ is not possible
			$I_{\Delta N} / I_F \triangle$ EXTRA → ta + IΔ	Types B, B+ and EV/MI not possible with G/R, SRCD, PRCD
			$>I_{\Delta N}$	180° not possible for RCD-S, G/R, SRCD, PRCD-S, PRCD-K
			$I_{\Delta N} / I_F \triangle$	DC not possible with G/R, SRCD, PRCD
			$I_{\Delta N} / I_F \triangle$	Half-wave or DC not possible with type AC
			$I_{\Delta N} / I_F \triangle$ EXTRA → RCM	DC not possible with type A, F
			$I_{\Delta N}$ EXTRA → RCM	1/2 test current not possible with DC
			$I_{\Delta N}$	$2 \times I_{\Delta N} / 5 \times I_{\Delta N}$ with full-wave only
			$R_E$	DC+ with 10 Ω only
			$R_E$	No DC bias in the IT network
			$R_E$	15 mA only possible in 1 kΩ and 100 Ω ranges!
			EXTRA → RCM	With RCM: Types AC, F, B+ and EV/MI are not possible.
			$I_{\Delta N} / I_F \triangle$ EXTRA → RCM	Measurement with half-wave or DC is not possible in IT systems.

			All	The parameters you have selected do not make sense in combination with previously configured parameters. The selected parameter settings will not be saved. Remedy: Enter other parameters.
			R <sub>E</sub>	2-pole measurement via earthing contact plug is not possible in IT systems.
			EXTRA → ta+IA	The intelligent ramp is not possible with RCD types RCD-S and G/R.



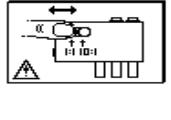



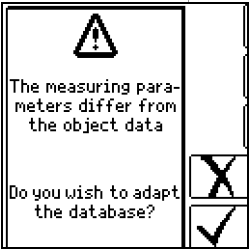

### Messages — LCD Pictographs — Test Sequences

Status	Test Plug	Measuring Adapter	Function Switch Position	Function/Meaning
			AUTO	The test sequence includes a measurement which cannot be processed by the connected test instrument. The corresponding test step must be skipped. Example: The test sequence includes an RCM measurement which has been sent to the PROFITEST MTECH+.
			AUTO	The test sequence has been run successfully.
			AUTO	No test sequences have been saved. Cause: These may have been deleted as a result of any of the following actions: changing the language, the profile or the DB mode, or resetting the test instrument to its default settings.

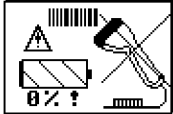
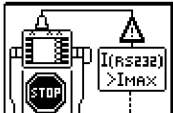
### Error Messages — LCD Pictographs — PRO-AB Leakage Current Measuring Adapter

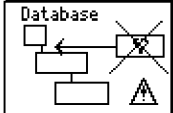
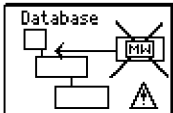
Status	Test Plug	Measuring Adapter	Function Switch Position	Function/Meaning
			EXTRA → I <sub>L</sub>	Measuring range exceeded Change to the larger measuring range (test instrument and leakage current measuring adapter).
			EXTRA → I <sub>L</sub>	Test measurement: The test has been passed. The leakage current measuring adapter is now ready for use.
			EXTRA → I <sub>L</sub>	Test measurement: The test has not been passed. The leakage current measuring adapter is defective. Contact our repair service department.
			EXTRA → I <sub>L</sub>	Test measurement: Check the fuse in the leakage current measuring adapter.



	$\frac{I_{AN}}{I_F} \triangle$ $\frac{Z_{L-N}}{Z_{L-PE}}$ <p>EXTRA → <math>t_A + I_{\Delta}</math> EXTRA → RCM</p>	<p><b>Measured Value Storage with Deviating Electrical Circuit Parameter</b></p> <p>The electrical circuit parameter selected by yourself at the test instrument does <b>not</b> coincide with the parameter entered under object data in the structure.</p> <p><b>Example:</b> Residual operating current is specified as 10 mA in the database, but you have performed measurement with 100 mA. If you want to perform all future measurements with 100 mA, the value in the database has to be changed by acknowledging with the <input checked="" type="checkbox"/> key. The measured value is documented and the new parameter is accepted.</p> <p>If you want to leave the parameter in the database unchanged, press the <input type="checkbox"/> key. The measured value and the changed parameter are only documented in this case.</p>
	All	Please enter a designation (alphanumeric).
	All	<p>Operation with a Barcode Scanner</p> <p>Error message when the "EDIT" entry field is opened and rechargeable battery voltage is less than 8 V. Output voltage is generally switched off during barcode scanner operation if U is less than 8 V in order to assure that remaining battery capacity is adequate for entering designations for devices under test and saving the measurement.</p> <p>Remedy: Rechargeable batteries must be recharged or replaced towards the end of their service life.</p>
	All	<p>Operation with a Barcode Scanner</p> <p>Current flowing through the RS 232 port is too high.</p> <p>Remedy: The connected device is not suitable for this port.</p>
	All	<p>Operation with a Barcode Scanner</p> <p>Barcode not recognized, incorrect syntax.</p>
	All	<p>Data cannot be entered at this location within the structure.</p> <p>Remedy: Observe profile for preselected PC software (see <b>SETUP</b> menu in section 8).</p>
	All	<p>Measured value cannot be saved at this location within the structure.</p> <p>Remedy: Make sure that you have selected the right profile for you PC evaluation program in the <b>SETUP</b> menu (see section 8).</p>
	All	<p>Memory is full.</p> <p>Remedy: Save your measurement data to a PC and then clear memory at the test instrument by deleting the database or by importing an empty database.</p>
	All	<p>Delete measurement or database elements.</p> <p>This prompt window asks you to confirm deletion (YES).</p>
	SETUP	<p><b>Attention!</b> <b>Data loss after restoring default settings!</b></p> <p>Back up your measurement data to a PC before pressing the respective key.</p> <p>This prompt window asks you to confirm deletion.</p>

## 7 Operation



### Attention!

The protective foil on the two sensor surfaces (finger contacts) of the test plug must be removed to ensure reliable detection of touch voltages.

### 7.1 Power Supply

The instrument is powered by rechargeable batteries. The included Master Battery Pack (Z502H) or commercially available individual rechargeable or regular batteries can be used.



### Note

If at all possible use the included battery pack (Z502H) with sealed cells. This ensures that the complete set of rechargeable batteries is always replaced at the same time and that all batteries are inserted with correct polarity, in order to assure that they do not fail.

The included Z502H battery pack has already been inserted during initial startup (see condensed operating instructions).

#### 7.1.1 Inserting or Replacing the Battery Pack (Z502H) or Commercially Available Individual (Rechargeable) Batteries



### Attention!

Before opening the battery compartment, disconnect the instrument from the measuring circuit (mains) at all poles!



### Attention!

Commercially available, individual rechargeable or regular batteries must comply with the technical data (see page 10).

- ⇨ Loosen the slotted screw for the rechargeable battery compartment lid on the back and remove the lid.
- ⇨ Remove the depleted battery pack or commercially available rechargeable or regular batteries.
- ⇨ Insert the battery pack or commercially available rechargeable or regular batteries into the battery compartment.



### Attention!

In the case of commercially available, individual rechargeable or regular batteries: make sure that all of the batteries are inserted with correct polarity. If just one battery is inserted with reversed polarity, it will not be recognized by the instrument and may result in leakage from the batteries and damage to the instrument.

- ⇨ Replace the lid and retighten the screw.



### Note

Dispose of the battery pack or commercially available, individual rechargeable or regular batteries in an environmentally sound fashion when their service life has nearly expired (approx. 80% charging capacity). See section 24, "Disposal and Environmental Protection", on page 99.

#### 7.1.2 Charging the Battery Pack (Z502H) in the Tester



### Attention!

If commercially available, individual rechargeable batteries are used, they must be charged externally. Do not use the Z502R charger to charge commercially available individual batteries. The quality of commercially available, individual rechargeable batteries cannot be checked and may result in overheating and thus deformation and explosion when charging them in the instrument.



### Attention!

If commercially available, individual rechargeable batteries are used, they must be charged externally. Do not use the Z502R charger to charge commercially available individual batteries.

The quality of commercially available, individual rechargeable batteries cannot be checked and may result in overheating and thus deformation and explosion when charging them in the instrument.



### Attention!

Regular batteries may not be charged.



### Attention!

Use only the Z502R charger in order to recharge the Compact Battery Pack (Z502H) in the test instrument.



### Attention!

The Z502R charger is suitable for mains operation only!



### Attention!

Do not switch the test instrument on during charging. The charging process may otherwise be impaired.

- ⇨ Verify that the battery pack (Z502H) is inserted, i.e. that commercially available battery packs or batteries are not inserted.
- ⇨ Insert the correct mains plug for your country into the charger Z502R.
- ⇨ Connect the Z502R charger to the test instrument with the jack plug, and then to the 230 V mains with the interchangeable plug.
- ⇨ Do not disconnect the charger from the test instrument until the green LED (charged/ready) lights up.

#### If the rechargeable batteries or battery pack have not been used or recharged for a lengthy period of time (> 1 month), thus resulting in excessive depletion:

Observe the charging sequence (indicated by LEDs at the charger) and initiate a second charging sequence if necessary (disconnect the charger from the mains and from the test instrument to this end, and then reconnect it).

Please note that the system clock stops in this case and must be set to the correct time after the instrument has been restarted.

### 7.2 Switching the Instrument On/Off

The test instrument is switched on by pressing the **ON/START** key. The menu which corresponds to the momentary selector switch position is displayed.

The instrument can be switched off manually by simultaneously pressing the **MEM** and **HELP** keys.

After the period of time selected in the **SETUP** menu has elapsed, the instrument is switched off automatically (see "Device Settings", section 8).

#### Battery Test

A battery test is performed after switching the instrument on.

If supply voltage has fallen below the permissible lower limit, the pictograph shown at the right appears. **BAT** 

"Low Batt!!!" is also displayed along with an icon.

The instrument does not function if the batteries have been depleted excessively, and no display appears.

Ensure adequate power supply by charging the rechargeable battery pack (Z502H) or by inserting fully charged, commercially available rechargeable batteries or new batteries. See section 7.1, "Power Supply", on page 26.

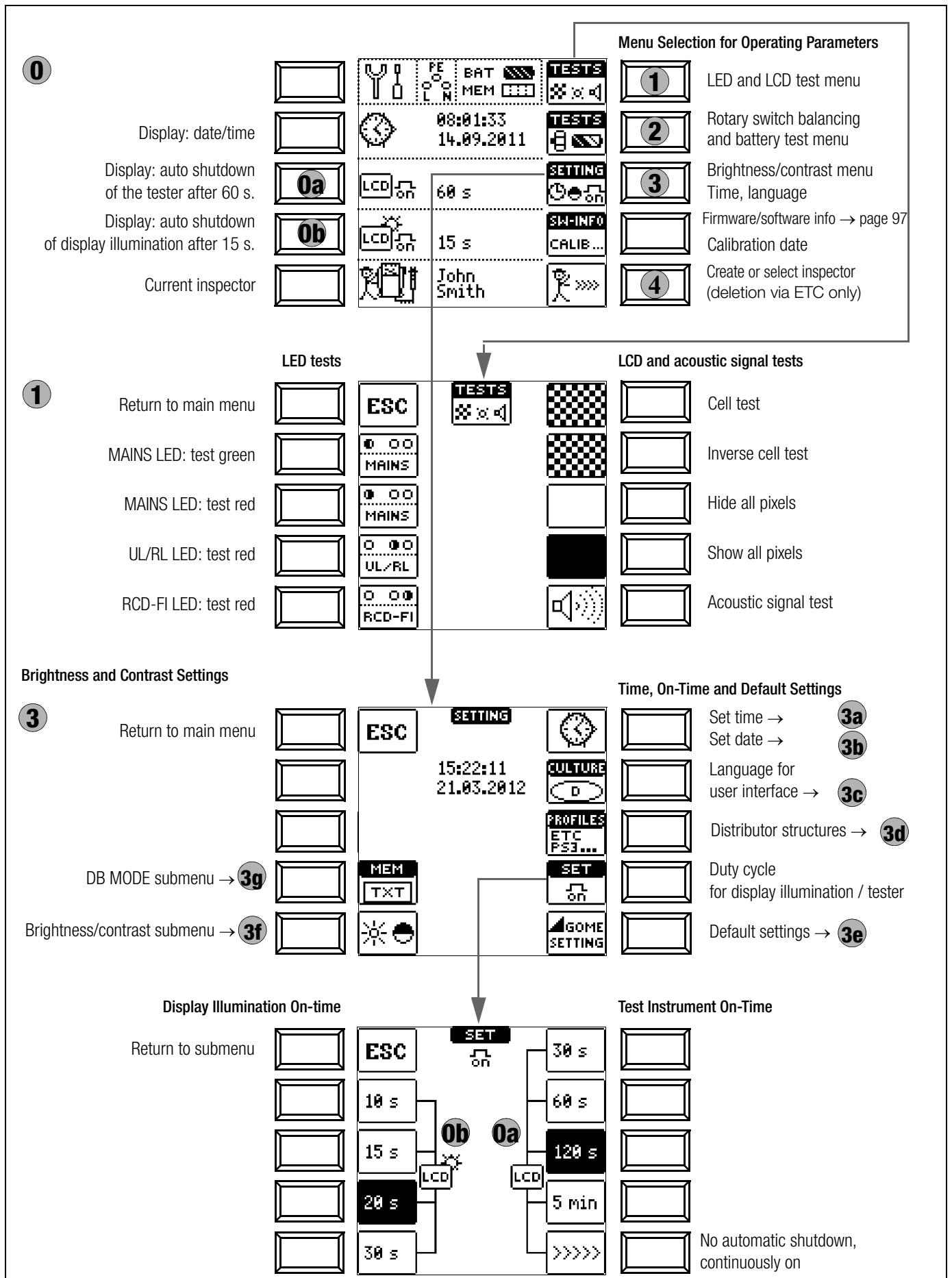

0

Display: date/time

Display: auto shutdown of the tester after 60 s.

Display: auto shutdown of display illumination after 15 s.

Current inspector

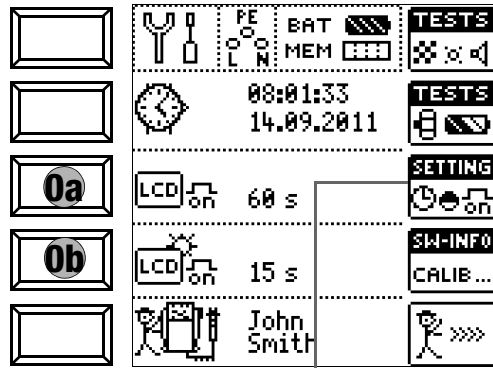

### Menu Selection for Operating Parameters

- 1 LED and LCD test menu
- 2 Rotary switch balancing and battery test menu
- 3 Brightness/contrast menu  
Time, language
- Firm/software info → page 97
- Calibration date
- 4 Create or select inspector  
(deletion via ETC only)

### Brightness and Contrast Settings

3

Return to main menu

DB MODE submenu → 3g

Brightness/contrast submenu → 3f

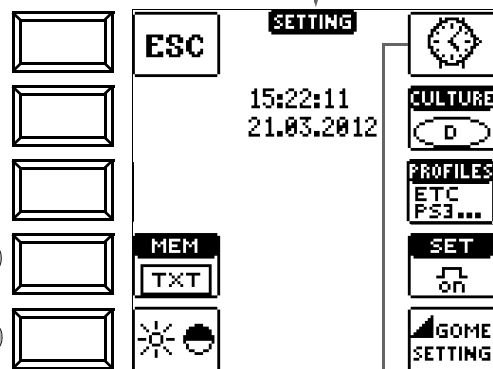

### Set Time, Language, Acoustic Signal

- Set time → 3a
- Set date → 3b
- Language for user interface → 3c
- Distributor structures → 3d
- Duty cycle for display illumination / tester
- Default settings → 3e

3a

Return to submenu

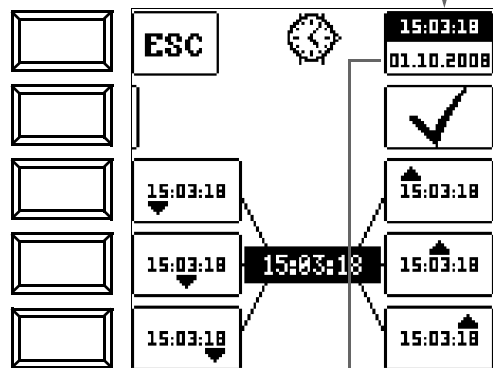

### Set time

- Select time
- Apply settings
- Increase hours
- Decrease hours
- Increase minutes
- Decrease minutes
- Increase seconds
- Decrease seconds

3b

Return to submenu

Increase day

Increase month

Increase year

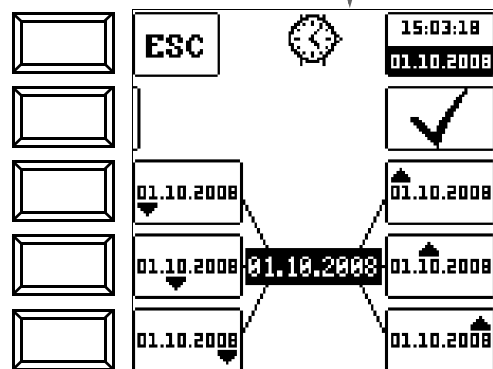

### Set date

- Select date
- Apply settings
- Decrease day
- Decrease month
- Decrease year

## Significance of Individual Parameters

### 0a Test Instrument On-Time

The period of time after which the test instrument is automatically shut off can be selected here. This selection has a considerable influence on the service life and the charging status of the batteries.

### 0b LCD Illumination On-Time

The period of time after which LCD illumination is automatically shut off can be selected here. This selection has a considerable influence on the service life and the charging status of the batteries.

### 2 Submenu: Rotary Switch Balancing

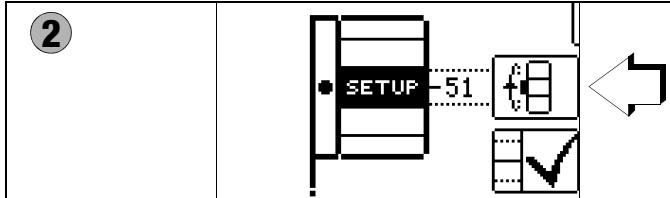

Proceed as follows in order to precision adjust the rotary switch:

- 1 Press the **TESTS** Rotary Switch / Battery Test softkey in order to access the rotary switch balancing menu.
- 2 Then press the softkey with the rotary switch icon.
- 3 Make sure that the rotary switch is set to **SETUP**.  
The level mark to the left of the number should be aligned to the black function field with the respective rotary switch designation. The value of the number can be displayed within a range of -1 to 101 and should be between 45 and 55. In the case of -1 or 101, the rotary switch position does not match the measuring function shown at the display.  
If the displayed value is not within this range, readjust the position by pressing the **readjust** softkey . A brief acoustic signal acknowledges readjustment.

#### Note

If labeling in the LCD image of the rotary switch does not correspond with its actual position, a continuous acoustic signal is generated as a warning when the **readjust** softkey is pressed.

- 4 Acknowledge by pressing the softkey with the rotary switch icon. The display is then switched to the next measuring function.
- 5 Turn the rotary switch clockwise to the next measuring function (after **SETUP** comes **I<sub>AN</sub>**).
- 6 Repeat steps 3 through 5 until all rotary switch functions have been tested, and if necessary readjusted.
- 7 Press **ESC**, in order to return to the main menu.

### 2 Submenu: Battery Level Query

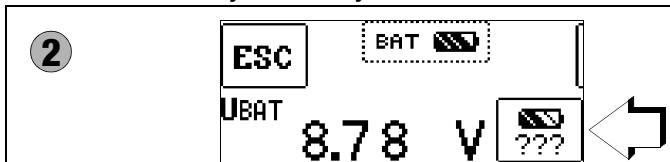

If battery voltage has dropped to 8.0 V or less, the **UL/RL LED** lights up red and an acoustic signal is generated as well.

#### Note

##### Measuring Procedure

If battery voltage drops to below 8.0 V during the course of a measuring sequence, this is only indicated by means of a pop-up window. Measured values are invalid. The measurement results cannot be saved to memory.



- ⇨ Press **ESC** in order to return to the main menu.

### 3c User Interface Language (CULTURE)

- ⇨ Select the desired country setup with the appropriate country code.



#### Attention!

**All structures, data and sequences are deleted when the language is changed!**

Back up your structures, measurement data and sequences to a PC before pressing the key. The prompt window shown at the right asks you to confirm deletion.



### 3d Profiles for Distributor Structures (PROFILES)

The profiles are laid out in a tree structure. The tree structure for the utilized PC evaluation program may differ from that of the PROFITEST MASTER. For this reason, the PROFITEST MASTER provides the user with the opportunity of adapting this structure.

Selecting a suitable profile determines which object combinations are made possible. For example, this makes it possible to create a distributor which is subordinate to another or to save a measurement to a given building.

- ⇨ Select the PC evaluation program you intend to use.

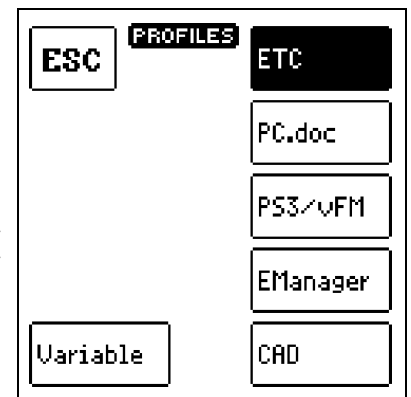

#### Attention!

**All structures, data and sequences are deleted when the profile is changed!**

Back up your structures, measurement data and sequences to a PC before pressing the key. The prompt window shown at the right asks you to confirm deletion.



If you haven't selected a suitable PC evaluation program and, for example, if measured value storage to the selected location within the structure is not possible, the pop-up window shown at the right appears.

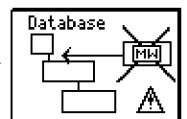

### 3e Default Settings (GOME SETTING)

The test instrument is returned to its original default settings when this key is activated.



#### Attention!

**All structures, data and sequences are deleted!**

**Back up your structures, measurement data and sequences to a PC before resetting.**

### 3f Adjusting Brightness and Contrast

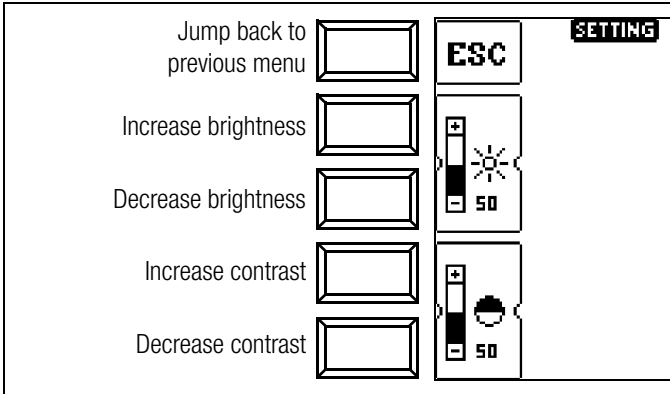

### 3g DB-MODE – Display of the Database in the Text or ID Mode

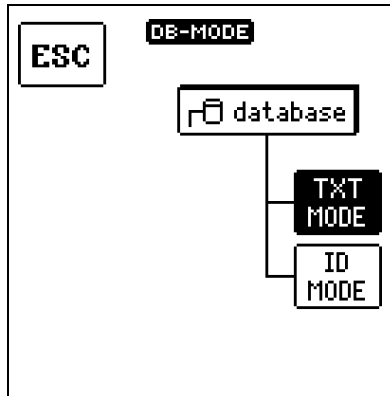

#### Creating Structures in the TXT MODE

The database in the test instrument is set to the text mode as a default feature and “TXT” appears in the header. You can create structure elements in the test instrument and label them in plain text, e.g. Customer XY, Distributor XY and Circuit XY.

#### Creating Structures in the ID MODE

You can work in the ID MODE as an alternative, in which case “ID” appears in the header. You can create structure elements in the test instrument and label them with any desired ID numbers.



#### Note

Structures can be created in the test instrument in either the text mode or the ID mode. In contrast to this, designations and ID numbers are always assigned in the report generating program.

If no texts or ID numbers have been entered to the test instrument when creating structures, the report generating program creates the missing entries automatically. These can then be edited in the report generating program and transferred back to the test instrument if required.

### 4 Selecting, Adding or Deleting an Inspector

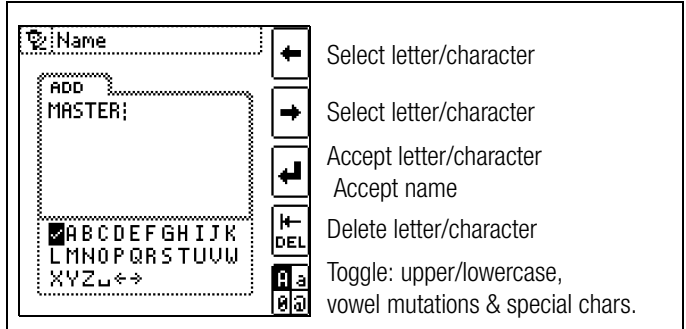
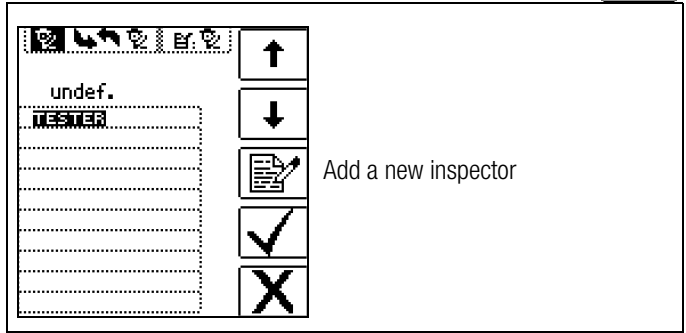

See also section 10.8 on page 39 regarding the entry of a text.

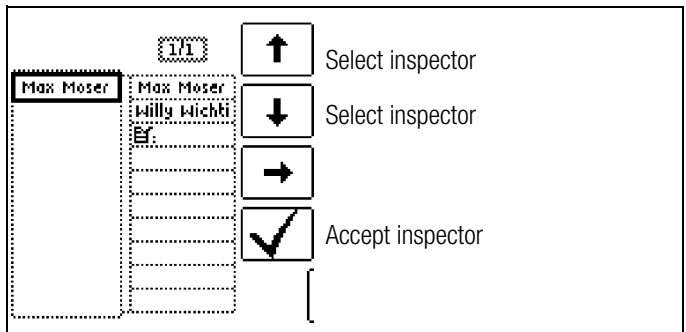

(delete inspector via ETC only)



#### Note

The inspector cannot be changed. If an inspector’s name is incorrect, it can be deleted and a new inspector can be created with the correct name. Changes are not retroactive. Deleted inspectors are retained for tests which have already been performed.

## 9 Database

### 9.1 Creating Distributor Structures, General

A complete distributor structure with data for electrical circuits and RCDs can be created in the test instrument. This structure makes it possible to assign measurements to the electrical circuits of various distributors, buildings and customers.

There are two possible procedures:

- On location or at the construction site: create a distributor structure in the test instrument. A distributor structure with up to 50,000 structure elements can be created in the test instrument, which is saved to the instrument's flash memory.

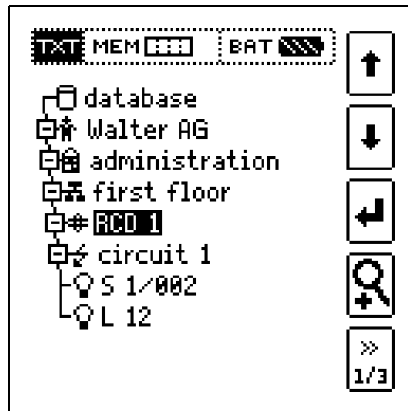

or

- Create and save an image of an existing distributor structure at a PC with the help of ETC report generating software (Electric Testing Center) – see Help > Getting Started (F1). The distributor structure is then transferred to the test instrument.

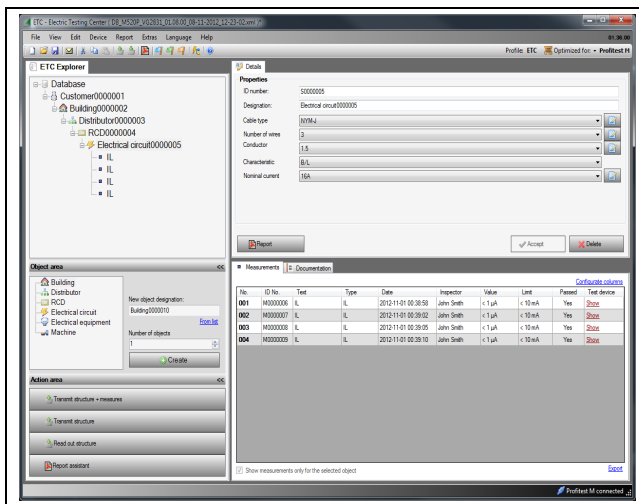

#### Notes regarding ETC

The following steps must be completed before using the software:

- Install the USB device driver (required for operation of the test instrument at a PC): GMC-I Driver Control software for installing the USB device driver can be downloaded from our website: <https://www.gmc-instruments.de/services/download-center/>
- Install ETC report generating software: The most up-to-date version of ETC can be downloaded free of charge from the mygmc page of our website as a ZIP file, if you have registered your test instrument: <https://www.gmc-instruments.de/services/mygmc/>

### 9.2 Transferring Distributor Structures

The following data transfer operations are possible:

- Transfer a distributor structure from the PC to the test instrument.
- Transfer a distributor structure including measured values from the test instrument to the PC.

The test instrument and the PC must be connected with a USB cable in order to transfer structures and data.



#### Note

The rotary selector switch may not be set to the “U” position during data transmission.

The following image appears at the display during transfer of structures and data.

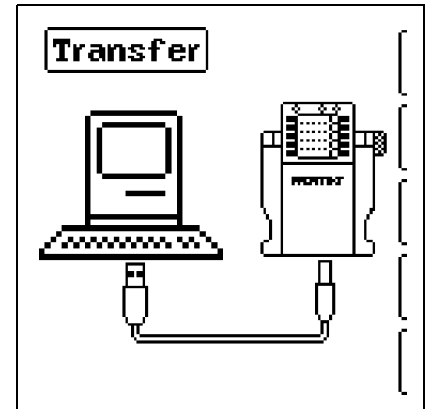

### 9.3 Creating a Distributor Structure in the Test Instrument

#### Overview of the Meanings of Icons used to Create Structures

Icons	Meaning
Main level	Sublevel
	<b>Memory Menu, Page 1 of 3</b>
	Cursor UP: scroll up
	Cursor DOWN: scroll down
	ENTER: Acknowledge selection. + → - change to sub-level (expand directory) or - → + change to main level (close directory)
	Display the complete structure designation (max. 63 characters) or ID number (25 characters) in a zoom window.
	Temporarily switch back and forth between structure designation and ID number. These keys don't have any effect on the main setting in the setup menu (see “DB Mode” on page 30).
	Hide the zoom window
	Change display to menu selection
	<b>Memory Menu, Page 2 of 3</b>
	Add a structure element

Icons	Meaning
	<p>Meanings of icons from top to bottom:  Customer, building, distributor, RCD, electrical circuit, operating equipment, machine and earth electrode (display of the icons depends on the selected structure element).  Selection: UP/DOWN scroll keys and ↵  In order to add a designation to the selected structure element, refer to the edit menu in following column.</p>
	Delete the selected structure element.
	Show measurement data, if a measurement has been performed for this structure element.
	Edit the selected structure element.
<b>Memory Menu, Page 3 of 3</b>	
	Search for ID number. > Enter complete ID number.
	Search for text. > Enter full text (complete word).
	Search for ID number or text.
	Continue searching.
<b>Edit menu</b>	
	Cursor LEFT: Select an alphanumeric character.
	Cursor RIGHT: Select an alphanumeric character.
	ENTER: accept an individual character.
<input checked="" type="checkbox"/>	Acknowledge entry
←	Scroll left
→	Scroll right
	Delete character
	Switching amongst different types of alphanumeric characters:
A	<input checked="" type="checkbox"/> ABCDEFGHIJK Upper case letters LMNOPQRSTUVWXYZ XYZ↵↔
a	<input checked="" type="checkbox"/> abcdefghijk Lower case letters lmnopqrstuvwxyz xyz↵↔
0	<input checked="" type="checkbox"/> 0123456789+ Numbers -*/=:,:-(<> .!?↵↔
@	<input checked="" type="checkbox"/> @äAöÜÜ€\$% Special characters &#ääëiïöü ñÄæ↵↔

## Distributor Structure Symbology / Tree Structure

A check mark to the right of a structure element means that all measurements within the respective hierarchy have been passed.  
x: at least one measurement has not been passed.  
No symbol: measurement has not yet been performed.

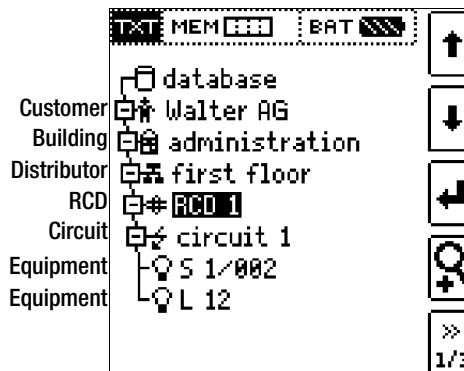

Same type of element as in the Windows Explorer:  
+: sub-objects available, display by pressing ↵.  
-: sub-objects are displayed, hide by pressing ↵.



### 9.3.1 Creating Structures (example for electrical circuit)

After selection with the **MEM** key, all setting options for the creation of a tree structure are made available on three menu pages (1/3, 2/3 and 3/3). The tree structure consists of structure elements, referred to below as objects.

#### Selecting the Position at which a New Object will be Added

The screenshot shows a menu with a tree structure. The tree has the following levels: 'database', 'Walter AG', 'administration', 'first floor', 'RCD 1', 'circuit 1', 'S 1/002', and 'L 12'. To the right of the tree are five navigation buttons: an up arrow (labeled 'Scroll up'), a down arrow (labeled 'Scroll down'), a left arrow (labeled 'Confirm selection / change level'), a magnifying glass (labeled 'Display object or ID number'), and a right arrow (labeled 'Next page'). The page indicator '1/3' is at the bottom left.

Use the  $\uparrow\downarrow$  keys in order to select structure elements. Change to the sub-level with the  $\leftarrow$  key. Go to the next page with the  $\gg$  key

#### Creating a New Object

The screenshot shows the same tree structure as before. The 'Create object' option is highlighted. To the right of the tree are four action buttons: a plus sign (labeled 'Create object'), a pencil (labeled 'Edit designation'), a magnifying glass (labeled 'VΩA: Show measurement data'), and a trash can (labeled 'Delete object'). The page indicator '2/3' is at the bottom left.

Press the key in order to create a new object.

#### Select a new object from a list.

The screenshot shows the tree structure with a list of objects displayed in a separate window. The list contains several items, including 'S 1/002' and 'L 12'. To the right of the list are three navigation buttons: an up arrow (labeled 'Scroll up'), a down arrow (labeled 'Scroll down'), and a left arrow (labeled 'Confirm selection').

Select the desired object from the list with the  $\uparrow\downarrow$  keys and acknowledge with the  $\leftarrow$  key.

Depending upon the profile selected in the test instrument's **SETUP** menu (see section 8), the number of object types may be limited, and the hierarchy may be laid out differently.

#### Entering a Designation

The screenshot shows a character selection menu. At the top, it says 'Database'. Below that, there is a field for 'ADD circuit 21'. To the right of the field are several navigation buttons: a left arrow (labeled 'Select character'), a right arrow (labeled 'Select character'), a left arrow with a checkmark (labeled 'Accept character'), a checkmark (labeled 'Save object designation'), a left arrow (labeled 'Delete character'), and a 'DEL' button. Below the field is a numeric keypad and a character selection list: '0 1 2 3 4 5 6 7 8 9 +', '- \* / = : ; , - ( ) < >', and '! ? \_ @'. The page indicator '1/3' is at the bottom left.

Enter a designation and then acknowledge it with  $\checkmark$ .



#### Note

Acknowledge your entry with  $\checkmark$  and  $\leftarrow$ , because the entry will otherwise not be accepted.

#### Entering a Comment

Enter a comment and then acknowledge it with  $\checkmark$ .



#### Note

Acknowledge your entry with  $\checkmark$  and  $\leftarrow$ , because the entry will otherwise not be accepted.

#### Setting Electrical Circuit Parameters

The screenshot shows a menu for setting electrical circuit parameters. It has a table of parameters with 'IN' values ranging from 2.0A to 25A. To the right of the table are four navigation buttons: an up arrow (labeled 'Select parameter'), a down arrow (labeled 'Select parameter setting'), a right arrow (labeled 'Parameter settings list'), and a checkmark (labeled 'Acknowledge parameter selection and return to page 1/3 in the database menu.').

For example, nominal current values must be entered here for the selected electrical circuit. Measuring parameters which have been accepted and saved in this way are subsequently accepted by the current measuring menu automatically when the display is switched from the structure view to measurement.



#### Note

Electrical circuit parameters changed during structure creation are also retained for individual measurements (measurement without saving data).

**If you change the electrical circuit parameters specified by the structure in the test instrument, a warning is displayed when the change is saved (see error message on page 25).**

### 9.3.2 Searching for Structure Elements

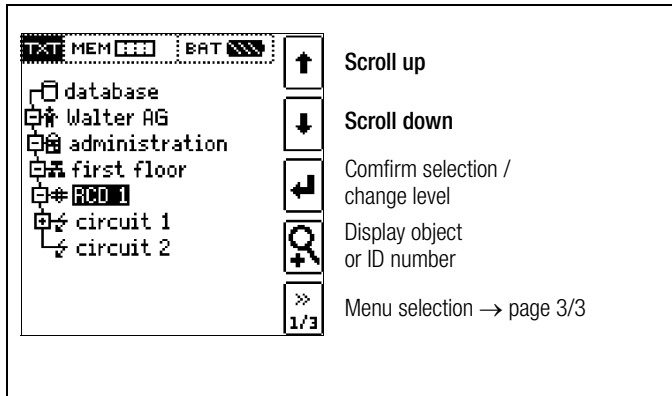

Regardless of the currently selected object, the search is started at **database**.

Go to page **3/3** in the database menu.

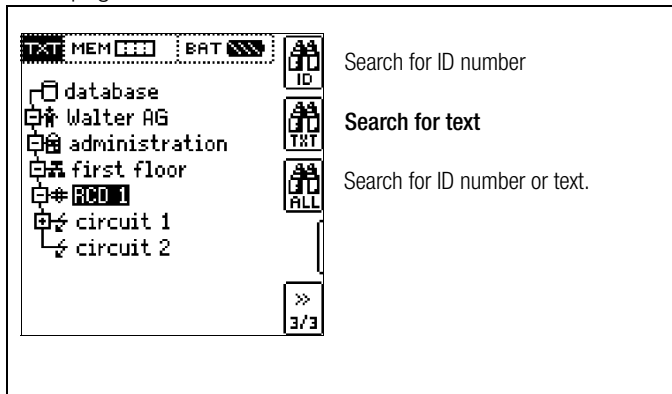

After selecting text search...

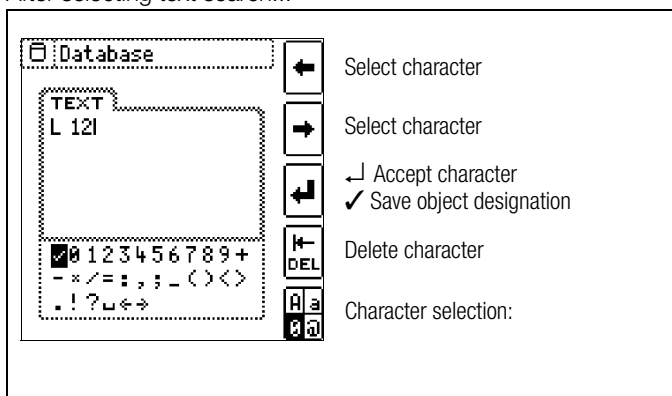

... and entering the desired text (only full matches are found – no wild cards, case sensitive) ...

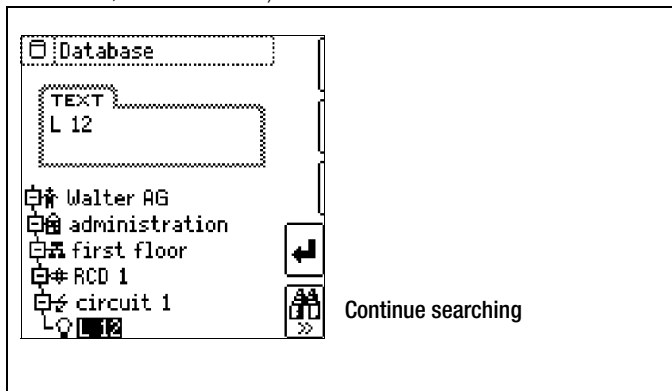

... the first match is displayed.

Further matches can be found by selecting the icon shown at the right ...

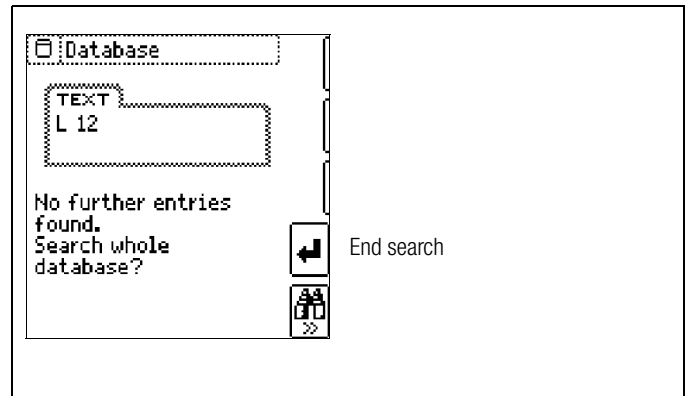

If no further matches are found, the message shown above is displayed.

### 9.4 Saving Data and Generating Reports

#### Preparing and Executing a Measurement

Measurements can be performed and stored to memory for each structure element. Proceed as follows, adhering to the prescribed sequence:

- Select the desired measurement with the rotary knob.
  - Start the measurement by pressing the **ON/START** ▼ or **I<sub>AN</sub>** key.
- Upon completion of measurement, the → **Floppy Disk** softkey is displayed.
- **Briefly** press the **Save Value** key.



The display is switched to the memory menu or the structure view.

- Navigate to the desired memory location, i.e. to the desired structure element / object, for which the measurement data will be saved.
- If you would like to save a comment along with the measurement, press the key shown at the right and enter a designation via the "EDIT" menu as described in section 9.3.1.
- Complete data storage by pressing the "STORE" key.



#### Saving Error Messages (pop-ups)

If a measurement is ended without a measured value due to an error, the measurement can be saved along with the pop-up by pressing the "Save Value" key. The corresponding text is read out in ETC instead of the pop-up symbol. This only applies to a limited number of pop-ups (see below). Neither a symbol nor a text can be accessed in the test instrument's database itself.

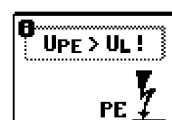
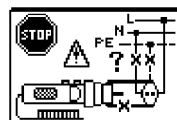
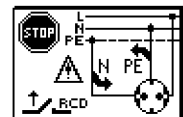
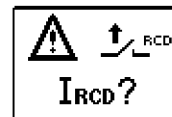
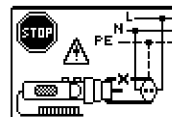

#### Alternative Storage Procedure

- The measured value can be saved to the last selected object in the structure diagram by **pressing and holding** the **Save Value** key, without switching the display to the memory menu.







### Note

If you change the parameters in the measurement view, they're not saved for the structure element. A measurement with changed parameters can nevertheless be saved to the structure element, and any changed parameters are documented in the report for each measurement.

### Retrieving Saved Measured Values

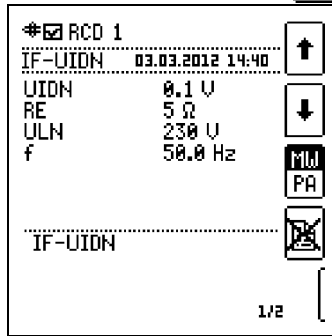

- Switch the display to the distributor structure by pressing the **MEM** key and select the desired electrical circuit with the scroll keys.
- Switch to page 2 by pressing the key shown here: 
- Display the measurement data by pressing the key shown here: 

One measurement with date and time, as well as any comment you might have entered, is displayed in each screen. Example: RCD Measurement



### Note

A check mark in the header means that the respective measurement has been passed. An X means that the measurement has not been passed.

- Scrolling amongst measurements is possible with the keys shown here: 
- The measurement can be deleted with the key shown here: 

A prompt window asks you to confirm deletion.



With the help of the key shown at the right (MW: measured value / PA: parameter), the setting parameters can be displayed for this measurement. 

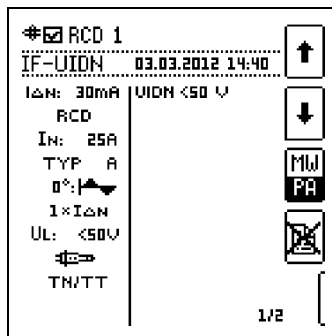

- Scrolling amongst measurements is possible with the keys shown here: 

### Data Evaluation and Report Generation with the Report Generating Program

All data, including the distributor structure, can be transferred to the PC and evaluated with the help of the report generating program. Additional information can be entered here subsequently for the individual measurements. After pressing the appropriate key, a report including all measurements within a given distributor structure is generated, or the data are exported to an Excel spreadsheet.



### Note

The database is exited when the rotary selector switch is turned. Previously selected parameters in the database are not used for the measurement.

### 9.5 Use of Barcode Scanners and RFID Readers

#### Search for an Already Scanned Barcode

The search can be started from any switch setting and menu.

- Scan the object's barcode.
- The recognized barcode is displayed inversely.
- This value is accepted after pressing the **ENTER** key.



### Note

A previously selected object is not taken into consideration by the search.

#### Continued Searching in General

Regardless of whether or not an object has been found, searching can be continued by pressing the key shown at the right: 

- Object found: Searching is continued below the previously selected object.
- Further object found: The entire database is searched at all levels.

#### Reading In a Barcode for Editing

If the menu for alphanumeric entry is active, any value scanned by means of a barcode or RFID reader is accepted directly.

#### Using a Barcode Printer (accessory)

The following functions are made possible with the help of a barcode printer:

- Read-out of ID numbers as barcodes – for quick and convenient acquisition for periodic testing
- Print out repeatedly occurring designations such as test object types encrypted as barcodes in a list, allowing them to be read in as required for comments

## 10 General Information on Measurements

### 10.1 Using Cable Sets and Test Probes

- Scope of delivery: 2-pole measuring adapter and cable for expansion into a 3-pole adapter (PRO-A3-II/)
- Optional accessory: PRO-RLO II (Z501P) 2-pole measuring adapter with 10 m cable
- Optional accessory: KS24 cable set (GTZ3201000R0001)

Measurements per DIN EN 61010-031 may only be performed in environments in accordance with measuring categories III and IV with the safety cap attached to the test probe at the end of the measurement cable.

In order to establish contact inside 4 mm jacks, the safety caps have to be removed by prying open the snap fastener with a pointed object (e.g. the other test probe).



#### Attention!

Grip and hold the test plug and test probes securely when they have been inserted, for example, into a socket. Danger of injury exists if tugging at the coil cord occurs, which may cause the test plug or test probes to snap back.

### 10.2 Test Plug – Changing Inserts

The test plug can be fitted with various inserts (e.g. two-pole measuring adapter or country-specific plug insert).

In order to change inserts, unscrew the retaining ring until you can pull out the currently used insert. Then mount the desired insert and retighten the retaining ring.

(See overview in section 5.4 on page 8.)

### 10.3 Connecting the Instrument

For systems with earthing contact sockets, connect the instrument to the mains with the test plug to which the appropriate, country-specific plug insert is attached. Voltage between phase conductor L and protective conductor PE may not exceed 253 V! Poling at the socket need not be taken into consideration. The instrument detects the positions of phase conductor L and neutral conductor N, and automatically reverses polarity if necessary. This does not apply to the following measurements:

- Voltage measurement in switch position U
- Insulation resistance measurement
- Low-resistance measurement

The positions of phase conductor L and neutral conductor N are identified on the plug insert.

If measurement is to be performed at three-phase outlets, at distribution cabinets or at permanent connections, the measuring adapter must be attached to the test plug. Connection is established with the test probes: one at PE or N and the other at L.

The 2-pole measuring adapter must be expanded to 3 poles with the included measurement cable for the performance of phase sequence testing.

Touch voltage (during RCCB testing) and earthing resistance can be, and earth-electrode potential, standing surface insulation resistance and probe voltage must be measured with a probe. The probe is connected to the probe connector socket with a 4 mm contact-protected plug.

### 10.4 Automatic Settings, Monitoring and Shutdown

The test instrument automatically selects all operating conditions which it's capable of determining itself. It tests line voltage and frequency. If these lie within their valid nominal ranges, they appear at the display panel. If they are not within nominal ranges, prevailing voltage (U) and frequency (f) are displayed instead of  $U_N$  and  $f_N$ .

**Touch voltage** which is induced by test current is monitored for each measuring sequence. If touch voltage exceeds the limit value of  $> 25\text{ V}$  or  $> 50\text{ V}$ , measurement is immediately interrupted. The  $U_L/R_L$  LED lights up red.

If **battery voltage** falls below the permissible limit value the instrument cannot be switched on, or it is immediately switched off.

The measurement is interrupted automatically, or the measuring sequence is blocked (except for voltage measuring ranges and phase sequence testing) in the event of:

- Impermissible line voltages ( $< 60\text{ V}$ ,  $> 253\text{ V}$  /  $> 330\text{ V}$  /  $> 440\text{ V}$  or  $> 550\text{ V}$ ) for measurements which require line voltage
- Interference voltage during insulation resistance or low resistance measurements
- Overheating at the instrument  
As a rule, excessive temperatures only occur after approximately 50 measurement sequences at intervals of 5 seconds, when the rotary selector switch is set to the  $Z_{L-PE}$  or  $Z_{L-N}$  position.  
If an attempt is made to start a measuring sequence, an appropriate message appears at the display panel.

The instrument only switches itself off automatically after completion of an automatic measuring sequence, and after the predetermined on-time has expired (see section 7.2). On-time is reset to its original value as defined in the setup menu, as soon as any key or the rotary selector switch is activated.

The instrument remains on for approximately 75 s in addition to the preset on-time for measurements with rising residual current in systems with selective RCDs.

The instrument always shuts itself off automatically!

### 10.5 Measured Value Display and Memory

The following items appear at the display panel:

- Measured values with abbreviations and units of measure
- Selected function
- Nominal voltage
- Nominal frequency
- Error messages

Measured values for automatic measuring sequences are stored and displayed as digital values until the next measurement sequence is started, or until automatic shutdown occurs.

If the upper range limit is exceeded, the upper limit value is displayed and is preceded by the ">" symbol (greater than), which indicates measurement value overrun.



#### Note

The depiction of LEDs in these operating instructions may vary from the LEDs on the actual instrument due to product improvements.

#### Testing Earthing Contact Sockets for Correct Connection

The testing of earthing contact sockets for correct connection prior to protective measures testing is simplified by means of the instrument's error detection system.

The instrument indicates improper connection as follows:

- **Impermissible line voltage ( $< 60\text{ V}$  or  $> 253\text{ V}$ ):**  
The MAINS/NETZ LED blinks red and the measuring sequence is disabled.
- **Protective conductor not connected or potential to earth  $\geq 50\text{ V}$  at  $\geq 50\text{ Hz}$  (switch position U – single-phase measurement):**  
If the contact surfaces are touched (**finger contact\***) while PE is being contacted (via the country-specific plug insert, e.g. SCHUKO, as well as via the PE test probe at the 2-pole adapter) PE appears (only after a test sequence has been started). The  $U_L/R_L$  and RCD/FI LEDs light up red as well.

\* For reliable detection of touch voltages, both sensor surfaces on the test plug must be touched with unprotected fingers/palm, i.e. with direct skin contact (see also section 7).

- **Neutral conductor N not connected** (during mains dependent measurements):  
The MAINS/NETZ LED blinks green.
- **One of the two protective contacts is not connected:**  
This is checked automatically during testing for touch current  $U_{I\Delta N}$ . Poor contact resistance at one of the contacts leads to

one of the following displays depending upon poling of the plug:

– **Display at the connection pictograph:**

PE interrupted (x), or underlying protective conductor bar interrupted with reference to the keys at the test plug

**Cause:** Voltage measuring path interrupted  
**Consequence:** measurement is disabled

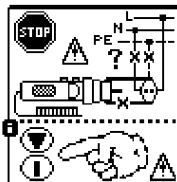

– **Display at the connection pictograph:**

Top protective conductor bar interrupted with reference to the keys at the test plug

**Cause:** current measuring path interrupted  
**Result:** no measured value display

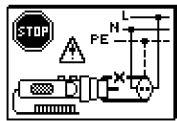

**Note**

See “LED Indications, Mains Connections and Potential Differences” on page 17.



**Attention!**

Reversal of N and PE in a system without RCCBs cannot be detected and is not indicated by the instrument. In a system including an RCCB, the RCCB is tripped during touch voltage measurement without RCCB tripping (automatic  $Z_{L-N}$  measurement), insofar as N and PE are reversed.

**10.6 Help Function**

The following information can be displayed for each switch position and basic function **after it has been selected with the rotary selector switch:**

- Wiring diagram
  - Measuring range
  - Nominal range of use as well as measuring and intrinsic uncertainties
  - Nominal value
- Press the **HELP** key in order to query online help.
  - If several pages of help are available for the respective measuring function, the **HELP** key must be pressed repeatedly.
  - Press the **ESC** key in order to exit online help.

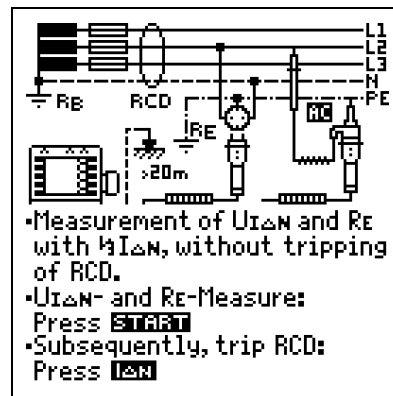

## 10.7 Setting Parameters or Limit Values using RCD Measurement as an Example

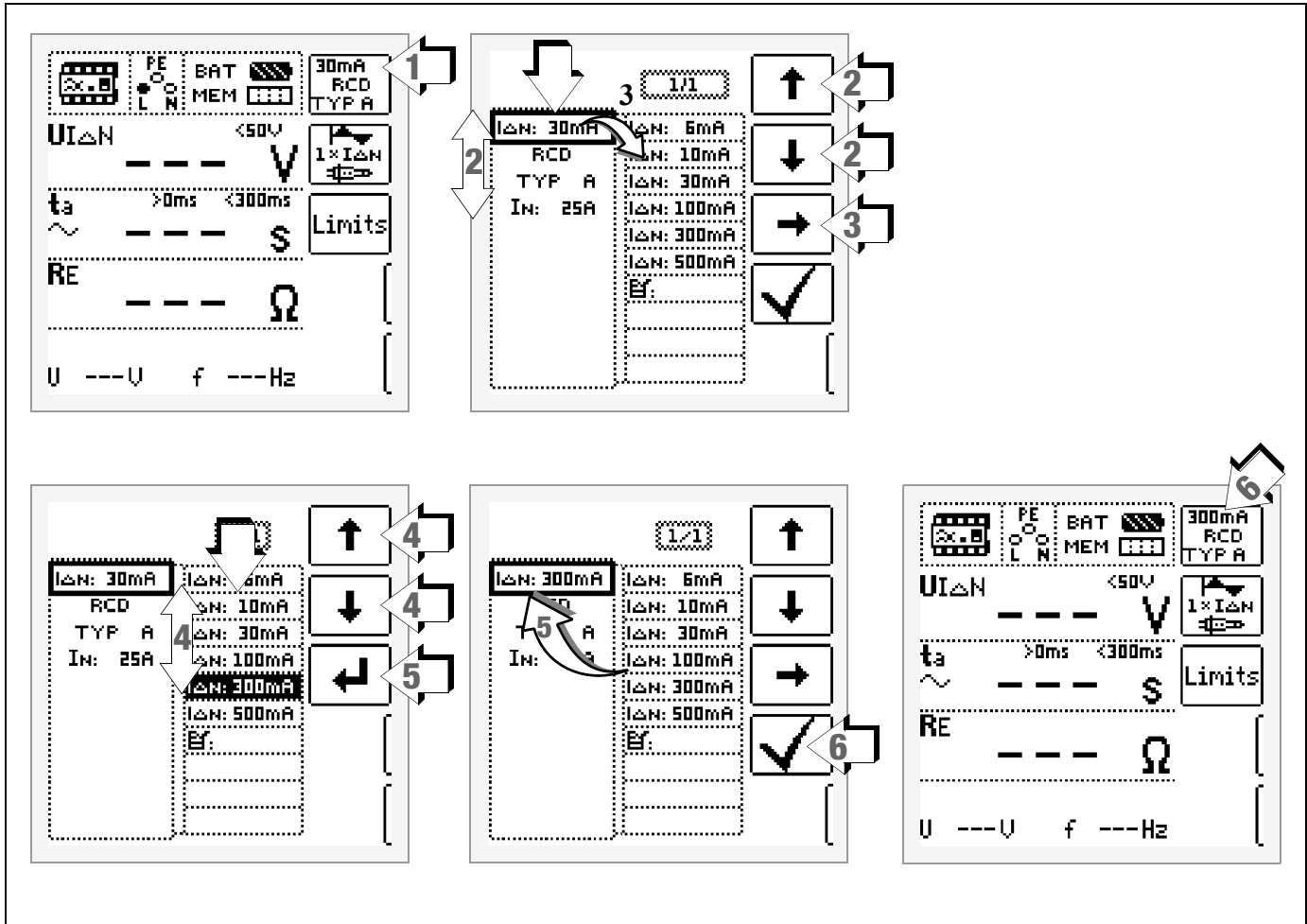

- 1 Access the submenu for setting the desired parameter.
- 2 Select a parameter using the  $\uparrow$  or  $\downarrow$  scroll key.
- 3 Switch to the setting menu for the selected parameter with the  $\rightarrow$  scroll key.
- 4 Select a setting value using the  $\uparrow$  or  $\downarrow$  scroll key.
- 5 Acknowledge the setting value with the  $\downarrow$  key. This value is transferred to the settings menu.
- 6 The setting value is not permanently accepted for the respective measurement until  $\checkmark$  is pressed, after which the display is returned to the main menu. You can return to the main menu by pressing **ESC** instead of  $\checkmark$ , without accepting the newly selected value.

### Parameter Lock (plausibility check)

Individually selected parameter settings are checked for plausibility before transfer to the measurement window.



If you select a parameter setting which doesn't make sense in combination with other parameter settings which have already been entered, it's not accepted. The previously selected parameter setting remains unchanged.

Remedy: select another parameter setting.

## 10.8 Freely Selectable Parameter Settings or Limit Values



### 10.8.1 Changing Existing Parameters

Individual parameters can be changed for certain measuring functions, i.e. adjusted within predetermined limits.

The **EDIT** menu  doesn't appear until after switching to the right-hand column and selecting the editable parameter .

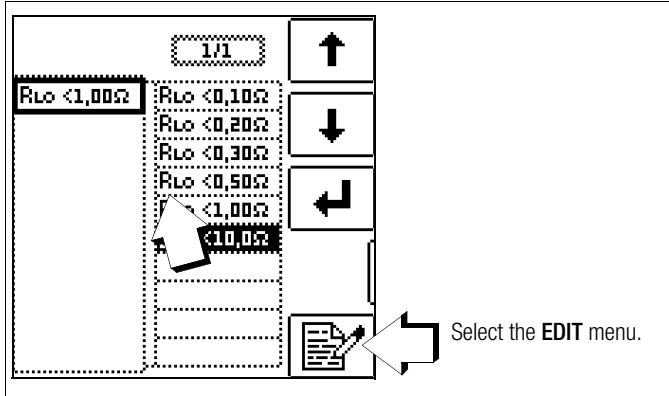
#### Example for RLO Measuring Function – Parameter: LIMIT RLO



- 1 Open the submenu for setting the desired parameter (no figure, see section 10.7).
- 2 Select the editable parameter – identified with the  icon – with the  $\uparrow$  or  $\downarrow$  scroll key.
- 3 Select the edit menu by pressing the  key.

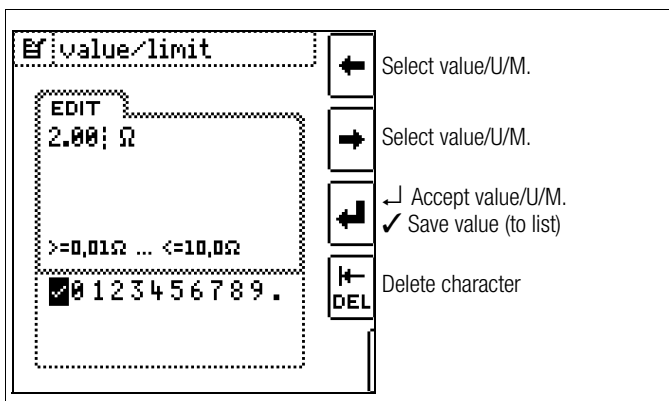

- 4 Select the respective characters with the left or right cursor key. The character is accepted by pressing the  $\downarrow$  key. The value is acknowledged by selecting  $\checkmark$  and then pressing the  $\downarrow$  key.

#### Note

Observe the predefined limits for the new setting value. Enter any places to the right of the decimal point as well.

### 10.8.2 Adding New Parameters

For certain measuring functions, additional values within predefined limits can be added in addition to the fixed values.

The **EDIT+** menu  doesn't appear until after switching to the right-hand column.

#### Example for I<sub>ΔN</sub> Measuring Function – Parameter: I<sub>ΔN</sub>

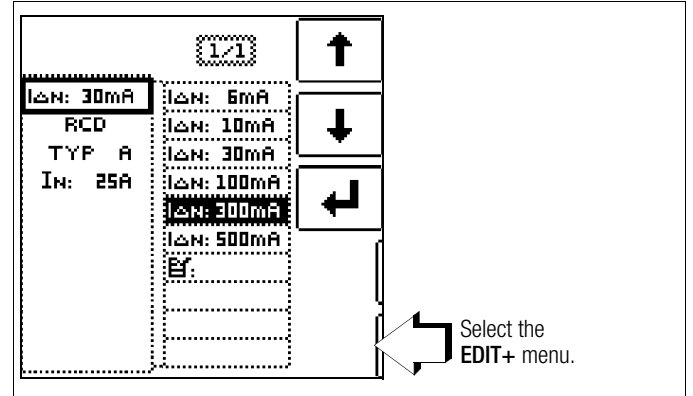

- 1 Open the submenu for setting the desired parameter (no figure, see section 10.7).

Select the edit menu by pressing the  key.

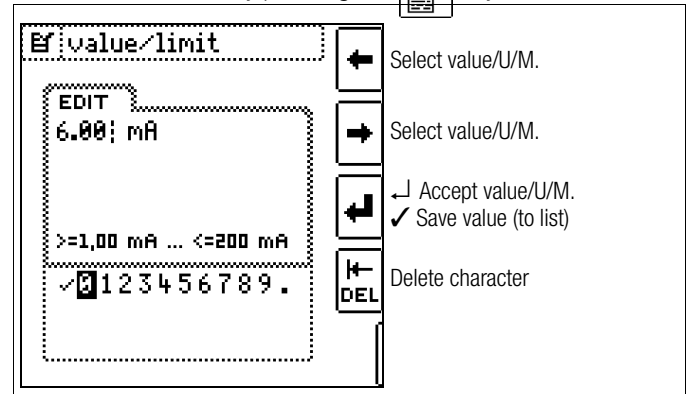

- 2 Select the respective characters with the **LEFT** or **RIGHT** cursor key. The character is accepted by pressing the  $\downarrow$  key. The value is acknowledged by selecting  $\checkmark$  and then pressing the  $\downarrow$  key. The new parameter is added to the list.

#### Note

Observe the predefined limits for the new setting value. Enter any places to the right of the decimal point as well.

## 10.9 2-Pole Measurement with Rapid or Semiautomatic Polarity Reversal

Rapid, semiautomatic polarity reversal is possible for the following measurements:

- Voltage  $U$
- Loop impedance  $Z_{L-PE}$
- Internal line resistance  $Z_{L-N}$
- Insulation resistance  $R_{INS}$

### Rapid Polarity Reversal at the Test Plug

The polarity parameter is set to **AUTO**.

Fast and convenient switching amongst all polarity variants, or switching to the parameter settings submenu, is possible by pressing the  $I_{\Delta N}$  key at the instrument or the test plug.

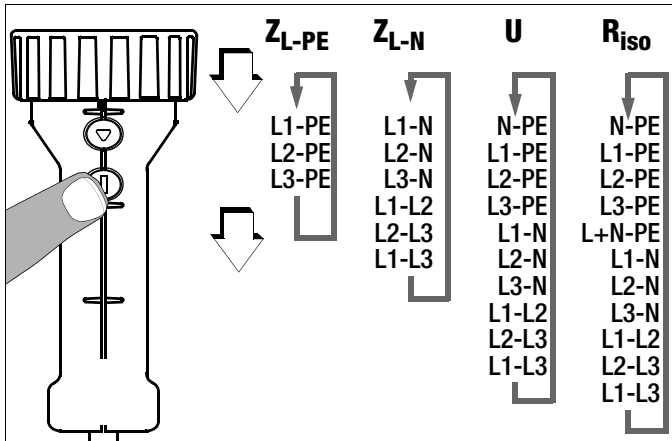
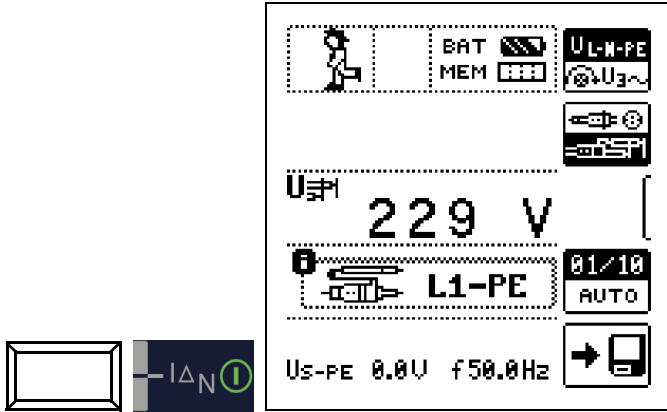

### Semiautomatic Polarity Reversal in Memory Mode

The polarity parameter is set to **AUTO**.

If testing is to be conducted with all polarity variants, automatic polarity changing takes place after each measurement after **saving**.

Polarity variants can be skipped by pressing the  $I_{\Delta N}$  key at the instrument or the test plug.

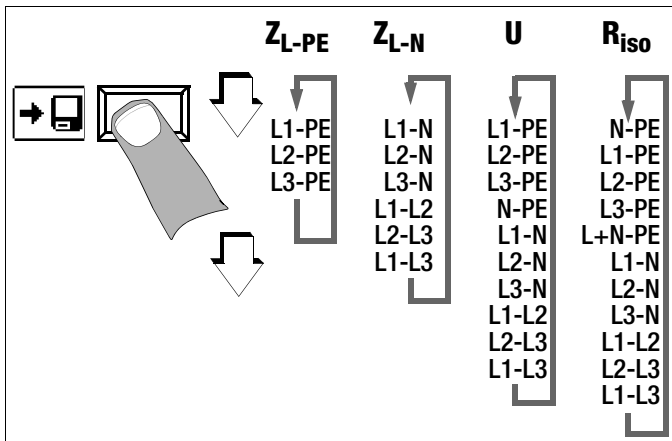



# 11 Measuring Voltage and Frequency

## Select the Measuring Function



### Switch Back and Forth Between Single and 3-Phase Measurement



Press the softkey shown at the left in order to switch back and forth between single and 3-phase measurement. The selected phase measurement is displayed inversely (white on black).

## 11.1 Single-Phase Measurement

### Connection

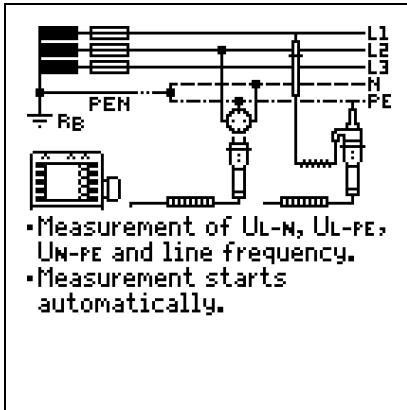

A probe must be used in order to measure probe voltage  $U_{S-PE}$ .

### 11.1.1 Voltage Between L and N ( $U_{L-N}$ ), L and PE ( $U_{L-PE}$ ) and N and PE ( $U_{N-PE}$ ) with Country-Specific Plug Insert, e.g. SCHUKO



Press the softkey shown at the left in order to switch back and forth between the country-specific plug insert, e.g. SCHUKO, and the 2-pole adapter. The selected connection type is displayed inversely (white on black).

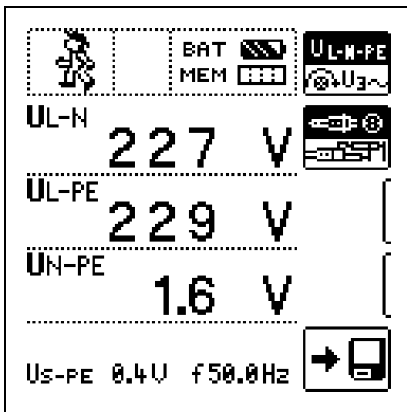

### Note

If you view the country-specific plug insert, e.g. SCHUKO, from the front, you'll see two embossed letters, namely L and N. Automatic polarity reversal does not take place during voltage measurement. You can thus specify the terminal to which the phase is connected in the socket. If (mains) voltage is displayed for  $U_{L-PE}$ , then the phase is located where L appears on the connector. If (mains) voltage is displayed for  $U_{N-PE}$ , then the phase is located where N appears on the connector.

## 11.1.2 Voltage Between L – PE, N – PE and L – L with 2-Pole Adapter Connection



Press the softkey shown at the left in order to switch back and forth between the country-specific plug insert, e.g. SCHUKO, and the 2-pole adapter. The selected connection type is displayed inversely (white on black).

See section 10.9 concerning 2-pole measurement with rapid or semiautomatic polarity reversal.

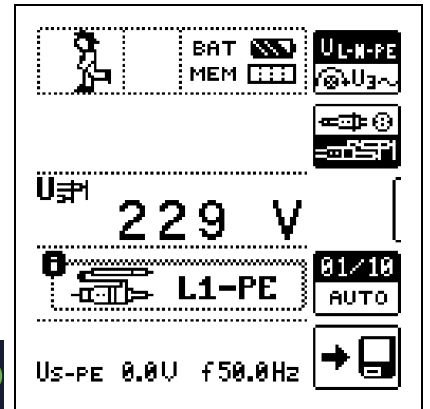
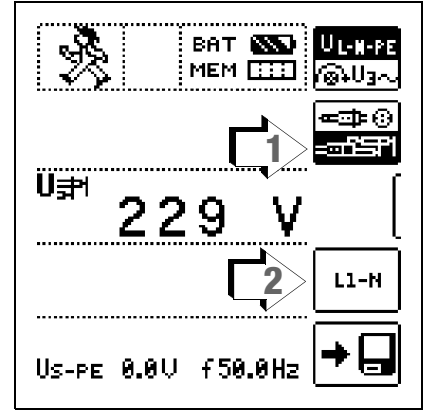

## 11.2 3-Phase Measurement (line-to-line voltage) and Phase Sequence

### Connection

The measuring adapter (2-pole) is required in order to connect the instrument, and is expanded to a 3-pole measuring adapter with the included measurement cable.

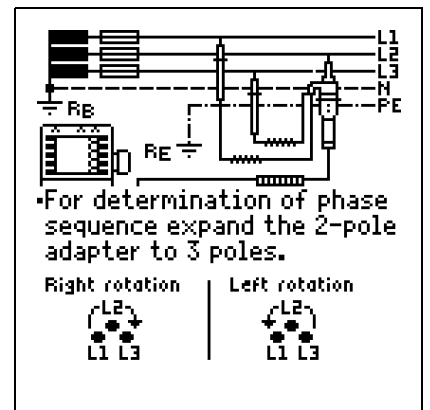

⇨ Press softkey U3~.

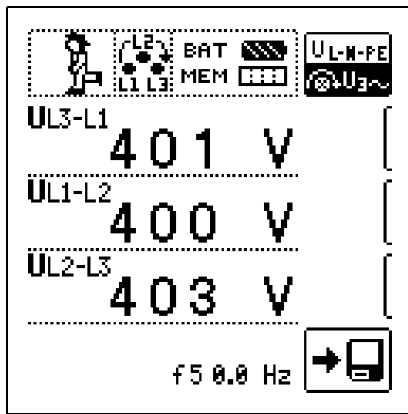

A clockwise phase sequence is required at all 3-phase electrical outlets.

- Measurement instrument connection is usually problematic with CEE outlets due to contact problems. Measurements can be executed quickly and reliably without contact problems with the help of the Z500A variable plug adapter set available from GMC.
- Connection for 3-wire measurement: L1-L2-L3 at plug in clockwise direction as of PE socket

Direction of rotation is indicated by means of the following displays:



#### Note

See section 6.4 regarding all indications for the mains connection test.

### Voltage Polarity

If the installation of single-pole switches to the neutral conductor is prohibited by the standards, voltage polarity must be tested in order to assure that all existing single-pole switches are installed to the phase conductors.

## 12 Testing RCDs

The testing of residual current devices (RCDs) includes:

- Visual inspection
- Testing
- Measurement

Use the test instrument for testing and measurement.



### Attention!

When testing systems with RCCBs, they may switch off. This may occur even though it's not normally provided for by the test. Leakage currents may be present which, in combination with the test current of the test instrument, exceed the shutdown threshold value of the RCCB. PCs which are operated in proximity to such RCCB systems may switch off as a consequence. This may result in inadvertent loss of data. Before conducting the test, precautions should therefore be taken to ensure that all data and programs are suitably backed up and the computer should be switched off, if necessary. The manufacturer of the test instrument assumes no liability for any direct or indirect damage to equipment, computers, peripheral equipment or data bases when performing the tests.

### Measuring Method

The following must be substantiated by generating a fault current downstream from the RCD:

- That the RCD is tripped no later than upon reaching its nominal fault current value
- That the continuously permissible touch voltage value  $U_L$  agreed upon for the respective system is not exceeded

This is achieved by means of:

- Touch voltage measurement  
10 measurements with full-waves and extrapolation of  $I_{\Delta N}$

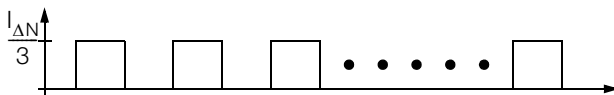

- Substantiation of tripping within 400 ms or 200 ms with  $I_{\Delta N}$

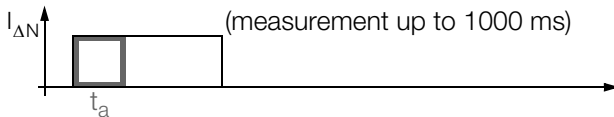

- Substantiation of tripping current with rising residual current  
This value must be between 50% and 100% of  $I_{\Delta N}$  (usually about 70%).

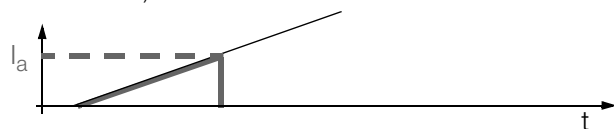

- No premature tripping with the test instrument, because testing is begun with 30% residual current (if no bias current occurs within the system).

RCD/FI Table	Waveform Differential Current	Correct RCD/RCCB Function			
		Type AC	Type A/F	Type B*/ B+*	Type EV/ MI*
Alternating current	Suddenly occurring 	✓	✓	✓	✓
	Slowly rising 				
Pulsating direct current	Suddenly occurring 		✓	✓	✓
	Slowly rising 				
Direct current				✓	✓
Direct current up to 6 mA					✓

\* only PROFITEST MTECH+, PROFITEST MXTRA

### Test Standard

The following must be substantiated per IEC 60364-6:

- Touch voltage occurring at nominal residual current may not exceed the maximum permissible value for the system.
- Tripping of the RCCB must occur within 400 ms (1000 ms for selective RCDs) at nominal residual current.

### Important Notes

- The test instrument permits simple measurements at all types of RCDs. Select RCD, SRCD, PRCD etc.
- Measurement must be executed at one point only per RCD (RCCB) within the connected electrical circuits. Low-resistance continuity must be substantiated for the protective conductor at all other connections within the electrical circuit ( $R_{LO}$  or  $U_B$ ).
- The measuring instruments often display 0.1 V touch voltage in TN systems due to low protective conductor resistance.
- Be aware of any bias currents within the system. These may cause tripping of the RCDs during measurement of touch voltage  $U_B$ , or may result in erroneous displays for measurements with rising current:  
Display =  $I_F$  -  $I_{\text{bias current}}$
- Selective RCDs identified with an **S** can be used as the sole means of protection for automatic shutdown if they adhere to the same shutdown conditions as non-selective RCDs (i.e.  $t_a < 400$  ms). This can be verified by measuring breaking time.
- Type B RCDs may not be connected in series with type A or F RCDs.



### Note

#### Bias Magnetization

Only AC measurements can be performed with the 2-pole adapter. Suppression of RCD tripping by means of bias magnetization with direct current is only possible via a country-specific plug insert, e.g. SCHUKO, or the 3-pole adapter.

## Measurement With or Without Probe

Measurements can be performed with or without a probe.

Measurements with probe require that the probe and reference earth are of like potential. This means that the probe must be positioned outside of the potential gradient area of the earth electrode ( $R_E$ ) in the RCD safety circuit.

The distance between the earth electrode and the probe should be at least 20 m.

The probe is connected with a 4 mm contact-protected plug.

In most cases this measurement is performed without probe.



### Attention!

The probe is part of the measuring circuit and may carry a current of up to 3.5 mA in accordance with IEC 61557 / EN 61557.

Testing for the absence of voltage at the probe can be performed with the  $U_{PROBE}$  function (see also section 11.1 on page 41).

## 12.1 Measuring Touch Voltage (with reference to nominal residual current) with $\frac{1}{3}$ Nominal Residual Current and Tripping Test with Nominal Residual Current

### Select Measuring Function

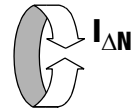

### Connection

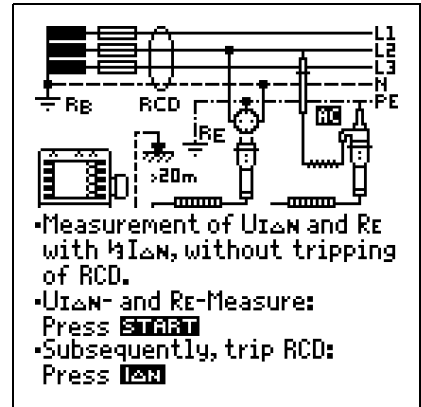

### Set Parameters for $I_{\Delta N}$

**30mA**  
**RCD**  
**TYP A**

Nom. res. current: 10 ... 500 mA  $I_{\Delta N}$

Type 1: RCD, SRCD, PRCD ...

Type 2\*: AC, A, F, B, B+, EV, MI

Nominal current: 6 ... 125 A

\* Types B, B+, EV, MI = AC/DC sensitive

$I_{\Delta N}$ : 30mA  
 $I_{\Delta N}$ : 5mA  
 $I_{\Delta N}$ : 10mA  
 $I_{\Delta N}$ : 30mA  
 $I_{\Delta N}$ : 100mA  
 $I_{\Delta N}$ : 300mA  
 $I_{\Delta N}$ : 500mA

$I_{\Delta N}$ : 25A  
 $I_{\Delta N}$ : 5A  
 $I_{\Delta N}$ : 10A  
 $I_{\Delta N}$ : 30A  
 $I_{\Delta N}$ : 100A  
 $I_{\Delta N}$ : 300A  
 $I_{\Delta N}$ : 500A

**1 x  $I_{\Delta N}$**   
**TH/TT**

Waveform:

Phase displacement: 0°/180°

Negative/positive half-wave

Negative/positive direct current

X times tripping current:

1, 2, 5 ( $I_{\Delta N}$  max. 300 mA)

Connection:

Without/with probe

System type:

TN/TT, IT

0°  
 180°  
 NEG.  
 POS.  
 NEG.  
 POS.

**Limits**

Touch voltage:

< 25 V, < 50 V, < 65 V  $E_f$

Time to trip:

UL: <50V  
 to: <300ms  
 to: >0ms

UL: <25V  
 UL: <50V  
 UL: <65V

## 1) Measuring Touch Current Without Tripping the RCD

### Measuring Method

The instrument uses a measuring current of only 1/3 nominal residual current for the determination of touch voltage  $U_{I\Delta N}$  which occurs at nominal residual current. This prevents tripping of the RCCB.

This measuring method is especially advantageous, because touch voltage can be measured quickly and easily at any electrical outlet without tripping the RCCB.

The usual, complex measuring method involving testing for the proper functioning of the RCD at a given point, and subsequent substantiation that all other systems components requiring protection are reliably connected at low resistance values to the selected measuring point via the PE conductor, is made unnecessary.

### N-PE Reversal Test

Additional testing is conducted in order to determine whether or not N and PE are reversed. The pop-up window shown at the right appears in the event of reversal.

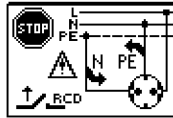

### Attention!

In order to prevent the loss of data in data processing systems, perform a data backup before starting the measurement and switch off all consumers.

### Start Measurement

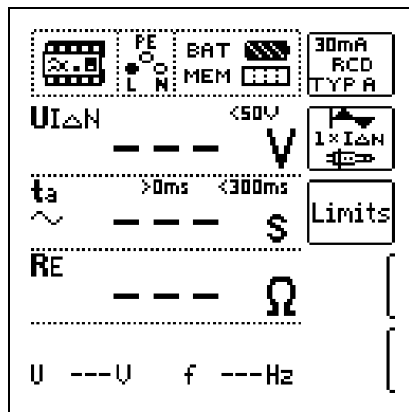

Amongst other values, touch voltage  $U_{I\Delta N}$  and calculated earthing resistance  $R_E$  appear at the display panel.

### Note

The measured earthing resistance value  $R_E$  is acquired with very little current. More accurate results can be obtained with the selector switch in the  $R_E$  position. The DC + function can be selected here for systems with RCCBs.

Unintentional Tripping of the RCD due to Bias Current in the System  
Any bias current which might occur can be ascertained as described in section 18.1 on page 80 with the help of a current clamp transformer. The RCCB may be tripped during the testing of touch voltage if extremely large bias currents are present within the system, or if a test current was selected which is too great for the RCCB.

After touch voltage has been measured, testing can be performed to determine whether or not the RCCB is tripped within the selected time limit values at nominal residual current.

Unintentional Tripping of the RCD due to Leakage Current in the Measuring Circuit

Measurement of touch voltage with 30% nominal residual current does not normally trip an RCCB. However, the trip limit may be exceeded as a result of leakage current in the measuring circuit, e.g. due to interconnected consumers with EMC circuit, e.g. frequency converters or PCs.

## 2) Tripping Test after the Measurement of Touch Voltage

⇨ Press the  $I_{\Delta N}$  key.

The tripping test need only be performed at one measuring point for each RCCB.

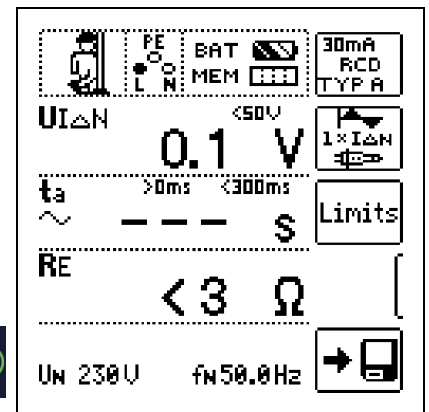

If the RCCB is not tripped at nominal residual current, the MAINS/NETZ LED blinks red (line voltage disconnected) and, amongst other values, time to trip  $t_a$  and earthing resistance  $R_E$  appear at the display panel.

If the RCCB is not tripped at nominal residual current, the RCD/FI LED lights up red.

### Touch Voltage Too High

If touch voltage  $U_{I\Delta N}$ , which has been measured with 1/3 nominal residual current  $I_{\Delta N}$  and extrapolated to  $I_{\Delta N}$ , is  $> 50 \text{ V}$  ( $> 25 \text{ V}$ ), the  $U_L/R_L$  LED lights up red.

If the limit value for touch voltage is exceeded during the measurement process,  $U_{I\Delta N} > 50 \text{ V}$  ( $> 25 \text{ V}$ ), safety shutdown occurs for Germany (65 V applies for Austria – standard: ÖVE/ÖNORM E 8001-1 section 5.3).

### Note

**Safety shutdown:** At up to 70 V, a safety shutdown is tripped within 3 s in accordance with IEC 61010.

Touch voltages of up to 70 V are displayed. If the value is greater than 70 V,  $U_{I\Delta N} > 70 \text{ V}$  is displayed.

### Limit Values for Permissible, Continuous Touch Voltage

The limit for permissible, continuous touch voltage is equal to  $U_L = 50 \text{ V}$  for alternating voltages (international agreement). Lower values have been established for special applications (e.g. medical applications:  $U_L = 25 \text{ V}$ ).

### Attention!

If touch voltage is too high, or if the RCCB is not tripped, the system must be repaired (e.g. earthing resistance is too high, defective RCCB etc.)!

### 3-Phase Connections

For proper RCD testing at three-phase connections, the tripping test must be conducted for one of the three phase conductors (L1, L2 or L3).

### Inductive Power Consumers

Voltage peaks may occur within the measuring circuit if inductive consumers are shut down during an RCCB trip test. If this is the case, the test instrument might not display any measured value (---). If this message appears, switch all consumers off before performing the trip test. In extreme cases, one of the fuses in the test instrument may blow, and/or the test instrument may be damaged.

## 12.2 Special Tests for Systems and RCCDs

### 12.2.1 Testing Systems and RCCBs with Rising Residual Current (AC) for Type AC, A/F, B/B+ and EV/MI RCCDs (PROFITEST MTECH+, PROFITEST MXTRA only)

#### Measuring Method

The instrument generates a continuously rising residual current of  $(0.3 \dots 1.3) \times I_{\Delta N}$  within the system for the testing of RCCDs. The instrument stores the touch voltage and tripping current values which were measured at the moment tripping of the RCCB occurred, and displays them.

One of the touch voltage limit values,  $U_L = 25 \text{ V}$  or  $U_L = 50/65 \text{ V}$ , can be selected for measurement with rising residual current.

#### Select Measuring Function

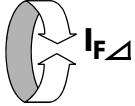

#### Connection

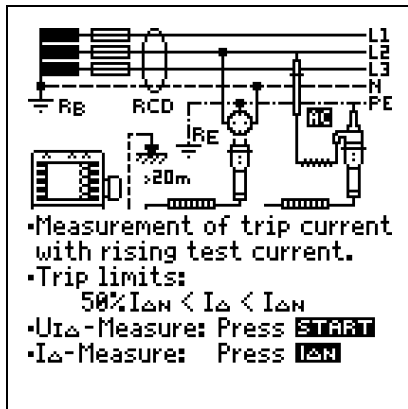

#### Set Parameters for $I_{\Delta}$

**30mA RCD TYP A**  
 Nom. res. current: 10 ... 500 mA  
 Type 1: RCD, SRCD, PRCD ...  
 Type 2\*: AC, A, F, B, B+, EV, MI  
 Nominal current: 6 ... 125 A  
 \* Types B, B+, EV, MI = AC/DC sensitive

**TN/TT**  
 Waveform:  
 Sinusoidal  
 Negative/positive half-wave  
 Negative/positive direct current  
 Connection:  
 Without/with probe  
 System type:  
 TN/TT, IT

**Limits**  
 Touch voltage:  
 UL: <50V  
 UL: <25V  
 UL: <50V  
 UL: <65V  
 Tripping limit values:  
 IΔ: >15.0mA  
 IΔ: <30.0mA

#### Start Measurement



**30mA RCD TYP A**  
 UIΔN <50V V  
 IΔ >15.0mA <30.0mA mA  
 RE Ω  
 U ---V f ---Hz

#### Measuring Procedure

After the measuring sequence has been started, the test current generated by the instrument is continuously increased starting at 0.3 times nominal residual current, until the RCCB is tripped. This can be observed by viewing gradual filling of the triangle at  $I_{\Delta}$ .

If touch voltage reaches the selected limit value ( $U_L = 65 \text{ V}$ ,  $50 \text{ V}$  or  $25 \text{ V}$ ) before the RCCB is tripped, safety shutdown occurs. The  $U_L/R_L$  LED lights up red.



#### Note

**Safety shutdown:** At up to 70 V, safety shutdown is triggered within 3 s in accordance with IEC 61010.

If the RCCB is not tripped before rising current reaches nominal residual current  $I_{\Delta N}$ , the RCD/FI LED lights up red.



#### Attention!

If bias current is present within the system during measurement, it's superimposed onto the residual current which is generated by the instrument and influences measured values for touch voltage and tripping current. See also section 12.1.

#### Evaluation

According to IEC 60364-6, rising residual current must, however, be used for measurements in the evaluation of RCCDs, and touch voltage at nominal residual current  $I_{\Delta N}$  must be calculated from the measured values.

The faster, more simple measuring method should thus be taken advantage of (see section 12.1).

### 12.2.2 Testing Systems and RCCBs with Rising Residual Current (AC) for Type B/B+ and EV/MI RCDs (PROFITEST MTECH+PROFITEST MXTRA)

In accordance with IEC 61557 / EN 61557, it must be substantiated that, with smooth direct current, residual operating current is no more than twice the value of rated residual current  $I_{\Delta N}$ . A continuously rising direct current, beginning with 0.2 times rated residual current  $I_{\Delta N}$ , must be applied to this end. If current rise is linear, rising current may not exceed twice the value of  $I_{\Delta N}$  within a period of 5 seconds.

Testing with smoothed direct current must be possible in both test current directions.

### 12.2.3 Testing RCCBS with $5 \times I_{\Delta N}$

Measurement of time to trip is performed here with 5 times nominal residual current.



#### Note

Measurements performed with 5 times nominal fault current are required for testing type **S** and G RCCBs in the manufacturing process. They're used for personal safety as well.

Measurement can be started with the positive half-wave at "0°" or with the negative half-wave at "180°".

Both measurements must nevertheless be performed. The longer of the two tripping times is decisive regarding the condition of the tested RCCB. Both values must be less than 40 ms.

### Select Measuring Function

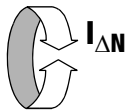

### Start Measurement

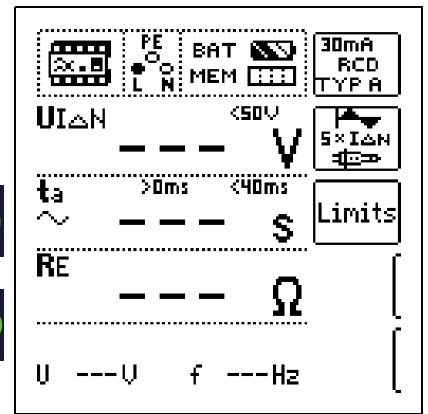

### Set Parameter – Start with Positive or Negative Half-Wave

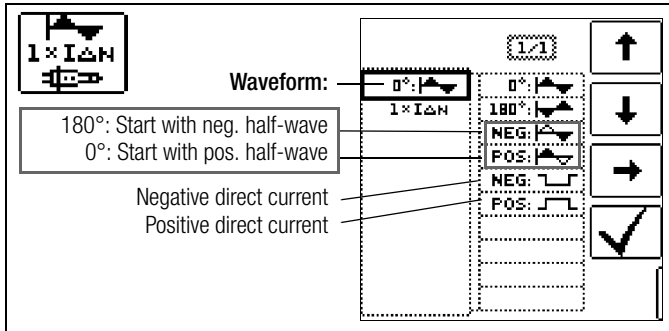

### Set Parameter – 5 Times Nominal Current

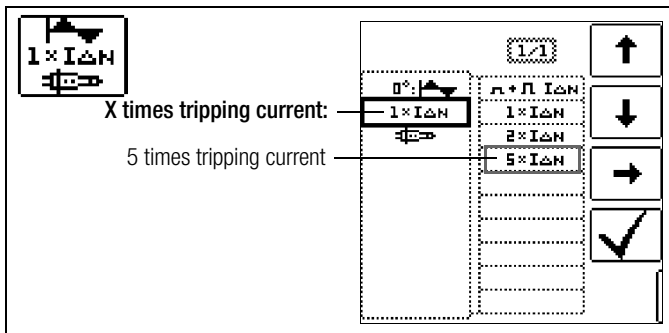

#### Note

The following restrictions apply to the selection of tripping current multiples relative to nominal current:  
500 mA:  $1 \times I_{\Delta N}$ ,  $2 \times I_{\Delta N}$

## 12.2.4 Testing of RCCBs which are Suitable for Pulsating DC Residual Current

In this case, RCCBs can be tested with either positive or negative half-waves. The standard calls for tripping at 1.4 times nominal current.

### Select Measuring Function

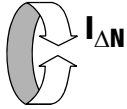

### Set Parameter – Positive or Negative Half-Wave

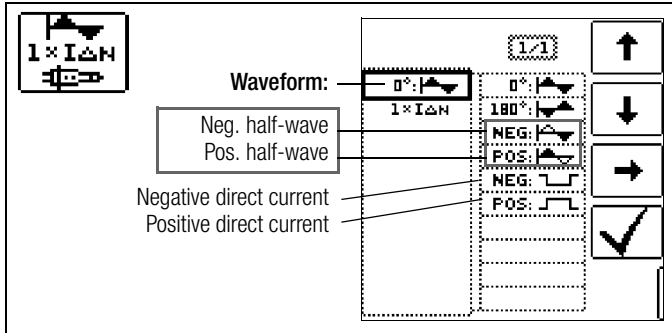

### Set Parameter – Test With and Without “No-Trip Test”

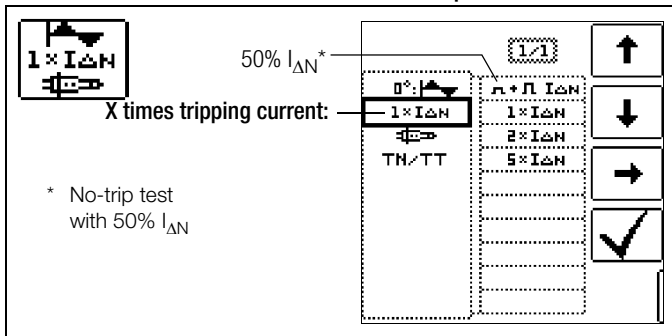

### No-Trip Test

If, during the no-trip test which lasts for 1 second, the RCD trips too early at 50%  $I_{\Delta N}$ , i.e. before the actual tripping test starts, the pop-up window shown at the right appears.

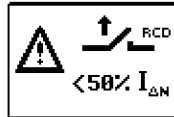

### Note

The following restrictions apply to the selection of tripping current multiples relative to nominal current:  
500 mA: double and five-fold nominal current is not possible in this case.



### Note

According to DIN EN 50178 (VDE 160), only type B RCCBs (AC-DC sensitive) can be used for equipment with > 4 kVA, which is capable of generating smooth DC residual current (e.g. frequency converters). Tests with pulsating DC fault current only are not suitable for these RCCBs. Testing must also be conducted with smooth DC residual current in this case.



### Note

Measurement is performed with positive and negative half-waves for testing RCCBs during manufacturing. If a circuit is charged with pulsating direct current, the function of the RCCB can be executed with this test in order to assure that the RCCB is not saturated by the pulsating direct current so that it no longer trips.

## 12.3 Testing of Special RCDs

### 12.3.1 Systems with Type RCD-S Selective RCCBs

Selective RCCBs are used in systems which include two series connected RCCBs which are not tripped simultaneously in the event of a fault. These selective RCCBs demonstrate delayed response characteristics and are identified with the symbol.

### Measuring Method

The same measuring method is used as for standard RCCBs (see sections 12.1 on page 44 and 12.2.1 on page 46).

If selective RCDs are used, earthing resistance may not exceed half of the value for standard RCCBs.

For this reason, the instrument displays twice the measured value for touch voltage.

### Select Measuring Function

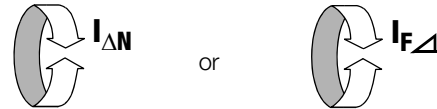

### Set Parameter – Selective

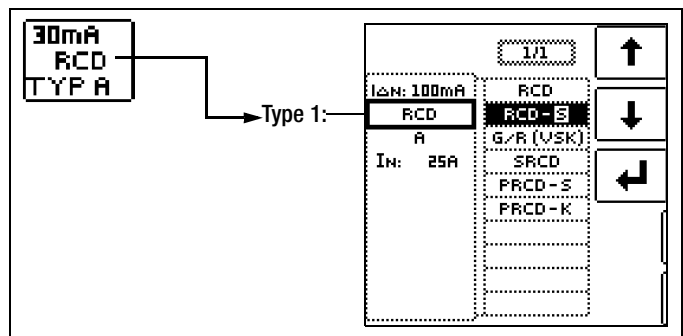

### Start Measurement

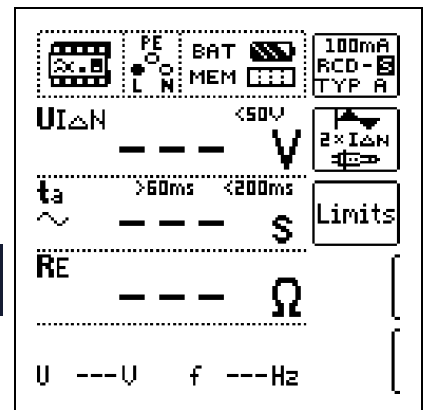

### Tripping Test

- Press the  $I_{\Delta N}$  key. The RCCB is tripped. Blinking bars appear at the display panel, after which time to trip  $t_A$  and earthing resistance  $R_E$  are displayed.

The tripping test need only be performed at one measuring point for each RCCB.

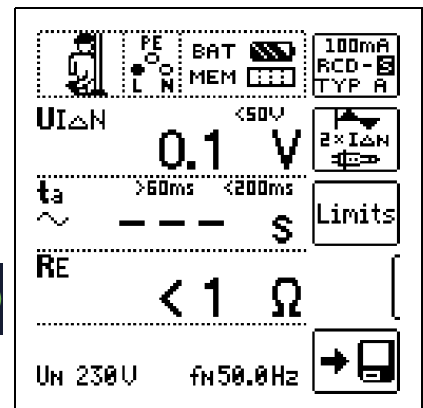





### Note

Selective RCDs demonstrate delayed response characteristics. Tripping performance is briefly influenced (up to 30 s) due to pre-loading during measurement of touch voltage. In order to eliminate pre-charging caused by the measurement of touch voltage, a waiting period must be observed prior to the tripping test. After the measuring sequence has been started (tripping test), blinking bars are displayed for approximately 30 seconds. Tripping times of up to 1000 ms are permissible. The tripping test is executed immediately after once again pressing the  $I_{\Delta N}$  key.

### 12.3.2 PRCDs with Non-Linear Type PRCD-K Elements

The PRCD-K is a portable RCD with electronic residual current evaluation laid out as an inline device which switches all poles (L, N and PE). Undervoltage tripping and protective conductor monitoring are additionally integrated into the PRCD-K.

The PRCD-K is equipped with undervoltage tripping, for which reason it has to be operated with line voltage, and measurements may only be performed in the on state (PRCD-K switches all poles).

#### Terminology (from DIN VDE 0661)

Portable protective devices are circuit breakers which can be connected between power consuming devices and permanently installed electrical outlets by means of standardized plug-and-socket devices.

A reusable, portable protective device is a protective device which is designed such that it can be connected to movable cables.

Please be aware that a non-linear element is usually integrated into PRCDs, which leads to immediate exceeding of the greatest permissible touch voltage during  $U_{I\Delta}$  measurements ( $U_{I\Delta}$  greater than 50 V).

PRCDs which do not include a non-linear element in the protective conductor must be tested in accordance with section 12.3.3 on page 50.

#### Objective (from DIN VDE 0661)

Portable residual current devices (PRCDs) serve to protect persons and property. They allow for the attainment of increased levels of protection as provided by protective measures utilized in electrical systems for the prevention of electrical shock as defined in DIN VDE 0100-410. They are to be designed such that they can be installed by means of a plug attached directly to the protective device, or by means of a plug with a short cable.

#### Measuring Method

The following can be measured, depending upon the measuring method:

- Time to trip  $t_A$ : tripping test with nominal residual current  $I_{\Delta N}$  (the PRCD-K must be tripped at 50% nominal current)
- Tripping current  $I_{\Delta}$  for testing with rising residual current  $I_{F\Delta}$

#### Select Measuring Function

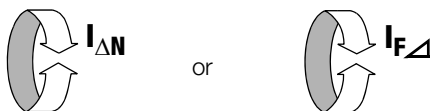

#### Connection

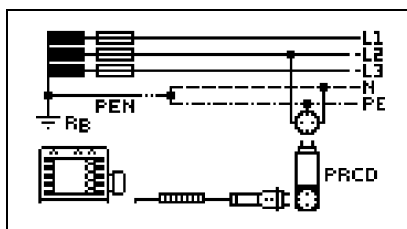

### Set Parameter – PRCD with Non-Linear Elements

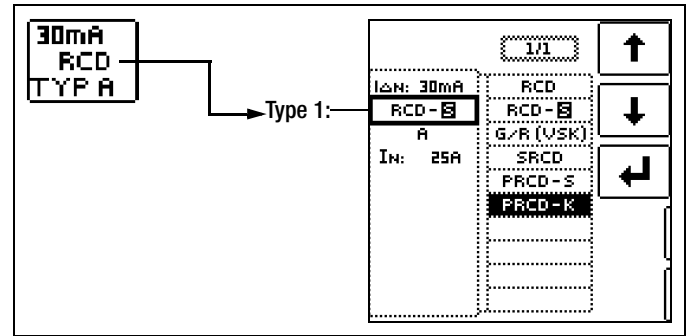

### Start Measurement

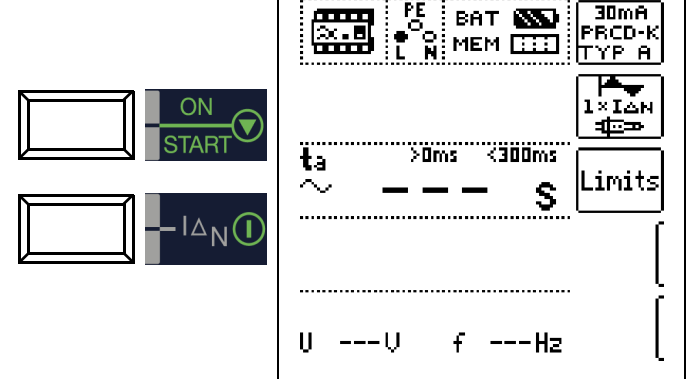

### 12.3.3 SRCD, PRCD-S (SCHUKOMAT, SIDOS or comparable)

RCCBs from the SCHUKOMAT SIDOS series, as well as others which are of identical electrical design, must be tested after selecting the corresponding parameter.

Monitoring of the PE conductor is performed for RCDs of this type. The PE conductor is monitored by the summation current transformer. If residual current flows from L to PE, tripping current is cut in half, i.e. the RCCB must be tripped at 50% nominal residual current  $I_{\Delta N}$ .

Whether or not PRCDs and selective RCDs are of like design can be tested by means of touch voltage  $U_{I\Delta N}$  measurement. If a touch voltage  $U_{I\Delta N}$  of greater than 70 V is measured at the PRCD of an otherwise error-free system, the PRCD more than likely contains a non-linear element.

#### PRCD-S

The PRCD-S (portable residual current device – safety) is a special, portable, protective device with protective conductor detection or protective conductor monitoring. The device serves to protect persons from electrical accidents in the low-voltage range (130 to 1000 V). The PRCD-S must be suitable for commercial use, and is installed like an extension cable between an electrical consumer – as a rule an electrical tool – and the electrical outlet.

#### Select Measuring Function

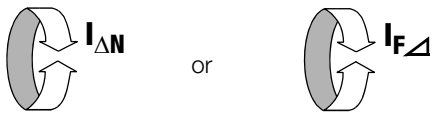

#### Set Parameter – SRCD / PRCD

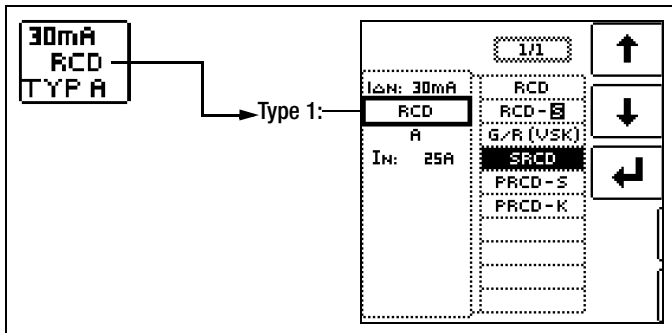

#### Start Measurement

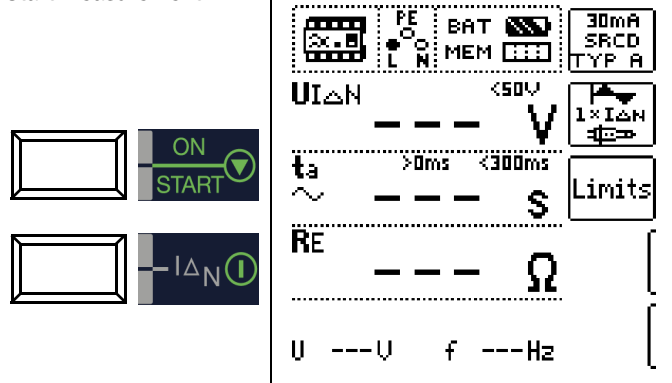

### 12.3.4 Type G or R RCCB

In addition to standard RCCBs and selective RCDs, the special characteristics of the type G RCCB can also be tested with the test instrument.

The type G RCCB is an Austrian specialty which complies with device standard ÖVE/ÖNORM E 8601. Erroneous tripping is minimized thanks to its greater current carrying capacity and short-term delay.

#### Select Measuring Function

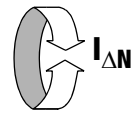

#### Set Parameter – Type G/R (VSK)

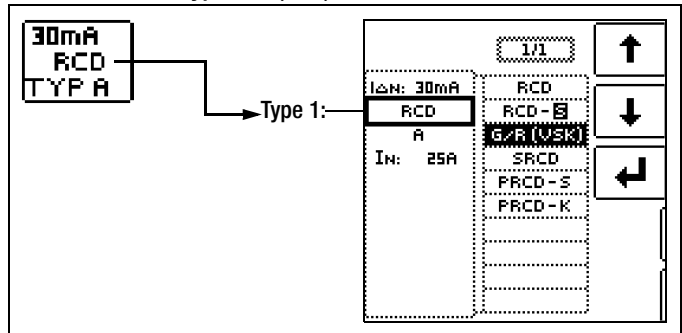

Touch voltage and time to trip can be measured in the G/R-RCD switch position.

#### Note

It must be observed that time to trip for type G RCCBs may be as long as 1000 ms when measurement is made at nominal residual current. Set the limit value correspondingly.

- Then select  $5 \times I_{\Delta N}$  in the menu (this is selected automatically for the G/R setting) and repeat the tripping test beginning with the positive half-wave at  $0^\circ$  and the negative half-wave at  $180^\circ$ . The longer of the two tripping times is decisive regarding the condition of the tested RCCB.

#### Set Parameter – Start with Positive or Negative Half-Wave

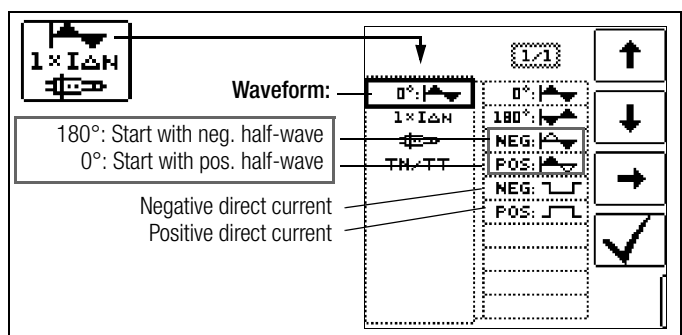

### Set Parameter – 5 Times Nominal Current

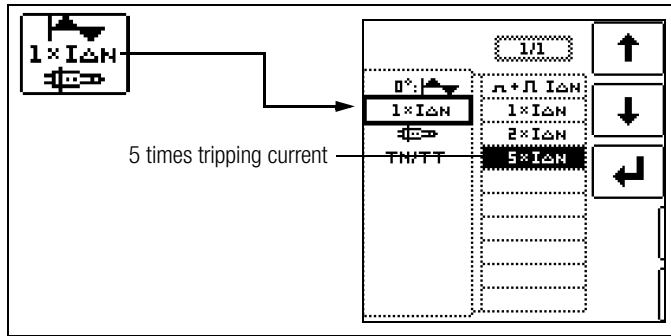

**Note**

The following restrictions apply to the selection of tripping current multiples relative to nominal current:  
500 mA: 1 ×, 2 × I<sub>ΔN</sub>

### Start Measurement



In both cases tripping time must be between 10 ms (minimum delay time for type G RCCBs!) and 40 ms.

Type G RCCBs with other nominal residual current values must be tested with the corresponding parameter setting under menu item I<sub>ΔN</sub>. In this case as well, the limit value must be appropriately adjusted.

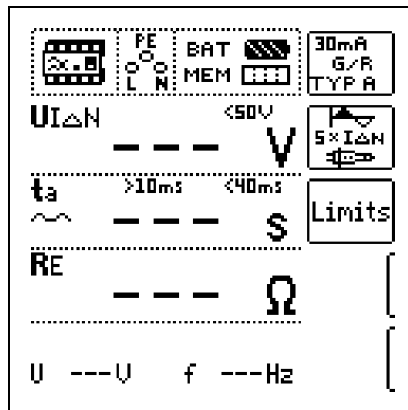

**Note**

The RCD **S** parameter setting for selective RCCBs is not suitable for type G RCCBs.

## 12.4 Testing Residual Current Circuit Breakers in TN-S Systems

### Connection

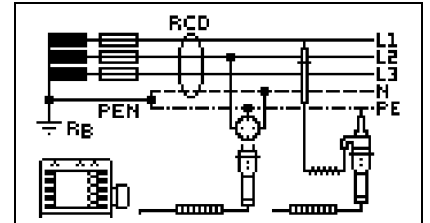

RCCBs can only be used in TN-S systems. An RCCB would not work in a TN-C system because PE is directly connected to the neutral conductor in the outlet (it does not bypass the RCCB). This means that residual current would be returned via the RCCB and would not generate any differential current, which is required in order to trip the RCCB.

As a rule, the display for touch voltage is also 0.1 V, because the nominal residual current of 30 mA together with minimal loop resistance result in a very small voltage value:

$$U_{I\Delta N} = R_E \times I_{\Delta N} = 1 \Omega \times 30 \text{ mA} = 30 \text{ mV} = 0.03 \text{ V}$$

## 12.5 Testing of RCD Protection in IT Systems with High Cable Capacitance (e.g. In Norway)

The desired system type (TN/TT or IT) can be selected for RCD test type  $U_{I\Delta N}$  ( $I_{\Delta N}$ ,  $t_a$ ), and for earthing measurement ( $R_E$ ).

A probe is absolutely essential for measurement in IT systems, because touch voltage  $U_{I\Delta N}$  which occurs in these systems can not otherwise be measured.

After selecting the IT system setting, connection with probe is selected automatically.

### Set Parameter – Select System Type

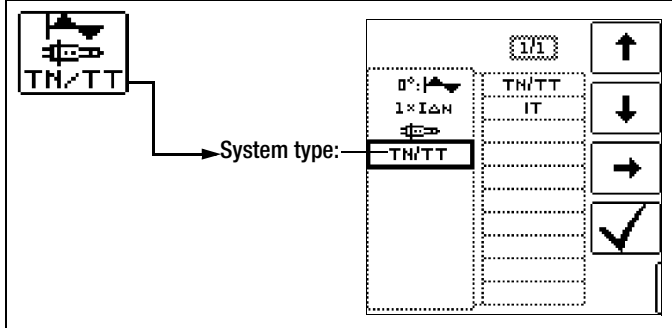

### Start Measurement

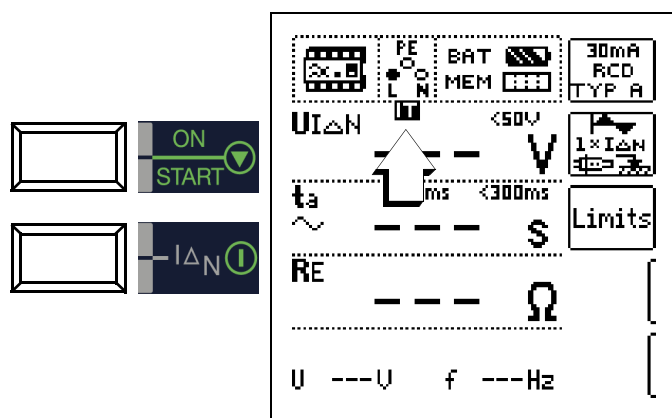

## 12.6 Testing of 6 mA Residual Current Devices RDC-DD/RCMB (RDC-DD: PROFITEST MXTRA and PROFITEST MTECH+ only)

DIN VDE 0100-722 (Requirements for special installations or locations – Supplies for electric vehicles) specifies that all outlets for charging electric vehicles must be protected by a separate residual current device (RCD).

Furthermore, additional protection is required for multiphase charging with smooth DC fault current. Either a type B RCD, an RDC-DD (residual direct current detecting device) or an RCMB (residual current monitoring module) can be used to this end.

### Select Measuring Function

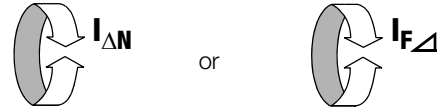

### Set Parameter – Type RDC

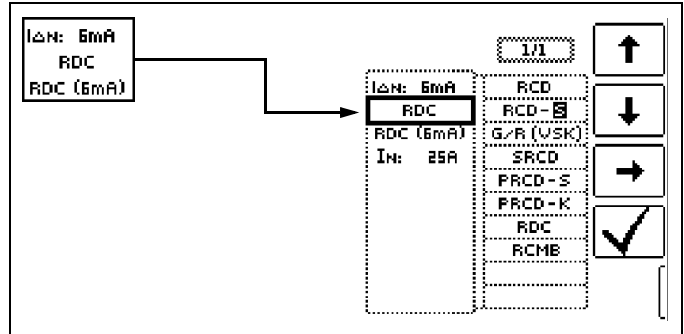

### Set Parameter – Time to Trip

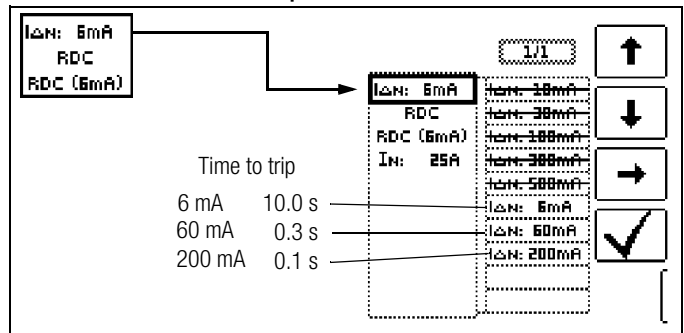

#### Note

The RDC-DD is tested with nominal residual currents of 6 to 200 mA.

### Start Measurement

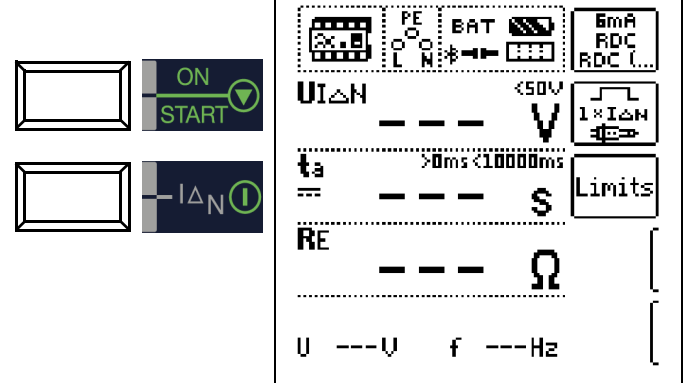

### Set Parameter – Type RCMB

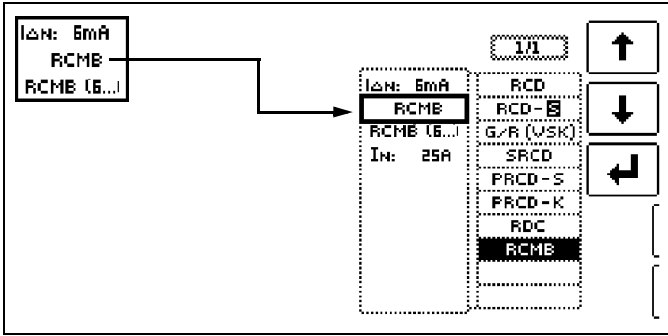

### Set Parameter – Time to Trip

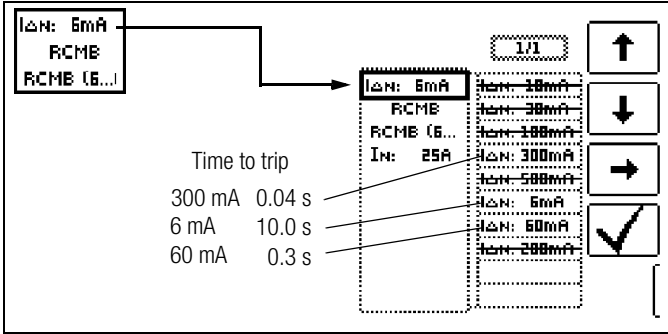

#### Note

The RCMB is tested with nominal residual currents of 6 to 300 mA.

### Start Measurement

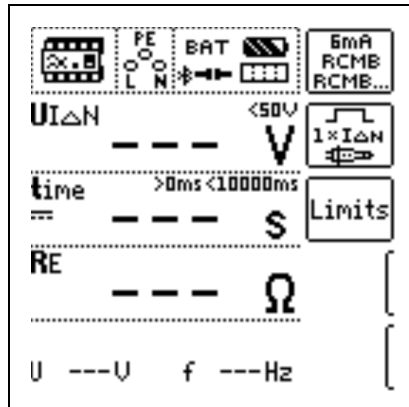

## 13 Testing of Breaking Requirements for Overcurrent Protective Devices, Measurement of Loop Impedance and Determination of Short-Circuit Current ( $Z_{L-PE}$ and $I_{SC}$ Functions)

Testing of overcurrent protective devices includes visual inspection and measurement.

### Measuring Method

Loop impedance  $Z_{L-PE}$  is measured and short-circuit current  $I_{SC}$  is ascertained in order to determine if the breaking requirements for protective devices have been fulfilled.

Loop impedance is the resistance within the current loop (utility station – phase conductor – protective conductor) when a short-circuit to an exposed conductive part occurs (conductive connection between phase conductor and protective conductor). Short-circuit current magnitude is determined by the loop impedance value. Short-circuit current  $I_{SC}$  may not fall below a predetermined value set forth by IEC 60364, so that reliable breaking of the protective device (fuse, automatic circuit breaker) is assured.

The measured loop impedance value must therefore be less than the maximum permissible value.

Tables containing permissible display values for loop impedance and minimum short-circuit current display values for ampere ratings for various fuses and circuit breakers can be found in the help texts and in section 25 from page 100. Maximum device error in accordance with IEC 61557 / EN 61557 has been taken into consideration in these tables. See also section 13.2.

In order to measure loop impedance  $Z_{L-PE}$ , the instrument uses a test current of 3.7 to 7 A (60 to 550 V) depending on line voltage and line frequency. At 16 Hz, The test has a duration of no more than 1200 ms.

**If the limit value for touch voltage is exceeded during this measurement process (> 50 V), safety shutdown occurs for Germany (65 V applies for Austria – standard: ÖVE/ÖNORM E 8001-1 section 5.3).**

**The shutdown value can be adjusted within a range of 25 to 65 V (see section 10.8).**

The test instrument calculates short-circuit current  $I_{SC}$  based on measured loop impedance  $Z_{L-PE}$  and line voltage. Short-circuit current calculation is made with reference to nominal line voltage for line voltages which lie within the nominal ranges for 120, 230 and 400 V systems. This also applies between phases L-L at 500 V. If line voltage does not lie within these nominal ranges, the instrument calculates short-circuit current  $I_{SC}$  based upon prevailing line voltage and measured loop impedance  $Z_{L-PE}$ .

### Select Measuring Function

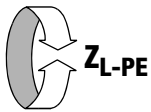

### Connection Schuko / 3-Pole Adapter

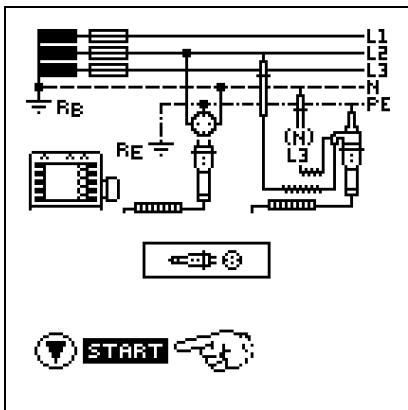

### Connection 2-Pole Adapter

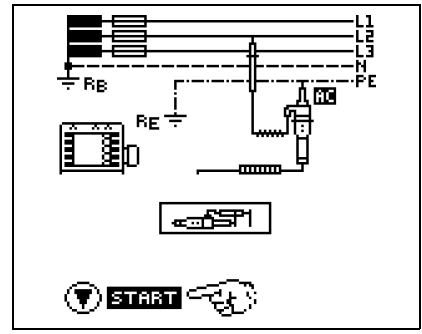

#### Note

Loop impedance should be measured for each electrical circuit at the farthest point, in order to ascertain maximum loop impedance for the system.

#### Note

Observe national regulations, e.g. the necessity of conducting measurements without regard for RCCBs in Austria.

### 3-Phase Connections

Measurement of loop impedance to earth must be performed at all three phase conductors (L1, L2, and L3) for the testing of overcurrent protective devices at three phase outlets.

### 13.1 Measurements with Suppression of RCD Tripping (PROFITEST MTECH+, PROFITEST MXTRA only)

The test instruments make it possible to measure loop impedance in TN systems with type A, F and AC RCCBs (10, 30, 100, 300, 500 mA nominal residual current).

The test instrument generates a direct current to this end, which saturates the RCCB's magnetic circuit.

The test instrument then superimposes a measuring current which only demonstrates half-waves of like polarity. The RCCB is no longer capable of detecting this measuring current and is consequently not tripped during measurement.

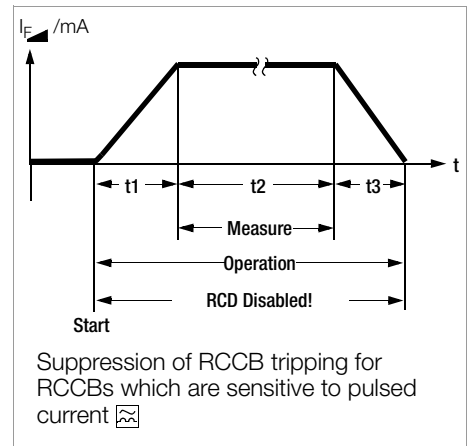

Suppression of RCCB tripping for RCCBs which are sensitive to pulsed current.

A four conductor measuring cable is used between the instrument and the test plug. Cable and measuring adapter resistance is automatically compensated during measurement and does not affect measurement results.

#### Note

Loop impedance measurement in accordance with the procedure for the suppression of RCCB tripping is only possible with type A and F RCDs.

#### Note

##### Bias Magnetization

Only AC measurements can be performed with the 2-pole adapter. Suppression of RCD tripping by means of bias magnetization with direct current is only possible via a country-specific plug insert, e.g. SCHUKO, or the 3-pole adapter (neutral conductor N required).

### 13.1.1 Measurement with Positive Half-Waves (PROFITEST MTECH+, PROFITEST MXTRA only)

Measurement by means of half-waves plus direct current makes it possible to measure loop impedance in systems which are equipped with RCCBs.

In the case of DC measurement with half-waves, selection can be made between two variants:

**DC-L:** Reduced bias current but faster measurement as a result

**DC-H:** Higher bias current providing more reliability with regard to non-tripping of the RCD

#### Select Measuring Function

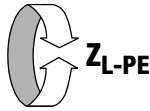

#### Set Parameters

IN 16A  
B/E(L)  
1.5 mm<sup>2</sup>

Nom. current: 2 ... 160 A, 9999 A

Tripping characteristics:  
A, B/L, C/G, D, E, H, K, GL/GG & factor

Diameter\*: 1.5 ... 70 mm

Cable type\*: NY..., H07...

Number of wires\*: 2 ... 10-wire

IN: 16A  
5 x IN(B/L)  
Ø: 1.5 mm<sup>2</sup>  
NYM-J  
3 -ADRIG

IN: 2.0A  
IN: 3.0A  
IN: 4.0A  
IN: 6.0A  
IN: 8.0A  
IN: 10A  
IN: 13A  
IN: 16A  
IN: 20A  
IN: 25A

\* Parameters used for report generation and do not influence the measurement

UL <50V  
DC

Touch voltage:  
Waveform:  
Sinusoidal  
15 mA sinusoidal  
DC-L and positive half-wave  
DC-H and positive half-wave

UL: <50V  
15mA  
DC-L  
DC-H

- Sinusoidal (full-wave)** Setting for circuit without RCD
- 15 mA sinusoidal** Setting for motor protection switch only with small nominal current
- DC + half-wave** Setting for circuit with RCD

Measurement with country-specific plug insert (e.g. Schuko)

L1-PE  
L1-PE

2-pole measurement

Note  
Selecting the test probe, as well as Lx-PE reference or AUTO, is only relevant with regard to report generation.

Polarity Selection

Semiautomatic measurement  
See also section 10.9 regarding the AUTO parameter.

#### Start Measurement

ON START

PE L N MEM  
UL <50V  
IK >120A  
Limits Ik: 2/3 Z  
L1-PE

U --- V f --- Hz

Semiautomatic measurement (conductor reference change)

L1-PE

U --- V f --- Hz

### 13.2 Evaluation of Measured Values

The maximum permissible loop impedance  $Z_{L-PE}$  which may be displayed after allowance has been made for the instrument's maximum measuring and intrinsic uncertainties (under normal measuring conditions) can be determined with the help of Table 1 on page 100. Intermediate values can be interpolated.

The maximum permissible nominal current for the protective device (fuse or circuit breaker) for a line voltage of 230 V after allowance has been made for maximum measuring error can be determined with the help of Table 6 on page 101 based on measured short-circuit current (corresponds to IEC 60364-6).

PE L N MEM  
ZL-PE 539 mΩ  
IK >120A 427 A  
Limits Ik: 2/3 Z  
L1-PE  
UN 230V fN 50.0Hz

### Special Case: Suppressing Display of the Limit Value

The limit value cannot be ascertained. The inspector is prompted to evaluate the measured values himself, and to acknowledge or reject them with the help of the softkeys.

Measurement passed:

key

Measurement failed:  key

The measured value can only be saved after it has been evaluated.

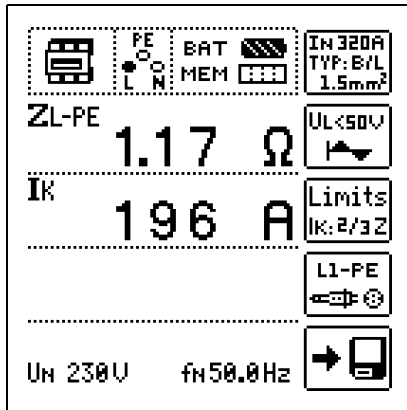
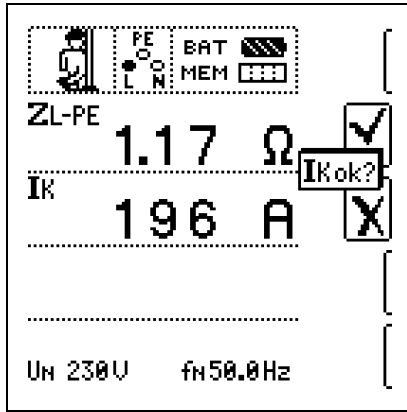

### 13.3 Settings for Calculating Short-Circuit Current – Parameter $I_{SC}$

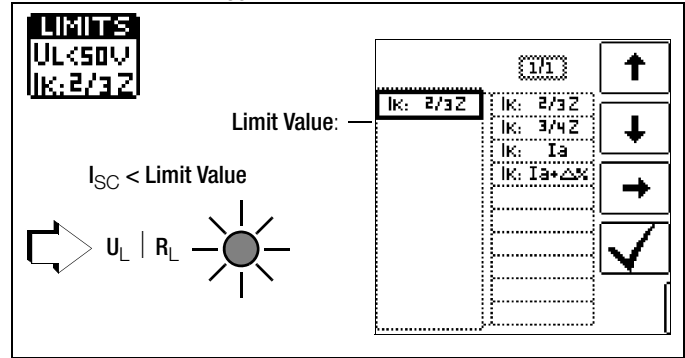

Short-circuit current  $I_{SC}$  is used to test shutdown by means of an overcurrent protective device. In order for an overcurrent protective device to be tripped on time, short-circuit current  $I_{SC}$  must be greater than tripping current  $I_a$  (see table 6 in section 25.1). The variants which can be selected with the “Limits” key have the following meanings:

- $I_{SC}$ :  $I_a$  The measured value displayed for  $I_{SC}$  is used without any correction to calculate  $Z_{L-PE}$ .
- $I_{SC}$ :  $I_a + \Delta\%$  The measured value displayed for  $Z_{L-PE}$  is corrected by an amount equal to the test instrument’s measuring and intrinsic uncertainties in order to calculate  $I_{SC}$ .
- $I_{SC}$ :  $2/3 Z$  In order to calculate  $I_{SC}$ , the measured value displayed for  $Z_{L-PE}$  is corrected by an amount corresponding to all possible deviations (these are defined in detail by IEC 60364-6 as  $Z_{s(m)} \leq 2/3 \times U_0/I_a$ ).
- $I_{SC}$ :  $3/4 Z$   $Z_{s(m)} \leq 3/4 \times U_0/I_a$

Z Loop impedance

$I_{SC}$  Short-circuit current

U Momentary voltage at the test probes, “ $U_N$ ” is displayed if  $U_{max}$  deviates from nominal voltage by 10%

f Frequency of the applied voltage, “ $f_N$ ” is displayed if frequency  $f_{max}$  deviates from nominal frequency by 1%

$I_a$  Tripping current (see data sheet for circuit breakers / fuses)

$\Delta\%$  Test instrument intrinsic error



# 14 Measuring Supply Impedance ( $Z_{L-N}$ Function)

## Measuring Method (internal line resistance measurement)

Supply impedance  $Z_{L-N}$  is measured by means of the same method used for loop impedance  $Z_{L-PE}$  (see section 13 on page 54). However, the current loop is completed via neutral conductor N rather than protective conductor PE as is the case with loop impedance measurement.

### Select Measuring Function

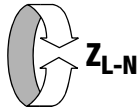

#### Connection Schuko

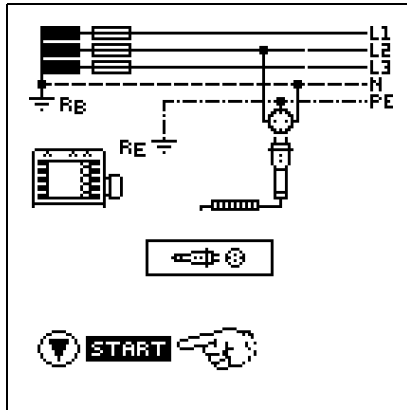

#### Connection 2-Pole Adapter

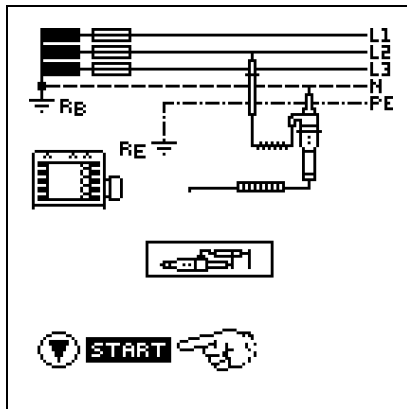

### Set Parameters

**IN 16A**  
E/E(L)  
1.5 mm<sup>2</sup>

Nom. current: 2 ... 160 A, 9999 A

**Tripping characteristics:**  
A, B/L, C/G, D, E, H, K, GL/GG & factor

**Diameters:** 1.5 ... 70 mm

**Cable type:** NY..., H07...

**Number of wires:** 2 ... 10-wire

IN: 16A	IN: 2.0A
IN: 2.0A	IN: 3.0A
IN: 3.0A	IN: 4.0A
IN: 4.0A	IN: 5.0A
IN: 5.0A	IN: 8.0A
IN: 8.0A	IN: 10A
IN: 10A	IN: 13A
IN: 13A	IN: 16A
IN: 16A	IN: 20A
IN: 20A	IN: 25A



Press the softkey shown at the left in order to switch back and forth between the country-specific plug insert, e.g. SCHUKO, and the 2-pole adapter. The selected connection type is displayed inversely (white on black).

01/03  
AUTO

**Polarity Selection**

- 1/1
- L1-N
- L2-N
- L3-N
- L1-L2
- L2-L3
- L1-L3
- AUTO
- L-N

**Semiautomatic Measurement**

See also section 10.9 regarding the **AUTO** parameter.  
L-PE relationships are not possible here.

### Settings for Calculating Short-Circuit Current – Parameter $I_{SC}$

**Limits**  $I_{SC}$

Limit Value: Ik: 2/3Z

$I_{SC} < \text{Limit Value}$

$U_L | R_L$

Ik: 2/3Z	Ik: 2/3Z
Ik: 3/4Z	Ik: 1a
Ik: 1a	Ik: 1a+Δ%

Short-circuit current  $I_{SC}$  is used to test shutdown by means of an overcurrent protective device. In order for an overcurrent protective device to be tripped on time, short-circuit current  $I_{SC}$  must be greater than tripping current  $I_a$  (see table 6 in section 25.1). The variants which can be selected with the "Limits" key have the following meanings:

- $I_{SC}$ :  $I_a$  The measured value displayed for  $I_{SC}$  is used without any correction to calculate  $Z_{L-N}$ .
- $I_{SC}$ :  $I_a + \Delta\%$  The measured value displayed for  $Z_{L-N}$  is corrected by an amount equal to the test instrument's measuring and intrinsic uncertainties in order to calculate  $I_{SC}$ .
- $I_{SC}$ : 2/3 Z In order to calculate  $I_{SC}$ , the measured value displayed for  $Z_{L-N}$  is corrected by an amount corresponding to all possible deviations (these are defined in detail by IEC 60364-6 as  $Z_{s(m)} \leq 2/3 \times U_0/I_a$ ).
- $I_{SC}$ : 3/4 Z  $Z_{s(m)} \leq 3/4 \times U_0/I_a$
- Z** Loop impedance
- $I_{SC}$**  Short-circuit current
- U** Momentary voltage at the test probes, "U<sub>N</sub>" is displayed if U<sub>max</sub> deviates from nominal voltage by 10%
- f** Frequency of the applied voltage, "fn" is displayed if frequency f<sub>max</sub> deviates from nominal frequency by 1%
- $I_a$**  Tripping current (see data sheet for circuit breakers / fuses)
- Δ%** Test instrument intrinsic error

## Start Measurement

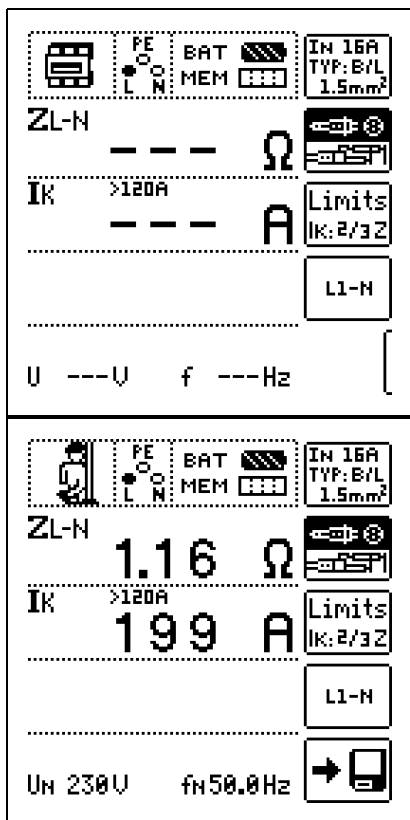

## Display of $U_{L-N}$ ( $U_N / f_N$ )

If the measured voltage value lies within a range of  $\pm 10\%$  of the respective nominal line voltage of 120, 230 or 400 V, the respectively corresponding nominal line voltage is displayed. In the case of measured values outside of the  $\pm 10\%$  tolerance, the actual measured value is displayed.

## Displaying the Fuse Table

After measurement has been performed, permissible fuse types can be displayed by pressing the **HELP** key.

The table shows maximum permissible nominal current dependent on fuse type and breaking requirements.



Ik: 199 A

Ik: 2/3Z

	In	gL/gG	In
A	40A	< 5s	25A
B/L	25A	< 0.4s	16A
E	20A	< 0.2s	16A
C/G	13A	< 1s	20A
D	6.0A		
K	8.0A		
H	50A		

**Key:**  $I_a$  = breaking current,  $I_{SC}$  = short-circuit current,  $I_N$  = nominal current,  $t_a$  = time to trip

## 15 Earthing Resistance Measurement (Function R<sub>E</sub>)

Earthing resistance R<sub>E</sub> is important for automatic shutdown in system segments. It must have a low value in order to assure that high short-circuit current flows and the system is shut down reliably by the RCCB in the event of a fault.

### Test Setup

Earthing resistance (R<sub>E</sub>) is the sum of the earth electrode's dissipation resistance and earth conductor resistance. Earthing resistance is measured by applying an alternating current via the earth conductor, the earth electrode and dissipation resistance. This current, as well as voltage between the earth electrode and a probe, are measured.

The probe is connected to the probe connector socket (17) with a 4 mm contact protected plug.

### Direct measurement with probe (mains powered earthing measurement)

Direct measurement of earthing resistance R<sub>E</sub> is only possible within a measuring circuit which includes a probe. However, this means that the probe and reference earth must be of like potential, i.e. that they are positioned outside of the potential gradient area. The distance between the earth electrode and the probe should be at least 20 m.

### Measurement without probe (mains powered earthing measurement)

In many cases, especially in extremely built-up areas, it's difficult, or even impossible, to set a measuring probe. In such cases, earthing resistance can be measured without a probe. In this case, however, the resistance values for the operational earth electrode R<sub>B</sub> and phase conductor L are also included in the measurement results.

### Measuring method (with probe) (mains powered earthing measurement)

The instrument measures earthing resistance R<sub>E</sub> by means of the ammeter-voltmeter test.

Resistance R<sub>E</sub> is calculated from the quotient of voltage U<sub>E</sub> and current I<sub>E</sub> where U<sub>E</sub> is between the earth electrode and the probe. The test current which is applied to earthing resistance is controlled by the instrument (see section 5.5, "Technical Data", on page 10 for pertinent values).

A voltage drop is generated which is proportional to earthing resistance.



#### Note

Measurement cable and measuring adapter resistance are compensated automatically during measurement and have no effect on measurement results.

If dangerous touch voltages occur during measurement (> 50 V), the measurement is interrupted and safety shutdown occurs.

Probe resistance does not affect measurement results and may be as high as 50 kΩ.



#### Attention!

The probe is part of the measuring circuit and may carry a current of up to 3.5 mA in accordance with IEC 61557 / EN 61557.

### Measurement with or without earth electrode voltage depending upon entered parameters and the selected type of connection:

RANGE	Connection	Measuring Functions
xx Ω / xx kΩ		No probe measurement No U <sub>E</sub> measurement
10 Ω / U <sub>E</sub> *		Probe measurement activated U <sub>E</sub> is measured
xx Ω / xx kΩ *		Probe measurement activated No U <sub>E</sub> measurement
		Clamp measurement activated No U <sub>E</sub> measurement

\* This parameter results in automatic selection of probe connection.

### Measuring method with suppression of RCD tripping (mains powered earthing measurement) (PROFITEST MTECH+, PROFITEST MXTRA only)

The test instrument makes it possible to measure earthing resistance in TN systems with type A , F and AC RCCBs (10, 30, 100, 300, 500 mA nominal residual current).

The test instrument generates a direct current to this end, which saturates the RCCB's magnetic circuit.

The test instrument then superimposes a measuring current which only demonstrates half-waves of like polarity. The RCCB is no longer capable of detecting this measuring current, and is consequently not tripped during measurement.

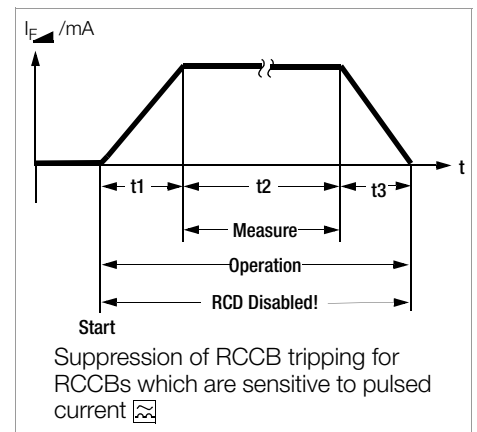

Suppression of RCCB tripping for RCCBs which are sensitive to pulsed current

A four conductor measuring cable is used between the instrument and the test plug. Cable and measuring adapter resistance is automatically compensated during measurement and does not affect measurement results.



#### Note

##### Bias Magnetization

Only AC measurements can be performed with the 2-pole adapter. Suppression of RCD tripping by means of bias magnetization with direct current is only possible via a country-specific plug insert, e.g. SCHUKO, or the 3-pole adapter (neutral conductor N required).

### Limit Values

Earthing resistance (earth coupling resistance) is determined primarily by the electrode's contact surface and the conductivity of the surrounding earth.

The specified limit value depends on the type of electrical system and its shutdown conditions in consideration of maximum touch voltage.

### Evaluating Measured Values

The maximum permissible displayed resistance values which assure that the required earthing resistance is not exceeded, and for which maximum device operating error has already been taken into consideration (at nominal conditions of use), can be determined with the help of Table 2 on page 100. Intermediate values can be interpolated.

## 15.1 Earthing Resistance Measurement – Mains Powered

The following types of measurement and connection are possible:

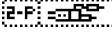
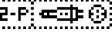
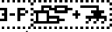
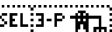
-  2-wire measurement via 2-pole adapter
-  2-pole measurement via earthing contact plug (not possible in IT systems)
-  3-wire measurement via 2-pole adapter and probe
-  Selective measurement: 2-pole measurement with probe and current clamp sensor

At left in figure:

2-pole measuring adapter for contacting PE and L measuring points



At right in figure:  
The PRO-Schuko measuring adapter can be used as an alternative.

### Select Measuring Function

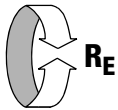

### Select Operating Mode



The selected operating mode is displayed inversely: mains~ in white against a black background.

### Special Case: Manual Measuring Range Selection (test current selection)

( $R \neq \text{AUTO}$ ,  $R = 10 \text{ k}\Omega$  (4 mA),  $1 \text{ k}\Omega$  (40 mA),  $100 \Omega$  (0,4 A),  $10 \Omega$  (3.7 ... 7 A),  $10 \Omega/U_E$ )

#### Note

When the measuring range is selected manually, accuracy values are only valid starting at 5% of the upper limit range value (except for the 10 W range; separate display for small values).

### Set Parameters

- Measuring range:** AUTO  
10 k $\Omega$  (4 mA), 1 k $\Omega$  (40 mA), 100  $\Omega$  (0.4 A), 10  $\Omega$  (> 3.7 A)  
In systems with RCCBs, resistance or test current must be selected such that it is less than tripping current ( $\frac{1}{2} I_{\Delta N}$ ).
- Touch voltage:** UL < 25 V, < 50 V, < 65 V, see section 10.8 regarding freely selectable voltage
- Transformer ratio:** depends on utilized current clamp sensor
- Connection:** 2-pole adapter, 2-pole adapter + probe, 2-pole adapter + clamp meter
- System type:** TN or TT
- Test current waveform**

See section 15.4 through section 15.6 regarding advisable parameters for the respective measurement and connection types.

### Performing Measurements

See section 15.4 through section 15.6.

## 15.2 Earthing Resistance Measurement – Battery Powered, “Battery Mode” (PROFITEST MPRO & PROFITEST MXTRA only)

The 5 following types of measurement and connection are possible:





-  3-wire measurement via PRO-RE adapter
-  4-wire measurement via PRO-RE adapter
-  Selective measurement with clamp meter (4-pole) via PRO-RE adapter
-  2-clamp measurement via PRO-RE/2 adapter
-  Measurement of soil resistivity  $\rho_E$  via PRO-RE adapter

Figure at right:

PRO-RE adapter for connecting earth electrode, auxiliary earth electrode, probe and auxiliary probe to the test instrument for 3/4-pole measurement, selective measurement and measurement of soil resistivity

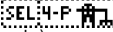

Figure at right:

PRO-RE/2 measuring adapter as accessory for connecting the E-Clip 2 generator clamp for 2-clamp measurement and earth loop resistance measurement.



### Select Measuring Function



### Select Operating Mode



The selected operating mode is displayed inversely: white battery icon against black background.

### Set Parameters

- Measuring range:** AUTO, 50 k $\Omega$ , 20 kW, 2 kW, 200 W, 20 W
- Current clamp sensor transformer ratio:**  
1:1 (1 V/A), 1:10 (100 mV/A), 1:100 (10 mV/A), 1:1000 (1 mV/A)
- Connection:** 3-pole, 4-pole, selective, 2-clamp,  $\rho_E$  (Rho)
- Distance d (for measuring  $\rho_E$ ):** xx m

See section 15.7 through section 15.11 regarding advisable parameters for the respective measurement and connection types.

### Performing Measurements

See section 15.7 through section 15.11.

### 15.3 Earthing Resistance, Mains Powered – 2-Pole Measurement with 2-Pole Adapter or Country-Specific Plug (Schuko) without Probe

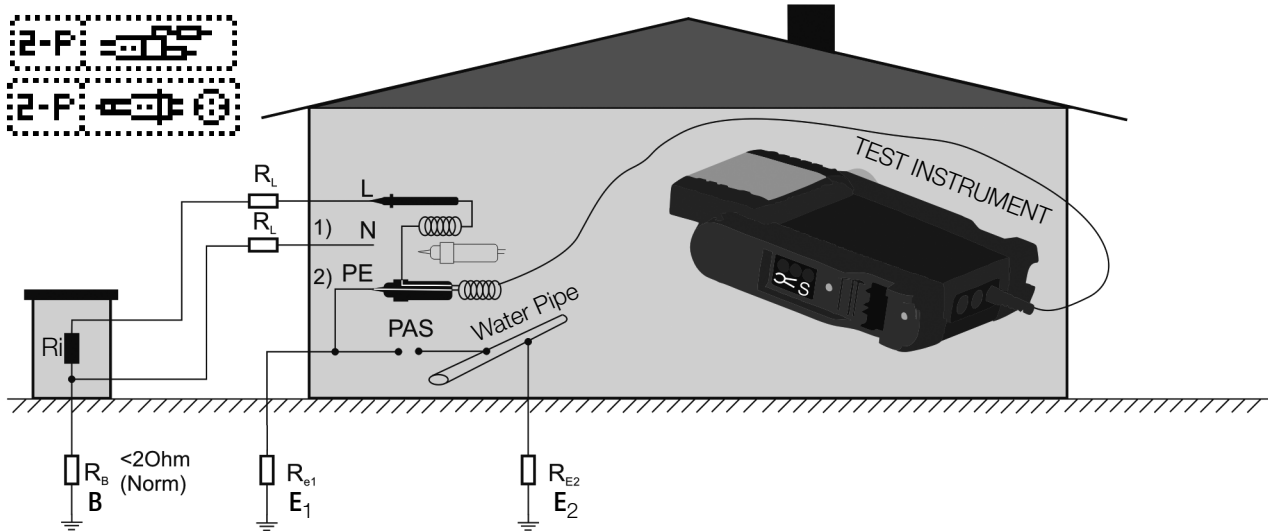

#### Key

- $R_B$  Operational earth electrode
- $R_E$  Earthing resistance
- $R_i$  Internal resistance
- $R_X$  Earthing resistance through equipotential bonding systems
- $R_S$  Probe resistance
- PAS Equipotential bonding busbar
- $R_{E_{loop}}$  Overall earthing resistance ( $R_{E1}/R_{E2}/\text{water pipe}$ )

In the event that it's impossible to set a probe, earthing resistance can be estimated by means of an "earth loop resistance measurement" without probe.

The measurement is performed exactly as described in section 15.4, "Earthing Resistance Measurement. Mains Powered – 3-Pole Measurement: 2-Pole Adapter with Probe", on page 62. However, no probe is connected to the probe connector socket (17).

The resistance value  $R_{E_{loop}}$  obtained with this measuring method also includes operational earth electrode resistance  $R_B$  and resistance at phase conductor L. These values must be subtracted from the measured value in order to determine earthing resistance.

If conductors of equal cross section are assumed (phase conductor L and neutral conductor N), phase conductor resistance is half as great as supply impedance  $Z_{L-N}$  (phase conductor + neutral conductor). Supply impedance can be measured as described in section 14 from page 57. In accordance with IEC 60364, the operational earth electrode  $R_B$  must lie within a range of "0  $\Omega$  to 2  $\Omega$ ".

- 1) Measurement:  $Z_{L-N}$  amounts to  $R_i = 2 \times R_L$
- 2) Measurement:  $Z_{L-PE}$  amounts to  $R_{E_{loop}}$
- 3) Calculation:  $R_{E1}$  amounts to  $Z_{L-PE} - \frac{1}{2} \times Z_{L-N}$ , where  $R_B = 0$

The value for operational earth conductor resistance  $R_B$  should be ignored in the calculation of earthing resistance, because it's generally unknown.

The calculated earthing resistance thus includes operational earth conductor resistance as a safety factor.

If the  parameter is selected, steps 1 through 3 are executed automatically by the test instrument.

#### Select Measuring Function



#### Select Operating Mode



#### Set Parameters

- Measuring range:** AUTO, 10 k $\Omega$  (4 mA), 1 k $\Omega$  (40 mA), 100  $\Omega$  (0.4 A), 10  $\Omega$  (3.7 ... 7 A). In systems with RCCBs, resistance or test current must be selected such that it is less than tripping current ( $\frac{1}{2} I_{\Delta N}$ ).
- Connection:** 2-Pole adapter
- Touch voltage:** UL < 25 V, < 50 V, < 65 V
- Test current waveshape:** Sinusoidal (full-wave), 15 mA sinusoidal (full-wave), DC offset and positive half-wave
- System type: TN/TT, IT
- Transformer ratio:** irrelevant in this case

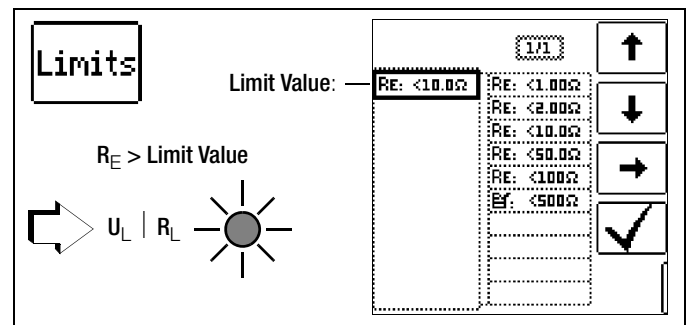

#### Start Measurement

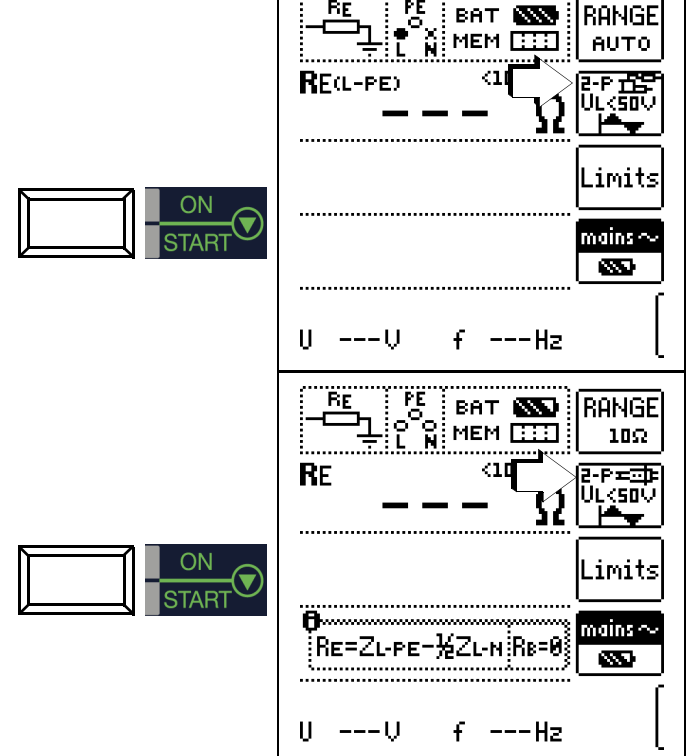

# 15.4 Earthing Resistance Measurement. Mains Powered – 3-Pole Measurement: 2-Pole Adapter with Probe

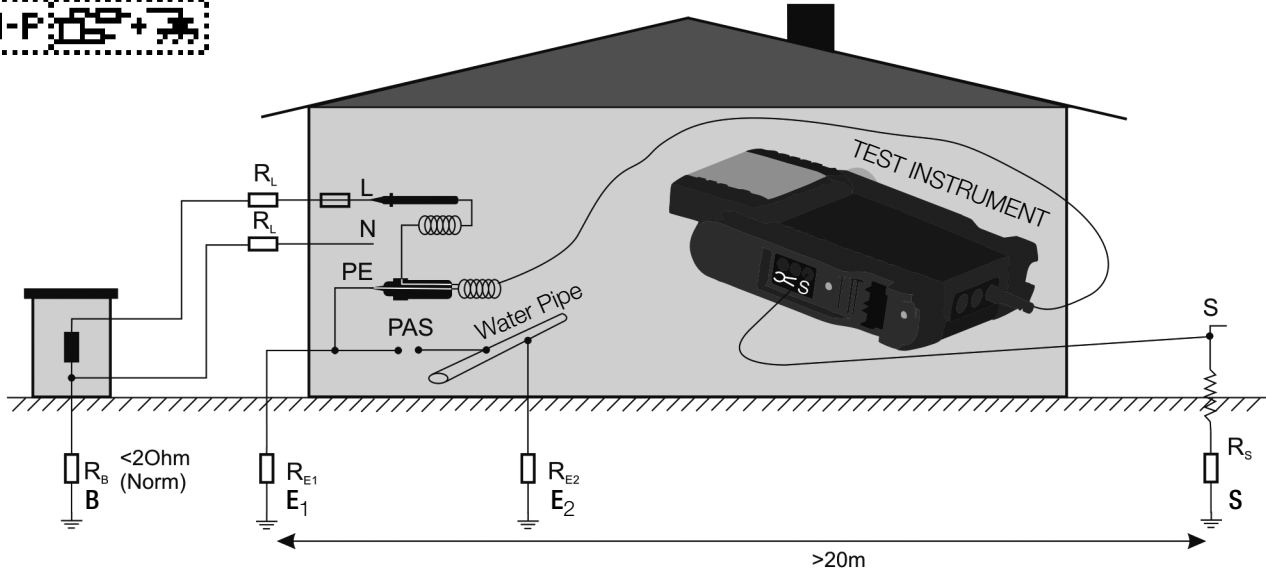

### Key

- $R_B$  Operational earth electrode
- $R_E$  Earthing resistance
- $R_X$  Earthing resistance through equipotential bonding systems
- $R_S$  Probe resistance
- PAS Equipotential bonding busbar
- $R_{E_{total}}$  Overall earthing resistance ( $R_{E1} // R_{E2} // \text{water pipe}$ )

Measurement of  $R_E$  ( $R_{E1} = \frac{U_{Probe}}{I}$ )

### Set Parameters

- Measuring range:** AUTO  
10 k $\Omega$  (4 mA), 1 k $\Omega$  (40 mA), 100  $\Omega$  (0.4 A), 10  $\Omega$  (3.7 ... 7 A)  
In systems with RCCBs, resistance or test current must be selected such that it is less than tripping current ( $\frac{1}{2} I_{\Delta N}$ ).
- Connection:** 2-pole adapter + probe
- Touch voltage:** UL < 25 V, < 50 V, < 65 V, see section 10.8 regarding freely selectable voltage
- Test current waveshape:**  
Sinusoidal (full-wave), 15 mA sinusoidal (full-wave), DC offset and positive half-wave
- System type:** TN/TT, IT
- Transformer ratio:** irrelevant in this case

### Select Measuring Function

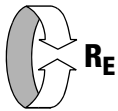

### Select Operating Mode



### Connection

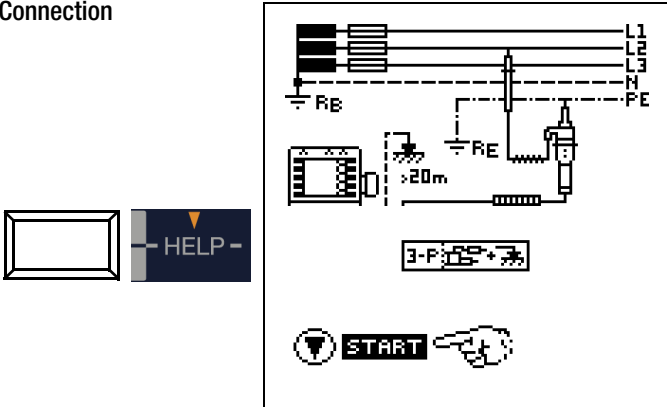

To be connected: 2-pole adapter and probe

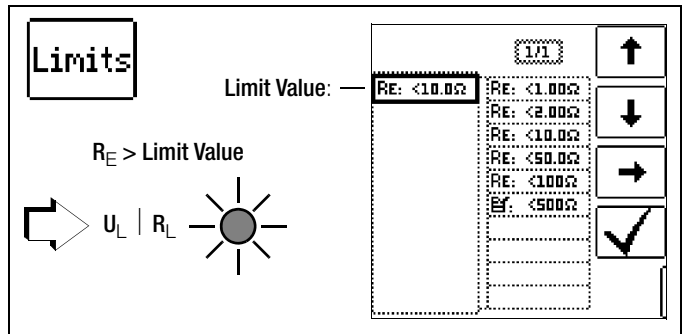

### Start Measurement

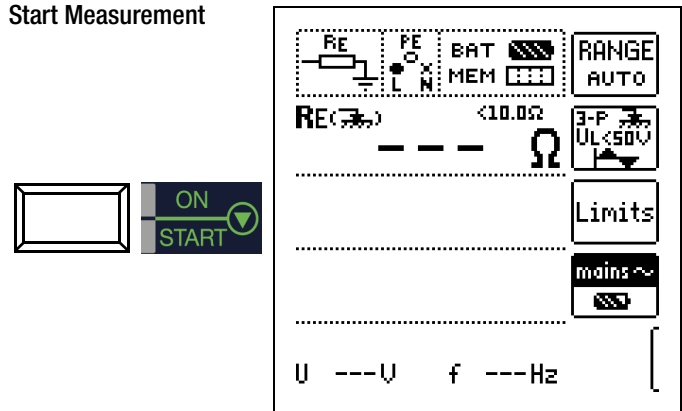

### Note

The following diagram appears if the 2-pole adapter is connected incorrectly.

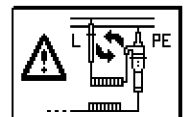

# 15.5 Earthing Resistance Measurement, Mains Powered – Measuring Earth Electrode Potential (U<sub>E</sub> Function)

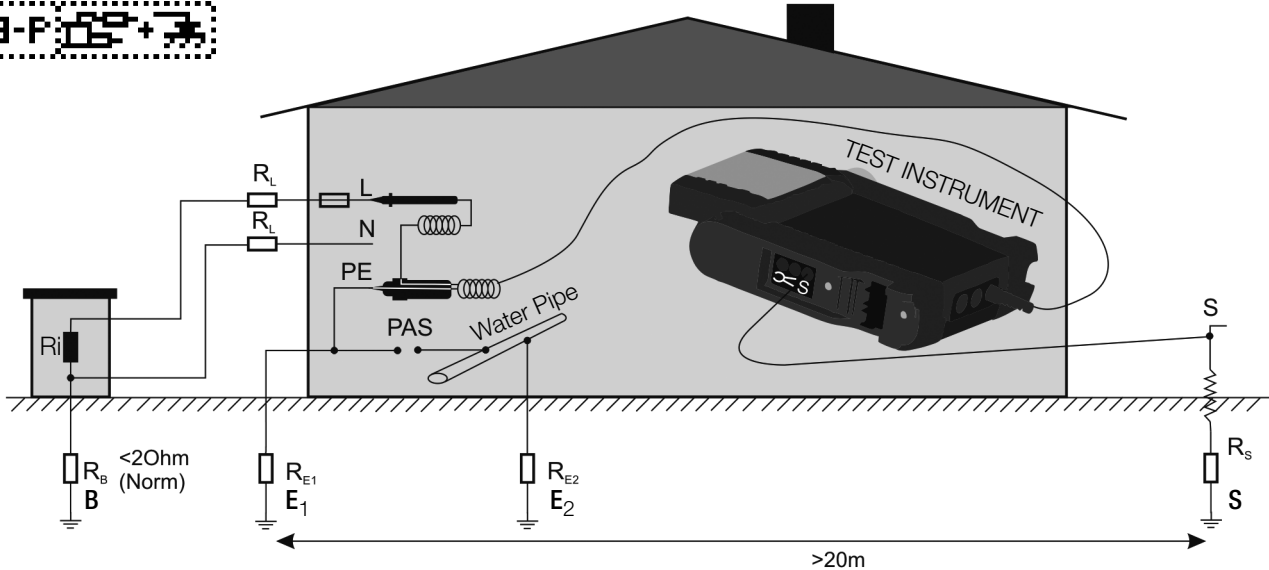

This measurement is only possible with a probe (see section 15.4). Earth electrode potential U<sub>E</sub> is the voltage which occurs at the earth electrode between the earth electrode terminal and reference earth if a short-circuit occurs between the phase conductor and the earth electrode. The measurement of earth electrode potential is required by Swiss standard NIV/NIN SEV 1000.

### Measuring Method

In order to determine earth electrode potential the instrument first measures earth electrode loop resistance R<sub>ELOOP</sub>, and immediately thereafter earthing resistance R<sub>E</sub>. The instrument stores both values and then calculates earth electrode potential with the following equation:

$$U_E = \frac{U_N \cdot R_E}{R_{ELOOP}}$$

The calculated value is displayed at the display panel.

### Select Measuring Function



### Select Operating Mode



### Select Measuring Range



### Connection

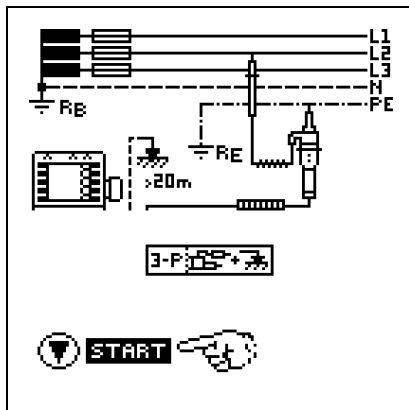

To be connected: 2-pole adapter and probe

### Set Parameters

- Measuring range:** 10 Ω / U<sub>E</sub>
- Connection:** 2-pole adapter + probe
- Touch voltage:** UL < 25 V, < 50 V, < 65 V, see section 10.8 regarding freely selectable voltage
- Test current waveshape:** sinusoidal only in this case (full-wave)!
- System type:** TN/TT, IT
- Transformer ratio:** irrelevant in this case

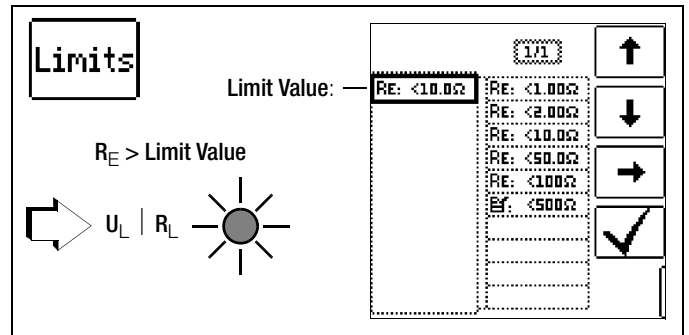

### Start Measurement

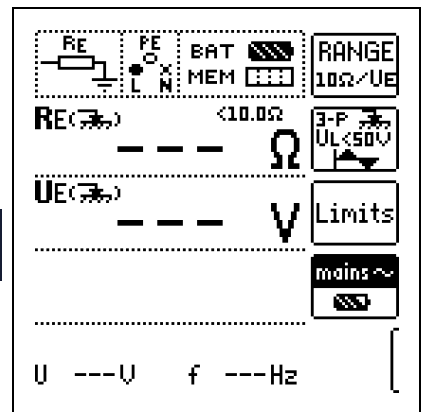

### Note

The following diagram appears if the 2-pole adapter is connected incorrectly.

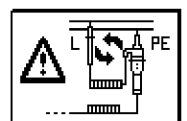

## 15.6 Earthing Resistance Measurement, Mains Powered – Selective Earthing Resistance Measurement with Current Clamp Sensor as Accessory

As an alternative to the conventional measuring method, measurement can also be performed with a current clamp sensor.

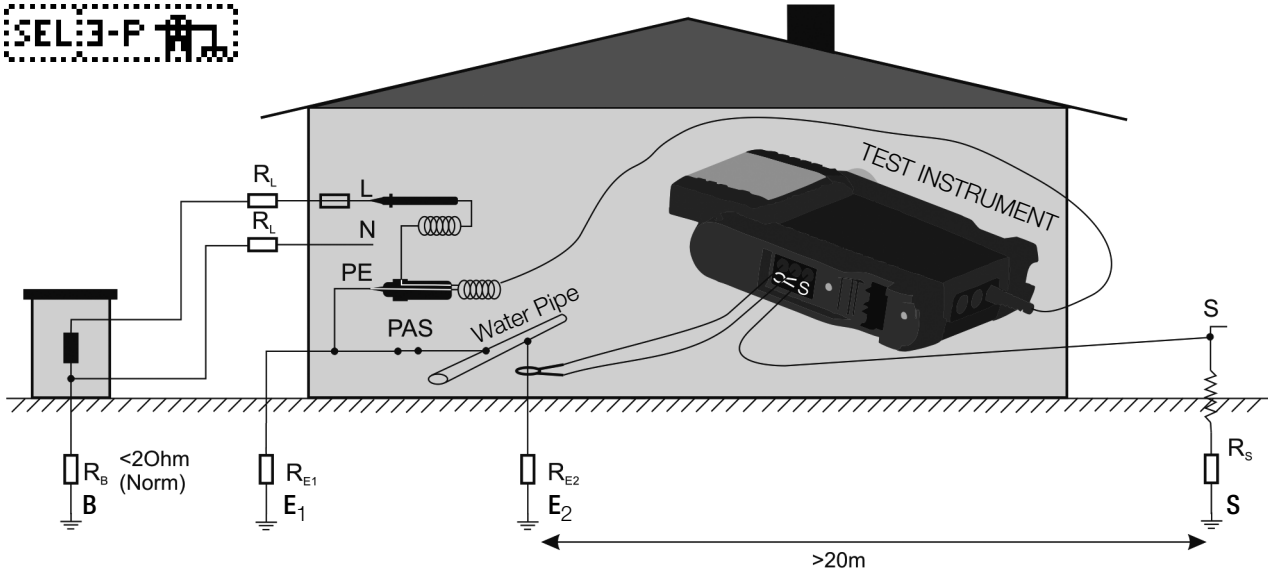

### Key

- $R_B$  Operational earth
- $R_E$  Earthing resistance
- $R_L$  Cable resistance
- $R_X$  Earthing resistance through equipotential bonding systems
- $R_S$  Probe resistance
- PAS Equipotential bonding busbar
- $R_E$  Overall earthing resistance ( $R_{E1} // R_{E2} // \text{water pipe}$ )

Measurement without clamp:  $R_E = R_{E1} // R_{E2}$

Measurement with clamp:  $R_E = R_{E2} = \frac{U_{\text{Probe}}}{I_{\text{Clamp}}}$

### Select Measuring Function



### Select Operating Mode



### Connection

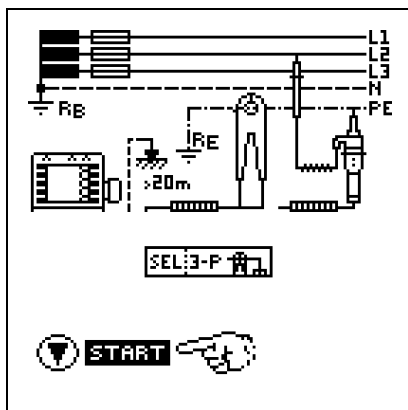

### Set Parameters at Tester

- Measuring range** (test current selection):  
1 k $\Omega$  (40 mA), 100  $\Omega$  (0.4 A), 10  $\Omega$  (3.7 ... 7 A)  
In the case of systems with RCCBs, the DC offset and positive half-wave (DC + ) functions can be selected (only in the 10  $\Omega$  range and only with the METRAFLEX P300).
- Connection:** 2-pole adapter + clamp meter  
After parameter selection: automatic setting to 10  $\Omega$  measuring range and 1 V/A or 1000 mV/A transformer ratio
- Touch voltage:** UL < 25 V, < 50 V, < 65 V, for information regarding freely selectable voltage see section 10.8
- Test current waveshape:** Sinusoidal (full-wave), DC offset and positive half-wave (DC + )
- System type:** TN/TT, IT
- Current clamp sensor transformation ratio:** see table below

### Set Parameters at Current Clamp Sensor

- Current clamp sensor measuring range:** see table below

### Select Measuring Range at the Current Clamp Sensor

Test Instrument Parameters Transformation Ratio	METRAFLEX P300 Clamp Switches	Test Instrument Measuring Range	Test Instrument Measuring Range
1:1 1 V / A	3 A (1 V/A)	<b>3 A</b>	0.5 ... 100 mA
01:10 100 mV / A	30 A (100 mV/A)	<b>30 A</b>	5 ... 999 mA
1:100 10 mV / A	300 A (10 mV/A)	<b>300 A</b>	0.05 ... 10 A

### Important Instructions for Use of the Current Clamp Sensor

- Use only the METRAFLEX P300 or the Z3512A current clamp sensor for this measurement.
- Read and adhere to the operating instructions for the METRAFLEX P300 current clamp sensor, as well as the safety precautions included therein.
- Observe direction of current flow (see arrow on the current clamp sensor).
- Use the clamp in the permanently connected state. The sensor may not be moved during measurement.
- The current clamp sensor may only be used at an adequate distance from powerful extraneous fields.
- Before use, always inspect the electronics housing, the connector cable and the current sensor for damage.
- In order to prevent electric shock, keep the surface of the METRAFLEX clean and free of contamination.
- Before use, make sure that the flexible current sensor, the connector cable and the electronics housing are dry.

To be connected: 2-pole adapter, clamp and probe



## Start Measurement

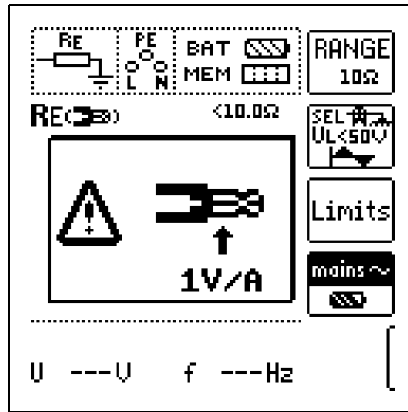

In the event that you have changed the transformation ratio at the test instrument, a pop-up window appears indicating that this new setting also has to be entered to the connected current clamp sensor.



### Note

Note regarding currently selected transformation ratio at the tester

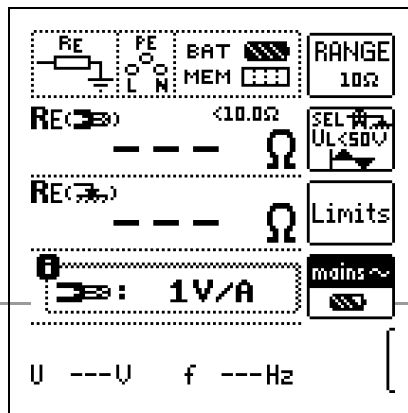

$RE_{Clamp}$ : Selective earthing resistance measured via clamp

$RE_{Probe}$ : Total earthing resistance measured via probe, comparative value



### Note

The following diagram appears if the 2-pole adapter is connected incorrectly.

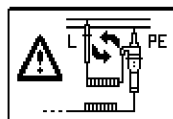

## 15.7 Earthing Resistance Measurement, Battery Powered, "Battery Mode" – 3-Pole (PROFITEST MPRO & PROFITEST MXTRA only)

### 3-Wire Method

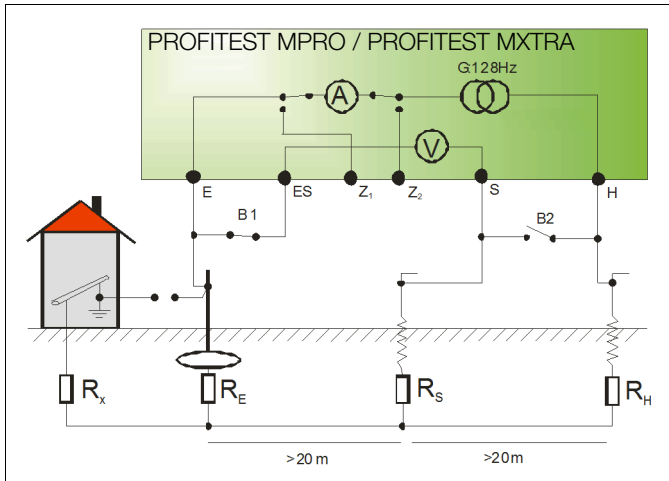

### Select Measuring Function



### Select Operating Mode



The selected operating mode is displayed inversely: white battery icon against black background.

### Set Parameters

- Measuring range: AUTO, 50 k $\Omega$ , 20 k $\Omega$ , 2 k $\Omega$ , 200  $\Omega$ , 20  $\Omega$
- Connection: 3-pin
- Transformer ratio: irrelevant in this case
- Distance d (for measuring  $\rho_E$ ): irrelevant in this case

### Earthing Resistance Measurement According to the 3-Wire Method

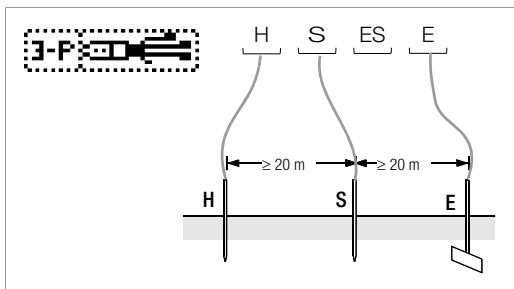

### Connection

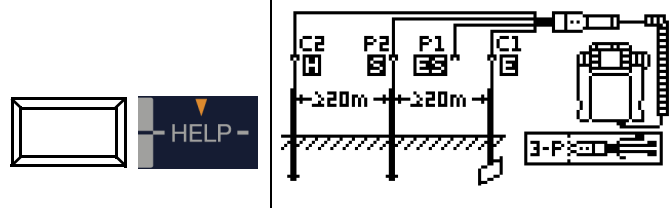

- Position the spikes for the probe and the auxiliary electrode at least 20, respectively 40 meters from the electrode (see figure above).
- Make sure that no excessively high contact resistances occur between the probe and the ground.
- Attach the PRO-RE adapter (Z501S) to the test plug.
- Connect the probe, the auxiliary electrode and the electrode via the 4 mm banana plug sockets at the PRO-RE adapter. In doing so, observe labeling on the banana plug sockets. Terminal ES/P1 is not connected.

The resistance of the measurement cable to the earth electrode is incorporated directly into the measurement results.

In order to keep error caused by measurement cable resistance as small as possible, a short connector cable with large cross-section should be used between the earth electrode and terminal E for this measuring method.

### Note

The measurement cables must be well insulated in order to prevent shunting. In order to keep the influence of possible coupling to a minimum, the measurement cables should not cross each other or run parallel to each other over any considerable distance.

### Start Measurement

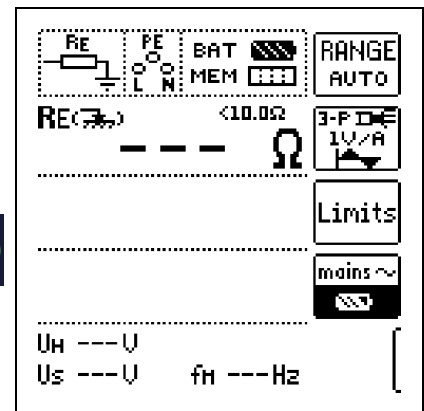

## 15.8 Earthing Resistance Measurement, Battery Powered, "Battery Mode" – 4-Pole (PROFITEST MPRO & PROFITEST MXTRA only)

### 4-Wire Method

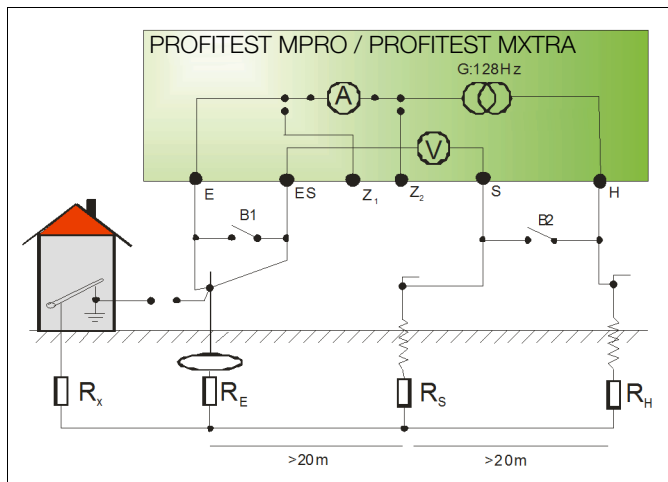

The 4-wire method is used in the case of high cable resistance between the earth electrode and the instrument terminal.

The resistance of the cable between the earth electrode and the "E" terminal at the instrument is measured in this case.

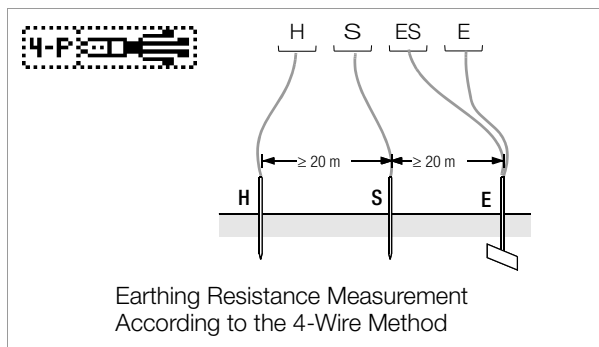

### Connection

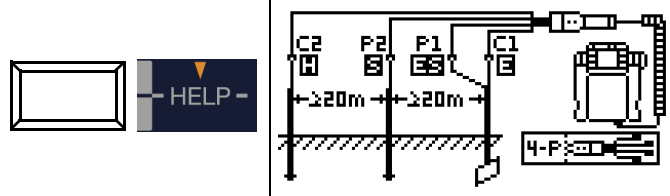

- Position the spikes for the probe and the auxiliary electrode at least 20, respectively 40 meters from the electrode (see figure above).
- Make sure that no excessively high contact resistances occur between the probe and the ground.
- Attach the **PRO-RE adapter (Z501S)** to the test plug.
- Connect the probes, the auxiliary electrode and the electrode via the 4 mm banana plug sockets at the **PRO-RE** adapter. In doing so, observe labeling on the banana plug sockets.

### Note

In the case of the 4-wire method, the earth electrode is connected to the "E" and "ES" terminals with two separate measurement cables, the probe is connected to the "S" terminal and the auxiliary earth electrode is connected to the "H" terminal.

### Note

The measurement cables must be well insulated in order to prevent shunting. In order to keep the influence of possible coupling to a minimum, the measurement cables should not cross each other or run parallel to each other over any considerable distance.

### Select Measuring Function



### Select Operating Mode



The selected operating mode is displayed inversely: white battery icon against black background.

### Set Parameters

- Measuring range:** AUTO, 50 k $\Omega$ , 20 k $\Omega$ , 2 k $\Omega$ , 200  $\Omega$ , 20  $\Omega$
- Connection:** 4-pin
- Transformer ratio:** irrelevant in this case
- Distance d (for measuring  $\rho_E$ ):** irrelevant in this case

### Start Measurement

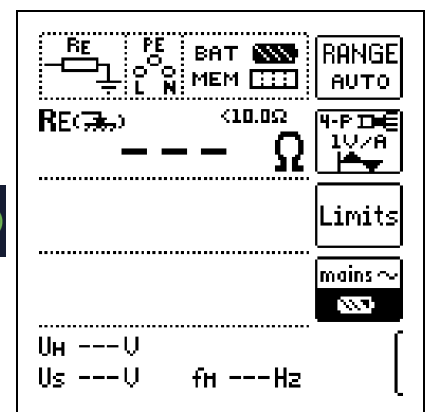

### Potential Gradient Area

Information regarding suitable positioning of the probe and the auxiliary earth electrode can be obtained by observing voltage characteristics or dissipation resistance in the ground.

The measuring current from the earth tester which flows via the earth electrode and the auxiliary earth electrode causes a given potential distribution in the form of a potential gradient area (cf. page 68). Resistance distribution is analogous to potential distribution.

Dissipation resistance of the earth electrode and the auxiliary earth electrode differs as a rule. The potential gradient area and the resistance gradient area are thus not symmetrical.

### Dissipation Resistance of Small Scope Earth Electrodes

The arrangement of the probe and the auxiliary earth electrode are very important for correct determination of the dissipation resistance of earth electrodes. The probe must be positioned between the earth electrode and the auxiliary earth electrode within the so-called neutral zone (reference earth) (cf. page 68). The voltage or resistance curve is thus nearly horizontal within the neutral zone.

Proceed as follows in order to select suitable probe and auxiliary earth electrode resistances:

- Drive the auxiliary earth electrode into the ground at a distance of roughly 40 meters from the earth electrode.
- Position the probe halfway between the earth electrode and the auxiliary earth electrode and determine earthing resistance.
- Reposition the probe 2 ... 3 m closer to the earth electrode, and then 2 ... 3 m closer to the auxiliary earth electrode and measure earthing resistance in each position.

If all 3 measurements result in the same measured value, this is the correct earthing resistance. The probe is in the neutral zone. However, if the three measured values for earthing resistance differ from each other, either the probe is not located in the neutral

zone, or the voltage or resistance curve is not horizontal at the point at which the probe has been inserted.

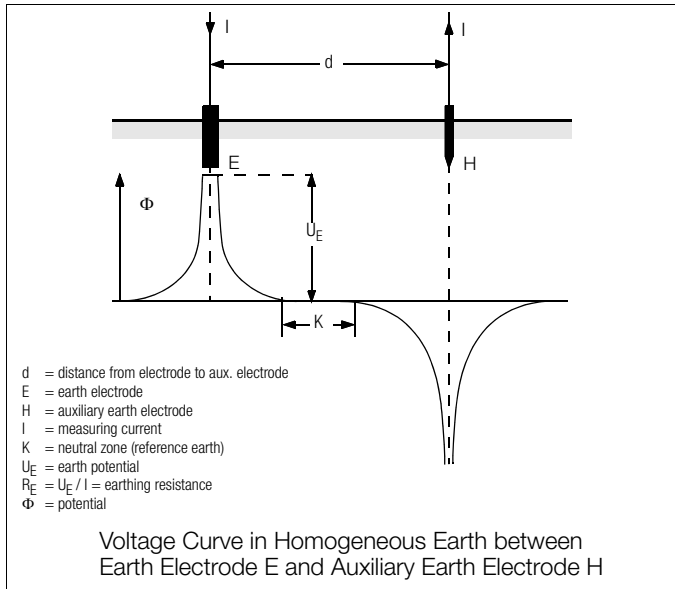

Correct measurements can be obtained in such cases by either increasing distance between the earth electrode and the auxiliary earth electrode, or by moving the probe to the perpendicular bisector between the earth electrode and the auxiliary earth electrode (see figure below). When the probe is moved to the perpendicular bisector, its location is removed from the sphere of influence of the two potential gradient areas caused by the earth electrode and the auxiliary earth electrode.

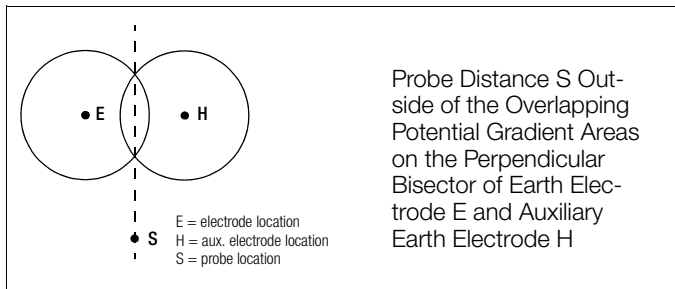

### Dissipation Resistance of Large Scope Earthing Systems

Significantly large distances to the probe and the auxiliary earth electrode are required for measuring large scope earthing systems. Calculations are based on 2½ or 5 times the value of the earthing system's largest diagonal. Large scope earthing systems of this sort often demonstrate dissipation resistances of only a few ohms, which makes it especially important to position the measuring probe within the neutral zone. The probe and the auxiliary earth electrode should be positioned at a right angle to the direction of the earthing system's largest linear expansion. Dissipation resistance must be kept small. If necessary, several earth spikes must be used at a distance of 1 to 2 m from each other and connected to this end. However, in actual practice large measuring distances are frequently not possible to due difficult terrain. If this is the case, proceed as shown in figure "Earthing Resistance Measurement for a Large Scope Earthing System" on page 68.

- Auxiliary earth electrode H is positioned as far as possible from the earthing system.
- The area between the earth electrode and the auxiliary earth electrode is sampled with the probe in equal steps of 5 meters each.
- Measured resistance values are displayed as a table, and then plotted graphically as depicted in "Earthing Resistance Measurement for a Large Scope Earthing System" on page 68. (Curve I).

If a line parallel to the abscissa is drawn through inflection point S1, this line divides the resistance curve into two parts. Measured at the ordinate, the bottom part results in sought dissipation resistance of the earth electrode  $R_{A/E}$ , and the top value is dissipation resistance of the auxiliary earth electrode  $R_{A/H}$ . With a measurement setup of this type, dissipation resistance of the auxiliary earth electrode should be less than 100 times the dissipation resistance of the earth electrode.

In the case of resistance curves without a well-defined horizontal area, measurement should be double checked after repositioning the auxiliary earth electrode. This additional resistance curve must be entered to the first diagram with a modified abscissa scale such that the two auxiliary earth electrode locations are superimposed. The initially ascertained dissipation resistance value can be checked with inflection point S2.

### Notes Regarding Measurement in Difficult Terrain

In extremely unfavorable terrain (e.g. sandy soil after a lengthy period without rain), auxiliary earth electrode and probe resistance can be reduced to permissible values by watering the ground around the auxiliary earth electrode and the probe with soda water or salt water.

If this does not suffice, several earth spikes can be parallel connected to the auxiliary earth electrode.

In mountainous terrain or in the case of very rocky subsoil where earth spikes cannot be driven into the ground, wire grates with a mesh size of 1 cm and a surface area of about 2 square meters can be used. These grates are laid flat onto the ground, are wetted with soda water or salt water and may also be weighted down with sacks full of moist earth.

Curve I (KI)		Curve II (KII)	
m	W	m	W
5	0.9	10	0.8
10	1.28	20	0.98
15	1.62	40	1.60
20	1.82	60	1.82
25	1.99	80	2.00
30	2.12	100	2.05
40	2.36	120	2.13
60	2.84	140	2.44
80	3.68	160	2.80
100	200	200	100

S1, S2 = inflection points  
KI = curve I  
KII = curve II

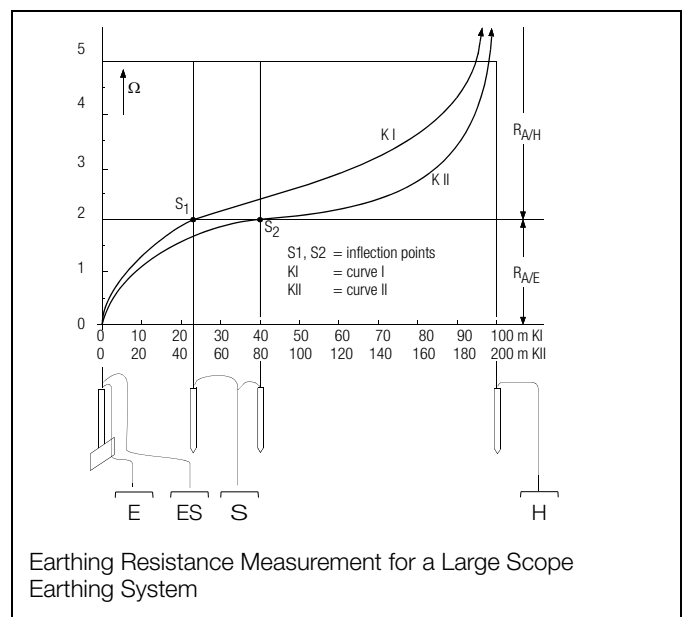

## 15.9 Earthing Resistance Measurement, Battery Powered, "Battery Mode" – Selective (4-pole) with Current Clamp Sensor and PRO-RE Measuring Adapter as Accessory (PROFITEST MPRO & PROFITEST MXTRA only)

### General

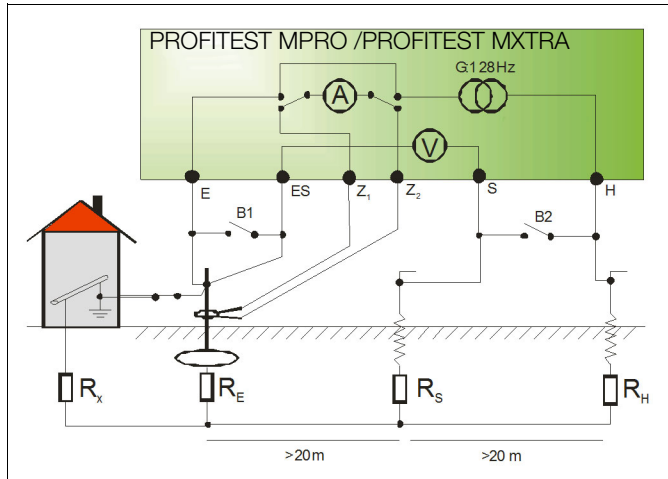

When measuring earthing resistance in systems with several parallel connected earth electrodes, total resistance of the earthing system is measured.

Two earth spikes (auxiliary earth electrode and probe) are set for this measurement. Measuring current is fed between the earth electrode and the auxiliary earth electrode and voltage drop is measured between the earth electrode and the probe.

The current clamp is positioned around the earth electrode to be measured, and thus only that portion of the measuring current which flows through the earth electrode is measured.

### Connection

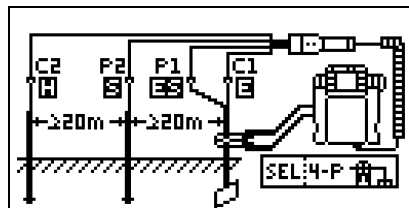

- Position the spikes for the probe and the auxiliary electrode at least 20, respectively 40 meters from the electrode (see figure above).
- Make sure that no excessively high contact resistances occur between the probe and the ground.
- Attach the PRO-RE adapter (Z501S) to the test plug.
- Connect the probes, the auxiliary electrode and the electrode via the 4 mm banana plug sockets at the PRO-RE adapter. In doing so, observe labeling on the banana plug sockets.
- Connect the Z3512A current clamp sensor to jacks (15) and (16) at the test instrument.
- Attach the current clamp sensor to the earth electrode.

### Select Measuring Function



### Select Operating Mode



The selected operating mode is displayed inversely: white battery icon against black background.

### Set Parameters at Tester

- ☐ Measuring range: 200  $\Omega$

### Note

After switching to selective measurement, the **AUTO** measuring range is activated automatically if a measuring range of greater than 200  $\Omega$  had been selected.

- ☐ Connection type: selective
- ☐ Current clamp sensor transformer ratio: 1:1 (1 V/A), 1:10 (100 mV/A), 1:100 (10 mV/A)
- ☐ Distance  $d$  (for measuring  $\rho_E$ ): irrelevant in this case

### Set Parameters at Current Clamp Sensor

- ☐ Current clamp sensor measuring range: see table below

### Select Measuring Range at the Current Clamp Sensor

Test Instrument Parameters Transformation Ratio	Z3512A Clamp	
	Switches	Measuring Range
1:1 1 V / A	1 A / $\times 1$	1 A
01:10 100 mV / A	10 A / $\times 10$	10 A
1:100 10 mV / A	100 A / $\times 100$	100 A

### Important Instructions for Use of the Current Clamp Sensor

- Use only the Z3512A current clamp sensor for this measurement.
- Use the clamp in the permanently connected state. The sensor may not be moved during measurement.
- The current clamp sensor may only be used at an adequate distance from powerful extraneous fields.
- Make sure that the current clamp sensor's connector cable is laid separate from the probe cables to the greatest possible extent.

### Start Measurement

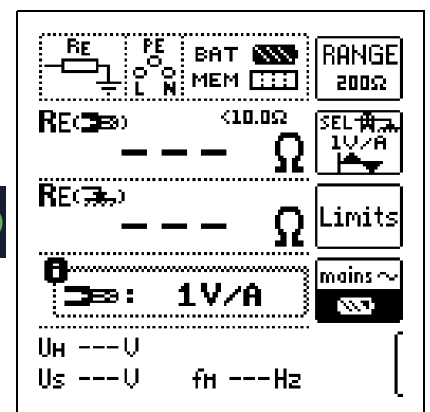

# 15.10 Earthing Resistance Measurement, Battery Powered, "Battery Mode" – Ground Loop Measurement (with current clamp sensor and transformer, and pro-re measuring adapter as accessory) (PROFITEST MPRO & PROFITEST MXTRA only)

## 2-Clamp Measuring Method

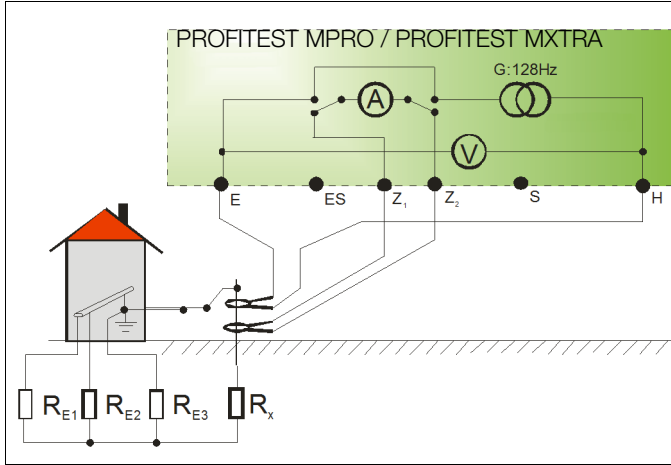

In the case of earthing systems which consist of several earth electrodes (R1 ... Rx) which are connected to each other, earthing resistance of a single electrode (Rx) can be ascertained with the help of 2 current clamps without disconnecting Rx or using spikes.

This measuring method is especially well suited for buildings or systems for which probes and auxiliary earth electrodes cannot be used, or where it's impermissible to disconnect earth electrodes.

Furthermore, this "spike-free" measurement is performed as one of three measurements for lightning protection systems, in order to determine whether or not current can be dissipated.

Figure at right: PRO-RE/2 measuring adapter as accessory for connecting the E-Clip 2 generator current clamp

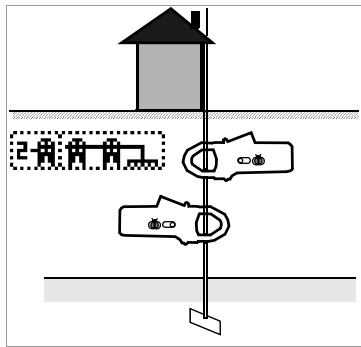

## Connection

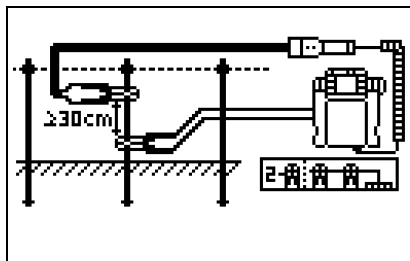

- No probes or auxiliary earth electrodes are required.
- The earth electrode is not disconnected.
- Attach the PRO-RE/2 adapter (Z502T) to the test plug.
- Connect the E-Clip 2 generator clamp (current clamp transformer) via the 4 mm safety plugs at the PRO-RE/2 adapter.
- Connect the Z3512A current clamp sensor to jacks 15 and 16 at the test instrument.
- Attach the 2 clamps to an earth electrode (earth spike) at different heights with a clearance of at least 30 cm.

## Select Measuring Function

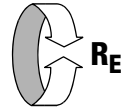

## Select Operating Mode



The selected operating mode is displayed inversely: white battery icon against black background.

## Set Parameters at Tester

- Measuring range: in this case always AUTO



### Note

After selecting 2-clamp measurement, switching to the AUTO range takes place automatically. It is then no longer possible to change the range!

- Connection: 2 clamps
- Current clamp sensor transformer ratio: 1:1 (1 V/A), 1:10 (100 mV/A), 1:100 (10 mV/A)
- Distance d (for measuring  $\rho_E$ ): irrelevant in this case

## Set Parameters at Current Clamp Sensor

- Current clamp sensor measuring range: see table below

## Select Measuring Range at the Current Clamp Sensor

Test Instrument Parameters Transformation Ratio	Z3512A Clamp	
	Switches	Measuring Range
1:1 1 V / A	1 A / × 1	1 A
01:10 100 mV / A	10 A / × 10	10 A
1:100 10 mV / A	100 A / × 100	100 A

## Important Instructions for Use of the Current Clamp Sensor

- Use only the Z3512A current clamp sensor for this measurement.
- Use the clamp in the permanently connected state. The sensor may not be moved during measurement.
- The current clamp sensor may only be used at an adequate distance from powerful extraneous fields.
- Make sure that the connector cables from the two clamps are laid separate from each other to the greatest possible extent.

## Start Measurement

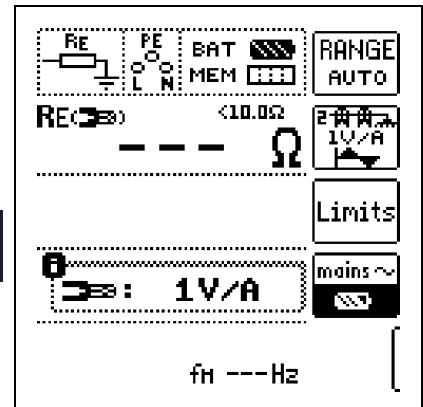

## 15.11 Earthing Resistance Measurement, Battery Powered, "Battery Mode" – Measurement of Soil Resistivity $\rho_E$ (PROFITEST MPRO & PROFITEST MXTRA only)

### General

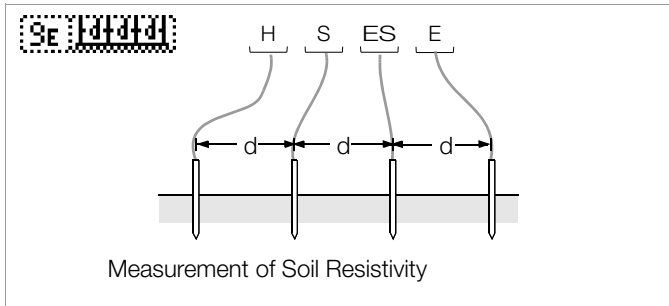

The determination of soil resistivity is necessary for the planning of earthing systems. Reliable values need to be ascertained which take even the worst possible conditions into account (see „Geologic Evaluation“ on page 71).

Soil resistivity is decisive with regard to the magnitude of an earth electrode's dissipation resistance. Soil resistivity can be measured with the test instrument using the method according to Wenner. Four earth spikes of greatest possible length are driven into the ground in a straight line at distance  $d$  from one another, and are connected to the earth tester (see figure above). The earth spikes usually have a length of 30 to 50 cm. Longer earth spikes can be used for soil which demonstrates poor conductivity (sandy soil etc.). The depth to which the earth spikes are driven into the ground may not exceed one twentieth of distance  $d$ .

#### Note

Erroneous measurement may result if piping, cables or other underground metal conduits run parallel to the measuring setup.

Soil resistivity is calculated as follows:

$$\rho_E = 2\pi \cdot d \cdot R$$

Where:

$$\pi = 3.1416$$

$d$  = distance in m between two earth spikes

$R$  = ascertained resistance value in  $\Omega$  (this value corresponds to  $R_E$  as determined with the 4-wire method)

### Connection

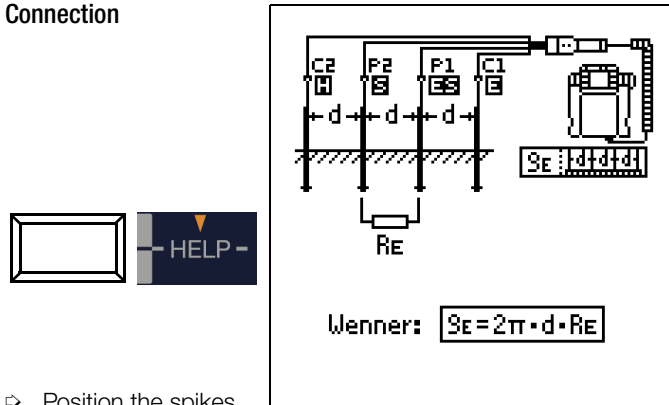

- Position the spikes for the probe and the auxiliary electrode at equal distances (see figure above).
- Make sure that no excessively high contact resistances occur between the probe and the ground.
- Attach the PRO-RE adapter (Z501S) to the test plug.
- Connect the probes, the auxiliary electrode and the electrode via the 4 mm banana plug sockets at the PRO-RE adapter. In doing so, observe labeling on the banana plug sockets.

### Select Measuring Function

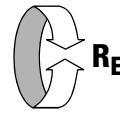

### Select Operating Mode



The selected operating mode is displayed inversely: white battery icon against black background.

### Set Parameters

- Measuring range:** AUTO, 50 k $\Omega$ , 20 k $\Omega$ , 2 k $\Omega$ , 200  $\Omega$ , 20  $\Omega$
- Connection:**  $\rho_E$  (Rho)
- Transformer ratio:** irrelevant in this case
- Distance  $d$  for measurement of  $\rho_E$ :** adjustable from 0.1 to 999

### Start Measurement

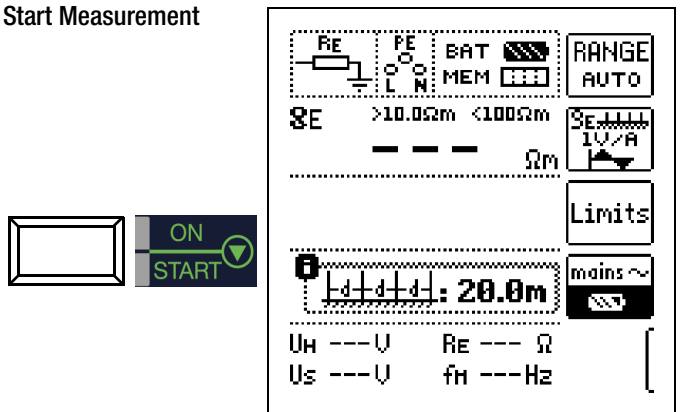

### Geologic Evaluation

Except in extreme cases, the ground is measured down to a depth which is roughly equal to probe distance  $d$ . And thus it's possible to arrive at conclusions regarding the ground's stratification by varying probe distance. Layers which are highly conductive (water table) into which earth electrodes should be installed, can thus be discovered within a region which is otherwise not very conductive.

Soil resistivity is subject to considerable fluctuation which may be due to various causes such as porosity, moisture penetration, concentration of dissolved salts in the ground water and climatic fluctuation.

Characteristic values for  $\rho_E$  relative to season (soil temperature and the soil's negative temperature coefficient) can be approximated quite closely by means of a sinusoidal curve.

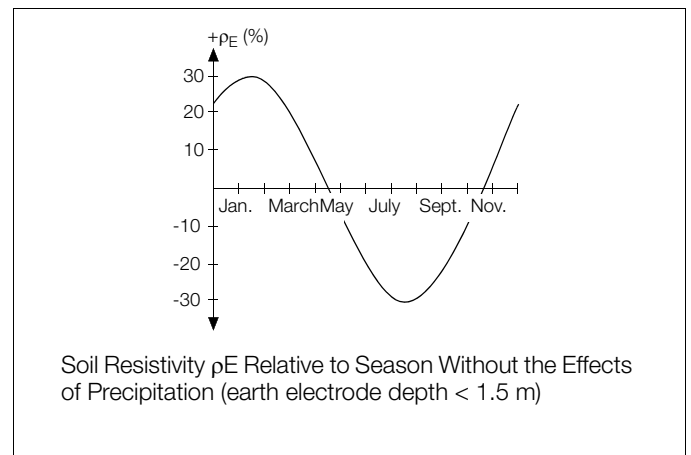

A number of typical soil resistivity values for various types of ground are summarized in the following table.

Type of Soil	Soil Resistivity $\rho_E$ [ $\Omega\text{m}$ ]
Marshy ground	8 ... 60
Arable soil, loamy and clayey soil, moist gravel	20 ... 300
Moist sandy soil	200 ... 600
Dry sandy soil, dry gravel	200 ... 2000
Rocky ground	300 ... 8000
Rock	$10^4$ ... $10^{10}$

### Calculating Dissipation Resistance

Formulas for calculating dissipation resistance for common types of earth electrodes are included in this table.

These rules of thumb are entirely adequate for actual practice.

Number	Earth Electrode	Rule of Thumb	Subsidiary Variable
1	Earth strip (star type earth electrode)	$R_A = \frac{2 \cdot \rho_E}{l}$	—
2	Earth rod (buried earth electrode)	$R_A = \frac{\rho_E}{l}$	—
3	Ring earth electrode	$R_A = \frac{2 \cdot \rho_E}{3D}$	$D = 1,13 \cdot \sqrt[2]{F}$
4	Mesh earth electrode	$R_A = \frac{2 \cdot \rho_E}{2D}$	$D = 1,13 \cdot \sqrt[2]{F}$
5	Ground plate	$R_A = \frac{2 \cdot \rho_E}{4,5 \cdot a}$	—
6	Hemispherical earth electrode	$R_A = \frac{\rho_E}{\pi \cdot D}$	$D = 1,57 \cdot \sqrt[3]{J}$

$R_A$  = dissipation resistance ( $\Omega$ )

$\rho_E$  = soil resistivity ( $\Omega\text{m}$ )

$l$  = length of the earth electrode (m)

$D$  = diameter of a ring earth electrode, diameter of the equivalent surface area of a mesh earth electrode or diameter of a hemispherical earth electrode (m)

$F$  = surface area (sq. meters) of the enclosed surface or a ring or mesh earth electrode

$a$  = Edge length (m) of a square ground plate;  $a$  is replaced with the following for rectangular plates:  $\sqrt{b \times c}$ , where  $b$  and  $c$  are the two sides of the rectangle.

$J$  = volume (cubic meters) of an individual foundation footing



## 16 Measurement of Insulation Resistance



### Attention!

Insulation resistance may only be measured at voltage-free devices.

### 16.1 General

#### Select Measuring Function



#### Connection

2 pole adapter or test plug

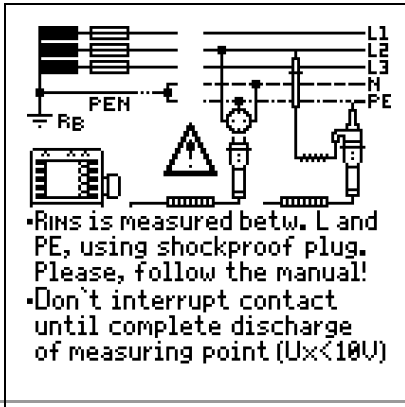

#### Note

The test instrument always measures insulation between the L and PE terminals.  
 N and PE must be interrupted for systems without RCD.



#### Note

**Checking Measurement Cables Before Measurements**  
 Before performing insulation measurement, the test probes on the measurement cables should be short-circuited in order to assure that the instrument displays a value of less than 1 kΩ. In this way, incorrect connection can be avoided and interrupted measurement cables can be detected.

#### Set Parameters

500V U<sub>INS</sub> Test voltage: 15, 50, 100, 250, 325, 500, 1000 V  
 xxx V\*

500V U<sub>INS</sub>

Voltage type: constant

Voltage type: rising/ramp

Earth leakage resistance:

\* Freely adjustable voltage (see section 10.8)

#### Polarity Selection

L1-PE 2-pole measurement (selection relevant for report generation only): measurements between Lx-PE / N-PE / L+N-PE / Lx-N / Lx-Ly / AUTO\*  
 where x, y = 1, 2, 3

\* AUTO parameter (see section 10.9)

#### Breakdown Current for Ramp Function

I<sub>LIM</sub> 1.00mA U<sub>INS</sub> (U<sub>INS</sub>)

Limit Value: I: 1.00mA I: 50µA I: 500µA I: 1.00mA I: 1.25mA Eff: 750µA

I > I<sub>Limit</sub> STOP



#### Note

In order to suppress the influence of parallel capacitances on the device under test when measurement is started, shutdown at the respective breakdown current I<sub>lim</sub> does not occur until a minimum voltage of 5 V is exceeded.

#### Limit Values for Breakdown Voltage

Limits U<sub>INS</sub> (U<sub>INS</sub>)

Lower limit value: U: >250V Eff: >250V

Upper limit value: U: <750V

Enterable range: > 40 V ... < 999 V

#### Limit Values for Constant Test Voltage

Limits U<sub>INS</sub> (U<sub>INS</sub>)

Limit Value: R: >1.0MΩ R: >0.1MΩ R: >0.3MΩ R: >0.5MΩ R: >1.0MΩ R: >2.0MΩ R: >10.0MΩ Eff: >100MΩ

R<sub>INS</sub> < Limit Value

U<sub>L</sub> | R<sub>L</sub>

#### Test Voltage

A test voltage which deviates from nominal voltage, and is usually lower, can be selected for measurements at sensitive components, as well as systems with voltage limiting devices.

#### Voltage Type

The "U<sub>INS</sub>" rising test voltage function (ramp function) is used to detect weak points in the insulation, as well as to determine response voltage for voltage limiting components. After pressing the ON/START key, test voltage is continuously increased until the specified nominal voltage U<sub>N</sub> is reached. U is the voltage which is measured at the test probes during and after testing. After measurement, this voltage drops to a value of less than 10 V (see section entitled "Discharging the Device Under Test").

Insulation measurement with rising test voltage is ended:

- As soon as specified maximum test voltage U<sub>N</sub> is reached and the measured value is stable

or

- As soon as specified maximum test voltage is reached (e.g. after sparkover occurs at breakdown voltage).

Specified maximum test voltage U<sub>N</sub> or any triggering or breakdown voltage which occurs is displayed for U<sub>INS</sub>.

The constant test voltage function offers two options:

- After **briefly** pressing the **ON/START** ▼ key, specified test voltage  $U_N$  is read out and insulation resistance  $R_{INS}$  is measured. As soon as the measured value is stable (settling time may be several seconds in the case of high cable capacitance values), measurement is ended and the last measured values for  $R_{INS}$  and  $U_{INS}$  are displayed. **U** is the voltage which is measured at the test probes during and after testing. After measurement, this voltage drops to a value of less than 10 V (see section entitled "Discharging the Device Under Test").

or

- As long as you** press and hold the **ON/START** ▼ key, test voltage  $U_N$  is applied and insulation resistance  $R_{INS}$  is measured. Do not release the key until the measured value has settled in (settling time may be several seconds in the case of high cable capacitance values). Voltage **U**, which is measured during testing, corresponds to voltage  $U_{INS}$ . After releasing the **ON/START** ▼ key, measurement is ended and the last measured values for  $R_{INS}$  and  $U_{INS}$  are displayed. **U** drops to a value of less than 10 V after measurement (see the section entitled "Discharging the Device Under Test").

#### □ Pole Selection Report Entry

The poles between which testing takes place can only be entered here for reporting purposes. The entry itself has no influence on the actual polarity of the test probes or the pole selection.

#### □ Limits – Setting the Limit Value

The limit value for insulation resistance can be set as desired. If measurement values occur which are below this limit value, the red  $U_L/R_L$  LED lights up. A selection of limit values ranging from 0.5 M $\Omega$  to 10 M $\Omega$  is available. The limit value is displayed above the measured value.

### Start Measurement – Rising Test Voltage (ramp function)

Press briefly:

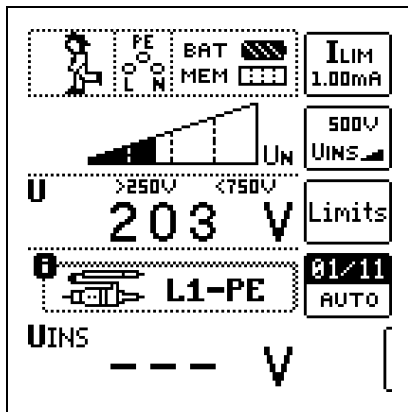

Quick polarity reversal if parameter is set to AUTO:

01/10 ... 10/10: L1-PE ... L1-L3



#### Note

If **semiautomatic polarity reversal** is selected (see section 10.9), the corresponding icon is displayed instead of the ramp.

### General Notes Regarding Insulation Measurements with Ramp Function

Insulation measurement with ramp function serves the following purposes:

- Detect weak points in the test object's insulation
- Determine tripping voltage of voltage limiting components and test them for correct functioning. These components may include, for example, varistors, overvoltage limiters (e.g. DEHNguard® from Dehn+Söhne) and spark gaps.

The test instrument uses continuously rising test voltage for this measuring function, up to the maximum selected voltage limit. The measuring procedure is started by pressing the **ON/START** ▼ key and runs automatically until one of the following events

occurs:

- The selected voltage limit is reached
  - The selected current limit is reached
- or
- Sparkover occurs (spark gaps)

Differentiation is made amongst the following three procedures for insulation measurement with ramp function:

### Testing overvoltage limiters or varistors and determining their tripping voltage:

- Select maximum voltage such that the anticipated breakdown voltage of the device under test is roughly one third of this value (observe manufacturer's data sheet if applicable).
- Select the current limit value in accordance with actual requirements or the manufacturer's data sheet (characteristic curve of the device under test).

### Determining tripping voltage for spark gaps:

- Select maximum voltage such that the anticipated breakdown voltage of the device under test is roughly one third of this value (observe manufacturer's data sheet if applicable).
- Select the current limit value in accordance with actual requirements within a range of 5 to 10  $\mu$ A (response characteristics are too unstable with larger current limit values, which may result in faulty measurement results).

### Detecting weak points in the insulation:

- Select maximum voltage such that it does not exceed the test object's permissible insulation voltage; it can be assumed that an insulation fault will occur even with a significantly lower voltage if an accordingly lower maximum voltage value is selected (nevertheless at least greater than anticipated breakdown voltage) – the ramp is less steep as a result (increased measuring accuracy).
- Select the current limit value in accordance with actual requirements within a range of 5 to 10  $\mu$ A (see also settings for spark gaps).

### Start Measurement – Constant Test Voltage

Press and hold for long-term measurement:

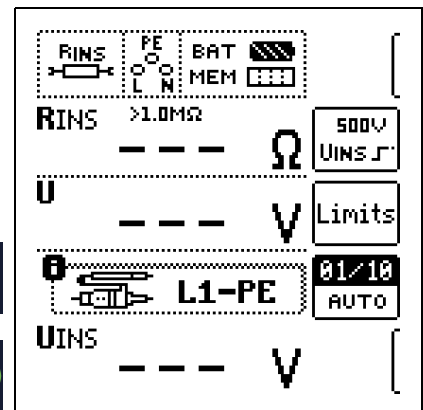

Quick polarity reversal if parameter is set to AUTO: 01/10 ... 10/10: L1-PE ... L1-L3



#### Note

The instrument's batteries are rapidly depleted during the insulation resistance measurement. When using the **constant test voltage** function, only press and hold the start key ▼ until the display has become stable (if long-term measurement is required).

## Special Condition for Insulation Resistance Measurement



### Attention!

Insulation resistance can only be measured at voltage-free objects.

If measured insulation resistance is less than the selected limit value, the **UL/RL** LED lights up.

If an interference voltage of  $\geq 25$  V is present within the system, insulation resistance is not measured. The **MAINS/NETZ** LED lights up and the **interference voltage** pop-up message appears.

All conductors (L1, L2, L3 and N) must be tested against PE!



### Attention!

Do not touch the instrument's terminal contacts during insulation resistance measurements!

If nothing has been connected to the terminal contacts, or if a resistive load component has been connected for measurement, your body would be exposed to a current of approximately 1 mA at a voltage of 1000 V. The resultant perceptible shock may lead to injury (e.g. resulting from a startled reaction etc.).

## Discharging the Device Under Test



### Attention!

If measurement is performed at a capacitive object such as a long cable, it becomes charged with up to approx. 1000 V! **Touching such objects is life endangering!**

When an insulation resistance measurement has been performed on a capacitive object it's automatically discharged by the instrument after measurement has been completed. Contact with the device under test must be maintained to this end. The falling voltage value can be observed at the U display.



### Attention!

**Do not disconnect the DUT until less than 10 V is displayed for U!**

## Evaluating Measured Values

Instrument measuring error must be taken into consideration in order to assure that the limit values set forth in DIN VDE regulations are not fallen short of. The required minimum display values for insulation resistance can be determined with the help of Table 3 on page 100. These values take maximum device error into consideration (under nominal conditions of use). Intermediate values can be interpolated.

## 16.2 Special Case: Earth Leakage Resistance ( $R_{EISO}$ )

This measurement is performed in order to determine electrostatic discharge capacity for floor coverings in accordance with EN 1081.

### Select Measuring Function

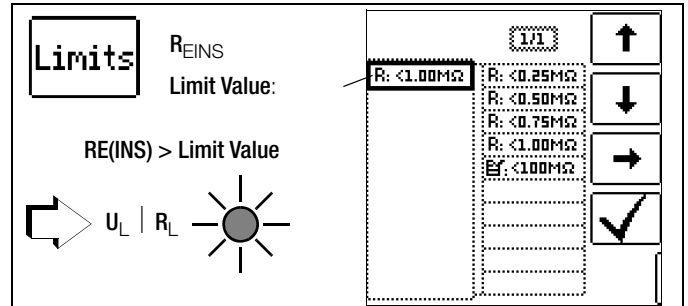

### Set Parameters

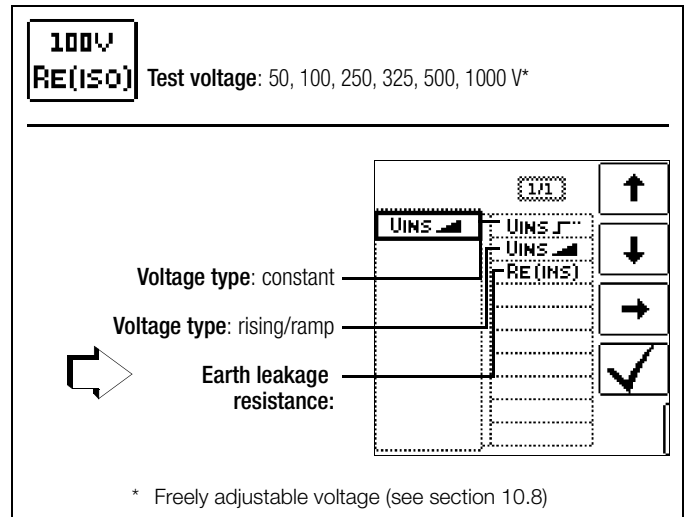

### Connection and Test Setup

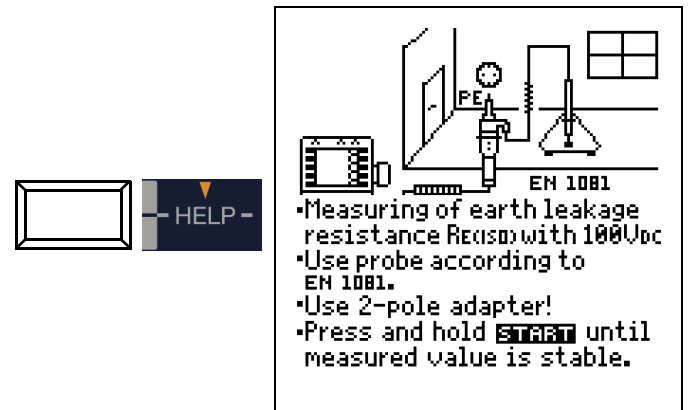

- Rub the floor covering at the point at which measurement is to be performed with a dry cloth.
- Place the 1081 floor probe onto the point of measurement and load it with a weight of at least 300 N (30 kg).
- Establish a conductive connection between the measuring electrode and the test probe and connect the measuring adapter (2-pole) to an earth contact, e.g. the earthing contact at a mains outlet or a central heating radiator (prerequisite: reliable ground connection).

## Start Measurement

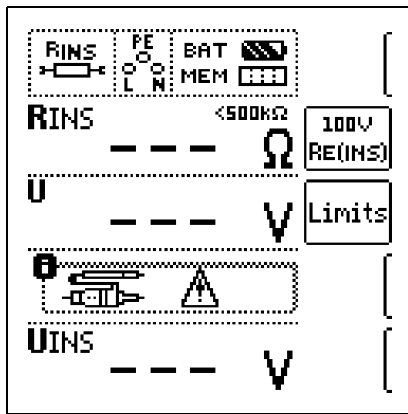

The limit value for earth leakage resistance from the relevant regulations applies.

# 17 Measuring Low-Value Resistance of up to 200 Ω (Protective Conductor and Equipotential Bonding Conductor)

According to the regulations, the measurement of low-value resistance at protective conductors, earth conductors or bonding conductors must be performed with (automatic) polarity reversal of the test voltage, or with current flow in one (+ pole to PE) and then the other direction (- pole to PE).



### Attention!

Low-resistance may only be measured at voltage-free objects.

### Select Measuring Function



### Connection

via 2-pole adapter only!

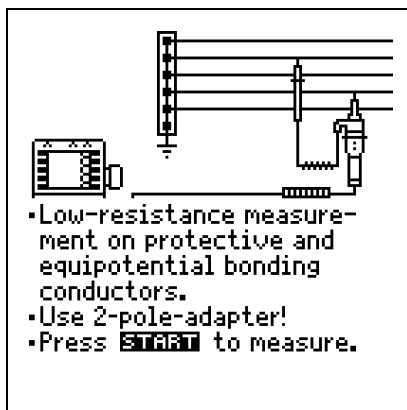

- Low-resistance measurement on protective and equipotential bonding conductors.
- Use 2-pole-adapter!
- Press **START** to measure.

### Set Parameters

**ROFFSET**  
ON OFF ROFFSET: ON ↔ OFF

**TYP**  
↔ PE

Polarity: +/- to PE

Polarity: +/- to PE with ramp sequence

**Limits**

Limit Value: RLo: <1.00Ω RLo: <0.10Ω RLo: <0.30Ω RLo: <1.00Ω Ef: <10.0Ω

$R_{LO} > \text{Limit Value}$

$U_L | R_L$

### ROFFSET ON/OFF

#### – Compensation for Measurement Cables up to 10 Ω

If measurement cables or extension cables are used, their resistance can be automatically subtracted from the measurement results. Proceed as follows:

- Switch **ROFFSET** from OFF to ON. **ROffset = 0.00 Ω** appears in the footer.
- Select a polarity option or automatic polarity reversal.
- Short-circuit the end of the measurement extension cable with the second test probe at the instrument.
- Start measurement of offset resistance with  $I_{\Delta N}$ .

First of all, an intermittent acoustic warning is generated and a blinking message appears, in order to prevent inadvertent deletion of a previously saved offset value.

- Start offset measurement by pressing the triggering key once again or abort offset measurement by pressing the **ON/START** key (in this case = **ESC**).



### Note

If offset measurement is stopped upon appearance of a pop-up error window indicating **ROffset > 10 Ω** or a **difference between RLO+ and RLO- of greater than 10%**, the last measured offset value is retained. Inadvertent deletion of a previously ascertained offset value is thus practically ruled out. The respectively smaller value is otherwise stored to memory as an offset value. The maximum offset value is 10.0 Ω. Negative resistances may result due to the offset value.

### Measuring RROFFSET

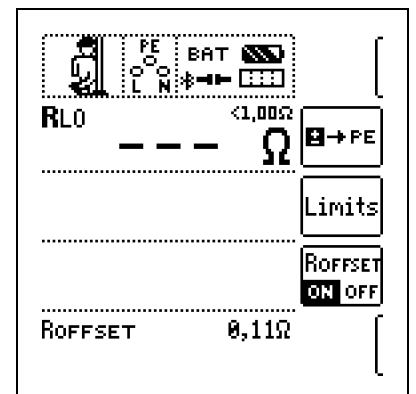

The **ROFFSET x.xx Ω** message now appears in the footer at the display, where x.xx can be a value between 0.00 and 10.0Ω. This value is subtracted from the actual measuring results for all subsequent  $R_{LO}$  measurements, if the **ROFFSET ON/OFF** key has been set to **ON**.

**ROFFSET** must be redetermined in the following cases:

- After switching to a different polarity option
- After switching from **ON** to **OFF** and back again

The offset value can be deliberately deleted by switching **ROFFSET** from **OFF** to **ON**.



### Note

Only use this function when performing measurements with extension cables. When different extension cables are used, the above described procedure must always be repeated.

### Type / Polarity

The direction in which current flows can be selected here.

### Limits – Setting the Limit Value

The limit value for resistance can be set as desired. If measured values occur which are above this limit value, the red **UL/RL** LED lights up. Limit values can be selected within a range of 0.10 Ω to 10.0 Ω (editable). The limit value is displayed above the measured value.

## 17.1 Measurement with Constant Test Current

### Start Measurement



Press and hold for long-term measurement

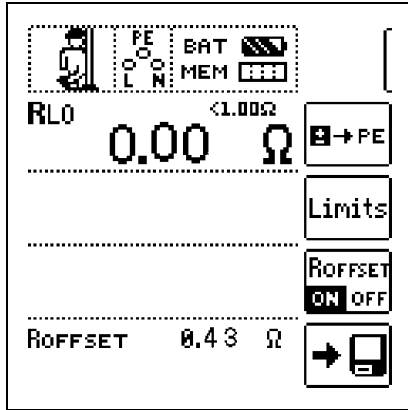

#### Attention!

The test probes should always be in contact with the device under test before the Start key ▼ is activated.  
 If the DUT is energized, measurement is disabled as soon as it's contacted with the test probes.  
 If the start key ▼ is pressed first and the DUT is contacted with the test probes afterwards, the fuse blows.  
 Which of the two fuses has blown is indicated in the pop-up window with the error message by means of an arrow.

In the case of single-pole measurement, the respective value is saved to the database as  $R_{LO}$ .

Polarity Selection	Display	Condition
+ pole to PE	RLO+	None
- pole to PE	RLO-	None
± Pole to PE	RLO	Where $\Delta RLO \leq 10\%$
	RLO+ RLO-	Where $\Delta RLO > 10\%$

### Automatic Polarity Reversal

After the measuring sequence has been started, the instrument performs the measurement with automatic polarity reversal, first with current flow in one direction, and then in the other. In the case of long-term measurement (press and hold ON/START ▼ key), polarity is switched once per second.

If the difference between RLO+ and RLO- is greater than 10% with automatic polarity reversal, RLO+ and RLO- values are displayed instead of RLO. The respectively larger value, RLO+ or RLO-, appears at the top and is saved to the database as the RLO value.

### Evaluating Measurement Results

Differing results for measurements in both directions indicate voltage at the DUT (e.g. thermovoltages or unit voltages).

Measurement results can be distorted by parallel connected impedances in load current circuits and by equalizing current, especially in systems which make use of overcurrent protection devices (previous neutralization) without an isolated protective conductor. Resistances which change during measurement (e.g. inductance), or a defective contact, can also cause distorted measurements (double display).

In order to assure unambiguous measurement results, causes of error must be located and eliminated.

In order to find the cause of the measuring error, measure resistance in both current flow directions.

The instrument's batteries are exposed to excessive stress during insulation resistance measurement. For measurement with current flow in one direction, only press and hold the ON/START ▼ key as long as necessary for the measurement.



#### Note

Measuring Low-Value Resistance  
 Measurement cable and 2-pole measuring adapter resistance is compensated automatically thanks to the 4-wire method and thus doesn't affect measurement results. However, if an extension cord is used its resistance must be measured and deducted from the measurement results.

Resistances which do not demonstrate a stable value until after a "settling in period" should not be measured with automatic polarity reversal, but rather one after the other with positive and negative polarity.

Examples of resistances whose values may change during measurement include:

- Incandescent lamp resistance, whose values change due to warming caused by test current
- Resistances with a large conductive component
- Contact resistance

### Evaluating Measured Values

See Table 4 on page 100.

### Calculation of Cable Lengths for Common Copper Conductors

If the HELP key is activated after performance of resistance measurement, the cable lengths corresponding to common conductor cross sections are displayed.



RLO: 0.16 Ω			
Ø	l	Ø	l
[mm²]	[m]	[mm²]	[m]
0.14:	1	2.5:	20
0.25:	2	4.0:	32
0.50:	4	6.0:	48
0.75:	6	10.0:	80
1.00:	8	16.0:	127
1.50:	12	25.0:	199

If results vary for the two different current flow directions, cable length is not displayed. In this case, capacitive or inductive components are apparently present which would distort the calculation.

This table only applies to cables made with commercially available copper conductors and cannot be used for other materials (e.g. aluminum).

## 17.2 Protective Conductor Resistance Measurement with Ramp Sequence – Measurement at PRCDs with Current-Monitored Protective Conductor using the PROFITEST PRCD Test Adapter as an Accessory ( PROFITEST MXTRA only)

### Application

Protective conductor current is monitored for certain types of PRCDs. Direct activation or deactivation of the test current required for protective conductor resistance measurements of at least 200 mA results in tripping of the PRCD and thus to interruption of the protective conductor connection. Protective conductor measurement is no longer possible in this case.



A special ramp sequence for test current activation and deactivation in combination with the PROFITEST PRCD test adapter permits protective conductor resistance measurement without tripping the PRCD.

### Ramp Function Time Sequence

Due to the physical characteristics of the PRCD, measuring times for this ramp function amount to several seconds.

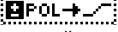
If test current polarity is reversed, additional waiting time is also required during polarity reversal.

This is programmed into the test sequence in the “automatic polarity reversal”  operating mode.

Reverse polarity manually, e.g. from “+pole with ramp”  to “-pole with ramp” . The test instrument then detects the reversal of current flow direction, stops measurement for the required waiting time and simultaneously displays a corresponding message (see figure at right).

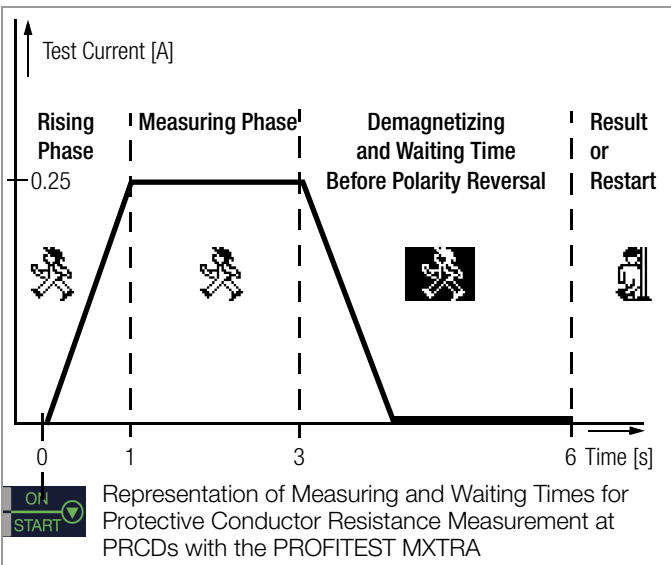
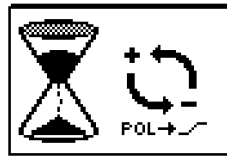

### PRCD Tripping due to Poor Contacting

Good contact must be assured between the test probes at the 2-pole adapter and the device under test or the sockets at the PROFITEST PRCD test adapter during measurement. Interruptions can result in considerable test current fluctuation which causes the PRCD to trip under unfavorable conditions.

If this is the case, tripping of the PRCD is automatically detected by the test instrument and indicated by a corresponding error message (see figure at the right). In this case as well, the test instrument automatically takes subsequently required waiting time into account before you can reactivate the PRCD and start the measurement over again.

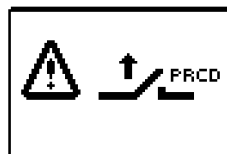

### Connection

- Read the operating instructions for the PROFITEST PRCD adapter, in particular section 4.1. It includes connection instructions for offset measurement and for protective conductor resistance measurement.

### Selecting the Polarity Parameter

- Select the desired polarity parameter with ramp.

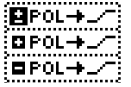

### Measuring ROFFSET



- Perform offset measurement as described on page 77, in order to assure that the test adapter’s connector contacts are not included in the measurement results.



### Note

The offset is only retained in memory until the polarity parameter is changed. If measurement is performed with manual polarity reversal (+pole or -pole), the offset measurement has to be repeated in both polarities before each measurement.

### Measuring Protective Conductor Resistance

- Determine whether or not the PRCD is activated. If not, activate it.
- Perform protective conductor measurement as described in section 17.1 above. Start the test sequence by briefly pressing the ON/START  key. The predetermined duration of the measuring phase can be extended by pressing and holding the ON/START  key.

### Start Measurement

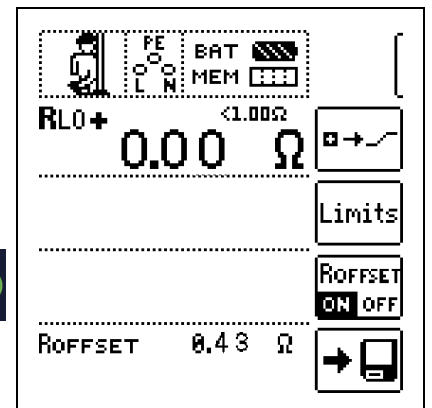
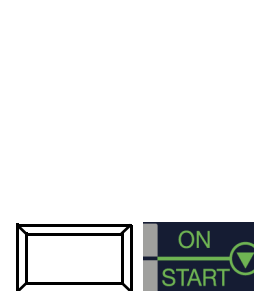

The symbol shown at the right appears during the magnetization phase (rising curve) and the subsequent measuring phase (constant current).



If measurement is aborted already during the rising phase, no measurement results can be ascertained or displayed.

After measurement, the demagnetization phase (falling curve) and subsequent waiting time are indicated by the inverted symbol shown at the right.



No new measurements can be started during this time.

Measurement results cannot be read and measurement with the same or another polarity cannot be started until the symbol at the right appears.



## 18 Measurement with Accessory Sensors

### 18.1 Current Measurement with Current Clamp Sensor

Bias, leakage and circulating current up to 1 A, as well as leakage current up to 1000 A can be measured with the help of special current clamp sensors, which are connected to sockets 15 and 16.



#### Attention!

##### Danger: High-Voltage!

Use only current clamp sensors which are specifically offered as accessories by Gossen Metrawatt GmbH. Other current clamp sensors might not be terminated with an output load at the secondary side. Dangerously high voltage may endanger the user and the device in such cases.



#### Attention!

##### Maximum input voltage at the test instrument!

Do not measure any currents which are greater than specified for the measuring range of the respective clamp. Input voltage for clamp connector sockets 15 and 16 at the test instrument may not exceed 1 V!



#### Attention!

Be sure to read and adhere to the operating instructions for current clamp sensors and the safety precautions included therein, especially those regarding the approved measuring category.

### Select Measuring Function

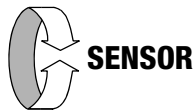

### Select Measuring Range at the Current Clamp Sensor

Test Instrument	Clamp Meters				Test Instrument
	WZ12C Switch	Z3512A Switch	WZ12C Measuring Range	Z3512A Measuring Range	
1:1 1 V / A	1 mV / mA	x 1000 [mV/A]	1 mA ... 15 A	0 ... 1 A	5 ... 999 mA
01:10 100 mV / A	—	x 100 [mV/A]	—	0 ... 10 A	0.05 ... 10 A
1:100 10 mV / A	—	x 10 [mV/A]	—	0 ... 100 A	0.5 ... 100 A
1:1000 1 mV / A	1 mV / A	x 1 [mV/A]	1 A ... 150 A	0 ... 1000 A	5 ... 150A/999A

Test Instrument	Clamp		Test Instrument
	METRAFLEX P300 Switch	METRAFLEX P300 Measuring Range	
1:1 1 V / A	3 A (1 V/A)	3 A	5 ... 999 mA
01:10 100 mV / A	30 A (100 mV/A)	30 A	0.05 ... 10 A
1:100 10 mV / A	300 A (10 mV/A)	300 A	0.5 ... 100 A

### Set Parameters

The transformation ratio parameter must be correspondingly set at the test instrument depending upon the respectively selected measuring range at the current clamp sensor.

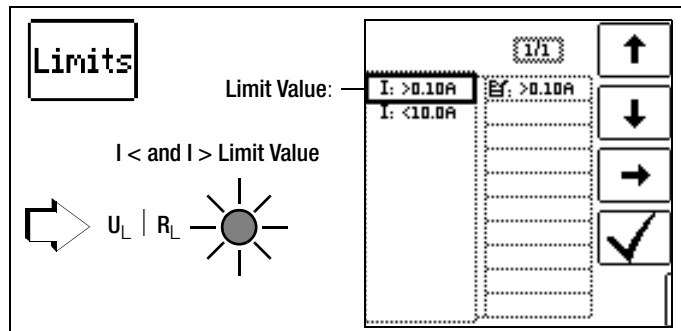
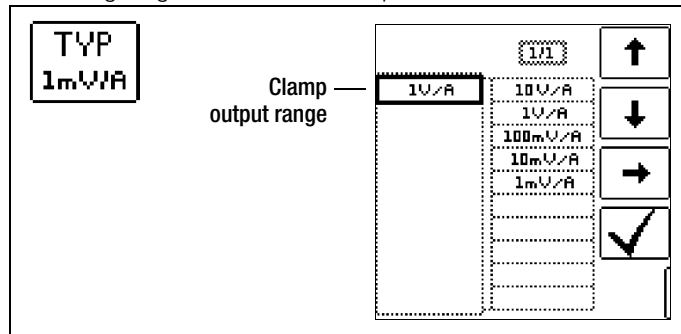

Specifying limit values results in automatic evaluation at the end of the measurement.

### Connection

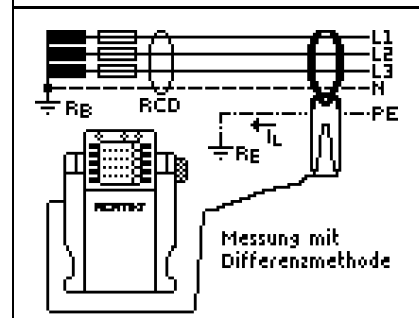
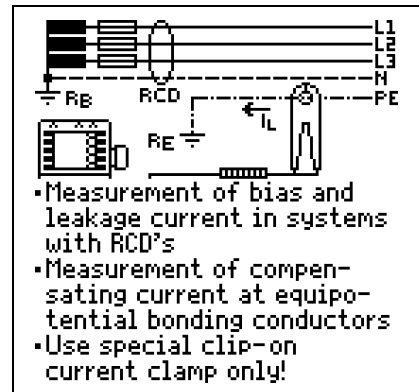

### Start Measurement



Press the OK key to stop the measurement.

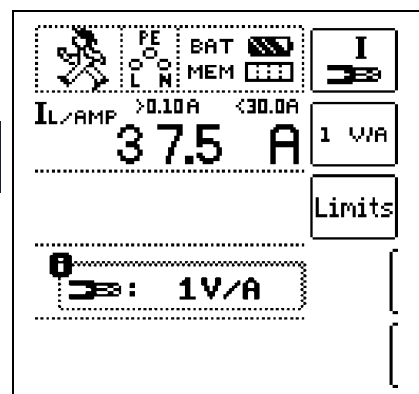



## 19 Special Functions – EXTRA Switch Position

Select the EXTRA Switch Position



Overview of Special Functions

Softkey	Meaning / Special Function	PROFITEST MBASE+	PROFITEST MTECH+	PROFITEST MPRO	PROFITEST MXTRA	Section / Page
	Voltage drop measurement $\Delta U$ function	✓	✓	✓	✓	section 19.1 on page 82
	Standing surface insulation impedance $Z_{ST}$ function	✓	✓	✓	✓	section 19.2 on page 83
	Meter startup test kWh function	✓	✓	✓	✓	section 19.3 on page 84
	Leakage current measurement $I_L$ function	–	–	–	✓	section 19.4 on page 85
	Insulation monitor test IMD function	–	–	–	✓	section 19.5 on page 86
	Residual voltage test Ures function	–	–	–	✓	section 19.6 on page 88
	Intelligent ramp $t_a + I\Delta$ function	–	–	–	✓	section 19.7 on page 89
	RCM residual current monitor RCM function	–	–	–	✓	section 19.8 on page 90
	Testing of electric vehicle operating statuses at charging stations per IEC 61851-1	–	✓	–	✓	section 19.9 on page 91
	Documentation of fault simulations at PRCDs with the PROFITEST PRCD adapter	–	–	–	✓	section 19.10 on page 92

### Selecting Special Functions

The list of special functions is accessed by pressing the uppermost softkey. Select the desired function with the appropriate icon.

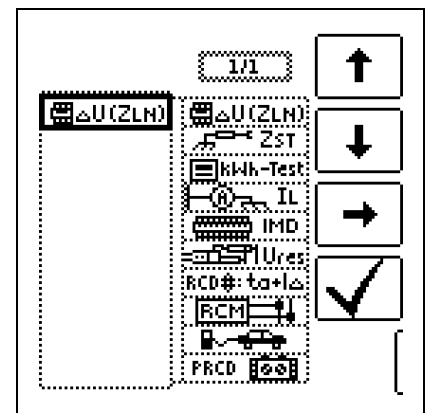
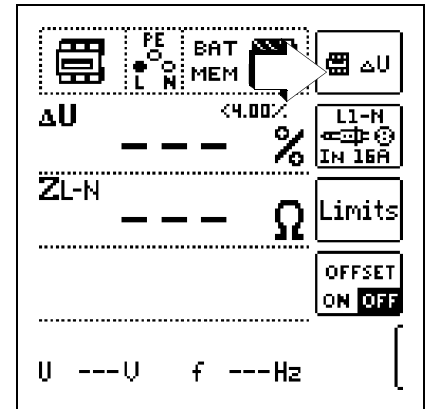

## 19.1 Voltage Drop Measurement (at $Z_{L-N}$ ) – $\Delta U$ Function

### Significance and Display of $\Delta U$ (per IEC 60364-6)

Voltage drop from the intersection of the distribution network and the consumer system to the point of connection of an electrical power consumer (electrical outlet or device connector terminals) should not exceed 4% of nominal line voltage.

Calculating voltage drop (without offset):

$$\Delta U = Z_{L-N} \times \text{nominal current of the fuse}$$

Calculating voltage drop (with offset):

$$\Delta U = (Z_{L-N} - Z_{\text{OFFSET}}) \times \text{nominal current of the fuse}$$

$$\Delta U \text{ in } \% = 100 \times \Delta U / U_{L-N}$$

See also section 14 regarding the measurement procedure and connection.

### Connection and Test Setup

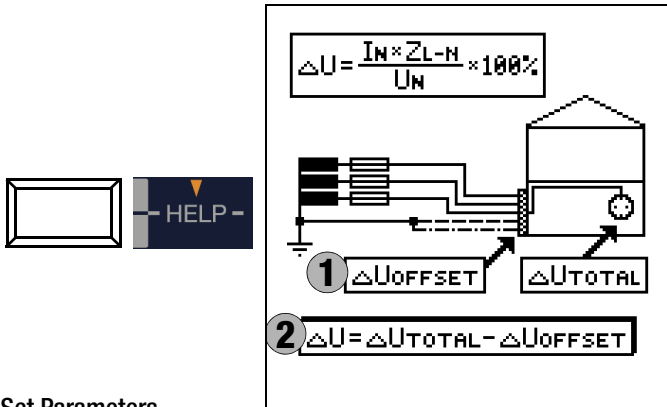

### Set Parameters

L1-N	L1-N
L2-N	L2-N
L3-N	L3-N
L1-L2	L1-L2
L2-L3	L2-L3
L1-L3	L1-L3
L-N	L-N



#### Note

If nominal current  $I_N$  is changed by  $\Delta U_{\text{OFFSET}}$ , the offset value is automatically adjusted.

### Set Limit Values

VDE	<4.00%
TAB	<0.50%
TAB	<1.00%
TAB	<1.25%
TAB	<1.50%
DIN	<3.00%
VDE	<4.00%
NL	<5.00%
NL	<10.0%

TAB Limit value per German technical connection conditions for connection to low-voltage mains between the distribution network and the measuring device

DIN Limit value per DIN 18015-1:  $\Delta U < 3\%$  between the measuring device and the consuming device

VDE Limit value per DIN VDE 0100-520:  $\Delta U < 4\%$  between the distribution network and the consuming device (adjustable up to 10% in this case)

NL Limit value per NIV:  $\Delta U < 5\%$

### Measurement Without OFFSET

Proceed as follows:

- Switch **OFFSET** from **ON** to **OFF**.



### Determine OFFSET (in %).

Proceed as follows:

- Switch **OFFSET** from **OFF** to **ON**.  $\Delta U_{\text{OFFSET}} = 0.00\%$  is displayed.
- Connect the test probe to the point of common coupling (measuring device / meter).
- Start measurement of offset with  $I_{\Delta N}$ .

First of all, an intermittent acoustic warning is generated and a blinking message appears, in order to prevent inadvertent deletion of a previously saved offset value.

- Start offset measurement by pressing the triggering key once again, or abort offset measurement by pressing the **ON/START** key (in this case **ESC**).



$\Delta U_{\text{OFFSET}} \times x.xx\%$  is displayed and  $x.xx$  can be a value within a range of 0.00 to 99.9%.

An error message appears in a pop-up window if  $Z$  exceeds 9.99  $\Omega$ .

### Start measurement with OFFSET.



## 19.2 Measuring the Impedance of Insulating Floors and Walls (standing surface insulation impedance) – $Z_{ST}$ Function

### Measuring Method

The instrument measures the impedance between a weighted metal plate and earth. Line voltage available at the measuring site is used as an alternating voltage source. The  $Z_{ST}$  equivalent circuit is considered a parallel circuit.

### Connection and Test Setup

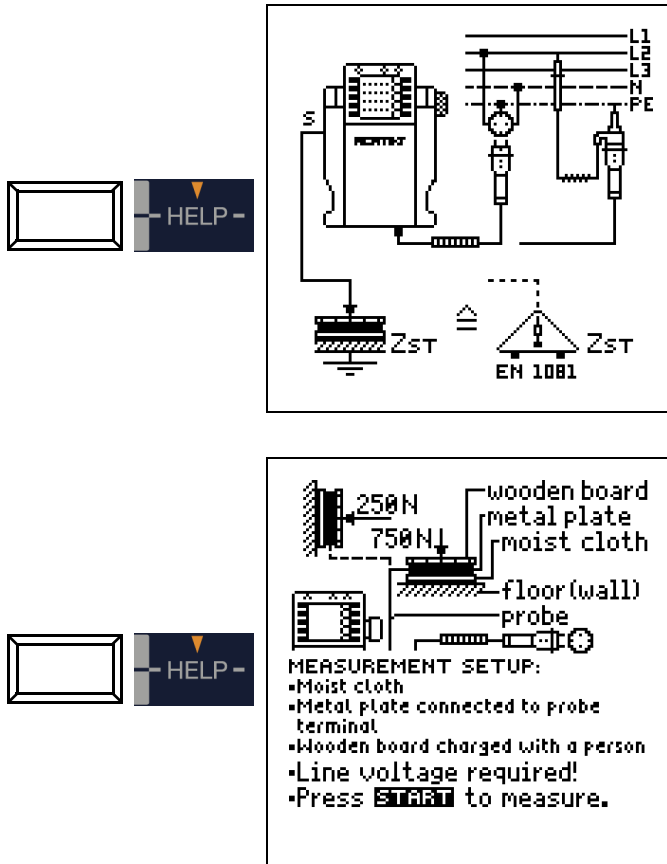

#### Note

Use the measuring setup described in section 16.2 (triangular probe) or the one outlined below:

- Cover the floor or the wall at unfavorable locations, e.g. at joints or abutments, with a damp cloth measuring approx. 270 × 270 mm.
- Place the 1081 Probe on top of the damp cloth and load the probe with a weight of 750 N (75 kg, i.e. one person) for floors, or 250 N (25 kg) for walls, e.g. press against the wall with one hand which is insulated with a glove).
- Establish a conductive connection to the 1081 Probe, and connect it to the probe connector socket at the instrument.
- Connect the instrument to a mains outlet with the test plug.



#### Attention!

Do **not** touch the metal plate or the damp cloth with your bare hands.  
No more than 50% line voltage may be applied to these parts! Current with a value of up to 3.5 mA may flow!  
The measured value would be distorted as well.

### Start Measurement

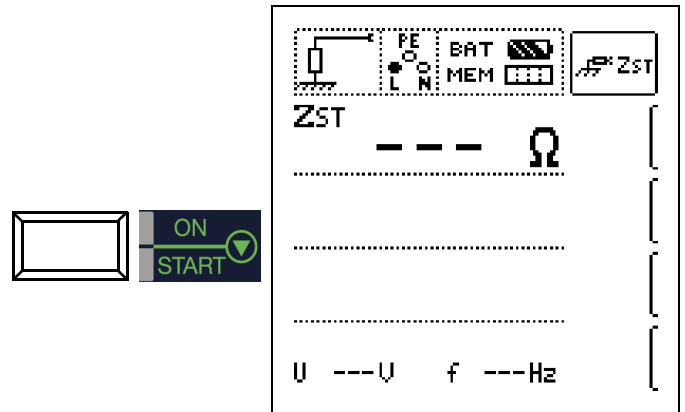

### Evaluate Measured Value

The measured value has to be evaluated after measurement has been completed:

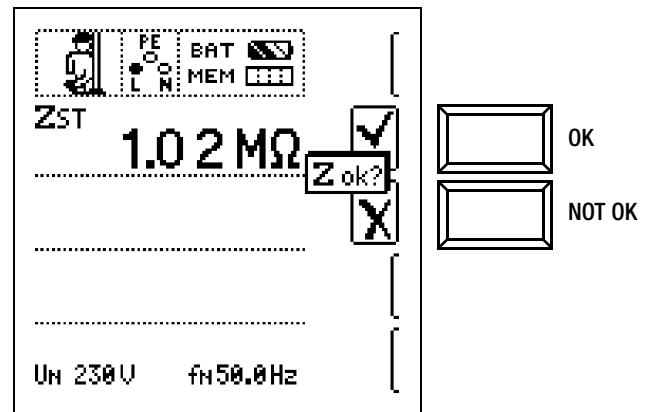

Resistance values must be measured at several points in order to provide for adequate evaluation. Measured resistance may not be less than 50 kΩ at any given point. If the measured value is greater than 30 MΩ,  $Z_{ST} > 30.0$  MΩ always appears at the display panel.

In the event that “NOT OK” is selected, an error is indicated by the **UL/RL** LED which lights up red.

See also Table 5 on page 101 with regard to evaluating measured values.

The measured value cannot be saved to memory and included in the test report until it has been evaluated.

### Save measured value

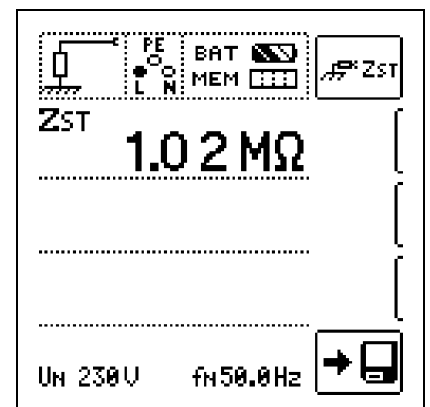

### 19.3 Testing Meter Startup with Earthing Contact Plug – kWh Function

Energy consumption meters can be tested for correct startup with this function.

#### Connection L – N

##### Earthing Contact Plug

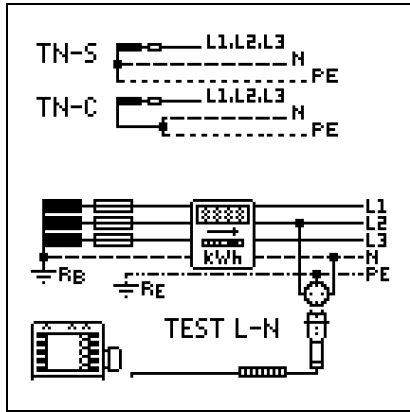

#### Start Measurement

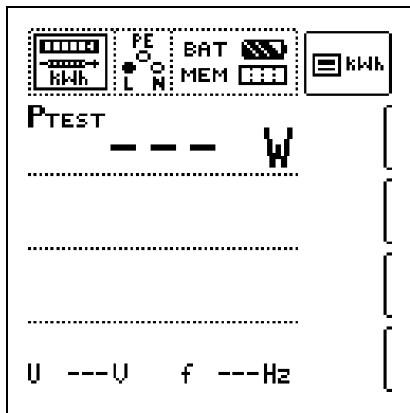

The meter is tested with the help of an internal load resistor and a test current of approximately 250 mA. After pressing the **Start** key, test power is displayed and the meter can be tested for proper startup within a period of 5 seconds. The “RUN” pictograph is displayed.

TN systems: All 3 phase conductors must be tested against N, one after the other.

In other types of systems, all phase conductors (active conductors) must be tested against one another.

#### Note

If minimum power is not reached, the test is either not started or aborted.

#### Evaluate Measured Value

The measured value has to be evaluated after measurement has been completed:

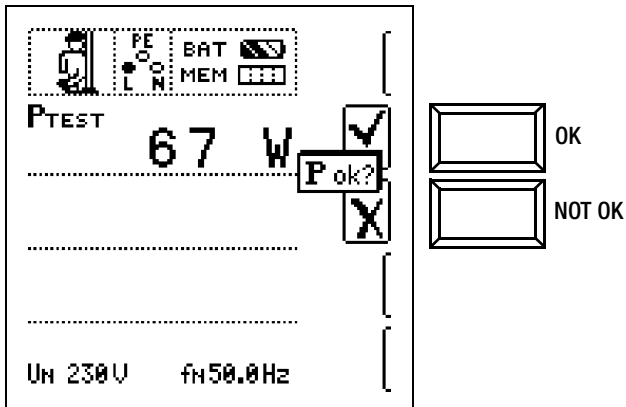

In the event that “NOT OK” is selected, an error is indicated by the UL/RL LED which lights up red.

The measured value cannot be saved to memory and included in the test report until it has been evaluated.

#### Save measured value

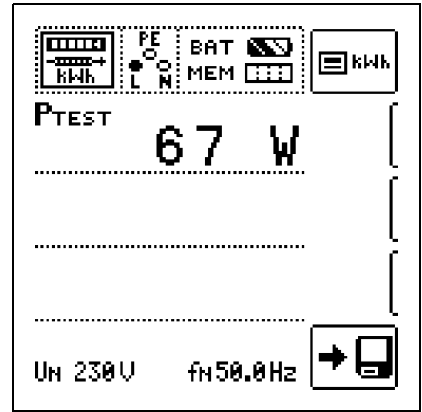

#### Special Case

Startup of energy consumption meters which are connected between L and L or L and N can be tested with this function.

#### Connection L – L

##### 2-Pole Adapter

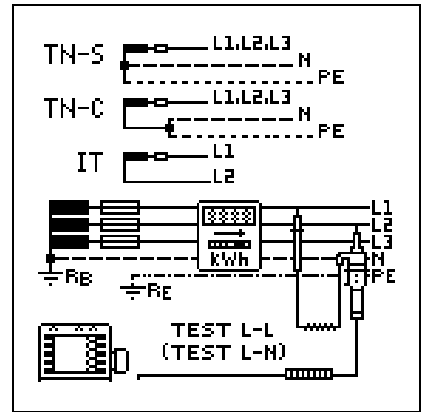

#### Note

If an earthing contact outlet is not available, you can use the 2-pole adapter. N must be contacted with the PE test probe (L2), and then measurement must be started.

If PE is contacted with the PE test probe (L2) during the meter startup test, approximately 250 mA flow through the protective conductor and any upstream RCD is tripped.

## 19.4 Leakage Current Measurement with PRO-AB Leakage Current Adapter as Accessory – I<sub>L</sub> Function (PROFITEST MXTRA only)

### Application

Measurement of touch voltage in accordance with DIN VDE 0107, part 10, as well as continuous leakage and patient auxiliary current per IEC 62353 (VDE 0750-1) / IEC 601-1 / EN 60601-1, is possible using the PRO-AB leakage current measuring adapter as an accessory with the test instrument.

As specified in the standards listed above, current values of up to 10 mA can be measured with this measuring adapter. In order to be able to fully cover this measuring range using the measurement input provided on the test instrument (2-pole current clamp input), the measuring instrument is equipped with range switching including transformation ratios of 10:1 and 1:1. In the 10:1 range, voltage dividing takes place at the same ratio.

### Connection and Test Setup

In order to perform the leakage current measurement, the adapter's measurement outputs must be plugged into the measurement inputs at the left-hand side of the test instrument (2-pole current clamp input and probe input).

Either of the leakage current measuring adapter's inputs is connected to reference earth (e.g. safe earth electrode / equipotential bonding) via a measurement cable. The metallic housing (accessible part) of the device under test is contacted with a test probe or alligator clip which is connected to the other input by means of a second measurement cable.

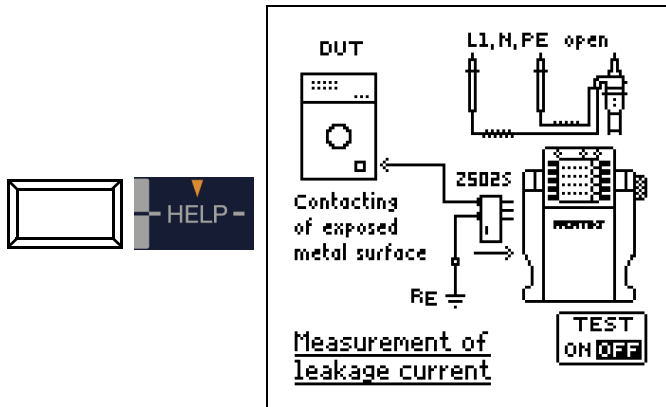

### Testing the PRO-AB Adapter

The adapter should be tested before use and at regular intervals (see adapter operating instructions).

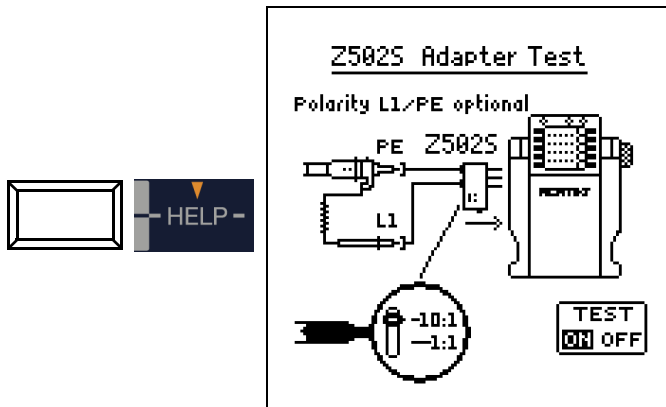

### Measuring Procedure

Refer to the operating instructions for the PRO-AB leakage current measuring adapter regarding performance of the measurement.

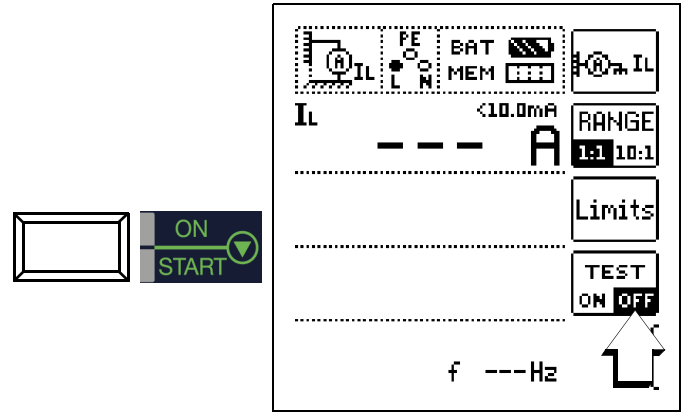

### Attention!

The test plug should be located in the storage slot during leakage current measurement. Under no circumstances may the test plug be connected with any system components, including PE / ground potential (measured values might otherwise be distorted).

The measurement can be started or stopped by pressing the **ON/START** key. Leakage current measurement is a long-term measurement, i.e. is continues until it's stopped by the user. The momentary measured value is displayed continuously during measurement.

### Note

The self-test must be deactivated in the menu (set **"TEST ON/OFF" function key to "OFF"**) in order to perform a measurement.

Always start with the large measuring range (10:1), unless there's no doubt that small measured values can be expected, in which case the small measuring range can be used (1:1). The measuring range must be selected at the measuring adapter, as well as in the menu using the corresponding function key (**RANGE**). It must be assured that the range settings at the adapter and at the test instrument are always identical, in order to prevent any distortion of measurement results.

Depending on the magnitude of the measured values, the range setting can or must (in the case of overranging) be manually corrected at the measuring adapter and the test instrument.

Individual limit values can be adjusted after pressing the **Limits** function key. Exceeded limit values are indicated by the red limit value LED at the test instrument.

## 19.5 Testing Insulation Monitoring Devices – IMD Function (PROFITEST MXTRA only)

### Application

Insulation monitoring devices (IMDs) or earth fault detection systems (EDS) are used in IT systems in order to monitor adherence to a minimum insulation resistance value as specified by DIN VDE 0100-410.

They're used in power supplies for which a single-pole earth fault may not result in failure of the power supply, for example in operating rooms or photovoltaic systems.

Insulation monitors can be tested with the help of this special function. After pressing the **ON/START** ▼ key, an adjustable insulation resistance is activated between one of the two phases of the IT system to be monitored and ground to this end. This resistance can be changed in the **MAN±** manual sequence mode with the help of the + or – softkey, or varied automatically from  $R_{max}$  to  $R_{min}$  in the **AUTO** operating mode. Testing is ended by once again pressing the **ON/START** ▼ key.

Time during which the momentary resistance value prevails since changing the value at the system is displayed. The IMD's display and response characteristics can be subsequently evaluated and documented with the help of the **OK** or **NOT OK** softkey.

### Connection L – N

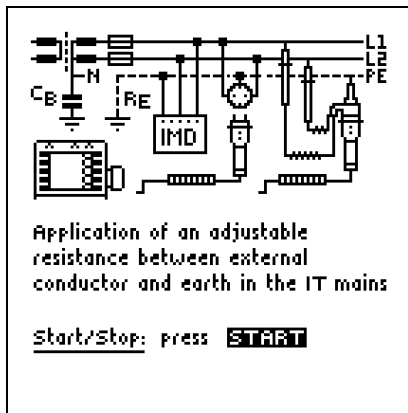

When selecting test resistance, don't forget that an excessively high test current could damage sensitive system components.

### Set Parameters

#### Measuring Procedure (1)

There are two ways to conduct the test:

- **MAN:** Resistance is changed manually by tapping the respective softkeys.
- **AUTO:** Resistance is changed automatically every 2 seconds beginning with **RSTART**.

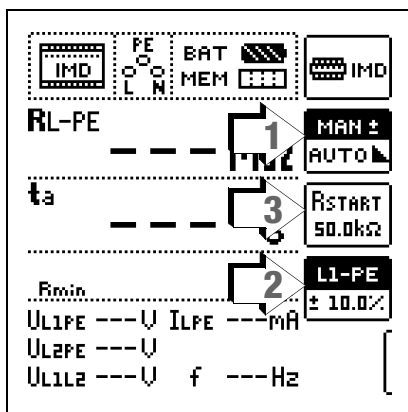

#### Resistance RSTART (3)

Numerous parameters are available for setting resistance **RSTART**, with which measurement is begun.

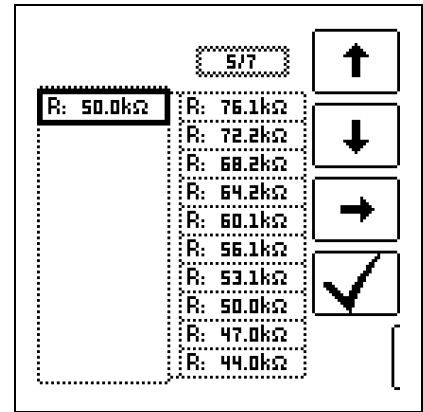

#### Conductor Relationship / Resistance Range (2)

- **Conductor relationship:** The corresponding conductor relationship can be selected for documentation of the measuring point.
- **Resistance range:** A range of values can be selected for testing the display of resistance at the IMD.

The parameter is set as a percentage with reference to the resistance momentarily introduced by the test instrument.

Upper and lower limit values are displayed in the measuring view.

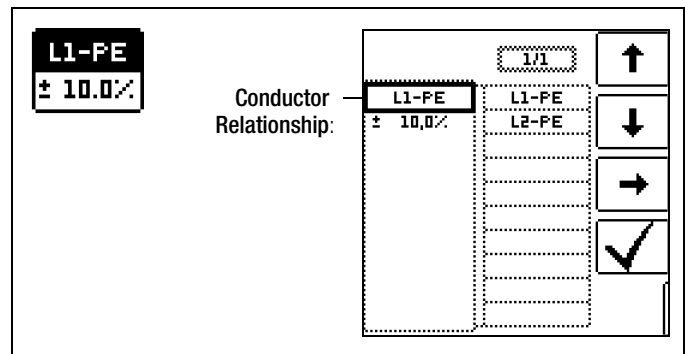

#### Measuring Procedure

- ◇ Set the parameters.
- ◇ Start: Press the **ON/START** ▼ key.
- ◇ A resistance is introduced between the phase and protective conductors and time measurement is started.
- ◇ **Manual test MAN + -:** press the ◀ or ▶ key to increase or reduce test resistance **RL-PE**.
- ◇ **Automatic test AUTO:** the resistance value is changed automatically.
- ◇ Time to trip  $t_a$  is restarted each time resistance is changed.
- ◇ Press  $I_{ΔN}$  in order to change the conductor relationship.
- ◇ In order to end measurement, press the **ON/START** ▼ key as soon as the IMD indicates that insulation resistance has been fallen short of.
- ◇ Display of measured values
- ◇ Evaluation query: Measurement **OK?**
- ◇ If evaluation is **NOT OK:** the **UL/RL** LED lights up red.
- ◇ Save: by pressing the soft key.

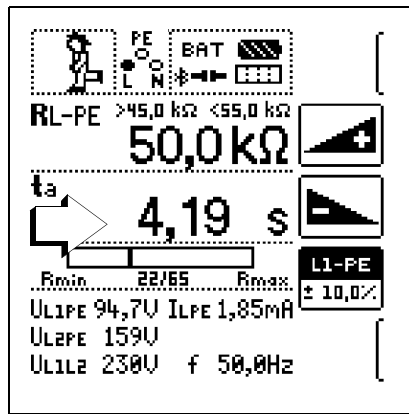

Measurement can be aborted by pressing the ON/START ▼ or ESC key.

### The following measured values are displayed:

- **RL-PE**: Active test resistance with upper and lower limit values
- **t<sub>a</sub>**: Response time (during which momentary resistance is applied until the measurement is ended)
- **R<sub>min</sub> - R<sub>max</sub>**: Status display indicating momentary resistance with reference to the number of possible resistances
- **U<sub>L1PE</sub>**: Momentary voltage at the test probes between phase conductor L1 and protective conductor PE
- **U<sub>L2PE</sub>**: Momentary voltage at the test probes between phase conductor L2 and protective conductor PE
- **U<sub>L1L2</sub>**: Momentary voltage at the test probes between phase conductors L1 and L2
- **I<sub>LPE</sub>**: Test current flowing through the active resistance
- **f**: Frequency of the applied voltage

### Evaluation

In order to evaluate the measurement, it must be stopped. This applies to manual as well as automatic measurement. Press the ON/START ▼ or ESC key to this end. The stopwatch is stopped and the evaluation window appears.

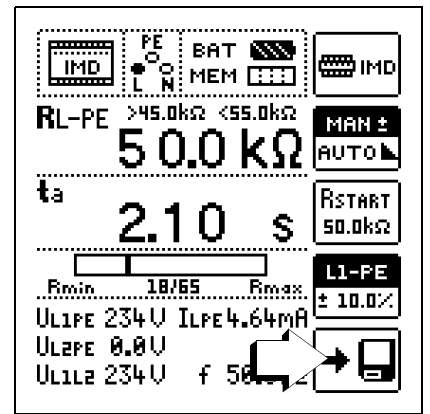
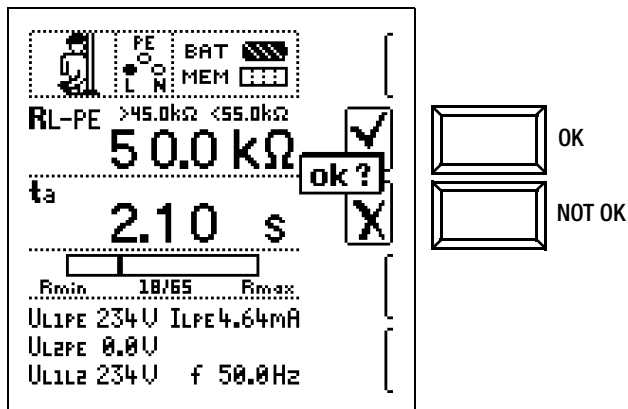

### Retrieving Saved Measured Values

The measured value cannot be saved to memory and included in the test report until it has been evaluated (see also section 9.4).

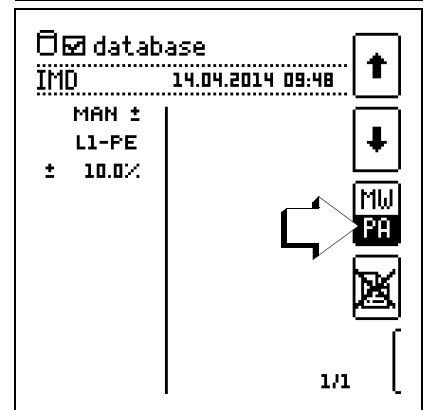
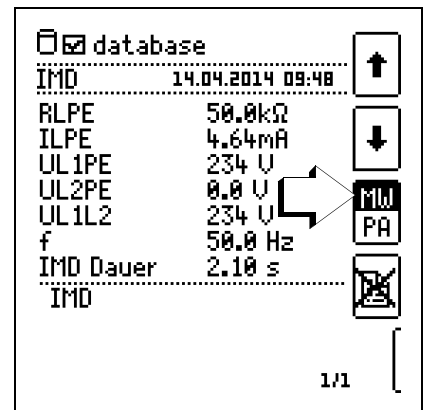

With the help of the key shown at the right (MW: measured value / PA: parameter), the setting parameters can be displayed for this measurement.



## 19.6 Residual Voltage Test – $U_{res}$ Function (PROFITEST MXTRA only)

### Application

The EN 60204 standard specifies that after switching supply power off, residual voltage must drop to a value of 60 V or less within 5 seconds at all accessible, active components of a machine to which a voltage of greater than 60 V is applied during operation.

Testing for the absence of voltage is performed as follows with the test instrument by means of a voltage measurement which involves the measurement of discharge time:

In the case of voltage dips of greater than 5% of momentary line voltage (within 0.7 seconds), the stopwatch is started and momentary undervoltage is displayed as  $U_{res}$  after 5 seconds and indicated by the red UL/RL LED.

The function is ended after 30 seconds after which  $U_{res}$  and  $t_u$  data can be deleted and the function can thus be restarted by pressing the ESC key.

### Connection

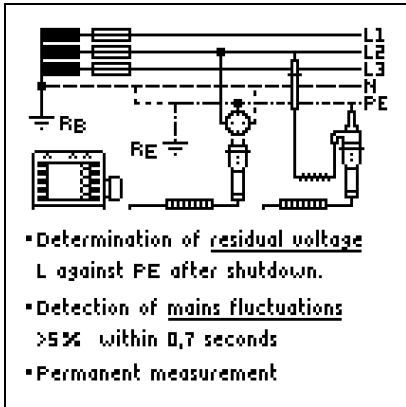

### Limit Values

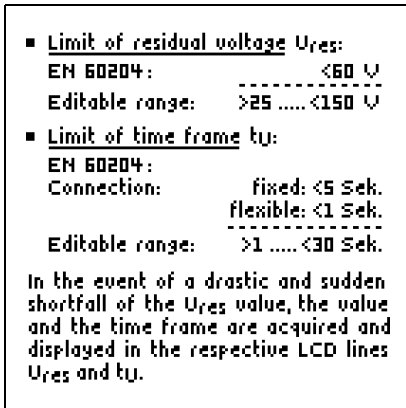

### Set Limit Values

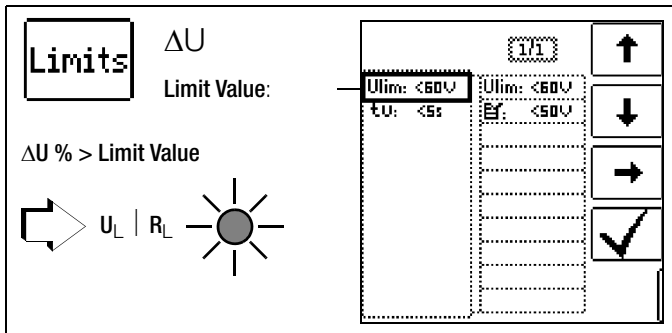

## Measuring Sequence – Long-Term Measurement

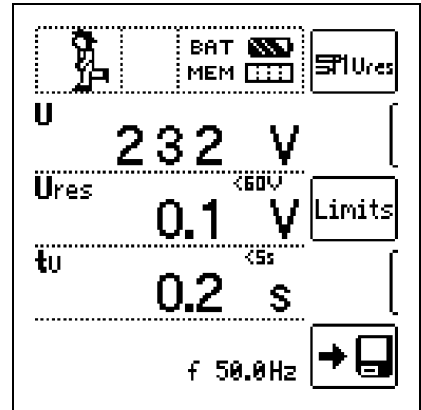

Testing is selected as a continuous measurement because residual voltage testing is triggered automatically and voltage measurement is always active for safety reasons.

### Note

If, for example, conductors are exposed when a machine is switched off – e.g. if plug connectors are disengaged – which are not protected against direct contact, maximum permissible discharge time is 1 second!



## 19.7 Intelligent Ramp – $t_a+I_{\Delta}$ Function (PROFITEST MXTRA only)

### Application

The advantage of this measuring function in contrast to individual measurement of  $I_{\Delta N}$  and  $t_A$  is the simultaneous measurement of breaking time and breaking current by means of a test current which is increased in steps, during which the RCD is tripped only once.

The intelligent ramp is subdivided into time segments of 300 ms each between the initial current value (35%  $I_{\Delta N}$ ) and the final current value (130%  $I_{\Delta N}$ ). This results in a gradation for which each step corresponds to a constant test current which is applied for no longer than 300 ms, assuming that tripping does not occur.

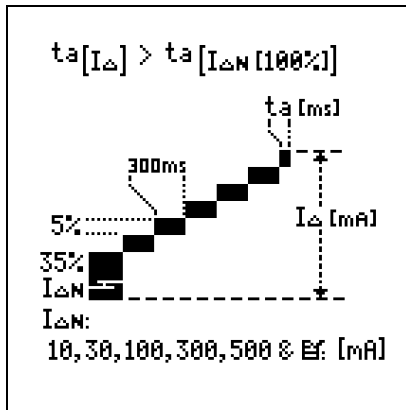

And thus both tripping current and tripping time are measured and displayed. Measured quantities are acquired with reduced accuracy.

### Connection

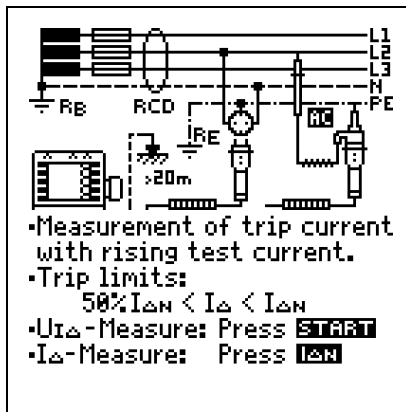

### Set Parameters

**30mA RCD TYP A**

Nom. res. current: 10 ... 500 mA **Ef**

Type 1: RCD, SRCD, PRCD ...

Type 2: AC , A/F , B

Nominal current: 6 ... 125 A

\* Type B = AC/DC sensitive

**$I_{\Delta N}$**

$I_{\Delta N}$ : 10mA
$I_{\Delta N}$ : 30mA
$I_{\Delta N}$ : 100mA
$I_{\Delta N}$ : 300mA
$I_{\Delta N}$ : 500mA

**RCD**

A

In: 25A

TN/TT

**Limits**

Touch voltage:  
< 25 V, < 50 V, < 65 V

**UL**

UL: <50V
UL: <25V
UL: <50V
UL: <65V

**$t_a$**

$t_a$ : <300ms
$t_a$ : >0ms

**$I_{\Delta}$**

$I_{\Delta}$ : >15.0mA
$I_{\Delta}$ : <30.0mA

### Start Touch Voltage Measurement



**UI $\Delta$ N** <50V

**30mA RCD TYP A**

**$t_a$**  >0ms <300ms

**Limits**

**$I_{\Delta}$**  >15.0mA <30.0mA

**RE** < 3  $\Omega$

**UN** 230V **fN** 50.0Hz

### Start Tripping Test



**UI $\Delta$ N** <50V

**30mA RCD TYP A**

**$t_a$**  >0ms <300ms

**Limits**

**$I_{\Delta}$**  >15.0mA <30.0mA

**RE** < 3  $\Omega$

**UN** 230V **fN** 50.0Hz

The measurement sequence can be broke off prematurely at any time by pressing the **ON/START**  $\blacktriangledown$  key.

### Measurement Results

**UI $\Delta$ N** <50V

**30mA RCD TYP A**

**$t_a$**  >0ms <300ms

**Limits**

**$I_{\Delta}$**  >15.0mA <30.0mA

**RE** < 3  $\Omega$

**UN** 230V **fN** 50.0Hz

**23 ms**

**14.7 mA**

## 19.8 Testing Residual Current Monitors – RCM Function ( PROFITEST MXTRA only)

### General

Residual current monitors (RCMs) monitor residual current in electrical systems and display it continuously. As is also the case with residual current devices, external switching devices can be controlled in order to shut down supply power in the event that a specified residual current value is exceeded.

However, the advantage of an RCM is that the user is informed of fault current within the system before shutdown takes place.

As opposed to individual measurement of  $I_{\Delta N}$  and  $t_A$ , measurement results must be evaluated manually in this case.

If an RCM is used in combination with an external switching device, the combination must be tested as if it were an RCD.

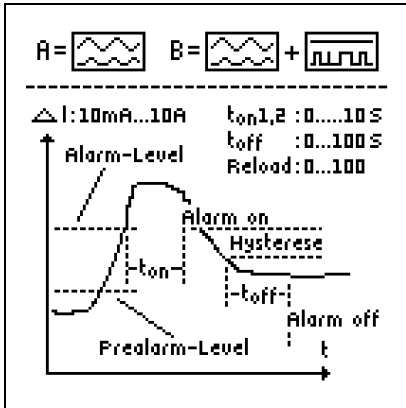

### Connection

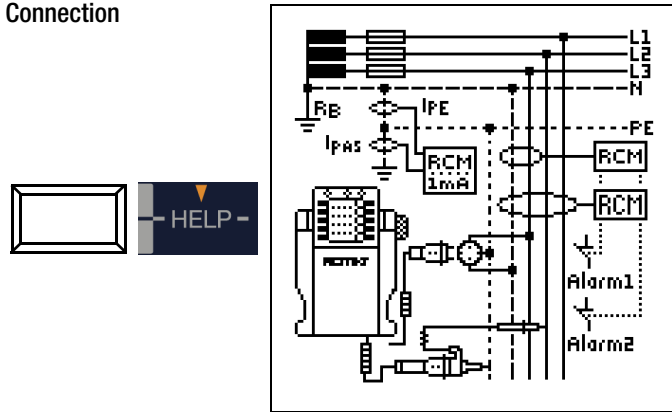

### Measure Touch Voltage

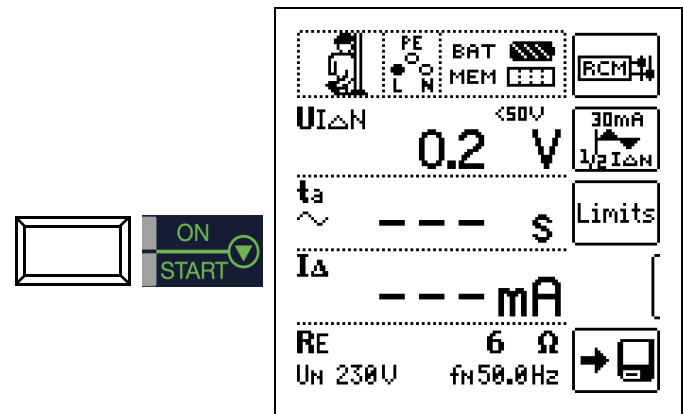

### No-Trip Test with $\frac{1}{2} \times I_{\Delta N}$ and 10 s

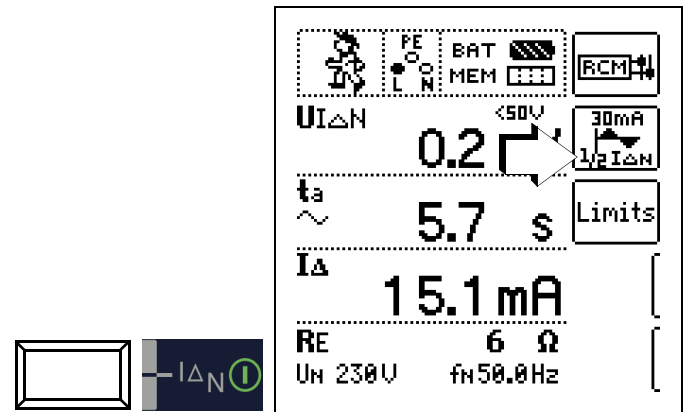

After 10 seconds have elapsed, no residual current may be indicated. The measurement must then be evaluated. In the event that "NOT OK" is selected (in case of false alarm), an error is indicated by the UL/RL LED which lights up red.

The measured value cannot be saved to memory and included in the test report until it has been evaluated.

### Set Parameters for $I_{\Delta N}$

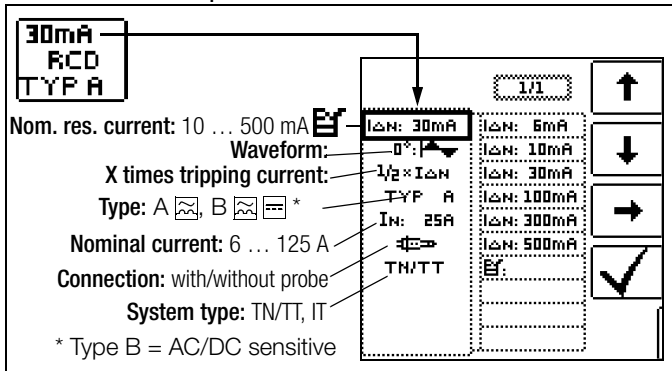

### Tripping test with $1 \times I_{\Delta N}$

– Measurement of Signal Response Time (Stopwatch Function) with Residual Current Generated by the Test Instrument

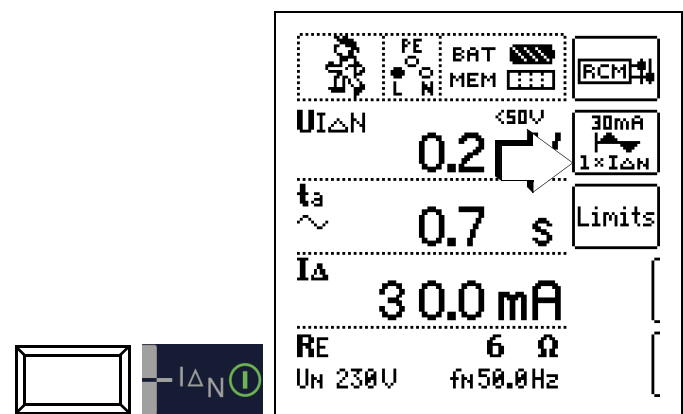

Measurement must be stopped manually by pressing the ON/START  $\blacktriangledown$  or  $I_{\Delta N}$  key immediately after indication of residual current, in order to document tripping time.

In the event that NOT OK is selected, an error is indicated by the UL/RL LED which lights up red.

The measured value cannot be saved to memory and included in the test report until it has been evaluated.

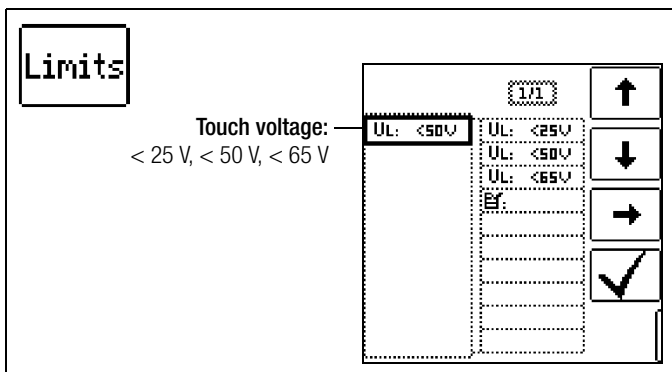

## 19.9 Checking the Operating Statuses of Electric Vehicles at Charging Stations per IEC 61851 ((PROFITEST MTECH+ & PROFITEST MXTRA)

A charging station is a facility designed to charge electric vehicles in accordance with IEC 61851-1, and is equipped with essential elements including a plug connector, conductor protection, an RCD, a circuit breaker and a safety communication device (PWM). Depending on where it's used, other function modules may be added, for example for mains connection and metering.

### Selecting the Adapter (test box)

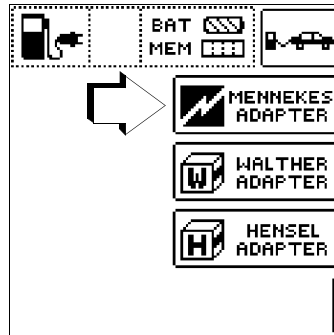

### Simulation of Operating Statuses per IEC 61851-1 with the MENNEKES Test Box

(Statuses A through E)

The MENNEKES test box is used exclusively to simulate the various operating statuses of a fictitious electric vehicle connected to a charging station. Settings for the simulated operating statuses can be found in the operating instructions for the test box.

The simulated operating statuses can be saved to as a visual inspection and documented in the report generating program.

Select the respective status to be checked with the **SELECT STATUS** key at the test instrument.

### Status A – charging cable connected to charging point only

- CP signal is activated.
- Voltage between PE and CP is 12 V.

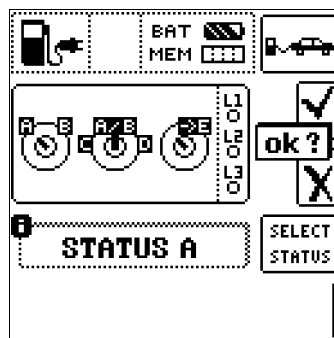

### Status B – charging cable connected to charging point and vehicle

- Charging cable is locked into place at the charging point and the vehicle.
- Vehicle is not yet ready for charging.
- Voltage between PE and CP: +9 V / -12 V

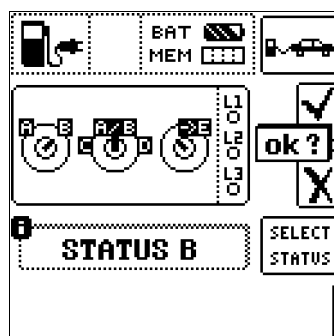

### Status C – non-gassing vehicle detected

- Vehicle is ready for charging / power is connected
- Voltage between PE and CP: +6 V / -12 V

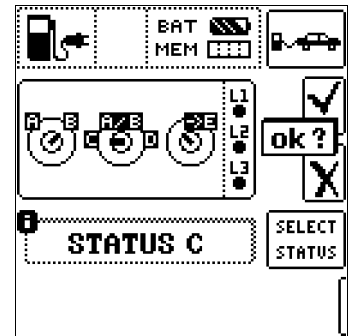

### Status D – gassing vehicle detected

- Vehicle is ready for charging / power is connected
- Voltage between PE and CP: +3 V / -12 V

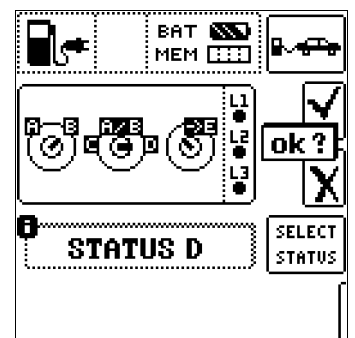

### Status E – cable is damaged

- Short-circuit between PE and CP
- Charging cable is unlocked at the charging point.
- Voltage between PE and CP is +0 V.

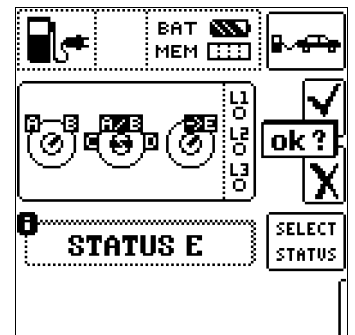

### Semi-Automatic Changing of Operating Statuses

As an alternative to manual status changing via the parameters menu for the **SELECT STATUS** softkey at the test instrument, quick and convenient switching amongst the statuses is also possible. The **AUTO** status parameter has to be selected to this end. After responding to the visual inspection prompt and saving the results, automatic switching to the next status ensues – the **01/05** key display corresponds to A/E (01 = A, 02 = B, 03 = C, 04 = D, 05 = E).

Status variants can be skipped by pressing the **I<sub>AN</sub>** key at the test instrument or the test plug.

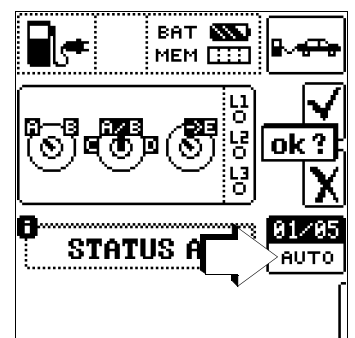

## 19.10 PRCD – Test Sequences for Documenting Fault Simulations at PRCDs with the PROFITEST PRCD Adapter (PROFITEST MXTRA only)

The PROFITEST PRCD test adapter can be used in combination with the test instrument.



### Attention!

Read the respective operating instructions before using the PROFITEST PRCD.

Measurements with the PROFITEST PRCD connected to the test instrument:

- Measurement of the PRCD's insulation resistance using the test instrument's  $R_{INS}$  function (see section 16).
- Measurement of the PRCD's protective conductor resistance using the test instrument's  $R_{LO}$  function. Please note that the protective conductor measurement is a modified RLO measurement with ramp sequence for PRCDs (see section 17).
- Tripping test with nominal residual current using the test instrument's  $I_F$  function (see section 12.3).
- Measurement of time to trip using the test instrument's  $I_{\Delta N}$  function (see section 12.3).
- Varistor test for PRCD-K: measurement via ISO ramp (see section 16).

Testing performed by simulating faults is carried out without connection to the test instrument, but it's accompanied and documented by the test instrument. The test sequence is opened in the test instrument to this end and the specified steps are executed at the PROFITEST PRCD. Afterwards, evaluation and assessment of each test step (OK or not OK) is performed at the test instrument for later documentation.

There are three preset test sequences:

- PRCD-S (single-phase / 3-pole): 11 test steps
- PRCD-K (single-phase / 3-pole): 4 test steps
- PRCD-S (3-phase / 5-pole): 18 test steps

## 19.10.1 Fault Simulation

The procedure for the PROFITEST PRCD, including the procedure with the device under test, is described in the operating instructions for the PROFITEST PRCD. This section describes the procedure for the test instrument.

### Procedure

- Prepare error simulation at the PROFITEST PRCD. Refer to the operating instructions for the PROFITEST PRCD.
- Select the test sequence at the test instrument.
- Execute each of the test sequence steps at the PROFITEST PRCD and document evaluation and assessment at the test instrument.

### Select the PRCD to be Tested

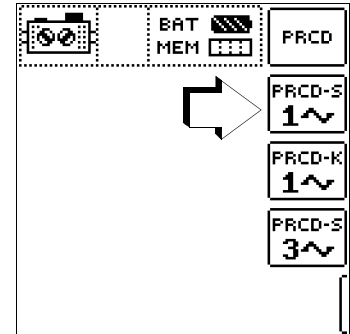

### Interaction Between PROFITEST PRCD and Test Instrument

Switch Position at PROFITEST PRCD	Display at Test Instrument		Meaning
	Test Step	Icon	
	ON	1~ON	Single-phase PRCD activated
	ON	3~ON	3-phase PRCD activated
	BREAK Lx		Interrupted phase
	Lx <-> PE Lx <-> N		Wires reversed between phase conductor and PE or neutral conductor
PE-U <sub>EXT</sub>	U <sub>ext</sub> -> PE	PE-U <sub>EXT</sub>	PE to phase
	PROBE		Contact ON key on PRCD with probe
	PRCD-Ip		Protective conductor current measurement with current clamp transformer
—	AUTO	AUTO	Semi-automatic change of fault simulations

The test steps are displayed at the test instrument. Their meanings and the associated switch positions at the PROFITEST PRCD are listed in the above table.

## Overview of Test Sequences and their Test Steps

PRCD-S, single-phase: 11 test steps

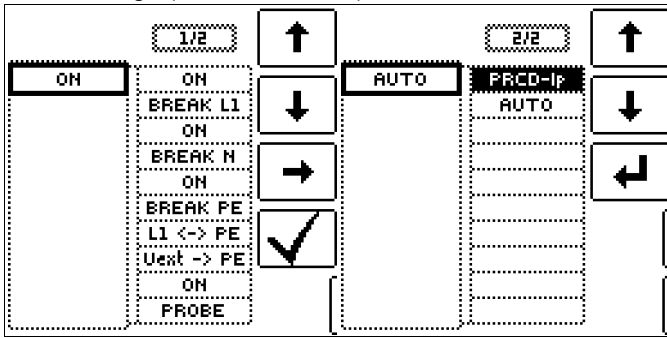

PRCD-S, 3-phase: 18 test steps

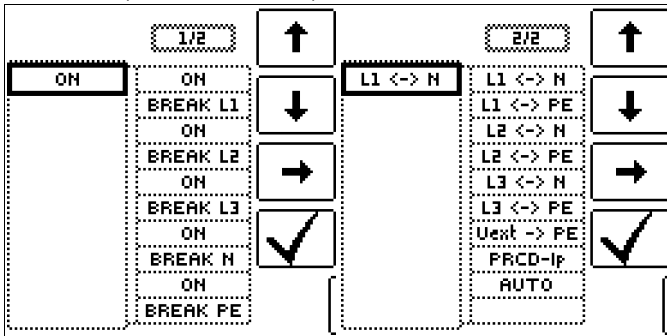

PRCD-K, single-phase: 5 test steps

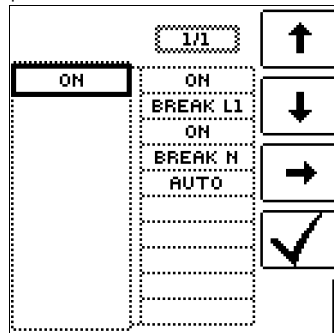

## Selection Examples, PRCD-S Test Sequence (single-phase) – 11 Test Steps

Simulation of Interruption (steps 1 to 6)

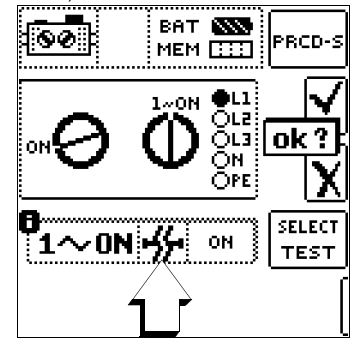

Reversed Conductor Simulation (step 7)

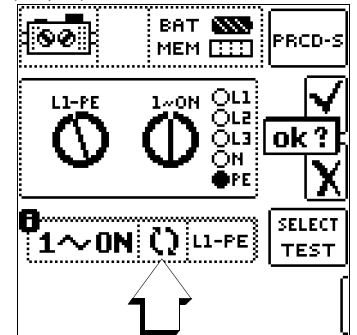

Simulation of PE to Phase (step 8)

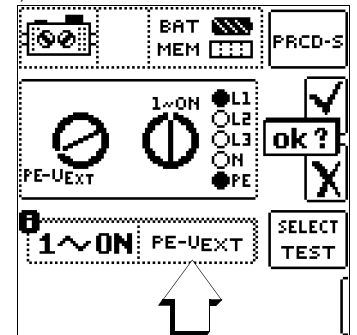

Contact ON Key at PRCD with Probe (step 10)

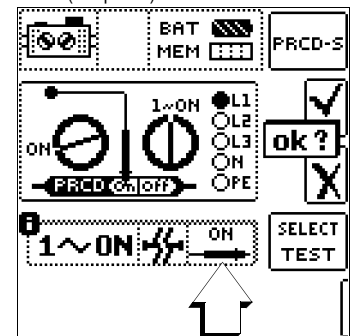

Measurement of Protective Conductor Current with a Current Clamp Transformer (step 11)

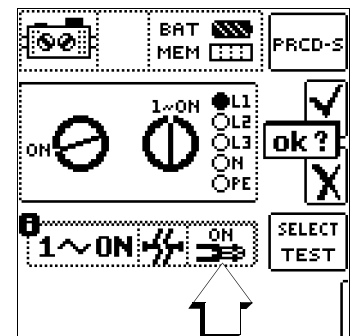

## Selection Examples, PRCD-S Test Sequence (3-phase) – 18 Test Steps

Simulation of Interruption (steps 1 to 10)

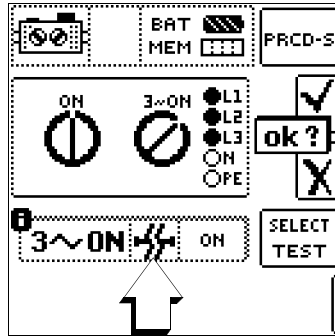

Reversed Conductor Simulation (steps 11 to 16)

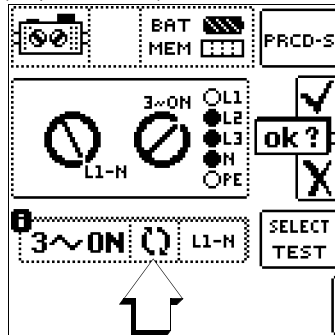

Simulation of PE to Phase (step 17)

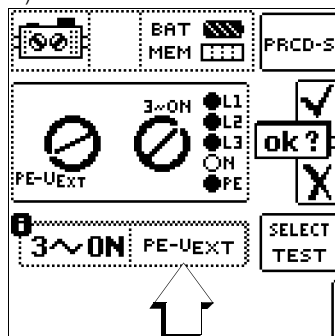

Measurement of Protective Conductor Current with a Current Clamp Transformer (step 18)

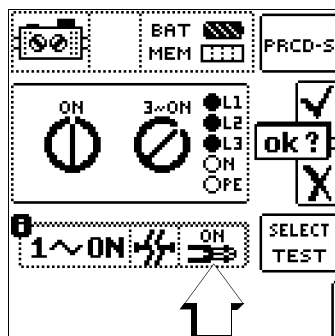

## Semi-Automatic Changing of Fault Simulations (Statuses)

As an alternative to manual status changing via the parameters menu for the respective PRCD selection at the test instrument (PRCD-S 1~, PRCD-K 1~ or PRCD-S 3~), quick and convenient switching amongst the fault simulations is also possible. The AUTO status parameter has to be selected to this end. After responding to the visual inspection prompt and saving the results, automatic switching to the next fault simulation ensues.

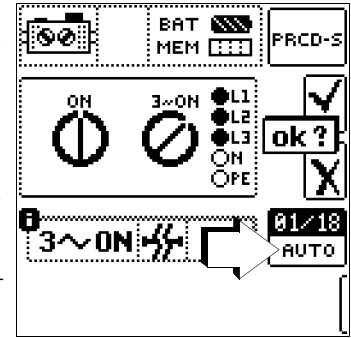

## Skipping Test Steps

Test steps can be skipped during fault simulation by pressing the  $I_{\Delta N}$  key at the test instrument or the test plug.

## 20 Test Sequences (Automatic Test Sequences) – AUTO Function

### Select AUTO Switch Position at the Test Instrument



With the rotary switch in the **AUTO** position, all of the test sequences in the device are displayed.

If there aren't any test sequences in the instrument, **NO DATA** appears.

### 20.1 General (test sequence layouts)

If the same sequence of tests will be run frequently (one after the other with subsequent report generation), for example as specified in the standards, it's advisable to make use of test sequences.

Automated test sequences can be compiled from manually created individual measurements with the help of the test sequence function.

A test sequence consists of up to 200 individual steps, which are executed one after the other.

Fundamentally, differentiation is made amongst three types of individual steps:

- Note (**Visual Inspection** test step) Test sequences are interrupted when a pop-up message is displayed for the inspector. The test sequences is not resumed until the message has been acknowledged.  
Sample Message Before Insulation Resistance Measurement "Disconnect the device from the mains!"
- Visual inspection, testing and report generation: The test sequence is interrupted when a passed/failed evaluation is displayed. The comment and the results of the evaluation are saved to the database.
- Measurement ("**User-Evaluated Measurement**" test step): same as individual measurements with instruments with storage and parameters configuration

### 20.2 Creation of Test Sequences with ETC

The test sequences are created at the PC with the help of ETC software, and are then transferred to the test instrument.

Measurement parameters are also configured at the PC. However, parameters can be changed at the test instrument during the test sequence before the respective measurement is started. When the test step is started once more, the parameter settings specified in ETC are loaded again.

ETC does not subject the parameters to a plausibility check. As a result, the newly created test sequence should be checked at the test instrument before it's permanently added to the database.

Limit values are not currently set in ETC, and have to be adjusted during the automatic test.

Accessing the Menu for Editing Test Sequences

In order to be able to edit existing test sequences (e.g. add test steps or change parameter settings), they first have to be loaded to ETC.

There are two ways to do this:

- ETC: Extras → Test Sequences → Load Test Sequences (from the file "test\_sequence\_xyz.seq")

or

- ETC: Device → Test Sequences → Receive Test Sequences (from the connected test instrument)

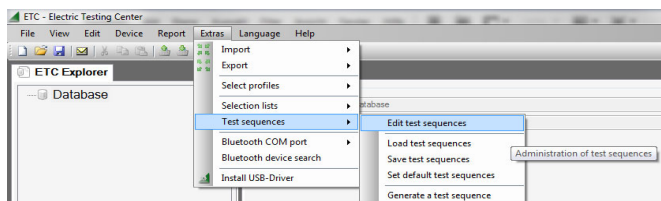

## Operating Overview: Creating Test Sequences at a PC

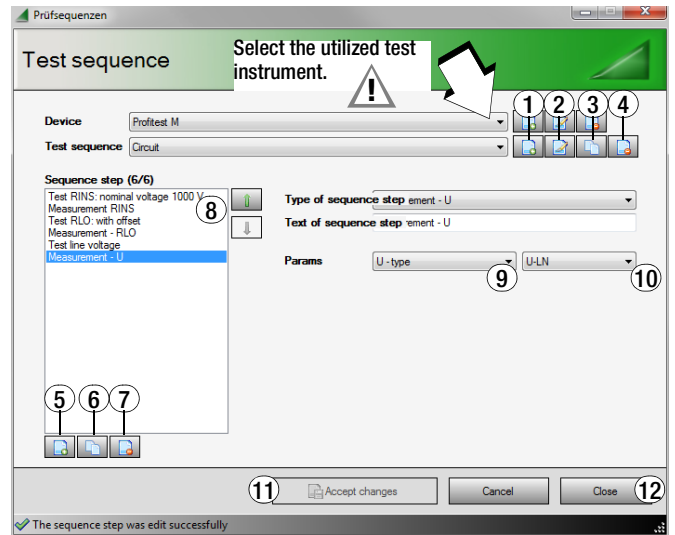

- 1 Create a new test sequence – enter a designation.
- 2 Change the designation of the selected test sequence.
- 3 Duplicate the selected test sequence, (Copy) is added to the name of the duplicated sequence.
- 4 Delete the selected test sequence.
- 5 Create or add a new test step for the selected test sequence. – Select the test step type from the list to this end and either accept or edit its designation.
- 6 Duplicate the selected test step.
- 7 Delete the selected test step.
- 8 Change position of the selected test step within the sequence.
- 9 Select test parameters for the selected test step type from the list.
- 10 Select a setting for the measuring parameter from the list.
- 11 Accept change to the measuring parameter.
- 12 Exit the test sequences menu.

### Saving Test Sequences in ETC to the PC

We recommend saving default test sequences, as well as edited and new test sequences, to the PC or to other data storage media using the desired filename (test\_sequence\_xyz.seq) with the help of the following menu command: Extras → Test Sequences → Save Test Sequences. Data loss resulting from certain administrative operations is prevented in this way (see following notes).

Due to the fact that only up to 10 test sequences, can be transferred to the test instrument, no more than 10 test sequences should be saved to any given file.

Test sequences which have been saved to a file can be reloaded to ETC at any time by clicking "Extras → Test Sequences → Load Test Sequences".

Sequences can be further edited by clicking "Extras → Test Sequences → Edit Test Sequences".

### Transferring Test Sequences from the PC to the Test Instrument

After executing the following ETC command, all previously created test sequences (up to 10) are transferred to the connected test instrument: "Device → Test Sequences → Send Test Sequences".

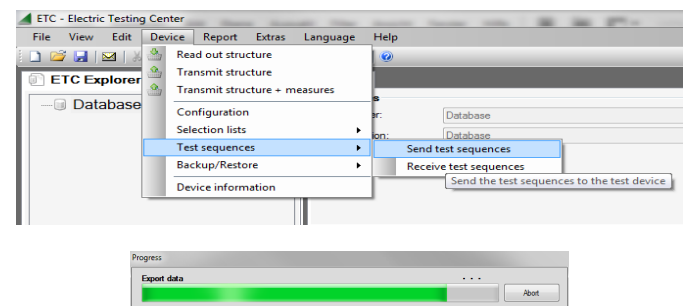



### Attention!

Test sequences which have been loaded to the test instrument are deleted when:

- New test sequences are received from the PC
- Selection lists are received from the PC
- Backup data is restored to the test instrument
- The user interface language is changed
- The test instrument's entire database is deleted
- The test instrument is reset to its default settings
- The firmware is updated

For as long as the test sequences are being transferred, a progress bar is displayed at the PC and the illustration shown to the right appears at the test instrument's display.

After data transmission has been completed, the display is switched to the **database** memory menu.

The display is returned to the measuring menu for the respective switch position by clicking **ESC**.

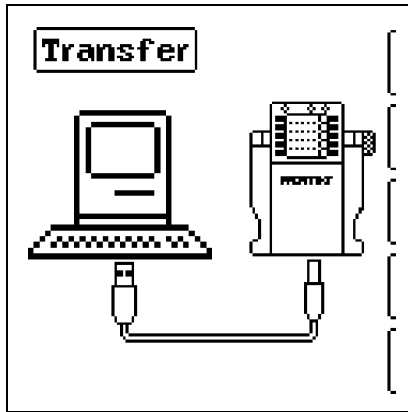

The selected test sequence (**SEQU.1** in this case) is started with the **ON/START** key.

When a test step of the measurement type is executed, the same screen layout appears as is also the case for individual measurements. The current test step number appears in the header instead of the memory and battery icons. After pressing the **Save** key twice, the next test step is displayed.

### Setting Parameters and Limit Values

Parameters and limit values can also be changed while a test sequence is running or before the respective measurement is started. The respective change only affects the active test sequence and is not saved.

### Skipping Test Steps

There are two ways to skip test steps or individual measurements:

- Select the test sequence, change to the test step column at the right with the help of the cursor, select the x<sup>th</sup> test step and press the **ON/START** key.
- The navigation menu can be opened within the test sequence by pressing the navigation key (cursor left-right). Jumping to the next or the previous test step is possible using the separate scroll keys which then appear.

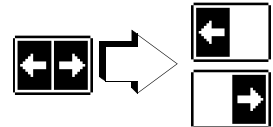

The navigation menu can be exited again and the current test step can be displayed by pressing the **ESC** key.

## 20.3 Using Test Sequences

### Test Sequence Commands

Acknowledge message

Discard event

Confirm event

To previous / to next step

Save measurement results

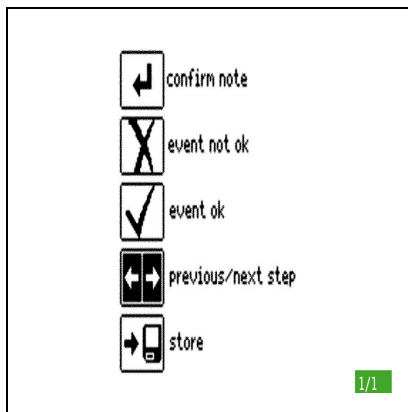

### Aborting or Ending a Test Sequence

An active sequence can be aborted by pressing the **ESC** key and then acknowledging.

**Sequence Ended** appears after the last test step is completed. The initial menu, **List of Test Sequences**, is once again displayed after acknowledging the prompt.

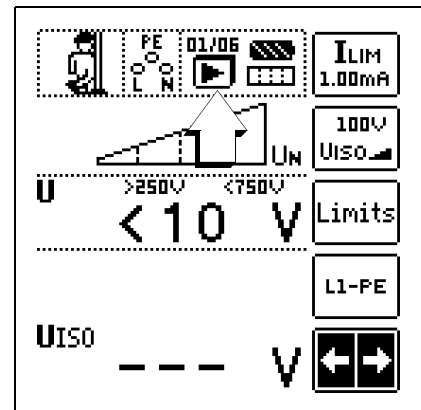

### Configuring Test Sequence Parameters

Measurement parameters are also configured at the PC. However, parameters can be changed at the test instrument during the test sequence before the respective measurement is started.

### Selecting and Starting a Test Sequence at the Test Instrument

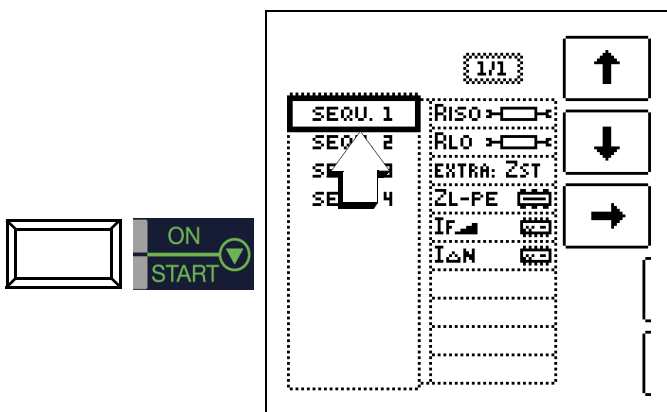



## 21 Maintenance

### 21.1 Test Instrument Firmware/Software

The layout of the test instruments makes it possible to adapt device software to the latest standards and regulations. Beyond this, suggestions from customers result in continuous improvement of the test instrument software, as well as new functions.

#### Query Current Status

- Turn the rotary switch to the **SETUP** position.
- Press the **SW-Info CALIBRATION** key.

SW-INFO	
DEVICE TYPE	M520P
SERIAL NUMBER	NoSerial
SW1 00.00.00	HW1 00.00.00
SW2 03.13.461	HW2 946.10.4
SW3 05.65.33	HW3 948.10.04
SW4 04.09.02	HW4 950.10.04
CALIBRATION DATE	06.07.2011
ADJUSTMENT DATE	06.07.2011

- Press any key in order to return to the main menu.

#### Update

Internal test instrument firmware/software can be updated via the USB port with the help of a PC and an interface cable.

The firmware/software with the required version is transferred to the test instrument with the help of the MASTER Updater Software-Tool. Currently installed test instrument firmware/software is overwritten.

The MASTER Updater can be downloaded free of charge from [www.gossenmetrawatt.com](http://www.gossenmetrawatt.com). Registration with myGMC is required to this end. Operating instructions for the Firmware Update Tool are available here as well.



#### Note

Prerequisite for transfer:  
The rotary selector switch is not set to the **U** position.

- Establish a USB connection between the PC and the test instrument.
- Switch the PC and the test instrument on.
- Follow the instructions displayed by the MASTER Updater and the associated operating instructions.

#### 21.1.1 Rechargeable Battery Care

Check to make sure that no leakage has occurred at the rechargeable batteries at short, regular intervals, or after the instrument has been in storage for a lengthy period of time.



#### Note

Remove rechargeable batteries during lengthy periods of non-use (e.g. vacation). This prevents excessive depletion or leakage, which may result in damage to the test instrument.

#### 21.2 Fuse Replacement

If a fuse has blown due to overloading, a corresponding message error appears at the display panel. The instrument's voltage measuring ranges are nevertheless still functional.

- Disconnect the device from the measuring circuit at all poles!
- Loosen the slotted screws at the fuse compartment lid next to the mains power cable with a screwdriver. The fuses are now accessible.
- Replacement fuses can be accessed after opening the battery compartment lid.



#### Attention!

Severe damage to the instrument may occur if incorrect fuses are used.

Only original fuses from Gossen Metrawatt GmbH may be used (order no. 3-578-285-01 / SIBA 7012540.3.15 SI-EINSATZ FF 3.15/500 6.3X32).

Only original fuses assure required protection by means of suitable blowing characteristics. Short-circuiting of fuse terminals or the repair of fuses is prohibited, and is life endangering!

The instrument may be damaged if fuses with incorrect ampere ratings, breaking capacities or blowing characteristics are used!

- Remove the blown fuse and insert a new one.
- Insert the fuse compartment lid after the fuse has been replaced and secure it by turning clockwise.

#### 21.3 Housing

No special maintenance is required for the housing.

Keep outside surfaces clean. Use a slightly dampened cloth for cleaning. In particular for the protective rubber surfaces, we recommend a moist, lint-free microfiber cloth. Avoid the use of cleansers, abrasives or solvents.

#### 21.4 Calibration

Use of your instrument and resultant stressing influence the instrument and lead to deviation from warranted accuracy values. In the case of strict measuring accuracy requirements, as well as in the event of severe stressing (e.g. severe climatic or mechanical stress), we recommend a relatively short calibration interval of once per year. If this is not the case, a calibration interval of 2 to 3 years is usually adequate.

Please contact GMC-I Service GmbH for calibration services (see section 22, "Contact, Support and Service", on page 98).

A sticker with an instrument-specific guideline value for the calibration interval and information regarding the service provider is included on the instrument as an aid.



#### Note

##### Date on Calibration Certificate / Calibration Interval Begins Upon Receipt

Your instrument is furnished with a calibration certificate on which a date appears. This date may be further in the past if your instrument has been stored for some time prior to sale.

The instruments are stored in accordance with the specified conditions. Drift is thus negligible for a duration of 1 year. Longer storage periods are highly unusual. Consequently, the instrument's characteristic values lie within the specifications and the first calibration interval can be determined as of the date of receipt.

## 22 Contact, Support and Service

Gossen Metrawatt GmbH can be reached directly and simply – we have a single number for everything! Whether you require support or training, or have an individual inquiry, we can answer all of your questions here:

+49-911-8602-0

Monday to Thursday: 8 a.m. to 4 p.m.

Friday: 8 a.m. to 2 p.m.

Or contact us by e-mail at:

[info@gossenmetrawatt.com](mailto:info@gossenmetrawatt.com)

Do you prefer support by e-mail?

Measuring and Test Technology:

[support@gossenmetrawatt.com](mailto:support@gossenmetrawatt.com)

Industrial Measuring Technology:

[support.industrie@gossenmetrawatt.com](mailto:support.industrie@gossenmetrawatt.com)

Enquiries concerning training and seminars can also be submitted by e-mail and online:

[training@gossenmetrawatt.com](mailto:training@gossenmetrawatt.com)

<https://www.gossenmetrawatt.com/training>



Please contact GMC-I Service GmbH for repairs, replacement parts and calibration<sup>1)</sup>:

+49-911-817718-0

[service@gossenmetrawatt.com](mailto:service@gossenmetrawatt.com)

[www.gmci-service.com](http://www.gmci-service.com)

Beuthener Str. 41

90471 Nürnberg

Germany



## 23 CE Declaration

The instrument fulfills all requirements of applicable EU directives and national regulations. We confirm this with the CE mark. The CE declaration is available upon request.

A calibration certificate is included with the instrument.

---

<sup>1)</sup> DAkkS calibration laboratory per DIN EN ISO/IEC 17025 – accredited by the Deutsche Akkreditierungsstelle GmbH under reference number D-K-15080-01-01.

## 24 Disposal and Environmental Protection

Proper disposal makes an important contribution to the protection of our environment and the conservation of natural resources.



### Attention!

Environmental Damage  
Improper disposal results in environmental damage.  
Follow the instructions concerning return and disposal included in this section.

---

The following comments refer specifically to the legal situation in the Federal Republic of Germany. Owners or end users who are subject to other national requirements are required to comply with the respectively applicable national requirements and to implement them correctly on site. Relevant information can be obtained, for example, from the responsible national authorities or national distributors.

### Waste Electrical Equipment, Electrical or Electronic Accessories and Waste Batteries (including rechargeable batteries)

Electrical equipment and batteries (including rechargeable batteries) contain valuable raw materials that can be recycled, as well as hazardous substances which can cause serious harm to human health and the environment, and they must be recycled and disposed of correctly.

The symbol on the left depicting a crossed-out garbage can on wheels refers to the legal obligation of the owner or end user (German electrical and electronic equipment act ElektroG and German battery act BattG) not to dispose of used electrical equipment and batteries with unsorted municipal waste ("household trash"). Waste batteries must be removed from the old device (where possible) without destroying them and the old device and the waste batteries must be disposed of separately. The battery type and its chemical composition are indicated on the battery's labelling. If the abbreviations "Pb" for lead, "Cd" for cadmium or "Hg" for mercury are included, the battery exceeds the limit for the respective metal.



Please observe the owner's or end user's responsibility with regard to deleting personal data, as well as any other sensitive data, from old devices before disposal.

Old devices, electrical or electronic accessories and waste batteries (including rechargeable batteries) used in Germany can be returned free of charge to Gossen Metrawatt GmbH or the service provider responsible for their disposal in compliance with applicable regulations, in particular laws concerning packaging and hazardous goods. Further information regarding returns can be found on our website.

### Packaging Materials

We recommend retaining the respective packaging materials for the case that you might require servicing or calibration in the future.



### Attention!

Danger of Asphyxiation Resulting from Foils and Other Packaging Materials  
Children and other vulnerable persons may suffocate if they wrap themselves in packaging materials, or their components or foils, or if they pull them over their heads or swallow them.  
Keep packaging materials, as well as their components and foils, out of the reach of babies, children and other vulnerable persons.

---

In accordance with German packaging law (VerpackG), the user is obligated to correctly dispose of packaging and its components separately, and not together with unsorted municipal waste ("household trash").

Private end consumers can dispose of packaging free of charge at the responsible collection point. Packaging which is not subject to so-called system participation is returned to the appointed service provider. Further information regarding returns can be found on our website.

## 25 Appendix

### 25.1 Tables for Determining Maximum and Minimum Display Values in Consideration of the Instrument's Maximum Measuring and Intrinsic Uncertainties

Table 1

$Z_{L-PE}$ (full-wave) / $Z_{L-N}$ ( $\Omega$ )		$Z_{L-PE}$ (+/- half-wave) ( $\Omega$ )	
Limit Value	Max. Display Value	Limit Value	Max. Display Value
0.10	0.07	0.10	0.05
0.15	0.11	0.15	0.10
0.20	0.16	0.20	0.14
0.25	0.20	0.25	0.18
0.30	0.25	0.30	0.22
0.35	0.30	0.35	0.27
0.40	0.34	0.40	0.31
0.45	0.39	0.45	0.35
0.50	0.43	0.50	0.39
0.60	0.51	0.60	0.48
0.70	0.60	0.70	0.56
0.80	0.70	0.80	0.65
0.90	0.79	0.90	0.73
1.00	0.88	1.00	0.82
1.50	1.40	1.50	1.33
2.00	1.87	2.00	1.79
2.50	2.35	2.50	2.24
3.00	2.82	3.00	2.70
3.50	3.30	3.50	3.15
4.00	3.78	4.00	3.60
4.50	4.25	4.50	4.06
5.00	4.73	5.00	4.51
6.00	5.68	6.00	5.42
7.00	6.63	7.00	6.33
8.00	7.59	8.00	7.24
9.00	8.54	9.00	8.15
9.99	9.48	9.99	9.05

Table 3

$R_{INS}$ M $\Omega$			
Limit Value	Min. Display Value	Limit Value	Min. Display Value
0.10	0.12	10.0	10.7
0.15	0.17	15.0	15.9
0.20	0.23	20.0	21.2
0.25	0.28	25.0	26.5
0.30	0.33	30.0	31.7
0.35	0.38	35.0	37.0
0.40	0.44	40.0	42.3
0.45	0.49	45.0	47.5
0.50	0.54	50.0	52.8
0.55	0.59	60.0	63.3
0.60	0.65	70.0	73.8
0.70	0.75	80.0	84.4
0.80	0.86	90.0	94.9
0.90	0.96	100	106
1.00	1.07	150	158
1.50	1.59	200	211
2.00	2.12	250	264
2.50	2.65	300	316
3.00	3.17		
3.50	3.70		
4.00	4.23		
4.50	4.75		
5.00	5.28		
6.00	6.33		
7.00	7.38		
8.00	8.44		
9.00	9.49		

Table 2

$R_E / R_{ELoop}$ ( $\Omega$ )					
Limit Value	Max. Display Value	Limit Value	Max. Display Value	Limit Value	Max. Display Value
0.10	0.07	10.0	9.49	1.00 k	906
0.15	0.11	15.0	13.6	1.50 k	1.36 k
0.20	0.16	20.0	18.1	2.00 k	1.81 k
0.25	0.20	25.0	22.7	2.50 k	2.27 k
0.30	0.25	30.0	27.2	3.00 k	2.72 k
0.35	0.30	35.0	31.7	3.50 k	3.17 k
0.40	0.34	40.0	36.3	4.00 k	3.63 k
0.45	0.39	45.0	40.8	4.50 k	4.08 k
0.50	0.43	50.0	45.4	5.00 k	4.54 k
0.60	0.51	60.0	54.5	6.00 k	5.45 k
0.70	0.60	70.0	63.6	7.00 k	6.36 k
0.80	0.70	80.0	72.7	8.00 k	7.27 k
0.90	0.79	90.0	81.7	9.00 k	8.17 k
1.00	0.88	100	90.8	9.99 k	9.08 k
1.50	1.40	150	133		
2.00	1.87	200	179		
2.50	2.35	250	224		
3.00	2.82	300	270		
3.50	3.30	350	315		
4.00	3.78	400	360		
4.50	4.25	450	406		
5.00	4.73	500	451		
6.00	5.68	600	542		
7.00	6.63	700	633		
8.00	7.59	800	724		
9.00	8.54	900	815		

Table 4

$R_{LO}$ $\Omega$			
Limit Value	Max. Display Value	Limit Value	Max. Display Value
0.10	0.07	10.0	9.59
0.15	0.12	15.0	14.4
0.20	0.17	20.0	19.2
0.25	0.22	25.0	24.0
0.30	0.26	30.0	28.8
0.35	0.31	35.0	33.6
0.40	0.36	40.0	38.4
0.45	0.41	45.0	43.2
0.50	0.46	50.0	48.0
0.60	0.55	60.0	57.6
0.70	0.65	70.0	67.2
0.80	0.75	80.0	76.9
0.90	0.84	90.0	86.5
1.00	0.94	99.9	96.0
1.50	1.42		
2.00	1.90		
2.50	2.38		
3.00	2.86		
3.50	3.34		
4.00	3.82		
4.50	4.30		
5.00	4.78		
6.00	5.75		
7.00	6.71		
8.00	7.67		
9.00	8.63		

Table 5

Z <sub>ST</sub> kΩ	
Limit Value	Min. Display Value
10	14
15	19
20	25
25	30
30	36
35	42
40	47
45	53
50	58
56	65
60	69
70	80
80	92
90	103
100	114
150	169
200	253
250	315
300	378
350	440
400	503
450	565
500	628
600	753
700	878
800	> 999

Table 6

Short-circuit current minimum display values for the determination of nominal current for various fuses and breakers for systems with nominal voltage of U<sub>N</sub> = 230 V

Nominal Current I <sub>N</sub> [A]	Low Resistance Fuses in Accordance with the DIN VDE 0636 Series of Standards Characteristic gL, gG, gM				With Circuit Breaker and Line Switch							
	Breaking Current I <sub>A</sub> 5 s		Breaking Current I <sub>A</sub> 0.4 s		Characteristic B/E (formerly L) Breaking Current I <sub>A</sub> 5 × I <sub>N</sub> (< 0.2 s/0.4 s)		Characteristic C (formerly G, U) Breaking Current I <sub>A</sub> 10 × I <sub>N</sub> (< 0.2 s/0.4 s)		Characteristic D Breaking Current I <sub>A</sub> 20 × I <sub>N</sub> (< 0.2 s/0.4 s)		Characteristic K Breaking Current I <sub>A</sub> 14 × I <sub>N</sub> (< 0.2 s/0.4 s)	
	Limit Value [A]	Min. Display [A]	Limit Value [A]	Min. Display [A]	Limit Value [A]	Min. Display [A]	Limit Value [A]	Min. Display [A]	Limit Value [A]	Min. Display [A]	Limit Value [A]	Min. Display [A]
	2	9.2	10	16	17	10	11	20	21	40	42	28
3	14.1	15	24	25	15	16	30	32	60	64	42	44
4	19	20	32	34	20	21	40	42	80	85	56	59
6	27	28	47	50	30	32	60	64	120	128	84	89
8	37	39	65	69	40	42	80	85	160	172	112	119
10	47	50	82	87	50	53	100	106	200	216	140	150
13	56	59	98	104	65	69	130	139	260	297	182	196
16	65	69	107	114	80	85	160	172	320	369	224	243
20	85	90	145	155	100	106	200	216	400	467	280	319
25	110	117	180	194	125	134	250	285	500	578	350	402
32	150	161	265	303	160	172	320	369	640	750	448	520
35	173	186	295	339	175	188	350	405	700	825	490	571
40	190	205	310	357	200	216	400	467	800	953	560	657
50	260	297	460	529	250	285	500	578	1000	1.22 k	700	834
63	320	369	550	639	315	363	630	737	1260	1.58 k	882	1.07 k
80	440	517									1120	1.40 k
100	580	675									1400	1.80 k
125	750	889									1750	2.34 k
160	930	1.12 k									2240	3.18 k

Example

Display value of 90.4 A → next lower value for circuit breaker characteristic B from table: 85 A → nominal current (I<sub>N</sub>) of the protective device: max. 16 A

## 25.2 At which values should/must an RCD actually be tripped? Requirements for Residual Current Devices (RCD)

### General Requirements

- Tripping must occur no later than upon occurrence of rated residual current (nominal differential current  $I_{\Delta N}$ ).

and

- Maximum time to trip may not be exceeded.

### Additional requirements due to influences on the tripping current range and the point in time of tripping which have to be taken into consideration:

- Residual current type or waveform:  
This results in a reliable tripping current range.
- Mains type and line voltage:  
This results in maximum tripping time.
- RCD variant (standard or selective):  
This results in maximum tripping time.

### Note on RCCBs:

Testing of RCCBs is conducted in accordance with the specifications set forth in DIN EN 61008-1 (VDE 0664-10) and DIN EN IEC 61008-2-1 (VDE 0664-1).

### Definitions of Requirements in the Standards

VDE 0100-600 (IEC 60364-6), which is included in all German standards collections for electricians, applies to measurements in electrical systems. It plainly states: "The effectiveness of the protective measure is substantiated when disconnection occurs no later than upon occurrence of rated differential current  $I_{\Delta N}$ ."

As a requirement for the measuring instrument manufacturer, DIN EN 61557-6 (VDE 0413-6) unmistakably specifies:

"The measuring instrument must be capable of substantiating the fact that the residual current which trips the residual current device (RCD) is less than or equal to rated residual current."





### Comment

For all electricians, this means that during required protective measures testing after system modifications or additions to the system, as well as after repairs or during the E-check conducted after measurement of touch voltage, the tripping test must be conducted no later than upon reaching a value of, depending upon the RCD, 10, 30, 100, 300 or 500 mA.

How does the electrician react in the event that these values are exceeded? The RCD is replaced!

If it was relatively new, a complaint is submitted to the manufacturer. And in his lab the manufacturer determines: The RCD complies with the manufacturer's standard and is OK.

A look at the VDE 0664-10/-20/-100/-200 manufacturer's standard shows us why:

Type of Residual Current	Residual Current Waveform	Permissible Tripping Current Range
Sinusoidal alternating current		$0.5 \dots 1 I_{\Delta N}$
Pulsating direct current (positive or negative half-waves)		$0.35 \dots 1.4 I_{\Delta N}$
Phase angle controlled half-wave currents Phase angle of $90^\circ$ el Phase angle of $135^\circ$ el		$0.25 \dots 1.4 I_{\Delta N}$ $0.11 \dots 1.4 I_{\Delta N}$
Pulsating direct current superimposed with 6 mA smooth, direct residual current		Max. $1.4 I_{\Delta N} + 6 \text{ mA}$
Smooth direct current		$0.5 \dots 2 I_{\Delta N}$

Because the current waveform plays a significant role, the current waveform used by the test instrument is also important.

Set residual current type or waveform at the test instrument:

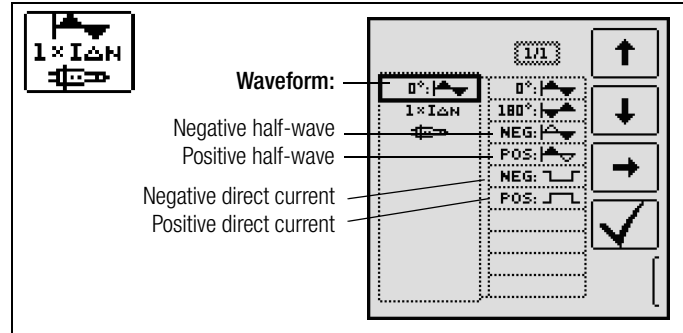

It's important to be able to select and take advantage of the corresponding settings at one's own test instrument.

The situation is similar for breaking times. The new VDE 0100-410 should also be included in the standards collection.

Depending upon mains type and line voltage, it specifies breaking times ranging from 0.1 to 5 seconds.

System	50 V < U <sub>0</sub> ≤ 120 V		120 V < U <sub>0</sub> ≤ 230 V		230 V < U <sub>0</sub> ≤ 400 V		U <sub>0</sub> > 400 V	
	AC	DC	AC	DC	AC	DC	AC	DC
TN	0.8 s		0.4 s	5 s	0.2 s	0.4 s	0.1 s	0.1 s
TT	0.3 s		0.2 s	0.4 s	0.07 s	0.2 s	0.04 s	0.1 s

RCDs usually interrupt more quickly, but in some cases they can take a bit longer. Once again, the ball is in the manufacturer's court.

The following table is also included in VDE 0664:

Design	Residual Current Type	Breaking Time at			
		$1 \times I_{\Delta N}$	$2 \times I_{\Delta N}$	$5 \times I_{\Delta N}$	500 A
	Alternating residual current	$1 \times I_{\Delta N}$	$2 \times I_{\Delta N}$	$5 \times I_{\Delta N}$	500 A
	Pulsating direct residual current	$1.4 \times I_{\Delta N}$	$2 \times 1.4 \times I_{\Delta N}$	$5 \times 1.4 \times I_{\Delta N}$	500 A
	Smooth, direct residual current	$2 \times I_{\Delta N}$	$2 \times 2 \times I_{\Delta N}$	$5 \times 2 \times I_{\Delta N}$	500 A
	Standard (undelayed) or briefly delayed	300 ms	Max. 0.15 s	Max. 0.04 s	Max. 0.04 s
	Selective	0.13 ... 0.5 s	0.06 ... 0.2 s	0.05 ... 0.15 s	0.04 ... 0.15 s

Two limit values are highly conspicuous:

Standard max. 0.3 s

Selective max. 0.5 s

All of the limit values are already included in good test instruments, or it's possible to enter them directly and they're displayed as well!

Select or set limit values at the test instrument:

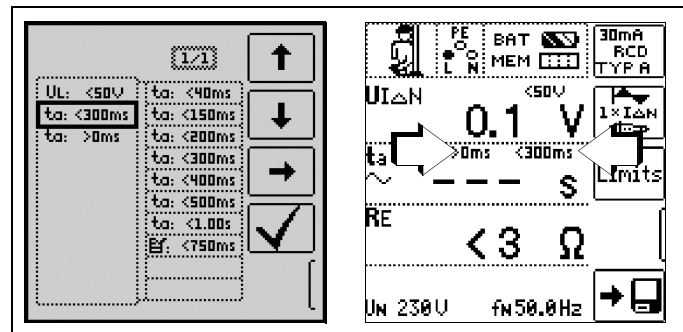

Tests for electrical systems include “visual inspection”, “testing” and “measurement”, and thus may only be conducted by experts with appropriate work experience.

In the final analysis, the values from VDE 0664 are technically binding.

### 25.3 Testing Electrical Machines per DIN EN 60204 – Applications, Limit Values

The PROFITEST PRIME AC test instrument has been developed for the testing of electrical machines and controllers. After a revision to the standard, measurement of loop impedance is now additionally required. Measurement of loop impedance, as well as other measurements required for the testing of electrical machines, can be performed with test instruments from the PROFITEST MASTER series.

#### Comparison of Tests Specified by the Standards

Testing per DIN EN 60204-1 (machines)	Testing per DIN EN 61557 (systems)	Measuring Function
Uninterrupted connection of a protective conductor	Part 4: Resistance of: – Ground conductor – Protective conductor – Equipotential bonding conductor	RLO
Loop Impedance	Part 3: Loop Impedance	ZL-PE
Insulation resistance	Part 2: Insulation resistance	RISO
Testing for dielectric strength	Part 14: Equipment for testing the safety of electrical equipment of machinery	—
Protection against residual voltage	Part 14: Equipment for testing the safety of electrical equipment of machinery	Ures
Function test	—	—

#### Uninterrupted connection of a protective conductor

Uninterrupted connection of a protective conductor system is tested here by using an alternating current of 0.2 to 10 A with a line frequency of 50 Hz.

(= low-resistance measurement) Testing must be conducted between the PE terminal and various points within the protective conductor system.

#### Loop Impedance Measurement

Loop impedance  $Z_{L-PE}$  is measured and short-circuit current  $I_{SC}$  is ascertained in order to determine if the breaking requirements for protective devices have been fulfilled (see section 13).

#### Insulation Resistance Measurement

All of the active conductors in the primary circuit are short-circuited at the machine (L and N, or L1, L2, L3 and N) and measured against PE (protective conductor). Controllers or machine components which are not laid out for these voltages (500 V DC) can be disconnected from the measuring circuit for the duration of the measurement. The measured value may not be any less than 1 MΩ. The test can be subdivided into separate segments.

#### Voltage Tests (with PROFITEST PRIME AC only)

The electrical equipment of the machine under test must withstand a test voltage of twice its own rated voltage value or 1000 V~ (whichever is greater) applied between the conductors of all circuits and the protective conductor system for a period of at least 1 second. The test voltage must have a frequency of 50 Hz, and must be generated by a transformer with a minimum power rating of 500 VA.

#### (Residual) Voltage Measurements

The EN 60204 standard specifies that after switching supply power off, residual voltage must drop to a value of 60 V or less within 5 seconds at all accessible, active components of a machine to which a voltage of greater than 60 V is applied during operation.

When conductors are exposed, residual voltage must drop to a value of less than or equal to 60 V within 1 second.

### Function Test

The machine is operated with nominal voltage and tested for correct functioning, in particular with regard to safety functions.

### Special Tests

- Pulse control mode for troubleshooting (with PROFITEST PRIME AC only)
- Protective conductor test with 25 A test current (with PROFITEST PRIME AC only)

### Limit Values per DIN EN 60204-1

Measurement	Parameters	Cross-Section	Standard Value
Protective conductor measurement	Test duration		10 s
	Limit value Protective conductor resistance based on phase conductor cross-section and characteristics of the overvoltage protection device (calculated value)	1.5 mm <sup>2</sup>	500 mΩ
		2.5 mm <sup>2</sup>	500 mΩ
		4.0 mm <sup>2</sup>	500 mΩ
		6.0 mm <sup>2</sup>	400 mΩ
		10 mm <sup>2</sup>	300 mΩ
		16 mm <sup>2</sup>	200 mΩ
		25 mm <sup>2</sup> L (16 mm <sup>2</sup> PE)	200 mΩ
		35 mm <sup>2</sup> L (16 mm <sup>2</sup> PE)	100 mΩ
		50 mm <sup>2</sup> L (25 mm <sup>2</sup> PE)	100 mΩ
70 mm <sup>2</sup> L (35 mm <sup>2</sup> PE)		100 mΩ	
95 mm <sup>2</sup> L (50 mm <sup>2</sup> PE)	050 mΩ		
120 mm <sup>2</sup> L (70 mm <sup>2</sup> PE)	050 mΩ		
Insulation resistance measurement	Nominal voltage		500 V DC
	Resistance limit value		≥ 1 MΩ
Leakage current measurement	Leakage current		2.0 mA
Protection against residual voltage	Discharge time after switching off supply power		5 s
	Discharge time after exposing conductors		1 s
Testing for dielectric strength	Test voltage		2 × U <sub>N</sub> or 1 kV
	Test voltage frequency		50 Hz or 60 Hz
	Test duration		1 s

### Overvoltage Protection Device Characteristics for Limit Value Selection for Protective Conductor Testing

Breaking Time, Characteristics	Available for Cross-Section
Fuse breaking time: 5 s	All cross-sections
Fuse breaking time: 0.4 s	1.5 through 16 sq. mm
Circuit breaker, characteristic B $I_a = 5 \times I_n$ - breaking time 0.1 s	1.5 through 16 sq. mm
Circuit breaker, characteristic C $I_a = 10 \times I_n$ - breaking time 0.1 s	1.5 through 16 sq. mm
Adjustable circuit breaker $I_a = 8 \times I_n$ - breaking time: 0.1s	All cross-sections

### 25.4 Periodic Testing per DGUV V 3 (previously BGV A3) – Limit Values for Electrical Systems and Operating Equipment

#### Limit Values per EN 50678 / DIN EN 50699

Maximum Permissible Limit Values for Protective Conductor Resistance for Connector Cables with Lengths of up to 5 m

Test Standard	Test Current	Open-circuit voltage	R <sub>SL</sub> Housing – Mains Plug
EN 50678 / DIN EN 50699	> 200 mA	4 V < U <sub>L</sub> < 24 V	0.3 Ω <sup>1</sup> + 0.1 Ω <sup>2</sup> for each additional 7.5 m

<sup>1</sup> This value may not exceed 1 Ω for permanently connected data processing systems (EN 50678 / DIN EN 50699).

<sup>2</sup> Total protective conductor resistance: max. 1 Ω

### Minimum Permissible Limit Values for Insulation Resistance

Test Standard	Test Voltage	R <sub>ISO</sub>			
		PC I	PC II	PC III	Heating
EN 50678 / DIN EN 50699	500 V	1 MΩ	2 MΩ	0.25 MΩ	0.3 MΩ *

\* With activated heating elements (where heating power > 3.5 kW and R<sub>ISO</sub> < 0.3 MΩ: leakage current measurement is required)

### Maximum Permissible Limit Values for Leakage Current in mA

Test Standard	I <sub>PE</sub>	I <sub>C</sub>	I <sub>DI</sub>
EN 50678 / DIN EN 50699	PC I: 3.5 1 mA/kW *	0.5	PC I: 3.5 1 mA/kW * PC II: 0.5

\* For devices with heating power of greater than 3.5 kW

Note 1: Devices which are not equipped with accessible parts that are connected to the protective conductor, and which comply with requirements for housing leakage current and, if applicable, patient leakage current, e.g. computer equipment with shielded power pack

Note 2: Permanently connected devices with protective conductor

Note 3: Portable X-ray devices with mineral insulation

I<sub>B</sub> Housing leakage current (probe or touch current)

I<sub>DI</sub> Residual current

I<sub>SL</sub> Protective conductor current

### Maximum Permissible Limit Values for Equivalent Leakage Current in mA

Test Standard	I <sub>EL</sub>
EN 50678 / DIN EN 50699	PC I: 3.5 1 mA/kW <sup>1</sup> PC II: 0.5

<sup>1</sup> For devices with heating power ≥ 3.5 kW

## 25.5 Bibliography

Statutory Source Documents		
German occupational safety legislation (BetrSichV) Regulations Issued by Accident Insurance Carriers		
Title	Information Rule/Regulation	Publisher
German ordinance on industrial safety and health (BetrSichV)	German occupational safety legislation	
Electrical systems and equipment	DGUV Regulation 3 (formerly BGV A3)	DGUV (formerly HVBG)

VDE Standards			
German Standard	Title	Date of Issue	Publisher
DIN VDE 0100-410	Protection against electric shock	2018-10	Beuth-Verlag GmbH
DIN VDE 0100-530	Low-voltage electrical installations Part 530: Selection and erection of electrical equipment, switchgear and control gear	2018-06	Beuth-Verlag GmbH
DIN VDE 0100-600 (IEC 60364-6)	Low-voltage electrical installations Part 6: Tests	2017-06	Beuth-Verlag GmbH
Series of standards DIN EN 61557	Devices for testing, measuring or monitoring protective measures		Beuth-Verlag GmbH
DIN VDE 0105-100 (EN 50110-1)	Operation of electrical installations, Part 100: General requirements	2015-10	Beuth-Verlag GmbH
VDE 0122-1 DIN EN 61851-1	Electric vehicle conductive charging system – Part 1: General requirements	2019-12 (supplementary sheet 2021-06)	Beuth-Verlag GmbH

## 25.6 Internet Addresses for Additional Information

Internet Address	
www.dguv.de	DGUV information, rules and regulations from German statutory accident insurance
www.beuth.de	VDE regulations, DIN standards, VDI directives from Beuth-Verlag GmbH
www.bgetem.de	BG information, rules and regulations from the trade associations, e.g. BG ETEM (trade association for energy, textiles and electrical medical devices)



---

Gossen Metrawatt GmbH  
Prepared in Germany • Subject to change, errors excepted • PDF version available on the Internet

All trademarks, registered trademarks, logos, product names and company names are the property of their respective owners.

 **GOSSEN METRAWATT**

Gossen Metrawatt GmbH  
Südwestpark 15  
90449 Nürnberg • Germany

Phone: +49 911 8602-111  
Fax: +49 911 8602-777  
e-mail: [info@gossenmetrawatt.com](mailto:info@gossenmetrawatt.com)  
[www.gossenmetrawatt.com](http://www.gossenmetrawatt.com)