

# METRALINE RCD<sup>CHECK</sup>

## RCD Test Instrument

3-349-694-03  
4/3.21



| Contents  | Page      |
|---|-----------|
| <b>1 Introduction</b> .....   | <b>2</b>  |
| 1.1 Scope of Delivery .....   | 2         |
| 1.2 Optional accessories .....  | 2         |
| 1.3 Safety Precautions .....  | 2         |
| 1.4 Applications .....  | 3         |
| 1.5 Applicable Standards .....  | 3         |
| 1.6 Environment .....   | 3         |
| <br>  |           |
| <b>2 Device Description</b> .....   | <b>3</b>  |
| 2.1 Housing .....   | 3         |
| 2.2 Operation and OLED Display .....  | 4         |
| 2.3 Initial Start-Up .....  | 4         |
| <br>  |           |
| <b>3 Performing Measurements</b> .....  | <b>4</b>  |
| 3.1 Switching the Instrument On and Off .....   | 4         |
| 3.2 Instructions and Principles with Validity for<br>All Measurements .....                                   | 4         |
| 3.3 Adjustable Parameters .....   | 5         |
| 3.4 Measuring the Individual Parameters of an RCD .....   | 6         |
| 3.4.1 Touch Voltage $U_c$ .....   | 6         |
| 3.4.2 Time to Trip – TIME .....   | 6         |
| 3.4.3 Tripping Current I .....  | 7         |
| 3.5 Further Device Functions .....  | 7         |
| 3.6 Device Reset Function .....   | 7         |
| <br>  |           |
| <b>4 Technical Data</b> .....   | <b>8</b>  |
| 4.1 Measuring Functions .....   | 8         |
| 4.2 General Data .....  | 8         |
| <br>  |           |
| <b>5 Maintenance</b> .....  | <b>9</b>  |
| 5.1 Device Power Supply .....   | 9         |
| 5.1.1 Inserting and Replacing the Batteries .....   | 9         |
| 5.1.2 Recharging the Batteries .....  | 9         |
| 5.1.3 Fuse Replacement .....  | 9         |
| 5.2 Cleaning .....  | 9         |
| 5.3 Recalibration .....   | 10        |
| <br>  |           |
| <b>6 Repair and Replacement Parts Service,<br/>Calibration Center and Rental<br/>Instrument Service</b> ..... | <b>10</b> |
| <br>  |           |
| <b>7 Product Support</b> .....  | <b>10</b> |

## 1 Introduction

### 1.1 Scope of Delivery

- 1 Test instrument with mobile test probe
- 4 Batteries (AAA)
  - 1 Pouch
  - 1 Condensed operating instructions
  - 1 CD ROM with operating instructions in available languages
  - 1 Factory calibration certificate

### 1.2 Optional accessories

- 4 ea. rechargeable AAA NiMH batteries (Z507B)
- 1 battery charger (Z507A)

## 1.3 Safety Precautions

**Read the operating instructions thoroughly and carefully before using your instrument. Follow all instructions contained therein. Make sure that the operating instructions are available to all users of the instrument.**

### Meanings of Symbols on the Instrument



This device is equipped with double or reinforced insulation.



Danger of injury due to electrical current, warning regarding dangerous electrical voltage



Warning concerning a source of danger (attention, observe documentation!)



Indicates European Conformity: This instrument fulfills all requirements of applicable European directives.

Before using the instrument, it must be assured that it is safe. Do not use if:

- Visible damage is apparent
- The battery compartment lid is missing
- The device has been stored under unfavorable conditions for a lengthy period of time
- The device has been handled impermissibly, e.g. has been dropped from a height of 1 meter or more
- The test instrument does not function as described in these operating instructions (if this is the case, we recommend resetting the device as described in section 3.6 on page 7)

### CAUTION

- Do not touch electrically conductive parts, test probes etc. when the device is switched on and voltage might still be conducted by a test probe – DANGER OF INJURY!
- Only use test probes which are included with the instrument or are available as accessories.
- The device must be switched off and no voltage may be applied when exchanging accessories.
- It is absolutely essential to adhere to all safety precautions, regulations and standards when performing measurements.
- No keys may be pressed when connecting the instrument to a device under test.
- The test instrument may not be subjected to the influence of aggressive substances, gases, vapors, liquids or dust.
- The test instrument may only be used under the conditions listed in the technical data in section 4 on page 8.
- If the device is moved from a colder to a warmer room, condensation may occur, in which case a brief period of acclimatization is advisable.
- We recommend removing the batteries during lengths periods of storage.
- Two relatively strong magnets are integrated into the test instrument. Avoid close proximity to magnetically sensitive objects such as watches, credit cards and the like.
- The illustrations in these operating instructions are drawings and may therefore deviate from reality.

## Exclusion of Liability

When testing systems with RCCBs, the latter may switch off. This may occur even though the test does not normally provide for it. Leakage currents may be present which, in combination with the test current of the test instrument, exceed the shutdown threshold value of the RCCB. PCs which are operated in proximity to such RCCB systems may switch off as a consequence. This may result in inadvertent loss of data. Before conducting the test, precautions should therefore be taken to ensure that all data and programs are adequately saved and the computer should be switched off, if necessary. The manufacturer of the test instrument assumes no liability for any direct or indirect damage to equipment, computers, peripheral equipment or data bases when performing the tests.



- Use original accessories only.
- Maximum permissible voltage between test probe and ground is 300 V!
- Maximum permissible (externally applied) voltage between the test probes is 600 V!

## Opening of Equipment / Repair

The equipment may be opened only by authorized service personnel to ensure the safe and correct operation of the equipment and to keep the warranty valid.

Even original spare parts may be installed only by authorized service personnel.

In case the equipment was opened by unauthorized personnel, no warranty regarding personal safety, measurement accuracy, conformity with applicable safety measures or any consequential damage is granted by the manufacturer.

## 1.4 Applications

The test instrument is enclosed in a compact housing with a patented means of retaining the test probes.

The high-contrast, four-color OLED display assures excellent legibility. When performing measurements under unfavorable light conditions, measuring point illumination can be switched on – white LED at the front.

The RCD test instrument is capable of the following measurements:

- RCD disconnection time
- RCD breaking current
- Touch voltage
- Loop impedance without tripping the RCD
- Phase detection

## 1.5 Applicable Standards

| Measurement | EMC              | Safety      |
|-------------|------------------|-------------|
| EN 61557-1  | EN 55022 class B | EN 61010-1  |
| EN 61557-6  | EN 61326-1       | EN61010-031 |

## 1.6 Environment

The shipping package is made of recyclable cardboard. Batteries must be disposed of in accordance with applicable regulations.



This device may not be disposed of with the trash. Further information regarding the WEEE mark can be accessed on the Internet at [www.gossenmetrawatt.com](http://www.gossenmetrawatt.com) by entering the search term "WEEE".

## 2 Device Description

### 2.1 Housing

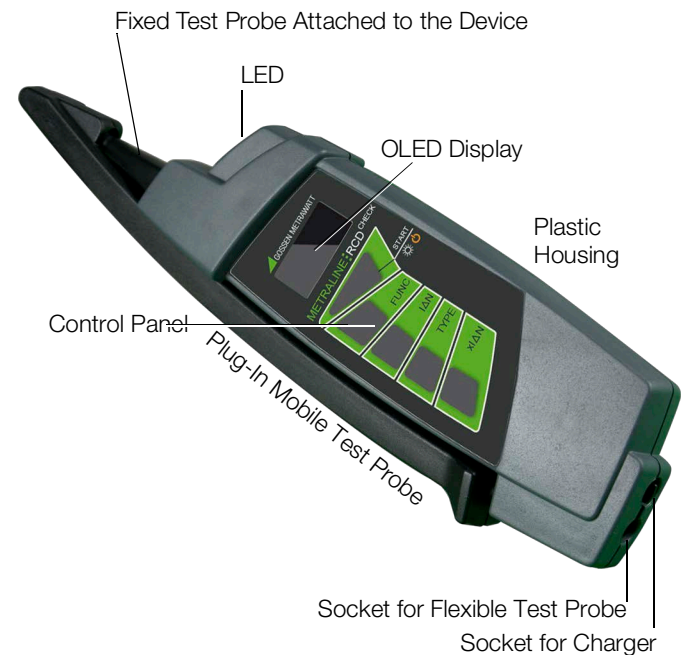

Figure 2.1: Top View

For transport purposes, the movable test probe can be attached to the housing and retained by a magnet such that both metal tips are simultaneously recessed and protected.

In order to charge batteries which have been inserted into the instrument, the flexible test probe's connector plug must be removed and the slide must be pushed to the left, so that the socket at the right is made accessible and the charger can be plugged into it.

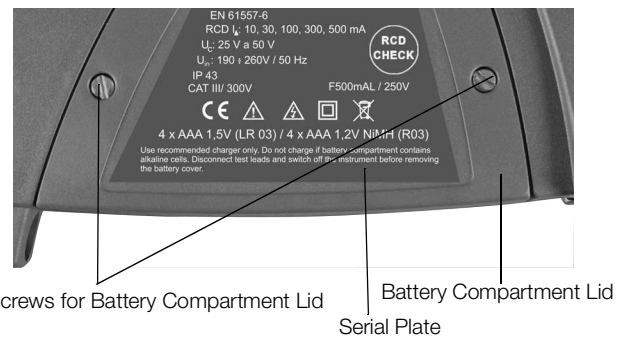

Figure 2.2: Detail View of the Back Panel with Battery Compartment Lid

## 2.2 Operation and OLED Display

1 Graphic OLED display

2 **START** key:

– **Switch on:**

Press and hold until the display lights up.

– **Start measurement:**

Press and hold until measurement starts. Briefly pressing starts measurement if voltage is applied to the test probes (exception for  $U_c$ : is displayed immediately after voltage is applied).

– **Measurement point illumination:**

Press briefly to switch illumination on and off.

– **Switch off:**

Press twice briefly to switch the instrument off.

3 **FUNC** key for selecting the following measuring functions:  $U_c$ , **TIME**,  $I$

4 **I $\Delta$ N** key for selecting nominal residual current

5 **TYPE** key:

–  **$U_c$  function:**

RCD Type Selection

– **TIME function:**

Selection of waveform and initial polarity of the residual current, as well as RCD type

– **I function**

Selection of waveform and initial polarity of the residual current

6 **xI $\Delta$ N** key

–  **$U_c$  function:**

Selection of the touch voltage limit value

– **TIME function:** selection of a multiplier for nom. residual current

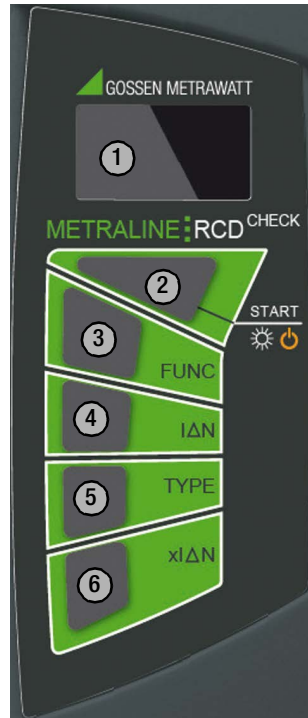

Figure 2.3: Control Panel and OLED Display

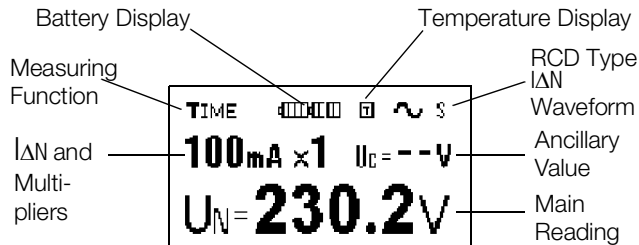

Figure 2.4: Example of Displayed Information

The information which appears at the display varies depending on the selected function.

## 2.3 Initial Start-Up

After inserting the batteries in accordance with section 5.1 on page 9, the measuring instrument is ready for operation.

## 3 Performing Measurements

### 3.1 Switching the Instrument On and Off

The instrument is switched on by pressing and holding the **START** key. Briefly press the **START** key twice in order to switch the instrument off, during which no voltage may be applied to the test probes! The instrument is switched to the standby mode after several seconds (reduced brightness), if none of the keys has been pressed and no voltage is applied to the test probes. The instrument is switched out of the standby mode (i.e. back to full brightness) by pressing any key or applying voltage to the test probes. The instrument is shutdown automatically if it has remained inactive for about 1 minute, i.e. if no keys have been pressed and no voltage has been applied to the test probes during this time.

## 3.2 Instructions and Principles with Validity for All Measurements

### Setting Parameters

The desired functions or parameters are selected with the **FUNC**, **I $\Delta$ N**, **TYPE** and **xI $\Delta$ N** keys (see section 3.3). Measurement is triggered by pressing the **START** key. All selected functions or parameters remain valid until they are changed.

### Interference Voltage

If (interference) voltage of less than 190 V or greater than 255 V is applied to the test probes, corresponding information appears at the display. If this is the case, the **START** key is disabled.

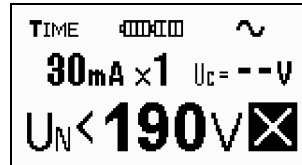

Figure 3.1: Display of (Interference) Voltage < 190 V

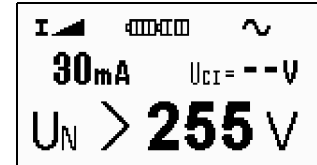

Figure 3.2: Display of (Interference) Voltage > 255 V

### Blown Fuse

If line voltage is applied to the test probes, and if the fuse is either blown or has not been inserted, this is indicated at the display.

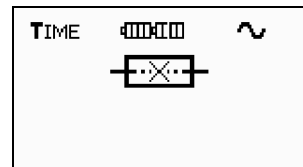

Figure 3.3: Blown Fuse Display

The fuse must be replaced as described in section 5.1.3.



### Note

If a voltage within a range of 25 to 190 V is applied to the test probes, the blown fuse symbol is also displayed at the instrument even if the fuse is OK. For this reason, make sure that voltage in the measured electrical circuit is really less than 190 V before replacing the fuse.

### Prerequisites for RCD Measurement

- If a voltage within a range of 190 to 255 V is applied to the test probes, the TRMS value appears at the display and measurement can be triggered by pressing the **START** key.

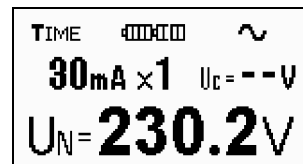

Figure 3.4: Example of a Voltage Measurement

- For safety reasons, the test instrument first determines whether or not touch voltage  $U_c$  is higher than the selected limit value each time the **START** key is pressed before measuring RCD parameters. If the limit value is exceeded, this is indicated at the display and the measurement is ended.

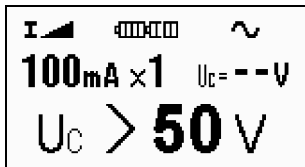

Figure 3.5: Touch Voltage > 50 V

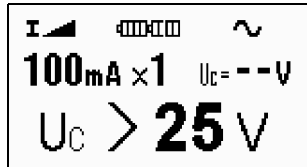

Figure 3.6: Touch Voltage > 25 V

### Tripping During Touch Voltage Measurement

If the display shown in figure 3.7 appears after pressing the **START** key, the RCD has been tripped during touch voltage measurement. This can be caused by an incorrectly adjusted nominal current value  $I_{\Delta N}$ , by a defective RCD or by previously existing leakage current via the RCD. This status is displayed until one of the function selection keys is pressed, or the device is once again connected to mains power.

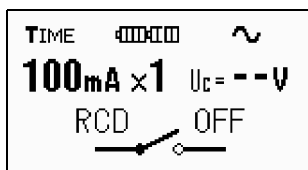

Figure 3.7: Example of Display for Tripping During Touch Voltage Measurement

### Low Battery Voltage

If battery voltage is too low (only the red field is lit up in the battery symbol), measurement cannot be triggered with the **START** key. If the key is nevertheless pressed, the depleted battery symbol is displayed for about 1 second. The instrument is then returned to its previous status. Replace the batteries with new ones or recharge them as described in section 5.1.

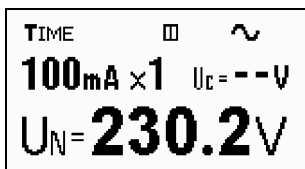

Figure 3.8: Battery Voltage Too Low



Figure 3.9: Battery Status After Pressing the **START** Key

### Overheating

If several measurements with high  $I_{\Delta N}$  values are performed one after the other, the red field indicates internal warming of the instrument. As temperature increases, the red field is gradually filled in and becomes wider. An inversely displayed **STOP** symbol appears when the maximum permissible temperature is exceeded. If the **START** key is pressed, the overheating symbol appears for about 1 second and further measurements are disabled. The instrument is then returned to its previous status which prevailed before the **START** key was pressed. Allow the test instrument to cool down, which is indicated by the shrinking temperature display.



Bild 3.10 STOP: Indication of Overheating



Figure 3.11: Indication of Overheating After Pressing the **START** Key

### Performing the Measurement

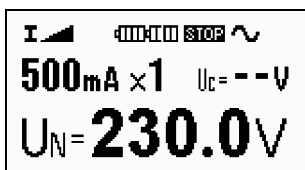
Securely contact the device under test with the test probes before triggering the measurement by pressing the **START** key. Afterwards, check to see whether or not the displayed line voltage value is stable. Do not remove the test probes from the device under test during measurement. Measurement results might otherwise be distorted.

### Influences on Measurement Results

- Current flowing via PE has an unfavorable influence on measurement results, or makes measurement entirely impossible, due to, for example, consuming devices or capacitance between L and PE. Consuming devices of this sort should therefore be removed prior to measurement.
- Measurement results can be influenced by several factors:
  - Leakage current in the measured electrical circuit
  - Interference voltage occurring in an earthing system
  - When the earthing system is influenced by the potential of another earthing system
  - Fluctuating line voltage

If the symbol shown at the right appears together with the measurement results, the measurement results for the respective function lie within the specified limit values.



### 3.3 Adjustable Parameters

- The **limit value for touch voltage  $U_{cmax}$**  can be set to either 50 V or 25 V. Adjust with the **xI $\Delta$ N** key when the touch voltage measurement function (Uc) has been activated with the **FUNC** key.
- The **nominal value for residual current** can be set to one of the following values with the **I $\Delta$ N** key: 10 mA, 30 mA, 100 mA, 300 mA or 500 mA.
- The **residual current multiplier** can be set to a value of ½, 1, 2 or 5 for 10, 30 and 100 mA, or to ½ or 1 for 300 and 500 mA with the **xI $\Delta$ N** key, after the **TIME** function has been activated with the **FUNC** key.
- **RCD type:** Residual current waveform and polarity are selected with the **TYPE** key.

| Display Symbol | RCD Type (residual current waveform) | Initial Polarity of the Residual Current |
|----------------|--------------------------------------|--|
| ~              | AC (sinusoidal)                      | Positive half-wave                       |
|                |                                      | Negative half-wave                       |
| A              | A (pulsed)                           | Positive half-wave                       |
|                |                                      | Negative half-wave                       |
| Display Symbol | RCD Type                             | RCD Type                                 |
| S              | AC or A                              | Standard                                 |
|                |                                      | Selective                                |

Refer to the technical data in section 4 for further details.

### 3.4 Measuring the Individual Parameters of an RCD

#### 3.4.1 Touch Voltage U<sub>c</sub>

The displayed touch voltage refers to nominal residual current. For safety reasons, it is multiplied by the following coefficients:

| RCD type | Contact voltage is proportional to:                 |
|----------|---|
|          | $1,05 \times I_{\Delta N}$                          |
|          | $1,05 \times 2 \times I_{\Delta N}$                 |
|          | $1,05 \times \sqrt{2} \times I_{\Delta N}$          |
|          | $1,05 \times 2 \times \sqrt{2} \times I_{\Delta N}$ |

- ⇨ Select the **U<sub>c</sub>** function with the **FUNC** key.
- ⇨ The nominal value for residual current can be set with the **I<sub>ΔN</sub>** key.
- ⇨ RCD type is selected with the **TYPE** key.
- ⇨ The limit value for touch voltage **U<sub>c</sub>** is adjusted with the **xI<sub>ΔN</sub>** key.

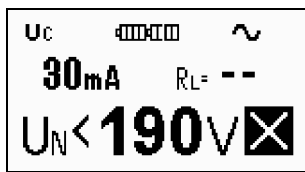

Figure 3.12: Example: Settings for Touch Voltage Measurement

- ⇨ Connect the instrument to L and PE downstream from the RCD as shown below. Example:

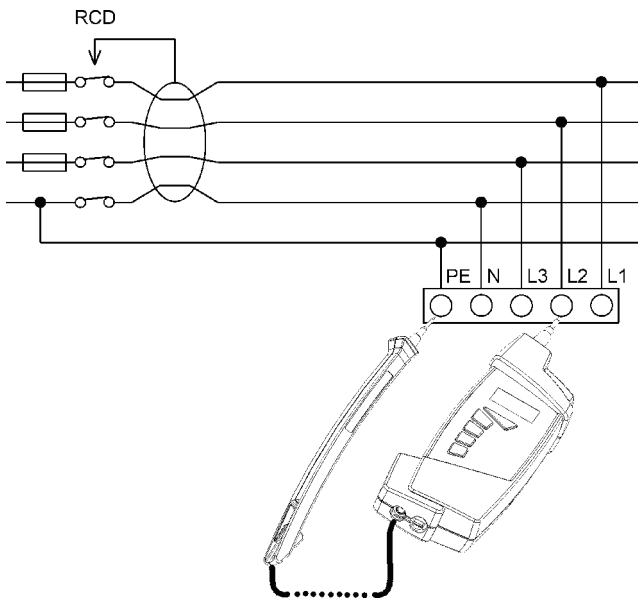

Figure 3.13: Connection Example

- ⇨ After voltage value  $U_{L-PE}$  settles in, briefly press the **START** key to trigger the measurement.

After the measurement has been completed, the results are displayed as follows:

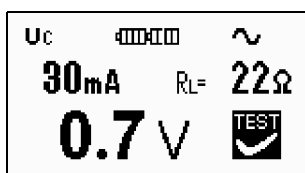

Figure 3.14: Results of a Touch Voltage Measurement

$R_L$  ... fault loop impedance;  $R_L = U_{c^*} / I_{\Delta N}$ , where  $U_{c^*}$  is actually measured touch voltage, i.e. without a safety coefficient from the table at the beginning of this section.



#### Note

The value for fault loop impedance appears at the display if residual current  $I_{\Delta N}$  is set to  $\geq 30$  mA.

- ⇨ Remove the test instrument from the RCD under test.

#### 3.4.2 Time to Trip – TIME

The following table shows time to trip in accordance with the EN 61008, EN 61009 and IEC 60364-4-41 standards:

|           | $\frac{1}{2} I_{\Delta N}^*$ | $I_{\Delta N}$ | $2 I_{\Delta N}$ | $5 I_{\Delta N}$ | Comment                           |
|-----------|------------------------------|----------------|------------------|------------------|-----------------------------------|
| Standard  | —                            | 300 ms         | 150 ms           | 40 ms            | max. permissible tripping current |
| Selective | —                            | 500 ms         | 200 ms           | 150 ms           |                                   |
|           | —                            | 130 ms         | 60 ms            | 50 ms            | min. permissible tripping current |

\* An RCD may not trip at  $\frac{1}{2} I_{\Delta N}$ .

- ⇨ Select the **TIME** function by pressing the **FUNC** key.
- ⇨ The nominal value for residual current can be set with the **I<sub>ΔN</sub>** key.
- ⇨ RCD type is selected with the **TYPE** key.
- ⇨ Select a multiplier with the help of the **xI<sub>ΔN</sub>** key.

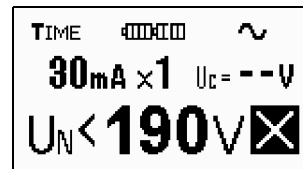

Figure 3.15: Example: Settings for Time to Trip Measurement

- ⇨ Connect the instrument to L and PE downstream from the RCD as shown in figure 3.13.
- ⇨ After voltage value  $U_{L-PE}$  settles in, briefly press the **START** key to trigger the measurement.

After the measurement has been completed, the results are displayed as follows:

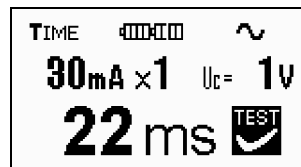

Figure 3.16: Results of the Time to Trip Measurement

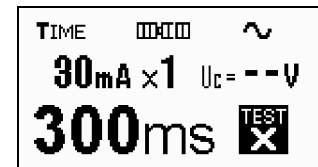

Figure 3.17: Results when the RCD is not Tripped

$U_c$  (touch voltage) ... touch voltage value

- ⇨ Remove the test instrument from the RCD under test.

**Comment:** Selective RCDs include a delay element which makes it necessary to wait for a certain amount of time after each measurement until the RCD is returned to its initial state. A 30 second pause is therefore specified for the measurement of selective RCDs, the progress of which appears at the display in the form of a countdown timer which runs from 30 seconds to 1 second:

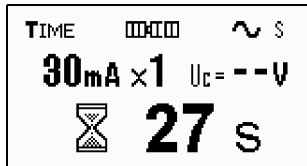

Figure 3.18: Example: Waiting Time for Measuring Selective RCDs

### 3.4.3 Tripping Current I

- ⇨ Select the I function by pressing the **FUNC** key.
- ⇨ Set residual current with the **IΔN** key.
- ⇨ RCD type is selected with the **TYPE** key.

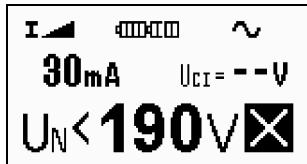

Figure 3.19: Settings for the Tripping Current Measurement

- ⇨ Connect the instrument to L and PE downstream from the RCD as shown in figure 3.13 section "Connection Example".
- ⇨ After voltage value  $U_{L-PE}$  settles in, briefly press the **START** key to trigger the measurement.

After the measurement has been completed, the results are displayed as follows:

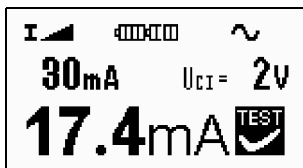

Figure 3.20: Tripping Current Measurement Results

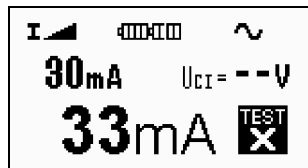

Figure 3.21: Example: RCD is Not Tripped

$U_c$  (touch voltage) ... touch voltage value

- ⇨ Remove the test instrument from the RCD under test.

## 3.5 Further Device Functions

### Phase Detection

If the symbol shown at the right appears in the lower right-hand corner of the display, and if a phase is contacted with the fixed test probe, the symbol is changed:



The other test probe may not be connected anywhere or make any contact at all!

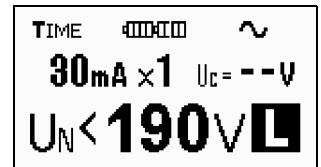
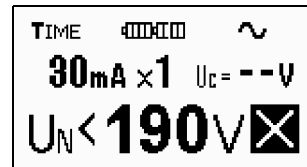

Figure 3.22: No Phase Voltage Figure 3.23: Phase Voltage

### Note

As usual, the test instrument must be gripped in the hand! Phase voltage to earth must be  $\geq 190$  V at 45 to 65 Hz – displayed results are otherwise not reliable.

### Querying the Firmware Version

Before querying the firmware version, disconnect both test probes from the device under test / measuring circuit, and switch the test instrument off.

- ⇨ Press and hold the **FUNC** key while switching the test instrument on by pressing and holding the **START** key.

The firmware version appears at the display.

- ⇨ The display is returned to the standard menu when the **FUNC** key is released.

## 3.6 Device Reset Function

If the test instrument does not function as described in these instructions, we recommend a device reset. The test instrument must be switched off and neither of the test probes may be connected to a DUT. If device functions are still incorrect after switching the instrument back on again, remove the batteries as described in section 5.1 on page 9, wait at least 10 seconds and then reinsert the batteries (or replace them with new ones).

If the test instrument still does not function as described, remove the batteries and contact our service department (see section 6).

## 4 Technical Data

### 4.1 Measuring Functions

#### Residual Current Devices (RCD) – General Specifications

Nom. residual current 10, 30, 100, 300, 500 mA

Deviation from nominal residual current  $(-0/+0.1)I_{\Delta N}$ ;  $I_{\Delta} = I_{\Delta N}, 2 \times I_{\Delta N}, 5 \times I_{\Delta N}$

Waveform of the nom. residual current Sinusoidal (AC), pulsating DC (A)

RCD type Standard and selective S

Initial polarity of the residual current  $0^\circ$  or  $180^\circ$

Voltage range 190 V to 255 V / 45 to 65 Hz

Residual Current Generated by the Tester (TRMS value at 20 ms):

| $I_{\Delta N}$<br>(mA) | $\frac{1}{2} I_{\Delta N}$ |      | $I_{\Delta N}$ |     | $2 \times I_{\Delta N}$ |     | $5 \times I_{\Delta N}$ |     | $I_{\Delta}$ |   |
|------------------------|----------------------------|------|----------------|-----|-------------------------|-----|-------------------------|-----|--------------|---|
|                        | AC                         | A    | AC             | A   | AC                      | A   | AC                      | A   | AC           | A |
| 10                     | 5                          | 3.5  | 10             | 20  | 20                      | 40  | 50                      | 100 | ✓            | ✓ |
| 30                     | 15                         | 10.5 | 30             | 42  | 60                      | 84  | 150                     | 212 | ✓            | ✓ |
| 100                    | 50                         | 35   | 100            | 141 | 200                     | 282 | 500                     | —   | ✓            | ✓ |
| 300                    | 150                        | 105  | 300            | 424 | —                       | —   | —                       | —   | ✓            | ✓ |
| 500                    | 250                        | 175  | 500            | —   | —                       | —   | —                       | —   | ✓            | — |

#### Touch Voltage $U_c$ and $U_{ci}$

Nominal range per EN 61557-6 – 3.0 to 49.0 V for a touch voltage limit value of 25 V

Nominal range per EN 61557-6 – 3.0 to 99.0 V for a touch voltage limit value of 50 V

| Measuring Range | Resolution | Intrinsic Uncertainty | Measuring Uncertainty |
|-----------------|------------|-----------------------|-----------------------|
| 0.0 to 9.9 V    | 0.1 V      | -0/+10% rdg. + 2 D    | -0/+10% rdg. + 3 D    |
| 10.0 to 99.9 V  |            | -0/+10% rdg.          | -0/+10% rdg. + 1 D    |

#### Impedance of the Fault Loop $R_L$

Nominal range per EN 61557-3 – 27  $\Omega$  to 2000  $\Omega$

| Measuring Range    | Resolution | Intrinsic Uncertainty              | Measuring Uncertainty              |
|--------------------|------------|------------------------------------|------------------------------------|
| 0 to 2000 $\Omega$ | 1 $\Omega$ | (5%rdg.+3D+0.05V/ $I_{\Delta N}$ ) | (5%rdg.+5D+0.05V/ $I_{\Delta N}$ ) |

Measuring current:  $\leq \frac{1}{2} I_{\Delta N}$

The results of the fault loop impedance measurement appear at the display if nominal residual current is set to  $I_{\Delta N} \geq 30$  mA.

#### Time to Trip – TIME

Standard Residual Current Circuit Breaker (range per EN 61557-6):

| Measuring Range  | Resolution | Intrinsic Uncertainty | Measuring Uncertainty |
|--|------------|-----------------------|-----------------------|
| 0 to 300 ms<br>( $\frac{1}{2}I_{\Delta N}, I_{\Delta N}$ ) | 1 ms       | $\pm 3$ ms            | $\pm 4$ ms            |
| 0 to 150 ms<br>( $2 \times I_{\Delta N}$ )                 |            |                       |                       |
| 0 to 40 ms<br>( $5 \times I_{\Delta N}$ )                  |            |                       |                       |

Selective Residual Current Circuit Breaker (range per EN 61557-6):

| Measuring Range   | Resolution | Intrinsic Uncertainty | Measuring Uncertainty |
|---|------------|-----------------------|-----------------------|
| 0 ... 500 ms<br>( $\frac{1}{2}I_{\Delta N}, I_{\Delta N}$ ) | 1 ms       | $\pm 3$ ms            | $\pm 4$ ms            |
| 0 ... 200 ms<br>( $2 \times I_{\Delta N}$ )                 |            |                       |                       |
| 0 ... 150 ms<br>( $5 \times I_{\Delta N}$ )                 |            |                       |                       |

#### Tripping Current $I_{\Delta}$

Range per EN 61557-6

| Measuring Range for $I_{\Delta}$        | Resolution | Intrinsic Uncertainty   | Measuring Uncertainty  |
|---|------------|-------------------------|------------------------|
| 0.4 to 1.1 $I_{\Delta N}$<br>(type: AC) | 0.1 mA     | $\pm 0.08 I_{\Delta N}$ | $\pm 0.1 I_{\Delta N}$ |
| 0.4 to 1.5 $I_{\Delta N}$<br>(type: A)  |            |                         |                        |

#### Alternating Voltage (frequency range: 45 to 65 Hz)

| Measuring Range | Resolution | Intrinsic Uncertainty                 | Measuring Uncertainty                 |
|-----------------|------------|---------------------------------------|---------------------------------------|
| 190 to 255 V    | 0.1 V      | $\pm(2\% \text{ rdg.} + 2 \text{ D})$ | $\pm(3\% \text{ rdg.} + 3 \text{ D})$ |

#### Key

- In the case of alternating quantities, the TRMS voltage value is measured.
- The measuring uncertainties specified here are only valid if line voltage is stable during measurement, the earthing system is free of interference voltage, there are no influences caused by potential from neighboring systems and no leakage current flows through the measured electrical circuit.
- rdg. means reading, i.e. measured value, D = digits (i.e. number of the decimal place with the least significance)

### 4.2 General Data

#### Reference Conditions

Temperature  $23 \pm 2^\circ \text{C}$   
Relative humidity 40 to 60%  
Device position any

#### Ambient Conditions

##### Operating Conditions

Operating temperature  $0$  to  $40^\circ \text{C}$   
Relative Humidity max. 85%, no condensation allowed  
Device position any

##### Storage Conditions

Temperature  $-10$  to  $70^\circ \text{C}$   
Relative Humidity max. 90% at  $-10$  to  $+40^\circ \text{C}$   
max. 80% at  $+40$  to  $+70^\circ \text{C}$

Device position any

#### Power Supply

Batteries 4 ea. AAA (LR03), 1.5 V alkaline or 1.2 V NIMH (with at least 750 mAh)

Number of measurements with batteries at 800 mAh:  
approx. 3,000 measurements

#### Electrical Safety

Measuring category with safety cap applied to measuring probe: CAT III 300 V  
without safety cap applied to measuring probe: CAT II 300 V

Pollution degree 2

Protection class II

Fuse SIBA ceramic fuse  
6.3 mm x 32 mm, F1 A/600 V  
switching capacity 50 kA at 600 V

#### Mechanical Design

Display OLED, multicolored, graphic  
Protection IP 43  
Dimensions approx. 260 x 70 x 40 mm  
Weight approx. 0.36 kg with batteries



## 5 Maintenance

### 5.1 Device Power Supply



#### Caution: Dangerous Voltage!

Dangerous voltage in battery compartment!

#### Before Opening the Battery Compartment Lid

Remove the test probes from the device under test and switch the instrument off before opening the battery compartment lid.

#### Operate Only With Inserted Battery Compartment Lid

The instrument may not be placed into service if the battery compartment lid has not been inserted and secured with the screws.

Either alkaline batteries or rechargeable NiCD/NiMH batteries may be used to supply the instrument with electrical power (4 each, size: AAA, type: LR03).

The battery charge level is continuously displayed (see section 3.2).

If too little voltage is indicated, replace the batteries.



#### Note

We recommend removing the batteries during lengthy periods of non-use (e.g. vacation). This prevents excessive battery depletion or leakage, which may result in damage to the instrument under unfavorable conditions.

#### 5.1.1 Inserting and Replacing the Batteries

Loosen the two screws for the battery compartment lid at the back of the instrument and remove the lid. Insert the batteries. Assure correct battery polarity (refer to the embossed symbols at the bottom of the battery compartment).



Figure 5: Correct Battery Polarity

Always replace all four batteries at once, and use high quality batteries. Replace the battery compartment lid and retighten the screws.

### 5.1.2 Recharging the Batteries



#### Attention!

Use only the charger (Z507A) which is offered as an optional accessory for this instrument to charge the **batteries** inserted in the instrument.

**Make sure that the following conditions have been fulfilled before connecting the charger to the charging socket:**

- rechargeable batteries have been inserted with correct polarity, **no** normal batteries
- The test instrument has been disconnected from the measuring circuit at all poles
- The instrument must remain off during charging.

Recharging of the batteries begins as soon as the charger is connected to the mains and to the charging socket (see figure 2.1). Charging takes approximately 5 hours and 30 minutes (integrated safety timer) if the batteries have been fully depleted.

#### Safety Precautions

- Do not attempt to recharge alkaline batteries: they may leak, explode etc. The test instrument may be severely damaged or destroyed as a result.
- After initially charging new batteries and after rechargeable batteries have not been used for a lengthy period of time (several months), operating hours after charging may be significantly less than usual. If this is the case, repeat the charging procedure several times.  
Autonomous, intelligent charging stations execute charging/discharging cycles of this sort automatically (see instructions included with the charging station). This procedure increases the capacity of the batteries, thus making longer periods of operation possible between charging cycles.
- If no improvement is achieved in this way, one or more of the rechargeable batteries may no longer fulfill the original specifications. If this is the case, the defective rechargeable battery should be identified, e.g. with the help of the voltage measurement, and replaced.
- Battery capacity is gradually reduced as a result of long and frequent use. When you notice that this is the case, all of the rechargeable batteries should be replaced.

### 5.1.3 Fuse Replacement



#### Attention!

The fuse may only be replaced with the fuse type specified in section "Technical Data":

If any fuse other than the one specified is inserted into the instrument, this may result in damage to the instrument and/or danger for the user!

The fuse is in the battery compartment.

- ⇒ Loosen the two screws for the battery compartment lid and remove the lid. Remove the blown fuse from the fuse holder and replace it with a new one. Replace the lid and retighten the screws. Check the instrument for correct functioning!

### 5.2 Cleaning

Use a soft cloth and soapy water for cleaning. Do not place the test instrument back into service until its surface is completely dry.



#### Attention!

Do not use cleaning agents which contain benzene or alcohol! Prevent liquids from penetrating into the test instrument's interior.

### 5.3 Recalibration

The measuring tasks performed with your instrument, and the stressing it's subjected to, influence aging of its components and may result in deviation from the specified levels of accuracy.

In the case of strict measuring accuracy requirements, as well as in the event of use at construction sites with frequent stress due to transport and considerable temperature fluctuation, we recommend a relatively short calibration interval of once per year. If your instrument is used primarily in the laboratory and indoors without considerable climatic or mechanical stressing, a calibration interval of once every 2 to 3 years is sufficient as a rule.

During recalibration at an accredited calibration laboratory (DIN EN ISO/IEC 17025), deviations from traceable standards demonstrated by your measuring instrument are documented. Ascertained deviations are used to correct display values during later use of the instrument.

We would be happy to perform DAkkS or factory calibration for you at our calibration laboratory. Further information is available at our website:

[www.gossenmetrawatt.com](http://www.gossenmetrawatt.com) (→ COMPANY → Quality and Certificates → DAkkS-Calibration Center).

Recalibration of your instrument at regular intervals is essential for the fulfillment of requirements according to quality management systems per DIN EN ISO 9001.

\* Examination of the specification, as well as adjustment, are not included in calibration. However, in the case of our own products, any required adjustment is performed and adherence to the specification is confirmed.

## 6 Repair and Replacement Parts Service, Calibration Center and Rental Instrument Service

If required please contact:

GMC-I Service GmbH  
**Service Center**  
Beuthener Str. 41  
90471 Nürnberg, Germany  
Phone: +49 911 817718-0  
Fax: +49 911 817718-253  
E-mail [service@gossenmetrawatt.com](mailto:service@gossenmetrawatt.com)  
[www.gmci-service.com](http://www.gmci-service.com)

This address is only valid in Germany. Please contact our representatives or subsidiaries for service in other countries.

## 7 Product Support

If required please contact:

Gossen Metrawatt GmbH  
**Product Support Hotline**  
Phone: +49-911-8602-0  
Fax: +49 911 8602-709  
E-mail [support@gossenmetrawatt.com](mailto:support@gossenmetrawatt.com)

---

© Gossen Metrawatt GmbH

Prepared in Germany • Subject to change without notice / Errors excepted • A pdf version is available on the Internet

All trademarks, registered trademarks, logos, product designations, and company names are the property of their respective owners.

 **GOSSEN METRAWATT**  
Gossen Metrawatt GmbH  
Südwestpark 15  
90449 Nürnberg • Germany

Phone +49 911 8602-111  
Fax +49 911 8602-777  
E-Mail [info@gossenmetrawatt.com](mailto:info@gossenmetrawatt.com)  
[www.gossenmetrawatt.com](http://www.gossenmetrawatt.com)