

METRACLIP EARTH PE

Earthing Clamp Meter

3-447-105-03

1/7.21



Table of Contents

1 Safety Instructions	1
2 Applications	2
2.1 Intended Use / Use for Intended Purpose.....	2
2.2 Use for Other than Intended Purpose	2
2.3 Liability and Guarantee.....	2
2.4 Opening the Instrument / Repairs.....	2
3 Documentation	2
4 Getting Started	3
5 The Instrument	3
5.1 Scope of Delivery	3
5.2 Instrument Overview	3
5.3 Relevant Standards.....	5
5.4 Technical Data	5
5.5 Characteristic Values.....	6
6 Initial Startup	8
6.1 Establishing Power Supply (batteries / rechargeable batteries)	8
6.2 Switching the Instrument On and Off.....	9
6.3 Setting Date and Time.....	9
7 Instrument Settings	10
7.1 Alarms	10
7.2 Acoustic Signals.....	11
7.3 Automatic Freezing of the Measured Value (PRE-HOLD function).....	11
7.4 Clearing Memory.....	11
7.5 Automatic Standby Mode.....	12
7.6 Setting Date and Time.....	12
7.7 Querying Instrument Information	13
8 Operation	14
8.1 General Information on Measurements	14
8.2 Freezing the Measured Value (HOLD).....	14
8.3 Saving Measured Values	15
8.4 Impedance and Leakage Current Measurements (Ω + A)	15
8.5 Current Measurement (A)	16
8.6 Viewing Measured Values (measured value memory).....	16
8.7 Readjustment.....	16
9 Troubleshooting	19
10 Maintenance	20
11 Service and Support	20
11.1 Product Support	20
11.2 Repair and Replacement Parts Service Calibration Center * and Rental Instrument Service.....	20
12 CE Declaration	21
13 Returns and Environmentally Sound Disposal	21

1 Safety Instructions

- Observe this documentation, in particular all included safety information, in order to protect yourself and others from injury, and to prevent damage to the instrument.
- Carefully and completely read and adhere to these operating instructions.
The respective document can be found at <http://www.gossenmetrawatt.com>. Retain the document for future reference.
- Observe and comply with all safety regulations which are applicable for your work environment.
- Wear suitable and appropriate personal protective equipment (PPE) whenever working with the instrument.
- Use only the specified accessories (included in the scope of delivery or listed as options) with the instrument.
- Use the instrument in undamaged condition only.
Inspect the instrument before use. Pay particular attention to damage and interrupted insulation.
- If the instrument doesn't function flawlessly, permanently remove it from operation and secure it against inadvertent use.
- If the instrument is damaged during use, for example if it's dropped, remove it from operation permanently and secure it against inadvertent use.
- Do not use the instrument after extraordinary stressing due to transport.
- The instrument must not be exposed to direct sunlight.
- Only use the instrument within the limits of the specified technical data and conditions (ambient conditions, IP protection code, measuring category etc.).
- The instrument may only be used for the tests/measurements described in the documentation for the instrument.
- Live conductors must be at least 10 cm away from the instrument during impedance and leakage current measurements.
- Magnets must be at least 10 cm away from the instrument when performing measurements.
- Maintain a signal frequency of 47 to 800 Hz during current measurements. The clamp meter heats up dangerously at over 20 A and 800 Hz.
- The clamp meter may only be gripped up to the finger guard.
- Keep the opening gap and the measuring head's iron core impeccably clean. Even the slightest contamination can cause the clamp meter to malfunction.
- Do not use the instrument if the battery compartment cover has been removed.
Touch contact with dangerous voltage is otherwise possible.
- Always create a backup copy of your measurement data.

2 Applications

Please read this important information!

2.1 Intended Use / Use for Intended Purpose

The METRACLIP EARTH PE is an earthing clamp meter.

It's used to measure loop impedance in parallel connected earthing systems. It measures impedance (0.01 to 1200 Ω) with a fixed test signal frequency of 2083 Hz, as well as leakage current. And thus it can be used to check all types of earth loops.

Furthermore, the METRACLIP EARTH PE can be used as a normal current clamp transformer in order to measure current (0.5 mA to 20 A), e.g. for leakage current measurements.

The measured value memory function makes it possible to store measurements and display them later.

The clamp meter can be balanced with the help of the readjustment function without sending it to the manufacturer.

Safety of the operator, as well as that of the instrument, is only assured when it's used for its intended purpose.

2.2 Use for Other than Intended Purpose

Using the instrument for any purposes other than those described in these instrument operating instructions is contrary to use for intended purpose.

2.3 Liability and Guarantee

Gossen Metrawatt GmbH assumes no liability for property damage, personal injury or consequential damage resulting from improper or incorrect use of the product, in particular due to failure to observe the product documentation. Furthermore, all guarantee claims are rendered null and void in such cases.

Nor does Gossen Metrawatt GmbH accept any liability for data loss.

2.4 Opening the Instrument / Repairs



The instrument may only be opened by authorized, trained personnel in order to ensure flawless, safe operation and to assure that the guarantee isn't rendered null and void. Even original replacement parts may only be installed by authorized, trained personnel.

Unauthorized modification of the instrument is prohibited.

If it can be ascertained that the instrument has been opened by unauthorized personnel, no guarantee claims can be honored by the manufacturer with regard to personal safety, measuring accuracy, compliance with applicable safety measures or any consequential damages.

3 Documentation

The following identifiers are used in this documentation:

Identifier	Meaning
 Attention! Warning	Safety information that must be complied with
 Note! Important	Important information which must be taken into consideration and complied with
✓ Prerequisite	A condition etc. which must be fulfilled before a given action can be taken
1. Procedural step	Steps of a procedure which must be completed in the specified order
↳ Result	Result of a procedural step
• Enumeration	Bullet lists
– Enumeration	
Bild 1: Caption	Description of the content of a figure
Table 1:	Description of the content of a table
Footnote	Comment

4 Getting Started

1. Read and adhere to the product documentation. In particular observe all safety information in this documentation, on the instrument and on the packaging.
 - ⇒ “Safety Instructions” 1
 - ⇒ “Applications” 2
 - ⇒ “Documentation” 2
2. Familiarize yourself with the instrument ⇒ “The Instrument” 3.
3. Start up the instrument ⇒ “Initial Startup” 8.
4. Enter basic settings to the instrument ⇒ “Instrument Settings” 10.
5. Perform measurements, save and view measured values ⇒ “Operation” 14.

5 The Instrument

5.1 Scope of Delivery

Please check for completeness.

- 1 METRACLIP EARTH PE (M312P) (earth clamp meter with carrying strap)
- 4 1.5 volt batteries
- 1 Carrying case (lockable, with 2 keys)
- 1 Test certificate for the instrument (in English only)
- 1 Calibration loop (including test certificate in English)
- 1 Operating instructions (this document)

5.2 Instrument Overview

5.2.1 Controls



Bild 2: Instrument Overview

Rotary Selector Switch

Position	Function
SET-UP	Setup menu ⇒ “Instrument Settings” 10
MR	Access measured value memory (memory recall) ⇒ “Viewing Measured Values (measured value memory)” 16
A	Current measurement ⇒ “Operation” 14
A + Ω	Impedance and leakage current measurement ⇒ “Operation” 14





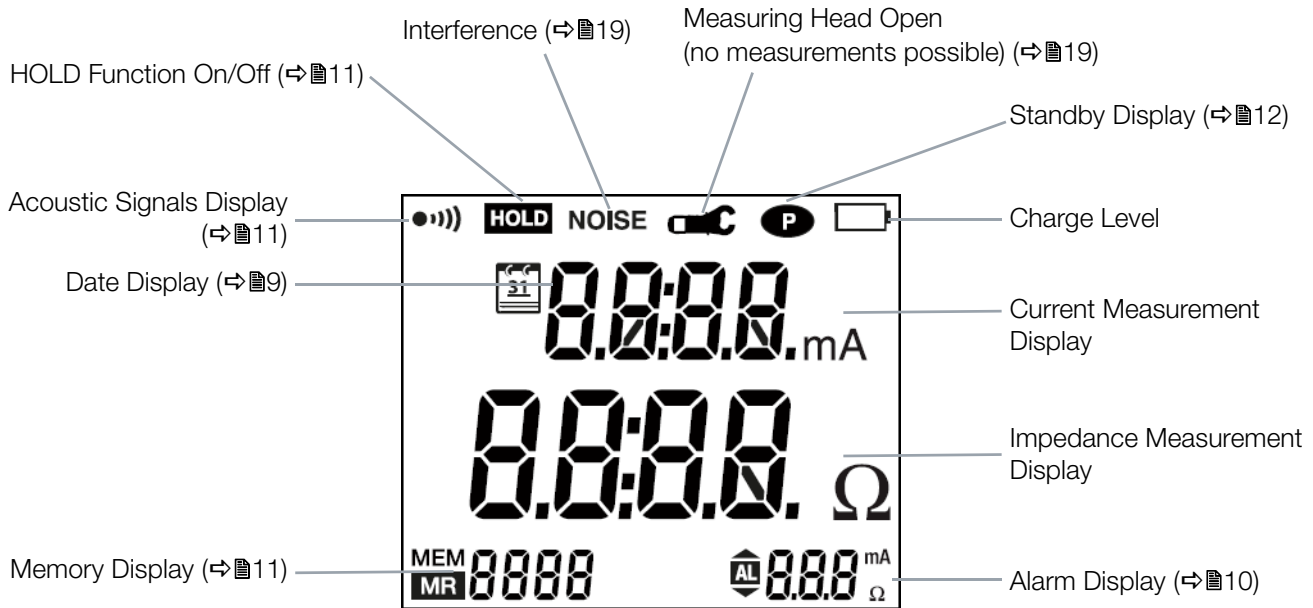

Function Keys

Key	Function
	Switch display illumination on and off
MEM	Store measured value
HOLD	Freezes the measured value and releases it again
▲ ▼	Navigate within the device configuration and during memory readout, change selected value
▶	Rotary switch in $\Omega + A$ or A position: Press and hold to switch buzzer on and off. Rotary switch in SET-UP position: Navigation in menus and confirmation of changes. Rotary switch in MR position: Switch between measurement and date/time display.

5.2.2 Display



5.2.3 Symbols on the Instrument and the Included Accessories

-  Warning concerning a point of danger (attention, observe documentation!)
-  Attachment or removal permitted on bare conductors with dangerous voltage. Type A current probe per IEC 61010 2 032
-  Double insulation (protection category II)
-  Batteries
-  European conformity marking
-  The tester may not be disposed of with household trash ⇒ "Returns and Environmentally Sound Disposal" 21.
-  A lifecycle analysis of the product according to ISO 14040 reveals that the product can be classified as recyclable.

5.3 Relevant Standards

The tester has been manufactured and tested in accordance with the following safety regulations:

EN 61010-1	Safety requirements for electrical equipment for measurement, control and laboratory use – General requirements
EN 61010-2-032	Safety requirements for electrical equipment for measurement, control and laboratory use – Part 2-032: Particular requirements for hand-held and hand-manipulated current sensors for electrical test and measurement
EN 60529	Test instruments and test procedures Degrees of protection provided by enclosures (IP code)
EN 61326-1	Electrical equipment for measurement, control and laboratory use – EMC requirements – Part 1: General requirements
EN 61326-2-2	Electrical equipment for measurement, control and laboratory use – EMC requirements – Part 2-2: Particular requirements – Test configurations, operational conditions and performance criteria for portable test, measuring and monitoring equipment used in low-voltage distribution systems

5.4 Technical Data

Power Supply	Supply:	Four 1.5 V alkaline batteries, type LR6 or AA, alternative: four rechargeable NiMH batteries
	Supply voltage:	5.8 ... 6.2 V
	Battery service life:	Approx. 20 hours, i.e. 2400 measurements lasting 30 seconds each
	Automatic shutdown:	On/off
Ambient Conditions	Operating temperature:	-20 ... +55 °C
	Storage temperature:	-30 ... +70 °C (without batteries)
	Relative atmospheric humidity:	Max. 75%, no condensation allowed
	Elevation:	Max. 2000 m
Electrical Safety	Measuring category:	100 V CAT IV, 150 V CAT III
	Pollution degree:	2
	Protection category:	II (per EN 61140)
Electromagnetic Compatibility (EMC)	Electrical field strength:	< 1 V/m
	Magnetic field strength:	< 40 A/m
	Interference emission:	EN 61326-1
	Interference immunity:	EN 61326-1
Mechanical Design	Operating position:	Horizontal clamp
	Conductor position in measuring head:	Centered
	Protection:	Housing: IP40 per EN 60529 (protection against ingress of solid foreign objects: ≥ 1.0 mm dia., protection against ingress of water: not protected)
	Housing (W × H × D):	Approx. 300 × 106 × 56 mm
	Clamp (enclosing diameter):	Square: 30 × 40 mm Rectangular: 20 × 55 mm Round: 32 mm
	Weight:	Approx. 1.2 kg (including batteries)
	Display:	OLED with 152 segments (active area: 48 × 39 mm)
Signals	Alarms:	For Z and I (optical, optionally acoustic)
	Acoustic signals:	Keys, alarms
Internal Memory	300 measured values with timestamp	
	Freeze function (manual or automatic HOLD)	

5.5 Characteristic Values

5.5.1 Measurements in General

Distortion factor	< 0.5%
Frequency	50 Hz, sinusoidal signal

5.5.2 Impedance and Leakage Current Measurement

Current during impedance measurement:	0 mA
Series inductance with resistor:	0 H

Reference Range

Measuring Ranges	0.010 ... 0.099 Ω	0.10 ... 0.99 Ω	1 ... 49.9 Ω	50 ... 149 Ω	150 ... 245 Ω	250 ... 440 Ω	450 ... 640 Ω	650 ... 1200 Ω
Resolution (R)	1 mΩ	10 mΩ	100 mΩ	1 Ω	5 mΩ	10 Ω	10 Ω	50 Ω
Intrinsic Uncertainty (δ)	± (1.5% R + 0.01 Ω)	± (1.5% R + 2 r)	± (1.5% R + 2 r)	± (2.5% R + 2 r)	± (5% R + 2 r)	± (10% R + 2 r)	± (15% R + 2 r)	± (20% R + 2 r)
Open-Circuit Voltage	≤ 4.5 mV at 2083 Hz							

Reference conditions: 20 ... 26 °C, at 40 ... 60% relative humidity (no condensation)

Intrinsic uncertainty is expressed as a percentage of the reading (R) and in display data points / resolution (r): (x% R + y r). It indicates deviation under reference conditions (see above).

Fluctuations within the Operating Range

Influencing Quantity	Operating Range	Influence				
		Typical		Maximum		
Temperature	-20 to + 55 °C	0.5 δ / 10 °C ± R		1.5 δ / 10 °C + R		
Relative humidity	10 to 75% relative humidity	1 δ ± R		2 δ ± R		
Supply voltage	4 to 6.5 V	0.05 δ ± R		0.1 δ ± R		
Conductor position	From edge to middle	Z < 450 Ω 0.2 δ ± R	Z ≥ 450 Ω 0.5 δ ± R	Z < 450 Ω 0.4 δ ± R	Z ≥ 450 Ω 1 δ ± R	
Clamp setting	± 180°	Z < 450 Ω 0.25 δ ± R	Z ≥ 450 Ω 0.5 δ ± R	Z < 450 Ω 0.5 δ ± R	Z ≥ 450 Ω 1 δ ± R	
Distance to magnets	Steel sheet metal, 1 mm at opening gap	0.1 δ ± R		0.5 δ ± R		
Magnetic field strength 50/60 Hz	30 A/m	0.05 δ ± R		0.1 δ ± R		
Neighboring conductor	I < 40 A	Z < 250 Ω 0.25 δ ± R	Z ≥ 250 Ω 0.4 δ ± R	Z < 250 Ω 0.5 δ ± R	Z ≥ 250 Ω 0.8 δ ± R	
Leakage current in the loop, 50 to 60 Hz, I < 10 A, Z × I < 75 V	Z < 100 Ω	Z × I < 20 V	0.5 δ ± R		1 δ ± R	
		20 V ≤ Z × I < 40	1 δ ± R		3 δ ± R	
		40 V ≤ Z × I	2 δ ± R		4 δ ± R	
	Z ≥ 100 Ω	0.5 δ ± R		1 δ ± R		
Loop inductance	0 to 500 μH	The instrument displays Z at measuring frequency (2083 Hz)				

Z = impedance I = current δ = intrinsic uncertainty (see above) R = resolution (see above)

5.5.3 Current Measurement

Signal Frequency	47 ... 800 Hz
------------------	---------------

Reference Range

Measuring Ranges	0.5 to 9.995 mA	10.00 to 99.90 mA	100.0 to 299.0 mA	0.300 to 2.990 A	3.00 to 20.00 A
Resolution (R)	50 μ A	100 μ A	1 mA	10 mA	100 mA
Intrinsic Uncertainty (δ)	$\pm (2\% R + 200 \mu\text{A})$	$\pm (2\% R + r)$	$\pm (2\% R + r)$	$\pm (2\% R + r)$	$\pm (2\% R + r)$

Reference conditions: 20 ... 26 °C, at 40 ... 60% relative humidity (no condensation)

Intrinsic uncertainty is expressed as a percentage of the reading (R) and in display data points / resolution (r): ($x\% R + y r$). It indicates deviation under reference conditions (see above).

Fluctuations within the Operating Range

Influencing Quantity	Operating Range	Influence	
		Typical	Maximum
Temperature	- 20 to + 55 °C	0.5 δ / 10 °C \pm R	1.5 δ / 10 °C + R
Relative humidity	10 to 75% relative humidity	0.5 $\delta \pm$ R	1 $\delta \pm$ R
Supply voltage	4 to 6.5V	0.05 $\delta \pm$ R	0.1 $\delta \pm$ R
Conductor position	From edge to middle	0.05 $\delta \pm$ R	0.2 $\delta \pm$ R
Clamp setting	$\pm 180^\circ$	0.1 $\delta \pm$ R	0.25 $\delta \pm$ R
Distance to magnets	Steel sheet metal, 1 mm at opening gap	0.1 $\delta \pm$ R	0.2 $\delta \pm$ R
Magnetic field strength 50/60 Hz	10 A/m	0.75 mA	1.5 mA
	30 A/m	2 mA	4.5 mA
	100 A/m	8 mA	15 mA
Leakage current offset	IEC 61557-13 5% at 50 Hz and 0° 6% at 250 Hz and 180° 5% at 350 Hz and 0°	0.05 $\delta \pm$ R	0.1 $\delta \pm$ R
Neighboring conductor	$I < 40$ A	> 70 dB	> 66 dB
Leakage current frequency	47 to 800 Hz ¹ (for the entire current measuring range)	0.5 $\delta \pm$ R	1 $\delta \pm$ R

Z = impedance I = current

δ = intrinsic uncertainty (see above)

R = resolution (see above)

6 Initial Startup

6.1 Establishing Power Supply (batteries / rechargeable batteries)

The instrument is powered by four 1.5 V type LR06 or AA alkaline batteries. Four NiMH rechargeable batteries can be used as an alternative.

Attention!

Leaky batteries may damage the instrument. Check the batteries at short, regular intervals and after long periods of storage.

Inserting or Replacing Batteries / Rechargeable Batteries

4 batteries are included with the instrument, which can be used when starting up it up for the first time. The batteries will need to be replaced at some point during use of the instrument (⇒ “Charge Level Indicator” 8). They can be replaced with either normal or rechargeable batteries. You’ll have to provide the necessary replacement batteries yourself.

Required tools: Phillips screwdriver.

Attention!



Use only the included batteries or batteries specified in the technical data (⇒ 5).

Attention!

Insert either 4 batteries or 4 rechargeable batteries. Do not mix batteries and rechargeable batteries!

Note!

Date and time are retained in memory for a few minutes, providing you with enough time to change the batteries. The instrument prompts you to set date and time (⇒ 9) during initial startup and after lengthy periods of time.



- ✓ The instrument is not connected to any other device (e.g. device under test).
 - ✓ The instrument is switched off ⇒ “Switching the Instrument On and Off” 9.
 - ✓ Suitable batteries or rechargeable batteries are available.
1. Place the instrument face down on a stable surface.
 2. Loosen the 2 captive screws for the battery compartment (the screws remain in the battery compartment cover).
 3. Remove the battery compartment cover.
 4. Optional: Remove previously inserted batteries.
 5. Insert new batteries into the battery compartment, making sure that the plus and minus poles match up with the provided polarity symbols.
 6. Replace the battery compartment cover. Make sure that it closes properly.
 7. Retighten the 2 captive screws
- ↳ The batteries have now been inserted. The instrument can be switched on ⇒ 9.

Note!

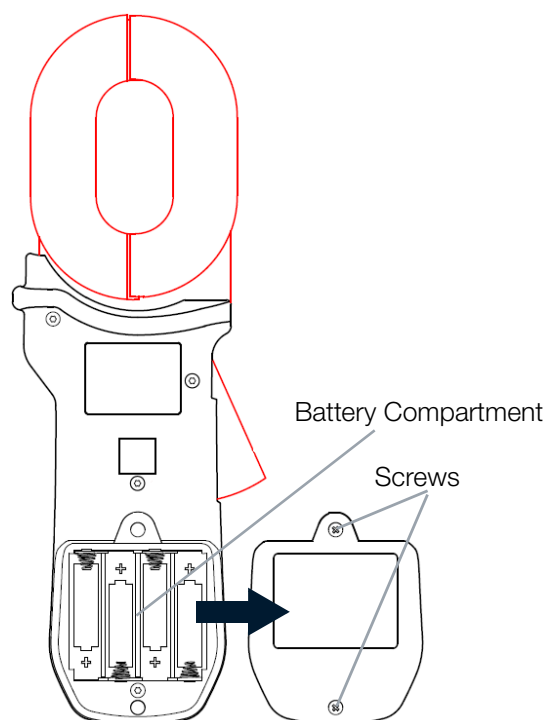
Observe disposal instructions for batteries and rechargeable batteries ⇒ 21.



Charge Level Indicator

The battery symbol is not displayed.	The batteries are sufficiently charged.
 blinks at the display.	The batteries are weak and will need to be replaced soon.
 appears continuously at the display.	All batteries are fully depleted and must be replaced immediately.

6.2 Switching the Instrument On and Off

Turn the rotary switch to any position other than **OFF** in order to switch the instrument on.

Attention!

The instrument performs automatic calibration when started up. The measuring head must be closed and empty for this reason (no conductors may be enclosed).

Turn the rotary switch to the **OFF** position in order to switch the instrument off.

6.3 Setting Date and Time

When using the METRACLIP EARTH PE for the first time, you'll be prompted to set the date and time after switching the instrument on (⇒ 9).

1. Set the year with the ▲ ▼ keys.
 2. Confirm with the ► key.
The month blinks.
 3. Set the month with the ▲ ▼ keys.
 4. Confirm with the ► key.
The day blinks.
 5. Set the day with the ▲ ▼ keys.
 6. Confirm with the ► key.
Time blinks.
 7. Select the display format for time, i.e. 24 or 12-hour clock (a.m. / p.m.), with the ▲ ▼ keys.
 8. Confirm with the ► key.
The hours display blinks.
 9. Set the hour with the ▲ ▼ keys.
 10. Confirm with the ► key.
The minutes display blinks.
 11. Set the minute with the ▲ ▼ keys.
 12. Confirm with the ► key.
- ↳ Date and time have now been set. The instrument is ready for operation.



7 Instrument Settings

7.1 Alarms

You can set an alarm for the impedance and/or the current measurement. As soon as the specified threshold is exceeded, the alarm indicator blinks at the display and shows the corresponding value (Ω for impedance and A for current).

If acoustic signals have been activated (\Rightarrow 11), a continuous acoustic signal is also generated so that you know whether or not the measurement is correct without having to look at the display.

Note!

If alarms have been set for both the impedance and the current measurement, and if both values are exceeded, the alarm for current measurement takes precedence.

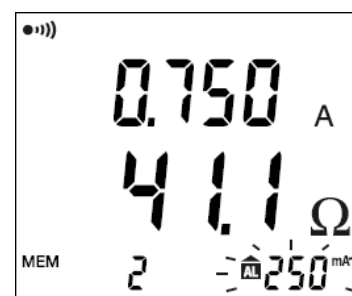



Press and hold the \blacktriangleright key in order to deactivate the alarm.

Alarms for Impedance and Leakage Current Measurements

1. Turn the rotary switch to **SET-UP**.
2. Use the \blacktriangle \blacktriangledown keys to scroll to the **AL Ω** entry.
3. Confirm with the \blacktriangleright key.
The **AL Ω** menu is displayed.
4. De/activate the **AL Ω** function with the help of the \blacktriangle \blacktriangledown keys:

-  **10** Ω = alarm for impedance < 10 Ω

-  **10** Ω = alarm for impedance > 10 Ω

-  **10** Ω = alarm is deactivated

5. Confirm with the \blacktriangleright key.
The setting is saved.
6. After the alarm has been activated: Select a different alarm threshold if necessary (1 to 199 Ω) with the help of the \blacktriangle \blacktriangledown keys.
(Press and hold the keys to scroll through the values faster.)
You'll also be prompted to set the value if the alarm is deactivated. Skip this step by confirming with the \blacktriangleright key.
7. Confirm with the \blacktriangleright key.
The setting is saved.

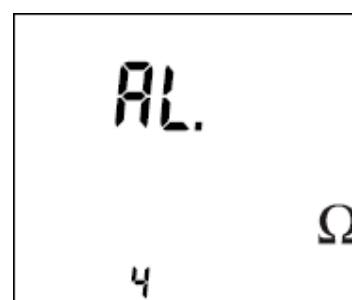

Alarm for Current Measurement

1. Turn the rotary switch to **SET-UP**.
2. Use the \blacktriangle \blacktriangledown keys to scroll to the **ALA** entry.
3. Confirm with the \blacktriangleright key.
The **ALA** menu is displayed.
4. De/activate the **ALA** function with the help of the \blacktriangle \blacktriangledown keys:

-  **30** ^{mA} = alarm for current > 30 mA

-  **30** ^{mA} = alarm is deactivated

5. Confirm with the \blacktriangleright key.
The setting is saved.
6. After the alarm has been activated: Select a different alarm threshold if necessary (1 mA to 20 A) with the help of the \blacktriangle \blacktriangledown keys.
(Press and hold the keys to scroll through the values faster.)
You'll also be prompted to set the value if the alarm is deactivated. Skip this step by confirming with the \blacktriangleright key.
7. Confirm with the \blacktriangleright key.
 \hookrightarrow The setting is saved.

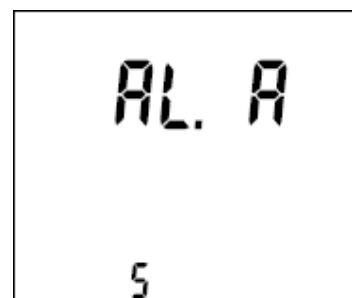

7.2 Acoustic Signals

The instrument can be set to generate a beep when keys are pressed and to emit a continuous acoustic signal in the event of an alarm (⇒ 10).

1. Turn the rotary switch to **SET-UP**.
2. Use the ▲ ▼ keys to scroll to the **Snd** entry.
3. Confirm with the ► key.
The **SND** menu is displayed.
4. De/activate the **Snd** function with the help of the ▲ ▼ keys:
 - ●))) is displayed = acoustic signals are activated
 - ●))) is not displayed = silent operation
5. Confirm with the ► key.
↳ The setting is saved.

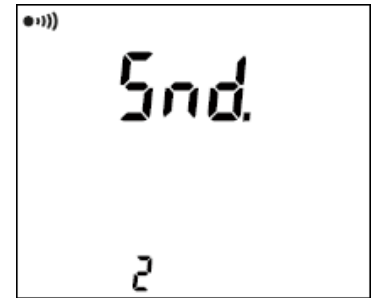

In order to deactivate or reactivate beeping during measurements (⇒ "Operation" 14), press and hold the ► key.

7.3 Automatic Freezing of the Measured Value (PRE-HOLD function)

Either manual or automatic triggering can be selected for the **HOLD** function, i.e. "freezing" the displayed measured value:

- Manual: Press the HOLD key in order to freeze the displayed measured value ⇒ 14.
- Automatic (**PRE-HOLD**): When the measuring head is opened, the displayed, stabilized measured value is automatically frozen. This is convenient if you don't have a free hand to press the **HOLD** key when performing a measurement.

1. Turn the rotary switch to **SET-UP**.
2. Use the ▲ ▼ keys to scroll to the **PRE-HOLD** entry.
3. Confirm with the ► key.
The **PRE-HOLD** menu is displayed.
4. De/activate the **HOLD** function with the help of the ▲ ▼ keys:
 - [HOLD] is displayed = **PRE-HOLD** is activated
 - [HOLD] is not displayed = **PRE-HOLD** is deactivated
5. Confirm with the ► key.
↳ The setting is saved.



7.4 Clearing Memory

The METRACLIP EARTH PE can store 300 measured values with timestamp. These are stored internally as measurement numbers 0 to 299. If 300 values have been stored, i.e. when measurement number 299 is reached, **FULL** and the memory number are displayed alternately.

! Attention!

Overwriting of measured values!

If internal memory is full and you save another value anyway, the first measured value is overwritten (first in, first out).

If this is continued, measurement number 0 is overwritten with measurement number 300 and so forth. This can be continued up to number 9999. At this point, further recording becomes impossible and memory must be cleared in order to once again save measured values.

! Attention!

Data loss!

Back up your data before clearing memory

1. Turn the rotary switch to **SET-UP**.
2. Use the ▲ ▼ keys to scroll to the **CLR** entry.
3. Confirm with the ► key.
The **CLR** menu is displayed.
4. Simultaneously press and hold the ▲ and ▼ keys.
Instrument memory is fully cleared.

**Note!**

The instrument emits 5 beeps before memory is cleared. Press the ► key in order to abort clearing.

- ↳ Memory has now been cleared.
(If you want to make sure that memory has been cleared, turn the rotary switch to **MR** (memory recall), after which the empty measured value memory is displayed.)

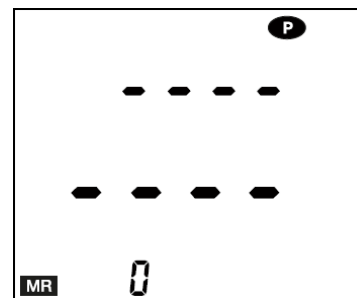
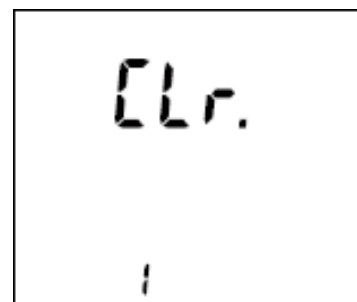

7.5 Automatic Standby Mode

The instrument can be automatically switched to standby after 5 minutes of inactivity in order to extend battery life (⇒ 8). Press any key or turn the rotary switch in order to exit the standby mode.

**Note!**

If the instrument has been in standby mode for more than 15 minutes, it performs automatic calibration when it's woken up (as is also the case when it's switched on ⇒ 9).

1. Turn the rotary switch to **SET-UP**.
 2. Use the ▲ ▼ keys to scroll to the **StOP** entry.
 3. Confirm with the ► key.
The **StOP** menu is displayed.
 4. De/activate the **StOP** function with the help of the ▲ ▼ keys:
 - **P** is displayed = automatic shutdown is activated
 - **P** is not displayed = continuous operation
 5. Confirm with the ► key.
- ↳ The setting is saved.

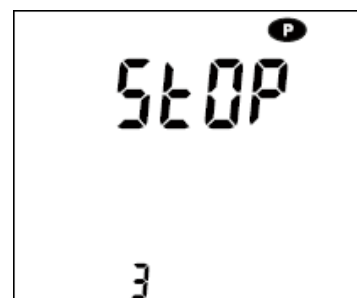

7.6 Setting Date and Time

Date and time are normally set during initial startup (⇒ 8). However, these settings can be changed at any time.

Setting the Date

1. Turn the rotary switch to **SET-UP**.
 2. Use the ▲ ▼ keys to scroll to the **dAtE** entry.
 3. Confirm with the ► key.
The **dAtE** menu is displayed. The month blinks.
 4. Set the digits which indicate the date with the ▲ ▼ keys.
 5. Confirm with the ► key.
The day blinks.
 6. : Set the digits which indicate the date with the ▲ ▼ keys.
 7. Confirm with the ► key.
- ↳ The setting is saved.



Setting Time

1. Turn the rotary switch to **SET-UP**.
2. Use the ▲ ▼ keys to scroll to the **HOUR** entry.
3. Confirm with the ► key.
The **HOUR** menu is displayed.
4. Select the display format for time, i.e. 24 or 12-hour clock (a.m. / p.m.), with the ▲ ▼ keys.
5. Confirm with the ► key.
The hours display blinks.
6. Set the hour with the ▲ ▼ keys.
7. Confirm with the ► key.
The minutes display blinks.
8. Set the minute with the ▲ ▼ keys.
9. Confirm with the ► key.
- ↳ The setting is saved.



7.7 Querying Instrument Information

You can view the instrument's current firmware version and its serial number. Both are important for service and support requests (⇒ 20).

Viewing the Firmware Version

1. Turn the rotary switch to **SET-UP**.
2. Use the ▲ ▼ keys to scroll to the **VER** entry.
3. Confirm with the ► key.
The **VER** menu is displayed.
4. Confirm with the ► key.
- ↳ The firmware version is displayed.

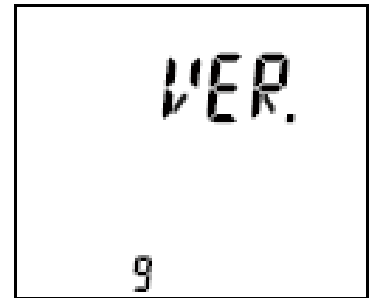

Viewing the Serial Number

1. Turn the rotary switch to **SET-UP**.
2. Use the ▲ ▼ keys to scroll to the **VER** entry.
3. Confirm with the ► key.
The **VER** menu is displayed.
4. Confirm with the ► key.
The firmware version is displayed.
5. Press the ▼ key.
- ↳ The serial number is displayed.

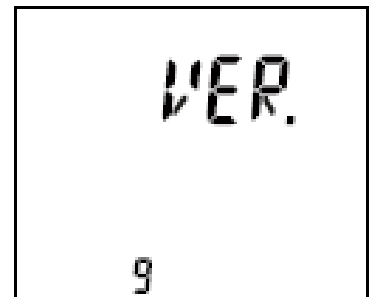

8 Operation

This section first describes the basics of working with measured values, followed by details covering all aspects of the various measurements:

- General Information on Measurements ⇨ 14
- Freezing the Measured Value (HOLD) ⇨ 14
- Saving Measured Values ⇨ 15.
- Impedance and Leakage Current Measurements ($\Omega + A$) ⇨ 15
- Current Measurement (A) ⇨ 16
- Readjustment ⇨ 16
- Viewing Measured Values (measured value memory) ⇨ 16

8.1 General Information on Measurements

The device under test (conductor) must be enclosed during any given measurement. Measurement is then started automatically. The measuring head has to be opened and closed again in order to start another measurement.

In order to enclose the device under test, open the measuring head by pressing the jaw release trigger. The measuring head closes again when the trigger is released.

! Attention!

The measuring head must be fully closed. Otherwise, measurement cannot be performed.

The following DUTs can be measured with the instrument:

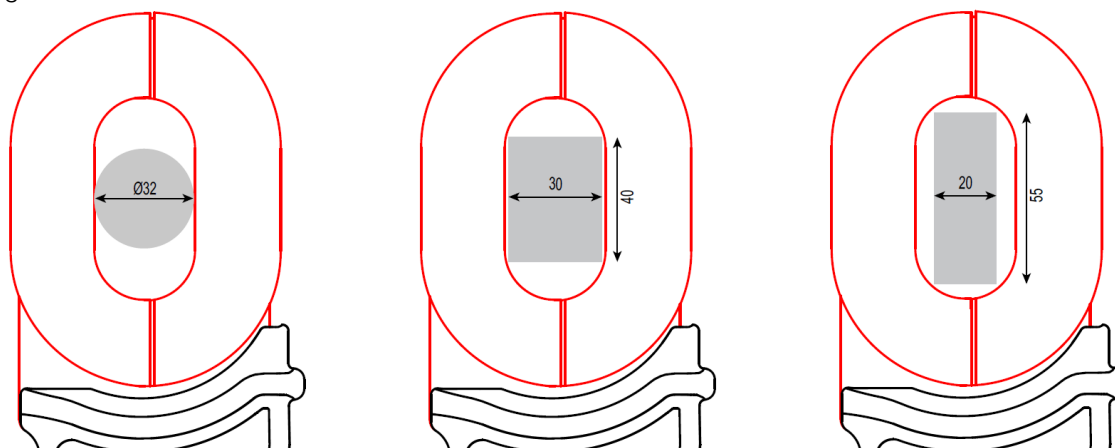

Enclosing Capacity: Round 32 mm, Square 30 × 40 mm, Rectangular 20 × 55 mm

! Attention!

Interference

Magnets must be at least 10 cm from the instrument when performing measurements.

In order to hold the instrument securely and comfortably in your hand during measurement, the strap can be used to secure it around your wrist.

Display illumination can be switched on if necessary, in order to make it easier to read the display. Press the  key to this end.

8.2 Freezing the Measured Value (HOLD)

A measured value can be “frozen” during a measurement with the help of the Hold function.

1. Press the **HOLD** function key.
The measured value is frozen. **HOLD** appears at the display.
2. Press the **HOLD** function key again to release the measured value.

Note!

If the automatic **HOLD** function has been activated (⇨ 11), the measured value is automatically frozen if the clamp is opened during a measurement.

8.3 Saving Measured Values

Measured values can be saved. Stored data includes:

- Measured value
- Timestamp
- Memory location number
- Any alarms and whether or not one was triggered (⇨ 10)
- Any auxiliary displays (**HOLD** for freezing ⇨ 14, **P** for standby mode ⇨ 12)
- Any errors (**NOISE, OR, LOOP** ⇨ 19)

The METRACLIP EARTH PE can store 300 measured values. These are stored internally as measurement numbers 0 to 299. If 300 values have been stored, i.e. when measurement number 299 is reached, **FULL** and the memory number are displayed alternately.

! Attention!

Overwriting of measured values!

If internal memory is full and you save another value anyway, the first measured value is overwritten (first in, first out).

If this is continued, measurement number 0 is overwritten with measurement number 300 and so forth. This can be continued up to number 9999. At this point, further recording becomes impossible and memory must be cleared in order to once again save measured values ⇨ "Clearing Memory" 11.

1. Wait until the displayed measured value has settled in.
 2. Press the **MEM** function key.
- ↳ The measured value is stored along with the timestamp. The number of the memory location is displayed next to **MEM**.

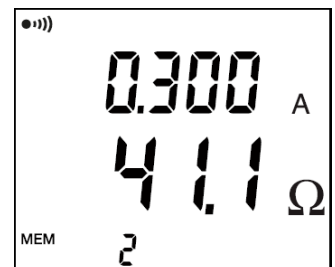

8.4 Impedance and Leakage Current Measurements ($\Omega + A$)

The instrument measures impedance (Ω) with a fixed test-signal frequency of 2083 Hz, as well as leakage current.

Measured earth resistance R_x is connected in parallel to the other via ground Z_E and earth conductor Z_S . Impedance measured by the clamp meter is slightly greater than R_x ($Z_{Loop} \approx R_x$).

For initial measurement and for the sake of increased accuracy, earthing should first be measured with auxiliary earth electrodes. Further testing can then be conducted with the METRACLIP EARTH PE.

If testing is conducted at regular intervals, any sudden change to the measured value indicates a defect.

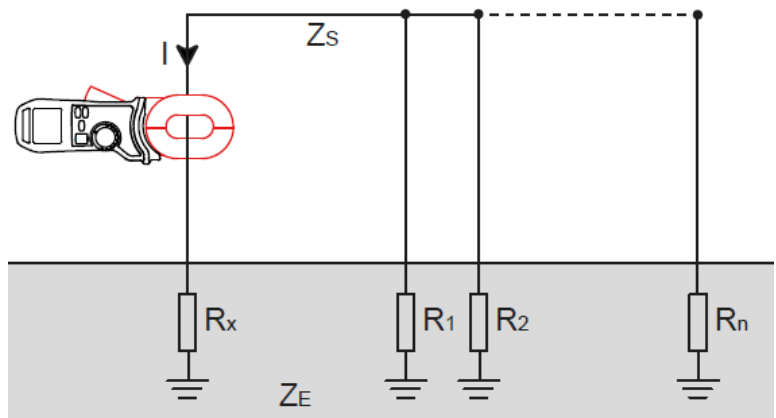

! Attention!

Interference

Live conductors must be at least 10 cm away from the instrument.

👉 Note!

An intermittent beep is generated during impedance measurement (beep ... beep ...). This acoustic signal cannot be deactivated because it's the audible frequency of the test signal in the measuring head. The acoustic signal fluctuates along with the frequency and the amplitude of the measured current.

1. Open the measuring head by pressing the jaw release trigger.
2. Enclose the device under test.

3. Turn the rotary switch to $\Omega+A$.
 4. Measurement is started automatically.
 5. Wait until the measured value has settled in.
 6. Store (\Rightarrow 15) or freeze (\Rightarrow 14) the measured value.
 7. Remove the instrument from the device under test.
- \hookrightarrow The measurement has been completed.

8.5 Current Measurement (A)

When measuring current, the instrument serves as a normal current clamp transformer.

! Attention!

Dangerous Overheating

Maintain a signal frequency of 47 to 800 Hz. The clamp meter heats up dangerously at over 20 A and 800 Hz.

1. Open the measuring head by pressing the jaw release trigger.
 2. Enclose the device under test.
 3. Turn the rotary switch to A.
 4. Measurement is started automatically.
 5. Wait until the measured value has settled in.
 6. Store (\Rightarrow 15) or freeze (\Rightarrow 14) the measured value.
 7. Remove the instrument from the device under test.
- \hookrightarrow The measurement has been completed.

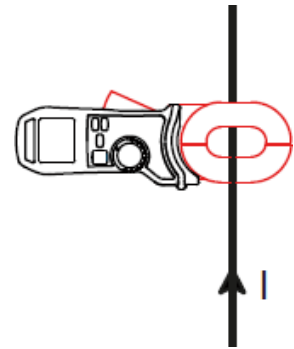

8.6 Viewing Measured Values (measured value memory)

1. Turn the rotary switch to **MR** (memory recall).
The most recently stored measurement is displayed.
 2. Optional: Use the \blacktriangle \blacktriangledown keys to scroll to additional measured values.
 3. Optional: Press the \blacktriangleright key in order to view a measurement's timestamp.
- \hookrightarrow The measured value and its time stamp are displayed.

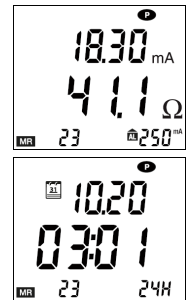

8.7 Readjustment

The calibration loop included with the instrument can be used to check impedance adjustment (Ω).

If necessary, you can readjust the instrument yourself for all measurements, so that the clamp meter can be balanced without sending it to the manufacturer. Readjustment can also be undone and the instrument can be reset to its default settings.

If readjustment is not successful, the instrument will have to be returned to the manufacturer (\Rightarrow "Service and Support" 20).

👉 Note!

Access to the readjustment menu is made intentionally difficult in order to prevent inadvertent maladjustment of the clamp meter.

8.7.1 Balancing Adjustment with the Calibration Loop

In order to check impedance adjustment (Ω), perform impedance and leakage current measurements ($\Omega + A$) using the calibration loop instead of a conductor. Enclose a measuring point on the calibration loop with the measuring head to this end. Then compare the measured value with the value printed on the calibration loop. Repeat this test with all measuring points on the calibration loop.

- Value (nearly) identical: the instrument is calibrated correctly.
- Value deviates significantly: perform readjustment (\Rightarrow 17). Check calibration again and if the results are still not satisfactory, contact our service and support department \Rightarrow 20.

8.7.2 Readjusting Impedance and Leakage Current Measurements

1. Turn the rotary switch to **SET-UP**.
 2. Use the **▲ ▼** keys to scroll to the **CAL** entry.
 3. Simultaneously press and hold the **▶ ▲ ▼** keys.
The readjustment menu appears.
 4. Use the **▲ ▼** keys to scroll to the **CAL R** entry.
 5. Press and hold the **▶** key for at least 3 seconds.
The readjustment menu for impedance and leakage current measurement appears. **NO LOOP** and **PRESS RT** are displayed alternately.
 6. Make sure that a conductor is not enclosed by the clamp (**NO LOOP**) and that the measuring head is closed.
 7. Press the **▶** key.
The clamp meter is adjusted with its own resistance of 10 Ω . This takes a while. After adjustment has been completed, the results appear: **PASS** (adjustment successful) or **FAIL** (adjustment failed).
 8. **PASS**: If adjustment has been successful, press the **▶** key.
FAIL: Repeat the adjustment procedure from the beginning.
- ↳ Adjustment of impedance and leakage current measurement is finished.

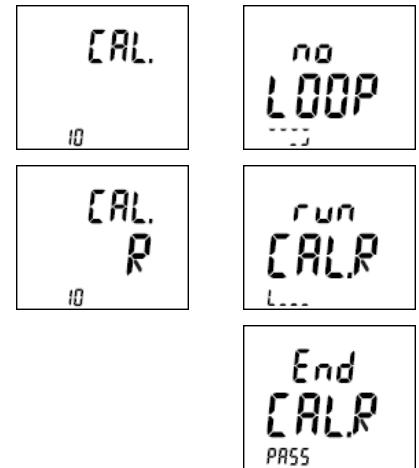

8.7.3 Readjusting the Current Measurement

A stabilized, adjustable current source is required which generates alternating current within a range of 0.1 to 10 A. Readjustment of the current measurement consists of several sub-adjustments, which are evaluated individually. If **FAIL** is displayed as your result, you'll have to eliminate the cause of error (e.g. set the current source correctly) and start adjustment once again from the beginning.

1. Turn the rotary switch to **SET-UP**.
 2. Use the **▲ ▼** keys to scroll to the **CAL** entry.
 3. Simultaneously press and hold the **▶ ▲ ▼** keys.
The readjustment menu appears.
 4. Use the **▲ ▼** keys to scroll to the **CAL I** entry.
 5. Press and hold the **▶** key for at least 3 seconds.
The readjustment menu for the current measurement appears. **100mA SET** and **PRESS RT** are displayed alternately.
 6. Set the current source so that 100 mA flow through the cable.
 7. Enclose the cable with the measuring head.
 8. Press the **▶** key.
The instrument executes the first step for readjustment of the current measurement. This takes a while. After adjustment has been completed, the results appear: **PASS** (adjustment successful) or **FAIL** (adjustment failed).
 9. **PASS**: If adjustment has been successful, press the **▶** key.
 10. Remove the measuring head from the cable.
5.00mA SET and **PRESS RT** are displayed alternately.
 11. Set the current source so that 5 A flow through the cable.
 12. Enclose the cable with the measuring head.
 13. Press the **▶** key.
The instrument executes the second step for readjustment of the current measurement. This takes a while. After adjustment has been completed, the results appear: **PASS** (adjustment successful) or **FAIL** (adjustment failed).
 14. **PASS**: If adjustment has been successful, press the **▶** key.
 15. Remove the measuring head from the cable.
15.00mA SET and **PRESS RT** are displayed alternately.
 16. Set the current source so that 15 A flow through the cable.
 17. Enclose the cable with the measuring head.
 18. Press the **▶** key.
The instrument executes the third step for readjustment of the current measurement. This takes a while. After adjustment has been completed, the results appear: **PASS** (adjustment successful) or **FAIL** (adjustment failed).
 19. **PASS**: If adjustment has been successful, press the **▶** key.
- ↳ Adjustment of impedance and leakage current measurement is finished.

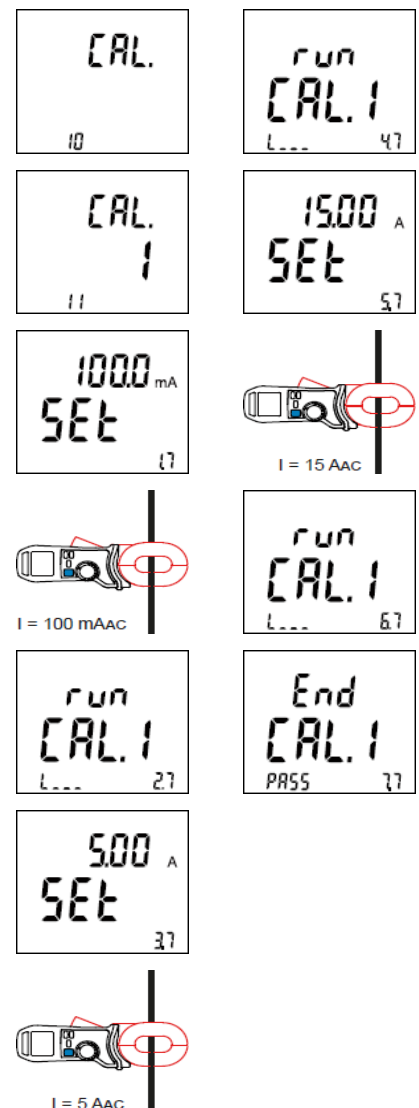







8.7.4 Resetting Adjustments

The instrument's adjustment settings can be reset to their default values. The selected device configuration and stored measurements are retained.

1. Turn the rotary switch to **SET-UP**.
 2. Use the ▲ ▼ keys to scroll to the **CAL** entry.
 3. Simultaneously press and hold the ► ▲ ▼ keys.
The readjustment menu appears.
 4. Use the ▲ ▼ keys to scroll to the **dFLt** entry.
 5. Press and hold the ► key for at least 3 seconds.
The **dFLt** menu is displayed. **PRESS RT** is displayed.
 6. Confirm with the ► key.
The instrument is reset. After resetting has been completed, the results appear:
PASS (reset successful) or **FAIL** (reset failed).
 7. **PASS**: If resetting has been successful, press the ► key.
FAIL: Repeat the reset procedure from the beginning.
- ↳ The instrument's adjustment settings are reset to their default values.

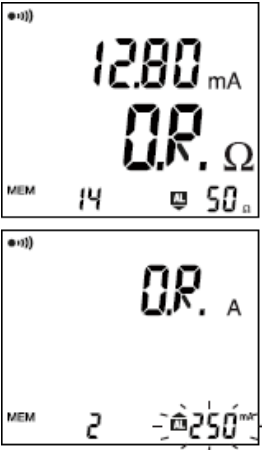
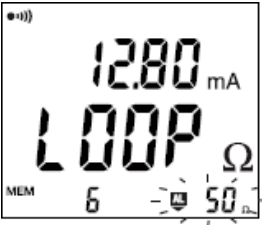

9 Troubleshooting

Error	Cause & Remedy
<p>Err. CAL appears at the display.</p>	<p>Automatic calibration during instrument startup has failed.</p> <p>Switch the instrument back off and make sure that:</p> <ul style="list-style-type: none"> • No conductor is enclosed / the measuring head is empty • The measuring head is closed • The opening gap between the measuring head sections (iron core) is clean <p>Switch the instrument on.</p>
<p>No measurements can be performed.</p> <p> appears at the display.</p>	<p>The measuring head is open. No measurements can be performed when the measuring head is open.</p> <p>Fully close the measuring head. Maximum diameters of conductors to be measured → "Technical Data" 5.</p>
<p>O.R. appears at the display (overranging).</p> 	<p>The measured value exceeds the measuring range limits.</p> <p>(impedance > 1200 Ω)</p> <p>(current > 20 A)</p>
<p>LOOP appears at the display.</p> 	<p>If an impedance of less than 1 Ω is measured, the measured value and the LOOP message appear alternately at the display.</p> <p>This value is very weak for an earth loop.</p> <p>Double-check the test setup. A local loop may have been enclosed at the measurement point instead of the earth loop.</p>
<p>NOISE appears at the display.</p> 	<p>Excessive current (> 5 A) or voltage ($Z \times I > 25 \text{ V}$) has been applied during the impedance and leakage current measurement. As a result, the displayed measured value is incorrect.</p> <p>If current is greater than 10 A, the impedance value is no longer displayed.</p>
<p>The measured value cannot be saved.</p> <p> appears at the display.</p>	<p>Charged batteries are required in order to store measured values. Replace depleted batteries with charged batteries → "Establishing Power Supply (batteries / rechargeable batteries)" 8.</p>

10 Maintenance

Cleaning

No special maintenance is required for the instrument. Keep the opening gap / internal iron core of the measuring head impeccably clean and ensure that outside surfaces are clean as well.

Attention!

Avoid the use of cleansers, abrasives or solvents!

- ✓ The instrument is not connected to any other device (e.g. device under test).
 - ✓ The instrument is switched off ⇨ “Switching the Instrument On and Off” .
1. Clean the instrument using a cloth which has been slightly moistened with soapy water.
 2. Then wipe it off using a cloth which has been slightly moistened with water.
 3. Dry the instrument quickly using a dry cloth or a warm air blower.
 4. Wait until the instrument is completely dry.
- ↳ The cleaned instrument can then be used again.

Replacing Batteries / Rechargeable Batteries

(see “Establishing Power Supply (batteries / rechargeable batteries)” ⇨ .

11 Service and Support

11.1 Product Support

If required please contact:

Gossen Metrawatt GmbH

Product Support Hotline

Phone +49 911 8602-0

Fax +49 911 8602-709

e-mail support@gossenmetrawatt.com

11.2 Repair and Replacement Parts Service Calibration Center * and Rental Instrument Service

If required please contact:

GMC-I Service GmbH

Service Center

Beuthener Str. 41

D-90471 Nürnberg, Germany

Phone +49 911 817718-0

Fax +49 911 817718-253

e-mail service@gossenmetrawatt.com

Web www.gmci-service.com

This address is only valid in Germany.

Please contact our representatives or subsidiaries for service in other countries.

11.2.1 Competent Partner

Gossen Metrawatt GmbH is certified in accordance with DIN EN ISO 9001.

Our **DAkkS calibration laboratory** is accredited by the Deutsche Akkreditierungsstelle GmbH (national accreditation body for the Federal Republic of Germany) under registration number D-K-15080-01-01 in accordance with DIN EN ISO/IEC 17025.

Accredited quantities: direct voltage, direct current value, direct current resistance, alternating voltage, alternating current value, AC active power, AC apparent power, DC power, capacitance, frequency and temperature.

We offer a complete range of expertise in the field of metrology: from test reports and factory calibration certificates right on up to DAkkS calibration certificates.

An on-site DAkkS calibration station is an integral part of our service department. If errors are discovered during calibration, our specialized personnel is capable of completing repairs using original replacement parts.

As a full service calibration laboratory, we can calibrate instruments from other manufacturers as well.

Our spectrum of offerings is rounded out with free test equipment management.

12 CE Declaration

The instrument fulfills all requirements of applicable EU directives and national regulations. We confirm this with the CE mark. The CE declaration is available upon request.

A factory calibration certificate or test report is included with the instrument.

13 Returns and Environmentally Sound Disposal

This instrument is subject to directive 2012/19/EC on Waste Electrical and Electronic Equipment (WEEE) and its German national equivalent implemented as the Waste Electrical and Electronic Equipment Act (ElektroG) on the marketing, return and environmentally sound disposal of electrical and electronic equipment. The instrument is a category 9 product (monitoring and control instrument) in accordance with ElektroG (German Waste Electrical and Electronic Equipment Act).



The symbol at the left indicates that this instrument and its electronic accessories must be disposed of in accordance with applicable legal regulations, and not together with household trash. In order to dispose of the instrument, bring it to a designated collection point or contact our product support department (→ 20).

This instrument is also subject to directive 2006/66/EC on batteries and accumulators and waste batteries and accumulators and its German national equivalent implemented as the Battery Act (BattG) on the marketing, return and environmentally sound disposal of batteries and accumulators.



The symbol at the left indicates that batteries and rechargeable batteries must be disposed of in accordance with applicable legal regulations. Batteries and rechargeable batteries may not be disposed of with household trash. In order to dispose of the batteries or rechargeable batteries, remove them from the instrument and bring them to a designated collection point.

Segregated disposal and recycling conserves resources and protects our health and the environment.

Current and further information is available on our website at <http://www.gossenmetrawatt.com> under the search terms "WEEE" and "environmental protection".

© Gossen Metrawatt GmbH

Prepared in Germany • Subject to change, errors excepted • PDF version available on the Internet

All trademarks, registered trademarks, logos, product names and company names are the property of their respective owners.



Gossen Metrawatt GmbH
Südwestpark 15
90449 Nürnberg • Germany

Phone: +49 911 8602-0
Fax: +49 911 8602-777
e-mail: info@gossenmetrawatt.com
www.gossenmetrawatt.com