

Controls

Display of symbols for devices connected to the USB master interface (see below)

- For keyboard *
- For barcode/RFID scanner *
- For printer
- For USB drive

Bluetooth®** (Feature M01)
Parameters see page 73

Display of special symbols:

- Measurement at IT system active
- Offset for RPE active

Lightning symbol:
mains to test socket

White identified and fused high current path

Standard test probe

Connection for service plug only

LCD panel

Fixed Function Keys

PRINT: Print via USB

ESC: Return

HELP: Help images

MEM: Database functions

START: Start/stop
– Single meas.
– Test sequence
Finger contact

Softkeys

Rotary switch level: orange
Sequences A1 ... A8, AUTO (automatic test sequences)

Rotary selector switch

Rotary switch level: green
Single measurements



- * The receiver must be plugged in here for wireless entry devices.
- ** is only shown while a connection with another Bluetooth device is active

Connections



SECLIFE ST BASE (M7050-V101) corresponds to the range of functions offered by **SECUTEST PRO**, but is additionally endowed with **antimicrobial properties**.

No.	Meaning
1	2 nd test probe for 2-pole measurement SECUTEST PRO only (or device with feature H01)
2	Voltage measuring inputs SECUTEST PRO only (or device with feature I01))
3	Fuse link for the probe input
4	Test probe connection (P1)
5	Connection (jack socket) for service plug only!
6	Country-specific standard socket (test socket) for connecting devices under test
7	Carrying handle and tilt stand
8	Country-specific socket for mains power via inlet plug
9	Fuse link 1 for the mains connection
10	Fuse link 2 for the mains connection
11	Fuse link for 10 A protective conductor test (additionally with SECUTEST BASE10 (feature G01) or SECUTEST PRO)
12	USB master for connecting keyboard, barcode/RFID scanner*, printer* and USB flash drive* (FAT formatted, not NTFS)
13	USB slave for connection to a PC

* A list of suitable devices is included in the appendix (see section 14).

These operating instructions describe an instrument with software version FW1.8.2.

Overview of Features Included with SECUTEST BASE(10), PRO and SECULIFE ST BASE Test Instruments

Switch Position	Measuring Function Test Current/Voltage	Measurement Type, Connection Type
Single measurements, rotary switch level: green		
Section 8.5	R_{PE} Protective conductor resistance	PE(TS) - P1 passive PE(TS) - P1 active
	I_P Test current (200 mA) SECUTEST BASE10/PRO, SECULIFE ST BASE: 10 A¹ (feature G01)	PE(mains) - P1 PE(mains) - P1 clamp ² P1-P2 ³
Section 8.6	R_{ISO} Insulation resistance (PC I/PC II)	LN(TS) - PE(TS) LN(TS) - P1 P1-P2 ³
	U_{ISO} Test voltage	PE(mains) - P1 PE(TS) - P1 LN(TS) - P1//PE(TS)
Section 8.7.1	I_{PE≈} Protective conductor current, RMS	Direct
	I_{PE-} AC component	Differential
	I_{PE=} DC component	Alternative AT3-Adapter ²
	U_{LN} Test voltage	Clamp ²
Section 8.7.2	I_{B≈} Touch current, RMS	Direct
	I_{B-} AC component	Differential
	I_{B=} DC component	Alternative (P1) Perm. connection
	U_{LN} Test voltage	Alternative (P1-P2)
Section 8.7.3	I_{G≈} Device leakage current, RMS	Direct
	I_{G-} AC component	Differential
	I_{G=} DC component	Alternative AT3-Adapter ²
	U_{LN} Test voltage	Clamp ²
Section 8.7.4	I_{A≈} Leakage current from the applied part, RMS	Direct (P1)
	U_A Test voltage	Alternative (P1) Perm. con. (P1)
Section 8.7.5	I_{P≈} Patient leakage current, RMS	
	I_{P-} AC component	Direct (P1)
	I_{P=} DC component	Perm. con. (P1)
	U_{LN} Test voltage	
Section 8.9	U_≈ Probe voltage, RMS	P1-P2
	U₋ Alternating voltage component	P1-P2 (with mains*) * Polarity param.
	U₌ Direct voltage component	
	U_≈ Measuring voltage, RMS²	
	U₋ Alternating voltage component ²	V - COM
Section 8.10	U₌ Direct voltage component ²	V - COM (with mains)
	ta ⁴ PRCD time to trip for 30 mA PRCDs	
Section 8.11	U_{LN} Line voltage at the test socket	
	P Function test at the test socket	
	I Current between L and N	
	U Voltage between L and N	
	f Frequency	Polarity parameter
	P Active power	
Section 8.12	S Apparent power	
	PF Power factor	
Probe Measuring Functions		
Section 8.12	Extension cord with adapter: continuity, short-circuit, polarity (wire reversal)	EL1 adapter AT3-III-E adapter VL2E adapter
Section 9	Reserved for expansion during the course of software updates	
	°C/°F Temperature measurement ² with Pt100 / Pt1000	V - COM

- ¹ 10 A R_{PE} measurements are only possible with line voltages of 115/230 V and line frequencies of 50/60 Hz.
- ² Voltage measuring inputs with **SECUTEST PRO** and **SECULIFE ST BASE** only (or instrument with feature IO1)
- ³ Connection for 2nd test probe for 2-pole measurement with **SECUTEST PRO** and **SECULIFE ST BASE** only (or instrument with feature H01)
- ⁴ Measurement of time to trip is not possible in IT systems.
- ⁵ No checking for reversed polarity takes place when the EL1 adapter is used.

Key

- Alternative = alternative measurement (eq. leakage current meas.)
 Differential = differential current measurement
 Direct = direct measurement
 LN(TS) = short-circuited L and N conductors at test socket
 P1 = measurement with test probe P1
 P1-P2 = 2-pole measurement with test probes P1 and P2
 PE-P1 = measurement between PE and test probe P1
 PE(TS) = protective conductor at the test socket
 PE(mains) = protective conductor at the mains connection

Switch Position	Standard	Measurement Type, Connection Type
Automated test sequences, rotary switch level: orange		
Preconfigured (freely adjustable) test sequences – default settings		
A1	VDE 0701-0702	Passive measurement type, test socket
A2	VDE 0701-0702	Active measurement type, test socket
A3	VDE 0701-0702-EDV	Parametrization for EDP (active)
A4	IEC 62353 (VDE 0751)	Active measurement type
A5	IEC 62353 (VDE 0751)	Active measurement type
A6	IEC 60974-4	Connection type: test socket
A7	IEC 60974-4	Connection type: AT16-DI/AT32-DI
A8	VDE 0701-0702	Extension cord measurement type (RPE, RISO), adapter: EL1/VL2E/AT3-III-E
AUTO	VDE 0701-0702	Active measurement type, test socket

Differences with Regard to Included Features

Feature	SECUTEST BASE	SECUTEST BASE10	SECUTEST PRO SECULIFE ST BASE
10 A RPE test current		•	•
Touch-screen keyboard			•
2 nd test probe			•
Voltage meas. inputs *			•
Database expansion			•

* For voltage measurement or for connecting a current clamp sensor, or an AT3 adapter, and for temperature measurement via RTD

Scope of Delivery

Standard Version (country-specific)

- SECUTEST BASE(10), PRO or SECULIFE ST BASE test instrument
- Mains power cable
- Test probe, 2 m, not coiled
- USB cable, USB A to USB B, 1.0 m long
- Plug-on alligator clip
- KS17-ONE cable set for voltage measuring input (only with **SECUTEST PRO** and **SECULIFE ST BASE** or instrument with feature IO1)
- Calibration certificate
- Condensed operating instructions
- Comprehensive operating instructions available on the Internet
- ETC report software available on the Internet

The most up-to-date version of ETC report generating software can be downloaded free of charge from the **mygmc** page of our website as a ZIP file, if you have registered your test instrument:
<http://www.gossenmetrawatt.com>
 → Products → Software → Software for Testers → Report Software without Database → ETC → [myGMC](#)



Attention!

The following must be observed if other software packages are used: ETC report generating software must first be installed on the PC in order to be able to read out data with the help of other software packages such as **PC.doc-WORD/EXCEL**, **PC.doc-ACCESS**, **ELEKTRO manager** and **PS3**.

Contents	Page	Contents	Page
1 Applications	5	8 Single Measurements	21
1.1 Table: Types of DUTs – Tests – Standards	5	8.1 General	21
1.2 Table: Single Measurements and Regulations	5	8.2 Meaning of Symbols in the User Interface	22
2 Safety Features and Precautions	5	8.3 Displaying the Last Measured values	22
3 General Operation	7	8.4 Measurement Series and Storage	22
3.1 Measured Value Display	7	8.5 Measuring Protective Conductor Resistance – RPE	23
3.2 Language, Keyboard Layout (culture parameter)	7	8.6 Insulation Resistance Measurement – RISO	27
3.3 Help Functions (HELP key and QR code)	7	8.7 Measuring Leakage Current	30
3.4 Entering Alphanumeric Characters	7	8.7.1 Protective Conductor Current – IPE	31
3.5 Print-Outs – Reports	7	8.7.2 Touch Current – IB	35
3.5.1 Multiprint (only with database extension Z853R or with feature KB01)	7	8.7.3 Device Leakage Current – IG	38
3.5.2 Report Template	7	8.7.4 Leakage Current from the Applied Part – IA	41
3.5.3 Report Tapes from Thermal Printers	7	8.7.5 Patient Leakage Current – IP	42
3.5.4 Printing via ETC	8	8.8 Probe Voltage – U	44
3.6 Print-Out of Barcodes (as of firmware V1.3.0)	8	8.9 Measuring Voltage – U (with SECUTEST PRO or feature I01 only)	45
3.7 Writing RFID Tags (as of firmware V1.5.0)	8	8.10 Measuring Time to Trip for RCDs of the Type PRCD – tA	46
3.8 Saving Reports to a USB Flash Drive (only with database extension Z853R or with feature KB01)	8	8.11 Function Test – P	47
4 Initial Start-Up	8	8.12 Testing Extension Cords – EL1	48
4.1 Connecting the Test Instrument to the Mains	8	9 Special Functions – EXTRA	50
4.1.1 Measurements in IT Systems (new parameter as of firmware 1.5.0)	9	10 Test Sequences	51
4.1.2 Automatic Recognition of Mains Connection Errors	9	10.1 General	51
4.2 Connecting Test Probe P1 or P2	9	10.2 Selecting and Configuring a Test Sequence	53
4.3 Device Settings	10	10.3 Connecting the DUT	57
5 Internal database	13	10.4 Selecting a DUT	57
5.1 Creating Test Structures, General	13	10.5 Checking Connection and Starting the Test Sequence	57
5.2 Transmitting and Saving Test Structures and Measurement Data	13	10.6 Executing and Evaluating Test Steps	57
5.2.1 Export – Transmitting Test Structures and Measurement Data from the Test Instrument to the PC	13	10.7 Setting Limit Values Manually	58
5.2.2 Import – Uploading Test Structures Created in ETC to the Test Instrument (only with database extension Z853R or with feature KB01)	13	10.8 Ending the Test Sequence	58
5.2.3 Backing Up and Restoring Test Structures and Measurement Data	13	10.9 Saving Test Results	58
5.3 Data Entry	15	11 Warnings, Error Messages and Notes	59
5.3.1 Keyboard Entries via Softkeys or External Keyboard	15	11.1 List of error messages	60
5.3.2 Data Entry via Touch-Screen Keyboard (only with SECUTEST PRO or instrument with feature E01)	15	11.2 List of Possible DUT Connections Depending on Measurement Type	67
5.4 Creating a Test Structure in the Test Instrument, Navigating within the Structure and Displaying Measured Values	16	12 Characteristic Values	68
5.4.1 General Procedure for Creating Test Structures	17	13 Maintenance	71
5.4.2 Searching for Structure Elements	17	13.1 Housing Maintenance	71
5.4.3 Displaying Measured Values from Saved Tests	17	13.2 Testing the Color Display and the Buzzer (self-test parameter)	71
5.4.4 Backing Up and Restoring the Database	17	13.3 Software Update (system info parameter)	71
5.4.5 Deleting the Database	17	13.4 Backup Battery for Real-Time Clock	71
6 Connecting the Device Under Test	18	13.5 Fuse Replacement	71
6.1 Residual Current Monitoring	18	13.6 Recalibration	71
6.2 Specifying Reference Voltage L-PE and Test Sequence Alternative	18	13.7 Technical Safety Inspections	71
6.3 Manually Specifying the Connection Type for Single Measurements	18	13.8 Returns and Environmentally Sound Disposal	72
6.4 Manually Selecting a Connection Type / Protection Class for Automatic Test Sequences	18	14 Appendix	72
6.5 Special Conditions	19	14.1 List of Suitable Printers with USB connection	72
6.6 2nd Test Probe (only SECUTEST PRO or feature H01)	19	14.2 List of Suitable Barcode Scanners and RFID Scanners with USB connection	72
6.7 Connection Prompts	19	14.3 Application of USB Storage Devices	72
6.8 Connection Tests Conducted by the Test Instrument	19	14.4 Bluetooth Interface (Feature M01)	73
7 Notes on Saving Single Measurements and Test Sequences	20	14.5 Index	74
		15 Repair and Replacement Parts Service Calibration Center and Rental Instrument Service	75
		16 Product Support	75

1 Applications

1.1 Table: Types of DUTs – Tests – Standards

DUTs in accordance with the following standards	Testing after Repairs / Periodic Testing		
	DIN EN 62638, draft DIN VDE 0701-0702	IEC 62353:2007 DIN EN 62353:2008 (VDE 0751-1)	IEC 60974-4:2010 DIN EN 60974-4:2011 VDE 0544-4:2011
Electric devices	•		
Work devices	•		
Mains operated electronic devices	•		
Hand-held electric tools	•		
Extension cords	•		
Household appliances	•		
Data processing devices	•		
Electrical medical devices, applied parts		•	
Welding units			•



Attention!

The test instrument may not be used for measurements within electrical systems!



Attention!

The test instrument must be operated in the same mains system as the DUT!

1.2 Table: Single Measurements and Regulations

Single measurements per regulation	DIN EN 62638, draft DIN VDE 0701-0702:2008	IEC 62353:2007 DIN EN 62353:2008 (VDE 0751-1)	IEC 60974-4:2010 DIN EN 60974-4:2011 VDE 0544-4:2011
	Protective conductor resistance	•	•
Insulation resistance	•	•	•
Protective conductor current	•		
Primary leakage current			•
Device leakage current		•	
Touch current	•	•	
Current from welding circuits			•
Patient leakage current		•	
Leakage current from the applied part		•	
Test methods			
Alternative measurement method	Equivalent (device) leakage current)	•	•
Differential current measuring method		•	•
Direct measuring method		•	•

Key

- Specified test

2 Safety Features and Precautions

SECUTEST BASE(10), SECUTEST PRO and SECULIFE ST BASE test instruments fulfill the requirements of the applicable EU guidelines and national regulations. We confirm this with the CE mark. The relevant declaration of conformity can be obtained from GMC-I Messtechnik GmbH.

The test instruments are manufactured and tested in accordance with the following safety regulations: IEC 61010-1 / DIN EN 61010-1 / VDE 0411-1, DIN VDE 0404, DIN VDE 0413 parts 2 and 4, DIN EN 61557-16/VDE 0413-16 .

The safety of the user, the test instrument and the device under test (electrical equipment or electrical medical device) is only assured when the instrument is used for its intended purpose.

Read the operating instructions carefully and completely before placing your test instrument into service. Follow all instructions contained therein. Make sure that the operating instructions are available to all users of the instrument.

Tests may only be performed by a qualified electrician, or under the supervision and direction of a qualified electrician. The user must be instructed by a qualified electrician concerning performance and evaluation of the test.



Note

Manufacturers and importers of electrical medical devices must provide documentation for the performance of maintenance by trained personnel.

Observe the following safety precautions:

- The instrument may only be connected to TN, TT or IT electrical systems with a maximum of 240 V which comply with applicable safety regulations (e.g. IEC 60346, VDE 0100) and are protected with a fuse or circuit breaker with a maximum rating of 16 A.
- Measurements within electrical systems are prohibited.
- Be prepared for the occurrence of unexpected voltages at devices under test (for example, capacitors can be dangerously charged).
- Make certain that the measurement cables are in flawless condition, e.g. no damage to insulation, no cracks in cables or plugs etc.
- When using a test probe with coil cord (SK2W): Grip the tip of the test probe firmly, for example during insertion into a jack socket. Tensioning at the coil cord may otherwise cause the test probe to snap back resulting in possible injury.
- **Measurement of insulation resistance and equivalent leakage current (alternative leakage current measuring method)**
Testing is conducted with up to 500 V. Current limiting is utilized ($I < 3.5$ mA), but if terminals L or N at the test socket are touched, electrical shock may occur which could result in consequential accidents.
- **Leakage current measurement while connected to line voltage**
It is absolutely essential to assure that the device under test is operated with line voltage during performance of the leakage current measurement. Exposed conductive parts may conduct dangerous touch voltage during testing, and may not under any circumstances be touched. (Mains power is disconnected if leakage current exceeds approx. 10 mA.)



Attention!

The function test may only be performed after the DUT has successfully passed the safety test!

Fuse replacement

The fuses may only be replaced when the instrument is voltage-free, i.e. the instrument must be disconnected from mains supply power and may not be connected to a measuring circuit. The fuse type must comply with the specifications in the technical data or the labeling on the instrument.

Opening the Instrument / Repairs

The instrument may only be opened by authorized, trained personnel in order to ensure flawless operation and to assure that the guarantee is not rendered null and void.

Even original replacement parts may only be installed by authorized, trained personnel.

If it can be ascertained that the instrument has been opened by unauthorized personnel, no guarantee claims can be honored by the manufacturer with regard to personal safety, measuring accuracy, compliance with applicable safety measures or any consequential damages.

If the guarantee seal is damaged or removed, all guarantee claims are rendered null and void.



Attention!

Before opening the housing, pull the mains plug out of the outlet and wait for at least 5 minutes.

Switching Power Consumers – Course of action

Be absolutely sure to adhere to the sequence specified below when switching the live device under test. This prevents excessive wear of the mains relays at the test instrument.

Before measurement:

- 1) **DUT:** Turn the DUT off via its own switch.
- 2) **Tester:** Switch line voltage to the test socket.
- 3) **DUT:** Turn the DUT on via its own switch.

After measurement:

- 4) **DUT:** Turn the DUT off via its own switch.
- 5) **Tester:** Deactivate line voltage to the test socket.

Switching Power Consumers – Maximum Starting current

Our test instruments **SECUTEST BASE(10)**, **PRO** and **SECULIFE ST BASE** allow for the active testing of devices with a nominal current (load current) of up to 16 A.

The test socket of the respective test instrument is equipped with 16 A fuses and the switching capacity of the internal relays also amounts to 16 A. Starting currents of up to 30 A are permissible.



Attention!

In spite of the comprehensive safety measures against overload, **starting currents of more than 30 A** may result in accidental fusing of the relay contacts. In this case, the following error message appears:
„L(N) fuse of the test socket is damaged“.

- ⇒ Check the two fuses of the mains connection. Replace them with new ones if they are damaged.

If the above error message persists, it may be assumed that the relays are damaged. In this case, the test instrument must be sent to our Service Center for repair (address see section 15).

Safer testing with Test Adapter

For devices under test which are expected to feature a starting current of more than 30 A, we strongly recommend the application of a test adapter for higher starting currents:

e. g. test adapter of the AT3 series
(AT3-III E, AT3-IIS, AT3-IIS32, AT16DI or AT32DI).

Alternative: Passive Testing

On the basis of the hazard assessment, it is also possible to perform a passive test (equivalent leakage current method) instead, i.e. without applying line voltage to the test socket.

The test instrument may not be used:

- If external damage is apparent, for example if parts which conduct dangerous touch voltage are freely accessible, if the display is broken or defective (in which case dangerous voltage or mains connection errors might no longer be indicated)
- If the seal or sealing lacquer has been removed as the result of repairs or manipulation carried out by an unauthorized/non-certified service provider.
- With damaged connection and/or measurement cables and patient ports, e.g. interrupted insulation or kinked cable
- If the instrument no longer functions flawlessly
- After extraordinary stressing due to transport

In such cases, the instrument must be removed from operation and secured against unintentional use.

Meanings of Symbols on the Instrument

The symbols on the instrument have the following meanings:



Warning regarding dangerous electrical voltage



Warning concerning a point of danger (attention: observe documentation!)



CE conformity marking



This device may not be disposed of with the trash. Further information regarding the WEEE mark can be accessed on the Internet at www.gossenmetrawatt.com by entering the search term "WEEE".



If the guarantee seal is damaged or removed, all guarantee claims are rendered null and void.

3 General Operation

3.1 Measured Value Display

The following items appear at the display panel:

- The selected measuring function or standard
- Measured values with abbreviations and units of measure
- Setting parameters, i.e. type of connection and measurement type
- Symbols for softkey operation
- Wiring diagrams, notes regarding the test sequence and error messages

Green progress bars appear in the header for single measurements, and orange progress bars appear for test sequences.

If the upper range limit is exceeded, the upper limit value is displayed and is preceded by the ">" symbol (greater than), which indicates measurement value overrun.



Note

The depiction of LEDs in these operating instructions may vary from the LEDs on the actual instrument due to product improvements.

Measured Value Storage

See section 8.4

3.2 Language, Keyboard Layout (culture parameter)

The desired user interface language, a country-specific keyboard layout and a language for the test sequences (measuring sequence parameter) can be selected in the **SETUP** switch setting (see Section 4.3).



Note

If you wish to change the setting of the keyboard layout, you are prompted to scan certain barcodes. This is necessary for the correct functioning of the barcode scanner **after** changing the language. If you do not have the barcode scanner to hand at the moment, you can also adjust the barcode scanner to the new keyboard layout subsequently via Setup (2/3) > External Devices > Barcode Scanner > Type Z751A.

3.3 Help Functions (HELP key and QR code)

Depending on the **rotary selector switch** position and the selected measurement type, appropriate wiring diagrams are displayed.

- ⇨ Press the **HELP** key in order to query online help.
- ⇨ Press the **ESC** key in order to exit online help.

SECUTEST BASE(10): As an alternative, you can download or access current operating instructions from our website with a tablet PC by scanning the QR code with the selector switch set to EXTRA.

3.4 Entering Alphanumeric Characters

Entry via the Keyboard

In addition to the softkey keyboard which can be accessed at the display, USB keyboards (with USB Boot Keyboard Profile) can also be used to enter texts such as offsets, ID numbers, type designations and comments (see also section 5.3).

Reading in Barcodes

- ⇨ Correct recognition of the barcode scanner by the test instrument after connection to the USB port is indicated by the  icon in the header.
- ⇨ Select the following parameter in order to configure the barcode scanner for initial start-up:
Setup (2/3) > External device > Barcode scanner > Type **Z751A**.
- ⇨ Scan the barcode which then appears.

When the menu for alphanumeric entry via the softkey keyboard is opened at the display, any value read in by means of a barcode scanner is directly accepted.

See the appendix in section 14.2 concerning available accessory devices.



Note

We are unable to offer any guarantees regarding the use of scanning devices other than those listed in the appendix.

Reading In an RFID Code

- ⇨ Correct recognition of the RFID scanner by the test instrument after connection to the USB port is indicated by the  icon in the header.

When held at a distance of about 3 cm directly in front of the middle of the RFID tag, the tag's current content is read (e.g. the ID code) and the SCAN LED on the reader blinks.

If the database view (MEM) is active (before or after a measurement), the cursor automatically jumps to the DUT with the corresponding ID code.

If the object is not found, a prompt appears asking if you would like to create a new object.

3.5 Print-Outs – Reports

If you have connected a suitable printer (see list in appendix in section 14.1) via the USB master port, you can print out a test report for each executed single measurement or test sequence by pressing the **PRINT** key. The respective single measurement or test sequence must be previously selected in the memory menu with the help of the scroll keys.



Note

We are unable to offer any guarantees regarding the use of printers other than those listed in the appendix.

3.5.1 Multiprint (only with database extension Z853R or with feature KB01)

If you place the cursor in the memory menu on a test object with several executed tests (individual measurements or test sequences) and press the **PRINT** button, a combined test report is issued with all test results saved for this test object.

3.5.2 Report Template

A report can be generated for the test sequences stored to the instrument. A report template is already included in the test instrument to this end. Depending on which test sequence has been executed, the designation of the standard in the report may change.

The report template includes the following items:

- ID number
- Designation
- Customer name
- Location
- Date
- Time
- Comment with 64 characters
- Standard designation / sequence name / manual test
- Measured values
- Limit values
- Evaluations
- Test equipment (serial number)



Note

The display which appears is not a print preview and does not reflect the actual appearance of the printout.

3.5.3 Report Tapes from Thermal Printers

Report tapes can be printed out with the Z721S thermal printer (accessory: Z722S thermal paper).

Report templates can be created at the PC and uploaded to the test instrument with the help of **Report Designer PC software**. If the test instrument is connected and the respective device under test has been selected, the print preview function generates an accurate preview of the completed report for the connected thermal printer.

4.1.1 Measurements in IT Systems (new parameter as of firmware 1.5.0)



The IT system setting can be activated for all single measurements and test sequences in the **SETUP** switch position (Setup 1/3) in the **All measurements** submenu (in this case the **IT** symbol appears in the header of each display page):

With **“Measurement at IT system” set to Yes**: active leakage current measurements (or all measurements with reference to PE at the mains connection side) are disabled. Test sequences which include measurements of this sort are also disabled.

If, when being connected to line voltage, the SECUTEST detects a change at PE as compared with the previously used mains connection, the inspector is asked directly after initial start-up if the currently used outlet belongs to an IT system. The IT system option in **SETUP** is activated based on the user's answer. If **“Measurement at IT system”** is activated, this is indicated by the **IT** symbol in the header. Regardless of this, it's always possible to accordingly change the option manually in **SETUP**.

The setting for the **“Measurement at IT system”** option is retained even after disconnection from the mains.

Reliable measured values cannot be obtained from active leakage current measurements (or from any measurements with reference to PE at the mains connection side) in IT systems, for which reasons all single measurements of this sort, as well as test sequences which include this type of measurement, are disabled when the **“Measurement at IT system”** option has been activated in **SETUP**.

Parameter **Meas. at IT-mains** can be set in the Setup menu: Setup 1/3 > All measurements > **Meas. at IT-mains**

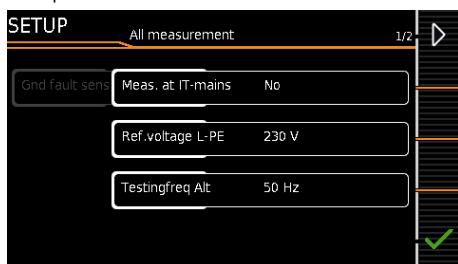

4.1.2 Automatic Recognition of Mains Connection Errors

The device automatically recognizes mains connection errors if the conditions in the following table have been fulfilled. The user is informed of the type of error, and all measuring functions are disabled in the event of danger.

Type of Mains Connection Error	Message	Condition	Measurements
Voltage at protective conductor PE to finger contact (START/STOP key)	Display at the instrument	Press START/STOP button $U > 25 \text{ V}$ → PE key: $< 1 \text{ M}\Omega^2$	All measurements disabled
Protective conductor PE and phase conductor L reversed and/or neutral conductor N interrupted		Voltage at PE $> 100 \text{ V}$	Impossible (no supply power)
Line voltage $< 180 \text{ V} / < 90 \text{ V}$ (depending on mains)		$U_{L-N} < 180 \text{ V}$ $U_{L-N} < 90 \text{ V}$	Conditionally possible ¹
Test for IT/TN system	Display at the instrument	Connection $N \rightarrow PE$ $> 50 \text{ k}\Omega$	Possible under certain circumstances

¹ 10 A R_{PE} measurements are only possible with line voltages of 115/230 V and line frequencies of 50/60 Hz.

² If the user of the test instrument is too well insulated, the following error message may appear: **“Interference voltage at mains connection PE”**



Note

Finger Contact

During this test for correct mains connection, a voltage measurement is performed between the finger contact and PE at the test instrument's mains connection, and its reference potential is acquired via the user's body resistance to the conductive start key. In order to obtain reliable measurement results, this resistance value must be less than 1 M Ω . If the user is wearing insulating shoes or gloves, or is standing on an insulating floor covering, erroneous measurements and display of the **“Interference voltage at mains connection PE”** message may result. Try to reduce resistance in this case, for example by touching ground potential with the other hand (e.g. a radiator, but not an insulating wall etc.).



Attention!

If, while testing protective conductor potential, you determine that **the mains protective conductor is conducting voltage** (in accordance with the first two cases mentioned), **no further measurements may be performed with the test instrument**. If this is the case, potentially dangerous voltage is also present at the accessible earthing contacts of the standard socket (test socket). Immediately disconnect the test instrument from the mains and arrange to have the fault eliminated at the mains connection.



Note

Voltage at the electrical system's protective conductor PE may result in distorted measurement values during testing for the absence of voltage, or during leakage voltage measurements.

4.2 Connecting Test Probe P1 or P2

Insert the double plug from test probe P1 or P2 into socket 1 or 2 respectively such that the plug with the white ring makes contact with the socket with the vertical bar.

The white ring identifies the terminal for the high current conductor which is safeguarded by the neighboring fuse link.



Note

Difficulty in contacting exposed conductive parts when using the standard probe with test tip

In order to assure good contact, surface coatings must be removed from devices under test with special tools at a suitable location.

The tip of test probe P1 is not suitable for scratching away paint, because this may impair its coating and/or mechanical strength. Brush probe Z745G may be more suitable than the test probe in certain individual cases.

4.3 Device Settings

SETUP



For the purpose of **initial start-up**, we recommend setting the following basic parameters in the order shown at the right:

- Setup 2/3 > Culture > **Language** (for user interface)
- Setup 2/3 > Culture > **Keyboard Layout** (for alphanumeric entries)
- Setup 1/3 > System > **Date / Time** (for reports generating)
- Setup 1/3 > System > **Brightness** (display brightness as %)
- Setup 1/3 > Auto. Measurements
> 2/2 > Initial Window Style: **Tree or Detail View**

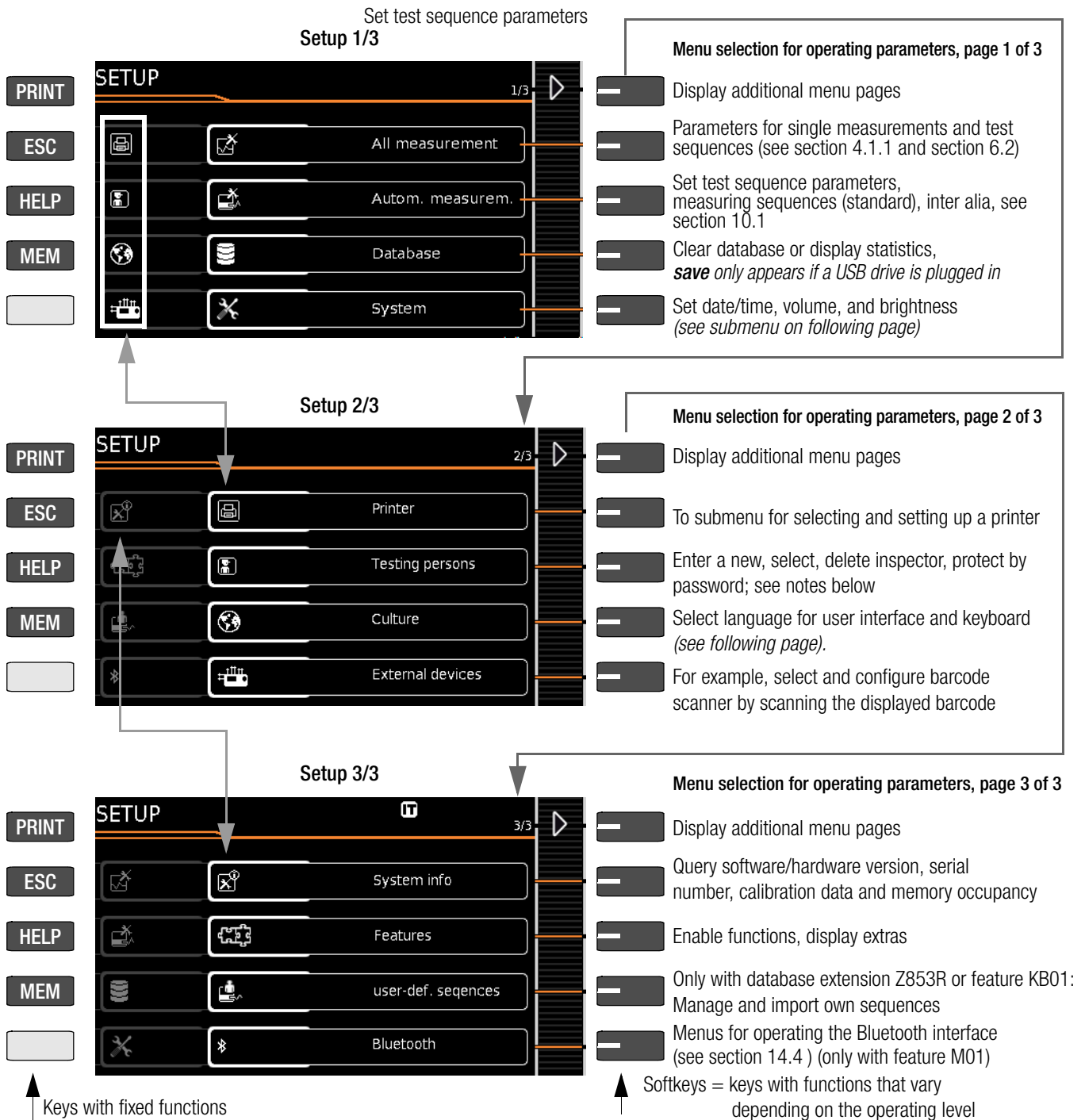

Figure 2: Device Settings, Main Menu Level – SETUP Switch Setting

The following parameters are advisable for **maintenance purposes**:
 SETUP 3/3 > Test > **Display / Buzzer** (for checking info and warning displays/signals)

SETUP 3/3 > System info > **Software version** for updates and **Calibration data** for adjustment, last and next calibration (notes see bottom of page 11).

Notes on Parameter Inspector

- The inspector that has just been “selected” is included in the tests performed as „Inspector“. None of the SECUTEST settings are stored specifically for the inspector – all settings in the SECUTEST are stored for the respective device and are available to **all** inspectors alike.

- **If an inspector is protected by password**, it only prevents those users who do not know the password from “selecting” this inspector. When the test instrument is booted up, the password is **not** requested. The inspector remains selected even in the event of a power failure – a (password-protected) inspector can only be rejected by selecting another inspector.
As of firmware 1.6.0: In order to delete an inspector whose password you do not know, it is sufficient to enter an incorrect password five times and to confirm the entry each time. Subsequently a query is issued as to whether the inspector is to be deleted. The inspector to be deleted may not be identical with the currently selected inspector.

Setup 2/3 > Culture

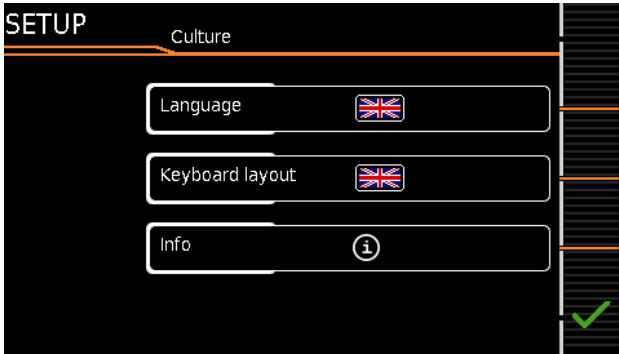

Manual selection for language and keyboard layout

- Page 2/2: Info on date format, decimal separator
- Select language for user interface
- Country-specific keyboard layout for USB or touch-screen keyboard
- Info: date format, decimal separator *
- Jump back to next higher menu level

Setup 1/3 > System 1/2

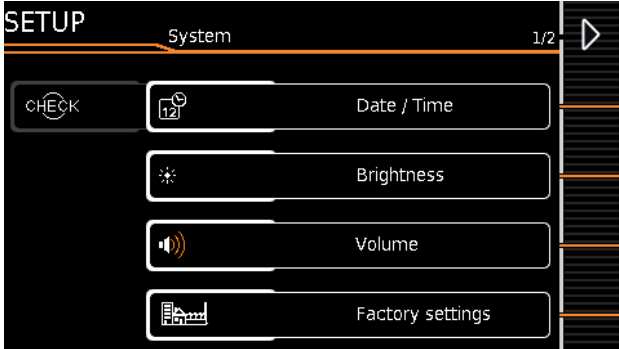

Menu selection for date, volume and brightness

- To parameter for default values
- Date and time setting menu (see settings menu below)
- Brightness setting menu for LCD
- Volume setting menu
- messages, user interface, measurements
- Reset to default values
- **CAUTION !** The setup configurations are deleted! (The database including structure and measured values is preserved.)

Setup 1/3 > System 2/2 > Default Settings

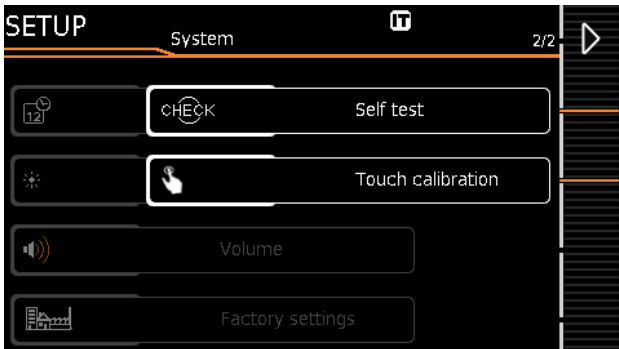

Default Settings

- To parameters
- Self-test for display and buzzer
- With SECUTEST PRO only (feature E01): calibrate touch-screen keyboard

Setup 1/3 > System 1/2 > Date / Time

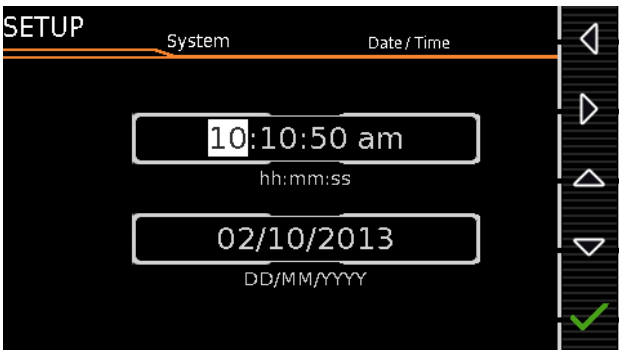

Set Time and Date Menu

- Move cursor left
- Move cursor right
- Increase number
- Decrease number
- Accept changes and jump back

Figure 3: Device Settings, Submenu Level – SETUP Switch Setting

Notes on Calibration Data (Adjustment, Calibration)

SETUP 3/4 > System info 2/6 > **Calibration data:**
 While the data of the last adjustment and calibration were set by the calibration center, the date and time of the next calibration

(date of recalibration) can be modified by the user, if necessary, by selecting the **EDIT** button, as shown in the example above for setting the system time.

* firmware version 1.7.0 and higher contains the parameter „Measuring Sequences“ for the selection of country-specific standards (VDE, OVE and NEN) in SETUP 1/3 under menu item „Auto measurements 2/2“.

Setup 1/3



Database 1/2

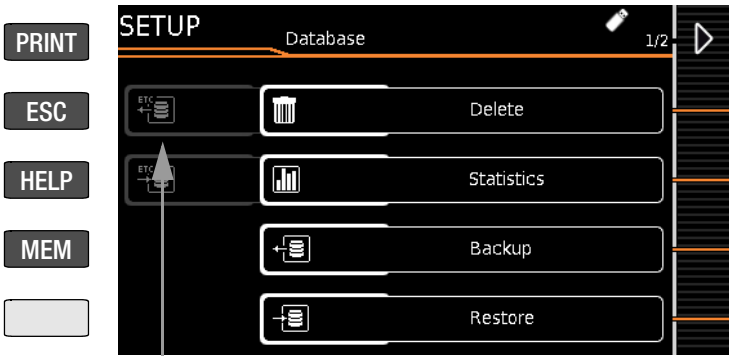

Menu selection for database functions, page 1 of 2

- Display additional menu pages
- Delete database content (but not its structure)
Caution: Data are irretrievably deleted!
- Display database
- Only with inserted USB drive:
backup database to USB flash drive (FAT formatted)
- Only with inserted USB drive:
restore database from USB flash drive

Database 2/2



Menu selection for database functions, page 2 of 2

- Display additional menu pages
- Only with database extension* and inserted USB drive: export database in ETC format for ETC
- Only with database extension* and inserted USB drive: import database in ETC format from ETC

* Z853R or feature KB01

Keys with fixed functions

Softkeys = keys with functions that vary depending on the operating level

5 Internal database

5.1 Creating Test Structures, General

A complete test structure with data regarding customer buildings, floors, rooms and devices under test can be created in the test instrument. This structure makes it possible to assign single measurements or test sequences to devices under test belonging to various customers. Manual single measurements can be grouped together into a so-called "manual sequence".

Objects can be identified with the following parameters:

- **DUT (ID, designation, type, manufacturer, serial number, comment, cost center*, department*)**
- **Room* (ID and designation)**
- **Floor* (ID and designation)**
- **Building* (ID, designation, street, ZIP code and city)**
- **Property* (ID and designation)**
- **Customer (ID, designation, street, ZIP code and city)**

* only with database extension Z853R or with feature KB01

Key

ID = identification number

5.2 Transmitting and Saving Test Structures and Measurement Data

The following functions are possible (as far as the test instrument is concerned):

- **Export:** Transfer a structure including measured values from the test instrument to the PC (ETC) (see section 5.2.1).
- **Import*:** Transfer a distributor structure from the PC (ETC) to the test instrument (**SECUTEST PRO** only) (see section 5.2.2).
- **Backup*:** Backup a database to a USB flash drive (FAT formatted, not NTFS) plugged into the test instrument (see section 5.2.3).
- **Restore*:** Restore a database to the test instrument from a USB flash drive (FAT formatted, not NTFS) plugged into the test instrument (see section 5.2.3).
- **Reports:** Save reports to a USB flash drive (see section 3.8).

* only with database extension Z853R or with feature KB01

If no USB flash drive has been plugged in, the above listed functions are displayed in gray and are disabled.

In order to transfer structures and data, the test instrument and the PC must be connected with a USB cable or a USB flash drive must be available.

Please observe the following safety precautions:



Attention!

During data transmission via the USB port (USB connection to the PC or connection of a USB drive), neither the interface cable nor the USB drive may be disconnected.



Attention!

The test instrument may not be disconnected from supply power during transmission via the USB port. The memory structure in the test instrument might otherwise be destroyed.



Note

Data transfer to the PC (ETC) should not be started during single measurements or test sequences.

5.2.1 Export – Transmitting Test Structures and Measurement Data from the Test Instrument to the PC

Structures set up in, and measurement data saved to the test instrument can be exported to ETC report generating software via a connected USB flash drive (only with database extension Z853R or with feature KB01), or via the USB slave port. Select **Export ETC file** under Setup > Database 2/2 to this end. The data are converted to an ETC-compatible format with the "etc" file extension.

ETC is started at the PC by double clicking the exported file and the data are read in. Data can then be saved to the PC and reports can be generated.

The most up-to-date version of ETC report generating software can be downloaded free of charge from the **mygmc** page of our website as a ZIP file, if you have registered your test instrument:

<http://www.gossenmetrawatt.com>

→ Products → Software → Software for Testers → Report Software without Database → ETC → [myGMC](#)

5.2.2 Import – Uploading Test Structures Created in ETC to the Test Instrument (only with database extension Z853R or with feature KB01)

As an alternative, a test structure can be created at the PC with the help of ETC software and then transferred to the test instrument via a connected USB flash drive or via the USB slave port. Select the **Import ETC file** function to this end under Setup > Database 2/2. The ETC data are converted to a format which is compatible with the test instrument.

A complete description of database creation can be found in the online help included with ETC software.

The same safety precautions apply here as was also the case in the section covering export.

5.2.3 Backing Up and Restoring Test Structures and Measurement Data

Structures created and measurement data saved at the test instrument can be backed up via an inserted USB flash drive (FAT formatted, not NTFS). Select the **Backup** function to this end under Setup > Database 2/2. The test instrument creates a DATABASE directory at the USB flash drive (if it doesn't already exist) and generates a backup file.

Up to firmware 1.5.4:

If there's already a backup file in this directory, you're asked if it should be overwritten. A new backup with the same name is only create if you respond to the prompt in the affirmative with the  icon.

As of firmware 1.6.0:

The backup files on the USB stick are named by means of a time stamp (file extension: .etcbak).

In order to restore structures and data from an inserted USB flash drive, select the **restore** function under Setup > Database 2/2. The test instrument accesses the backup file automatically.



Note

Backup/Restore to/from USB Flash Drive

Firmware 1.7.2: Backups can only be restored within the same firmware revision level. If the firmware has been updated between backup and restoring, the database is no longer valid.

As of firmware 1.8.0: It is also possible to restore backup files created with previous firmware versions.

Test Structure – Hierarchy of Object Levels in the SECUTEST BASE(10)

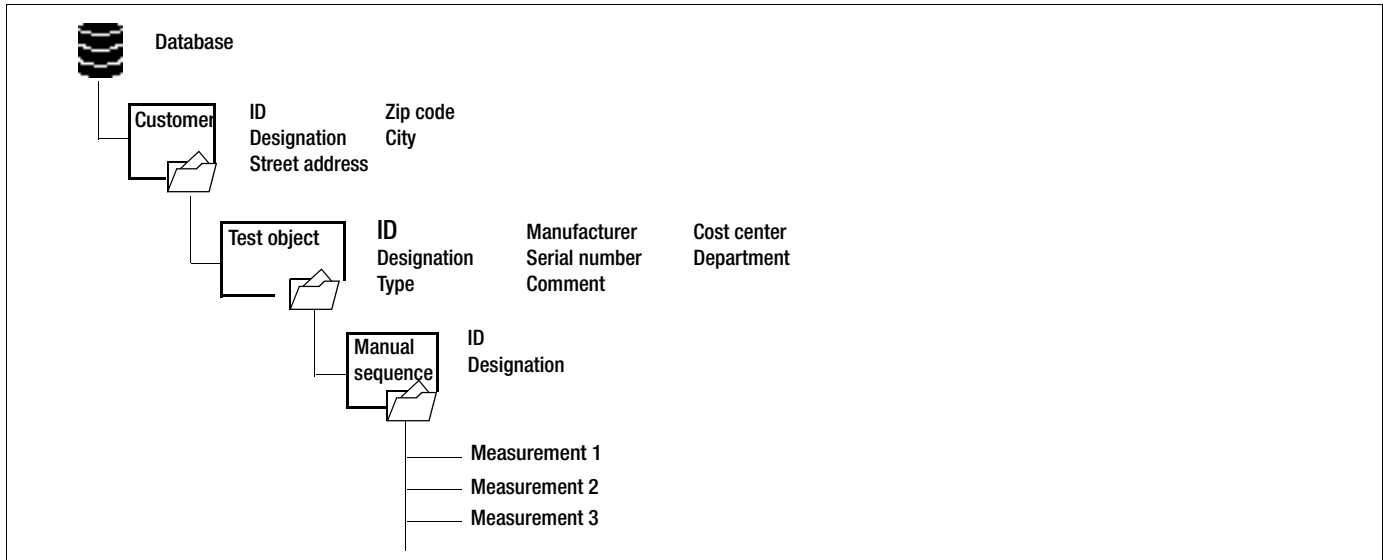

Figure 4: Database Structure

Test Structure – Hierarchy of Object Levels in the SECUTEST PRO or with database extension Z853R or with feature KB01)

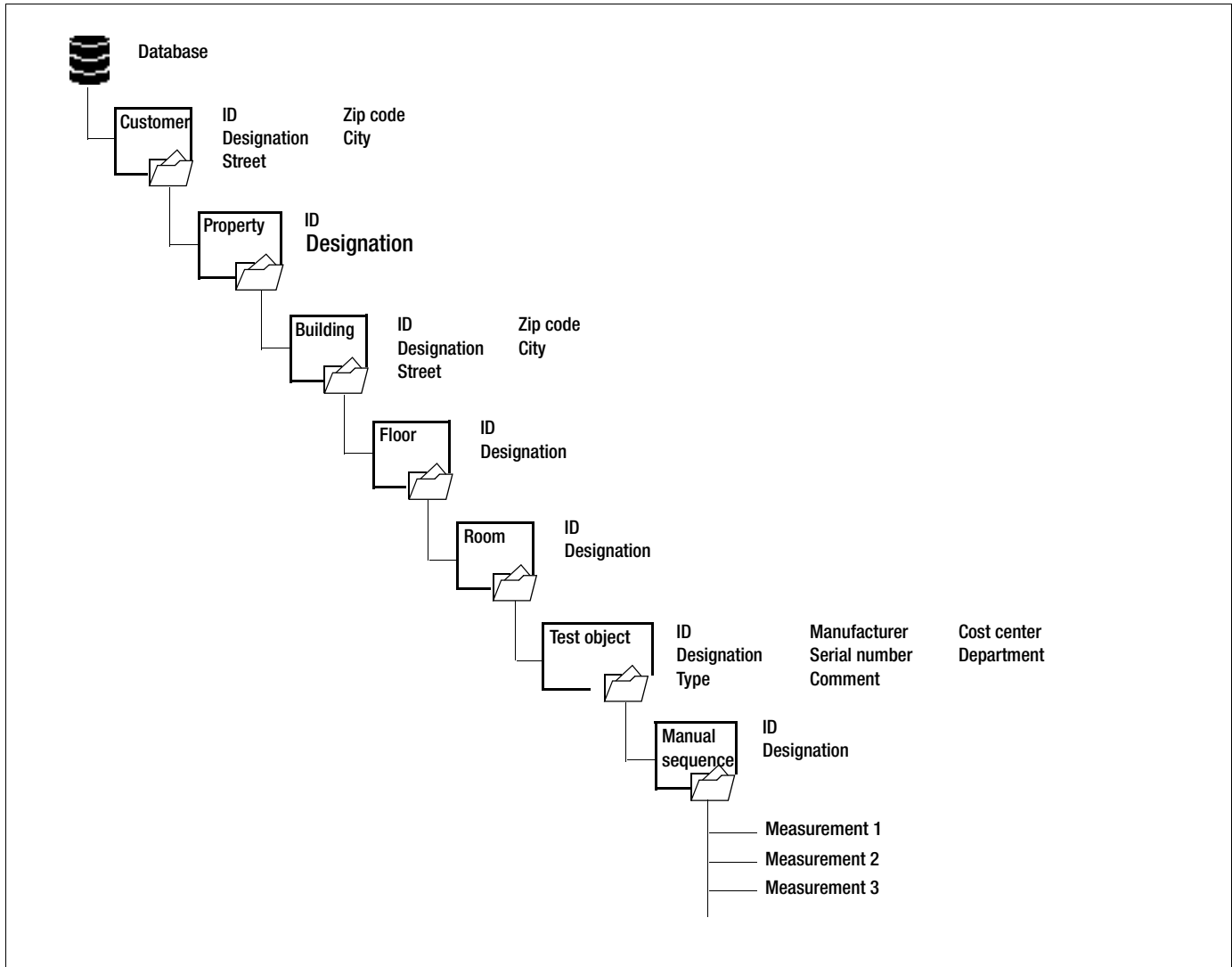

Figure 5: Database Structure in Test Instruments with feature KB01

5.3 Data Entry

Overview of Keyboard Entries Via the Softkeys with the SECUTEST BASE(10)

Switch between keys and display panel				Delete characters from right
Exit entry function without saving				Switch between upper/lowercase, and symbols
Scroll up				Scroll right
Scroll down				Scroll left
Transfer character at cursor to display field				Accept entry

Overview of Keyboard Entries via the Touch-Screen Keyboard with the SECUTEST PRO (feature E01)

<ul style="list-style-type: none"> One-time brief pressing of the shift key switches to capitalization for the following character. Pressing the shift key for a longer time switches to permanent capitalization. By pressing the display panel at a certain point in the existing text, you can position the cursor as you like. 		<p>* Also via assigned softkey</p> <p> Delete characters from right*</p> <p> Accept entry*</p>
---	--	--

5.3.1 Keyboard Entries via Softkeys or External Keyboard

After selecting ID or any other object parameter, a keyboard is displayed which allows entry of alphanumeric characters via the fixed function keys and the softkeys. Alternatively, entries can also be made with the help of a USB keyboard or a barcode scanner which is connected to the instrument.

The keyboard layout can be matched to the language in SETUP. SETUP 2/3 > Culture > **Keyboard Layout** (for alphanumeric entries)



Note

In order to operate an external USB keyboard successfully at the SECUTEST..., it is imperative that the settings for the keyboard layout which have been entered in the setup for "keyboard layout" conform to the connected keyboard.

Procedure (example: enter a DUT designation):

- Switch the keyboard to uppercase, lowercase or special characters with the abc key (Abc, ABC, Symb).
- Select the desired alphanumeric character or a line break with the scroll keys (left, right, up and down).
The selection cursor can be accelerated by pressing and holding the respective scroll key.
- After pressing the key, the respective character appears in the display field.
- Repeat steps 1 through 3 until the complete designation is shown in the display field.
- The designation in the display field can be changed subsequently after hiding the bottom keyboard by pressing the key. The cursor position can then be changed in order to delete individual characters.
- After pressing the green checkmark, the selected character string is saved.

5.3.2 Data Entry via Touch-Screen Keyboard (only with SECUTEST PRO or instrument with feature E01)

The touch-screen keyboard permits convenient entry of data and comments, selection of parameters and direct parameter selection, and menu-driven operation is still possible via the softkeys as an alternative.

Meaning of Symbols in the User Interface – Database Management

Symbol	Meaning
Main Level	Sub-Level
	Memory menu, page 1 of 3
	Change display to menu selection
	UP key: scroll up
	DOWN key: scroll down
	RIGHT key: open tree
	LEFT key: close tree
	Memory menu, page 2 of 3
	Change display to menu selection
	Add a structure element
	Delete selected structure element or measurement
	Edit DUT: ID, designation or type
	When selecting a measurement: display measured values
	Display details from the measurement results list
	Hide details from the measurement results list
	Memory menu, page 3 of 3
	Change display to menu selection
	Search for ID number or text > enter complete ID number (ID) or text (complete word)
	Search for ID number > Enter complete ID number
	Confirm search results
	Display the structure designation
	Hide the structure designation

5.4 Creating a Test Structure in the Test Instrument, Navigating within the Structure and Displaying Measured Values

Overview of the Meanings of the Symbols for Creating Objects – Navigation within Test Structures

MEM 1/3

Object selection menu – page 1/3

- Scroll to next menu (page 2/3)
- Select customers or DUTs
- Select customers or DUTs
- Jump back (one hierarchical level higher) or close opened branches
- Select customers or DUTs

MEM 1/3

Measurement selection menu – page 1/3

- Scroll to next menu (page 2/3)
- Selection of measurements
- Selection of measurements
- Jump back (one hierarchical level higher) or close opened branches
- Display measured values for a selected test

1: Test sequence per standard (symbol: orange)
2: Single measurement (symbol: green)

MEM 2/3

Object editing menu – page 2/3

- Scroll to next menu (page 3/3)
- Add new DUT to a selected customer
- Delete selected DUT or measurement
- Edit DUT/customer

MEM 3/3

Object search menu – page 3/3





- Scroll to next menu (page 1/3)
- Search all database objects in the ID and designation fields
- Search for DUTs via ID
- Display designation and ID of the selected DUT

Figure 6: Overview of Navigation, Object Editing and Object Search in the Database



5.4.1 General Procedure for Creating Test Structures

After selection with the **MEM** key, all setting options for the creation of a tree structure are made available on three menu pages (1/3, 2/3 and 3/3). The tree structure consists of structure elements, referred to below as objects.



Selecting the Position at which a New Object will be Added

- Use the  or  key in order to select the desired structure elements.
- If a sublevel exists, you can switch to it by pressing the  key, or you can open a branch.
- The open branch is then closed, or you can switch to the next higher hierarchical level, by pressing the  key.



Creating a New Object

- Scroll to the second menu page (MEM 2/3) with the help of the  key.
- After pressing **NEW**, a new object or DUT can be created. Depending on the current position within the hierarchy, the respectively available object types are suggested. Depending on the object type, you'll have to enter at least an ID number via the keyboard. If not all of the mandatory entries (identified in red) are completed, an error message appears.
- Then press the green checkmark in order to accept the entered values. The display jumps back up to the higher hierarchical level. 

Changing the Description or ID Number of a Previously Created Object

- Scroll to the first menu page (MEM 1/3) with the help of the  key.
- Select the structure element whose designation will be changed.
- Scroll to the second menu page (MEM 2/3) with the help of the  key.
- Press the **EDIT** symbol.
- Select the parameter whose description will be changed. The keyboard appears automatically.
- Change the displayed designation and acknowledge your entry.

5.4.2 Searching for Structure Elements

- Scroll to the first menu page (MEM 1/3) with the help of the  key.
- Mark the structure element from which the search will be started.
- Scroll to the third menu page (MEM 3/3) with the help of the  key.
- Press the text symbol in order to search for text.
- Press the ID symbol in order to search for an ID number. There are three ways to enter search terms:
 - Via the softkeys
 - Via a connected USB keyboard
 - Via barcode or RFID scanner

The keyboard entry function is opened automatically in any case.

- The search is started after the entered search term has been acknowledged.







Note

Only exact matches are displayed: no wildcards, case sensitive.

The found object is displayed inversely.

- The designation and ID number can be shown or hidden by pressing the magnifying glass symbol.

5.4.3 Displaying Measured Values from Saved Tests

- Switch to the database view by pressing the **MEM** key.
- Scroll to the first menu page (**Navigation**) (**MEM 1/3**) with the help of the  key.
- Either select the desired DUT (ID number) with the scroll keys or search for it as described in Section 5.4.2.
- Then mark the desired test with the cursor, depending on whether single measurements or test sequences are involved:
Single meas.: **date / measuring function** (7/17/14 / RISO)
Test sequence: **date / test standard** (7/17/14 / VDE...)
- In order to view the single measurements of a test sequence after testing, press the symbol for executed measurements. The measurements appear in a list. 
- Select the desired measurement with the scroll keys. 
- The associated measuring parameters can be shown or hidden using the keys shown at the right. 
- The measured value view is exited by pressing the green checkmark.

5.4.4 Backing Up and Restoring the Database

The database can be saved to a USB flash drive (FAT formatted, not NTFS) which is plugged in directly to the USB master port at the test instrument (see SETUP 1/3 > Database > Backup).



Attention!

During data backup via the USB port (USB connection to the PC or inserted USB drive), neither the interface cable nor the USB drive may be disconnected. If the USB drive is removed during the backup it may be rendered defective.



Attention!

The test instrument may not be disconnected from supply power during data backup via the USB port.

Restoring the Database – RESTORE

If the database in the test instrument has been inadvertently deleted, a database version which has been saved to a USB drive (FAT formatted, not NTFS) can be restored to the instrument.



Note

Restoring a database from a USB drive is only possible if the firmware revision level is unchanged. If the firmware has been updated between backup and restoring, the database is no longer valid and cannot be used.

5.4.5 Deleting the Database

The database in the test instrument can be deleted in two different ways:

- SETUP** switch setting, page 1/3 > Database > **Delete**
- Press the **MEM** key > scroll up with the scroll key until the database is selected > press the **DEL** softkey.

6 Connecting the Device Under Test

- Connect the DUT in accordance with the schematic diagrams included in the online help function.

Connection of the DUT to the test instrument depends upon:

- **The type of DUT:**

For direct connection to the test socket (TS)

Devices with single-phase connection, as well as extension cords via the **EL1** adapter (in which case the EL1 is connected to probe sockets P1)

For permanent connection (to the mains)

By contacting the housing with the probe (for the measurement of protective conductor resistance or with the direct measuring method for the touch current measurement)

For connection via adapter

- With *single-phase extension cords* via the **EL1** adapter (in which case the EL1 is connected to probe sockets P1)
 - With *single and 3-phase extension cords* via the **VL2E** adapter to the test socket
 - Devices with 5-pole, 16 A CEE plug via the **AT16-DI** differential current adapter to the test socket
 - Devices with 5-pole, 32 A CEE plug via the **AT32-DI** differential current adapter to the test socket
- **DUT protection class** (PC I, PC II or PC III) or any combinations of protection classes



Note

The DUT must be switched on for all tests. Switches, relays, temperature regulators etc. must all be taken into consideration.

The test instrument automatically recognizes whether or not the DUT is connected to the **test socket** or the **voltage measuring inputs** (option). As a default setting, the program sequence assumes that the plug from the DUT has been connected to the test socket.

6.1 Residual Current Monitoring

For your safety, the test instrument is equipped with continuous residual current monitoring. If residual current exceeds a specified limit value, all measuring processes are stopped, and if line voltage is fed through the test socket it's disconnected. This limit value can be set to one of two levels in the **SETUP** switch position: Setup 1/3 > All Measurements > Residual Current Protection > **10 mA/30 mA**

6.2 Specifying Reference Voltage L-PE and Test Sequence Alternative

The reference (line) voltage is the voltage to which the measured values for leakage current have been standardized. It is used for the arithmetical adjustment of current measuring values of leakage current to the specified voltage.

Measurements with line voltage at the test socket: The setting value has no influence on the voltage the DUT is supplied with via the test socket of the SECUTEST.

Leakage current measurements with „Alternative“ method: The set-point value of the synthetic test voltage is derived from the value specified here.

Reference voltage can be adjusted in setup:

Setup 1/3 > All Measurements > **Ref. Voltage L-PE**

Defining Test Frequency „Alternative“

Variable frequency setpoint value for synthetic test voltage for all leakage current measurements of measurement type „Alternative“, affecting the following measurements and/or rotary selector switch positions:

- individual measurements (green rotary switch level)
- measurements in test sequences predefined ex factory
- measurements in user-defined test sequences (only with database extension Z853R or feature KB01)

Parameter **Test freq. Alt.** can be configured in the Setup: Setup 1/3 > All measurements > **Test freq. Alt.**

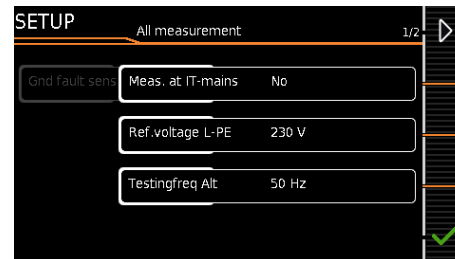

6.3 Manually Specifying the Connection Type for Single Measurements

If the test instrument is unable to detect the respective **connection type** (e.g. test socket or permanent connection (voltage measuring inputs)), the suggested connection type must be examined and the connection type must be specified manually if necessary.

- Select **parameter settings**.



- After selecting the **measurement type** parameter, a list of possible connection types is displayed.
- Select a **connection type**.

Once a connection type has been selected, it remains active for all following tests until it's changed once again.

6.4 Manually Selecting a Connection Type / Protection Class for Automatic Test Sequences

If the test instrument is unable to detect the respective connection type or protection class, the suggested connection type must be examined and the connection type or protection class must be specified manually if necessary.

- Press the **SEL** key shown at the right in order to display the **classific. parameters**.



- After selecting the **protection class** or **connection type** parameter, a list of possible settings is displayed.
- Select the respective parameter.
- Acknowledge the **Class. Param.** (classification parameters) once again.

The connection type appears at the middle of the header. The symbol for the respective protection class appears to the right of the connection type.

Once a connection type or a protection class has been selected, it remains active for all following tests until it's changed once again.

6.5 Special Conditions



Note

Protection Class II Devices with Protection Class I Mains Plugs

If the device under test is equipped with a protection class I plug although it complies with protection class II, protection class I is recognized by the test instrument. If this is the case, switch the protection class parameter from I to II.

Testing Several Protective Conductor Connections with the Function for "Automatic Detection of Measuring Point Changes"

During protective conductor measurement, the test instrument recognizes whether or not test probe P1 is in contact with the protective conductor, which is indicated by means of two different acoustic signals.

This function can be adjusted in the **SETUP** switch position in the "Auto Measurements" submenu via the "Auto Measuring Point" parameter.

Protective Conductor and Insulation Resistance Measurements for Permanently Installed Devices Under Test



Attention!

Deactivate the electrical system which supplies power to the device under test before connecting the test instrument!

- Remove the mains fuses from the device under test and disconnect neutral conductor N inside the device under test.

Touch Current Measurement (absence of voltage)

Make sure that the contacted parts are not grounded.

6.6 2nd Test Probe (only SECUTEST PRO or feature H01)

If the device under test is not equipped with a country-specific mains plug which fits into the test socket at the SECUTEST, or if a permanently installed DUT is involved, the second test probe, in combination with the first test probe, permits 2-pole measurement (dual-lead-measurement) of RPE, RISO and equivalent leakage current.

Measurements with test probe 1 against test probe 2 (P1 – P2) are electrically isolated from the mains. There's no voltage at the test socket.



Attention!

Please note that during insulation measurement the maximum test voltage of 500 V may be applied between the probes.

6.7 Connection Prompts

If a single measurement (green rotary switch positions) or a specific (integrated) automated test sequence (orange rotary switch positions) is started, checking is conducted to determine whether or not all of the probes and measurement cables required to this end are connected (depending on the configuration level of your SECUTEST...). If this is not the case, you're prompted to connect probes, measurement cables or the test adapter to the SECUTEST....

Checking is only conducted to determine whether or not the corresponding sockets are occupied – make sure that suitable accessories have been connected for the selected measurement/connection type.

A list of possible DUT connections depending on type of measurement is included in section 11.2.

6.8 Connection Tests Conducted by the Test Instrument

The following measurements are performed automatically when the DUT is connected to the test instrument.

- Detection of Probes / Measurement Cables**
During individual measurements / automated test sequences, checking is conducted to determine whether or not the measuring sockets required for the measurement/sequence are occupied.
- DUT connection detection** (only with country-specific variant*)
With the rotary switch in the AUTO/A1-A8 position, the "Test Socket" connection type is selected automatically (if correspondingly configured), if a mains plug is detected in the test socket.
- Protection class detection** (with country-specific version only *):
With the rotary switch in the AUTO/A1-A8 position, protection class I or protection class II is selected automatically (if correspondingly configured), depending on the detected type of mains plug.
- Short-Circuit Test**
Before switching mains voltage to the device under test: test for short-circuiting between L and N or L/N and PE. If applicable additionally as "inspection test step" in automated test sequences.
- On test** (test of whether the device under test is switched on or off)

Automatic Recognition of States when Connecting DUTs and Probes

Control Function	Condition	
Short-circuit test	Short-circuit / starting current	$R \leq 2,5 \Omega^{**}$
	No short-circuit (AC test)	$R > 2,5 \Omega^{**}$
Open-Circuit Voltage U_0 4.3 V, Short-Circuit Current $I_k < 250$ mA		
On test	On (passive DUT)	$R < 250$ k Ω
	Off (active DUT)	$R > 300$ k Ω
Open-Circuit Voltage U_0 230 V AC, Short-Circuit Current $I_k < 1,5$ mA		
Special test	No probe	$R > 2$ M Ω
	Probe detected	$R < 500$ k Ω
Protection class detection (only for country-specific (earth-contact) plug variant)*		
	Protective conductor exists: PC I	$R < 1 \Omega$
	No protective conductor: PC II	$R > 10 \Omega$
Safety shutdown		
Triggered at following residual current value (selectable)	> 10 mA / > 30 mA	
Triggered at following residual current values (selectable)		
During leakage current measurement	> 10 mA	
During protective conductor resistance meas.	> 250 mA	
Connection test (only for country-specific (earth-contact) plug variant)*		
Checks whether the DUT is connected to the test socket.		
	Power line of DUT exists	$R < 1 \Omega$
	No power line of DUT	$R > 10 \Omega$
Insulation test		
	DUT set up in a well-insulated fashion	$R \geq 500$ k Ω
	DUT set up in a poorly insulated fashion	$R < 500$ k Ω
PELine – PCTestsocket: Open-Circuit Voltage U_0 500 V DC, $I_k < 2$ mA		
Overcurrent protection (shutdown)		
Shutdown in the event of a continuous flow of current via the test socket:	$I > 16,5$ A	
Our test instruments SECUTEST BASE(10) and PRO allow for the active testing of devices with a nominal current (load current) of up to 16 A. The test socket of the respective test instrument is equipped with 16 A fuses and the switching capacity of the internal relays also amounts to 16 A. Starting currents of up to 30 A are permissible. For devices under test which are expected to feature a starting current of more than 30 A, we strongly recommend the application of a test adapter for higher starting currents: e. g. test adapter of the AT3 series		

* applies to M7050 with feature B00, B09 and B10

** applies as from version 1.7.0;

previous condition $\leq 1.5 \Omega$ or $> 1.5 \Omega$, respectively



Attention!



* Safety Shutdown

As of 10 mA of differential current (can also be set to 30 mA), automatic shutdown ensues within 100 ms. This automatic shutdown does not take place during leakage current measurement with current clamp sensor or adapter!

7 Notes on Saving Single Measurements and Test Sequences



At the end of each test, test results can be saved under an ID number which is unequivocally assigned to the respective DUT. Depending on the initial situation, i.e. whether or not a test structure or database is already available or an ID has already been entered, the following different procedures are used for saving:

Variante 1 – pre-selection of an existing ID

You've already set up a test structure in the test instrument or uploaded one with the help of ETC report generating software. Open the database view before starting the measurement by pressing the **MEM** key. Then select the device under test or its ID within the test structure by pressing the respective scroll key. Exit the database view (MEM navigation) by pressing **MEM** and start the measurement. Press the "Save as" key  at the end of the measurement. The display is switched to the SAVE view. The ID appears with a green or orange background. Press the save  key once again in order to complete the procedure.

Variante 2 – entry of an existing ID at the end of the test









You've already set up a test structure in the test instrument or uploaded one with the help of ETC report generating software. You perform the measurement without first opening the database. No device under test was previously selected in the database. Press the "Save as" key  at the end of the measurement. The following message appears: "No DUT selected!" Press the **ID** key. The softkey keyboard appears.

If you enter an ID here which is already in the database, the database view appears (MEM navigation) automatically, and the DUT's ID is displayed inversely. Acknowledge the entry by pressing the  key. The display is switched to the SAVE view. The ID appears with a green or orange background. Press the Save  key once again in order to complete the procedure.

Variante 3 – entry of a new ID at the end of the test

You haven't yet set up a test structure in the test instrument, or the ID is not included in the existing structure. Press the "Save as" key  at the end of the measurement. The following message appears: "No DUT selected!" Press the **ID** key in order to enter the DUT's ID. The softkey keyboard appears.

If you enter an ID here which is **not yet** included in the database, a prompt appears asking you if you want to enter a new object.

- : If you press , the display is switched to the SAVE view. The ID appears with a green or orange background. Press the save  key once again in order to complete the procedure.
- : If you press , the database view appears (MEM navigation). Go to the next page (**Edit objects 2/3**) by pressing , and then enter a new object. Press  to this end. All possible object types are displayed. Press "DUT". The newly entered ID appears in red to the right of the ID parameter. Acknowledge the entry by pressing the  key. The display is switched to the database view (MEM navigation). The newly entered device under test is displayed inversely in the structure. Press **MEM** in order to return to the SAVE view. The ID appears with a green background. Press the save  key once again in order to complete the procedure.
- **ESC**: If you don't want to save any measured values, press **ESC** twice in order to go to the measuring view. If you press **ESC** again, a prompt appears asking whether or not you want to delete the measuring points in order to continue with the measurement without saving.

8 Single Measurements

8.1 General

- The desired measurement is selected with the help of the green pointer on the rotary switch and the green semicircle.
- The respective measurement is configured with the help of the softkeys. The parameter settings can be accessed by pressing the softkey with the symbol shown at the right.
- The **measurement type** parameter displayed in each case in the footer can be changed directly using the key shown at the right without having to exit the measuring view.
- The selection of **polarity** for line voltage at the test socket can be changed directly using the key shown at the right without having to exit the measuring view.
- No limit values can be specified for single measurements, and thus there is no evaluation.

- Checking is performed before each measurement in order to assure a trouble-free sequence, and to prevent any damage to the DUT.
- Single measurements can be saved to memory. The assignment of an ID number is possible to this end.
- Single measurements can be combined into measurement series.
- Mains power can be connected to the DUT with the desired polarity by making a pre-selection in the parameter settings.

Measurement Status – Progress Bar

Measurement standstill (static line)



Measurement in progress (space is gradually filled in, pulsating)

Measuring View, Single Measurements

Current measured value

PRINT ESC HELP MEM

Measurement: - Start - Stop

Measurement/connection type: PE(Mains) - P1

Offset: 1 mΩ

Test current: IP(set) ±200 mA =

Select parameters, Selecting measurement/connection type, Adjust test current, Rest offset to 0 Ω, CLEAR OFFSET

Measuring Parameters Display, Single Measurements

Current/maximum number of parameter pages: 1/1

PRINT ESC HELP MEM

ESC: discard change and jump back to measuring view

Parameter: Mode PE(TS) - P1, IP(set) ±200 mA =, Offset 0 mΩ

Selectable parameter, Selected parameter value

Scroll through parameter pages, Select measuring parameter directly, Accept changes and jump back to measuring view

Numeric Entry (for parameters UIISO(set), Offset ...) via Softkeys with the SECUTEST BASE(10)

Display keyboard > select/acknowledge digits / hide keyboard > edit display value

Discard entry and exit keyboard

Scroll up

Scroll down

Accept character at cursor position

Parameter: Offset

0.000

≤ 2.00 Ω, ≥ 0 mΩ, Unit: Ω

7 8 9, 4 5 6, 1 2 3, - 0 .

Delete character to left of the cursor in display, Scroll right, Scroll left, Accept entry and exit keyboard

Numeric Entry (for parameters UIISO(set), Offset ...) via Touch-Screen Keyboard with the SECUTEST PRO (feature E01)

* Also via assigned softkey

Parameter: Offset

0.000













≤ 2.00 Ω, ≥ 0 mΩ, Unit: Ω

7 8 9, 4 5 6, 1 2 3, - 0 .







Delete character to the left of the cursor in the display, Accept entry and exit keyboard *

Figure 7: Configuring Single Measurements (parameters entry and display)

8.2 Meaning of Symbols in the User Interface

Symbol	Softkey Variants, Single Measurements
	Set parameters
	Accept changed parameters, acknowledge memory location
	Acknowledge messages during tests/measurements or resume test sequence
	Abort measurement
	Direct selection key for selecting the measurement type
	Currently selected polarity: "L-N" Press key to change polarity
	Currently selected polarity: "N-L" Press key to change polarity
Ip	Direct selection key for selecting test current for protective conductor measurement
U+ U-	Direct selection key for changing voltage in 10 V steps for insulation measurement
	Start evaluation – record measured value. Each time this softkey is pressed, an additional measured value is saved and the number is increased by one.
ID	The ID number to which the measurement(s) will be stored can be entered here.
	Valid measured values have been obtained for a measurement. This measurement can be saved.
	Save measurement data as (with display of directory path / ID or new entry of an ID other than the preselected one)
	Display measured values from performed measurements
	Magnifying glass symbol: show (+) or hide (-) details regarding database objects or selected measurements





8.3 Displaying the Last Measured values

- Start the measurement by pressing the **START/STOP** key. The symbol shown at the right appears and indicates how many measurements have already been performed. 
- Stop the measurement by pressing the **START/STOP** key, unless a specified measuring time has been stipulated. The save symbol (floppy disk with a number 1) appears and indicates that one valid measured value has been recorded, which can now be saved. 
- Press the **save icon** (floppy disk). "No DUT selected!" appears. 
- In order to view the last measured values, press the symbol for executed measurements after testing. The last measured values are displayed. 
- The desired measurement can be selected with the scroll keys. 
- The associated measuring parameters can be shown or hidden using the keys shown at the right. 
- The measured value view is exited by pressing the green checkmark, in order to subsequently save the measured values (as described in Section 8.4) or to return to the initial view by pressing the ESC key.





8.4 Measurement Series and Storage

Single measurements can be combined into measurement series. The measured values can be saved by pressing the save key, or measurement series can be generated. These can be saved to a DUT (ID number) which has already been set up in the database (see Section 5.4.1). The appearance of the save key changes depending on meaning.

Measuring Sequence with Pre-Selection of the DUT

- Activate the database view (MEM navigation) by pressing the **MEM** key.
- Select the DUT or its ID number for the following measurements with the scroll keys. 
- Return to the measuring view by pressing the **MEM** key or the **START/STOP** key.
- Start the test with the **START/STOP** key. The symbol shown at the right appears and the zero indicates that no measurements have yet been recorded or saved to buffer memory. 
- Each time the key at the right is pressed, the respective current measured value is saved to buffer memory and the number shown in the symbol is increased. In this way, you always know how many measurements have already been recorded. 
- Stop the measurement by pressing the **START/STOP** key, unless a specified measuring time has been stipulated. The **save as** symbol appears (floppy disk icon with the number of measured values saved to the clipboard). 
- If you press the save symbol now (floppy disk), the display is switched to the DUT in the database view for checking.
- After pressing the save symbol once again, acknowledgement of successful storage appears. At the same time, the display is switched to the measuring view.

Measuring Sequence with Subsequent Entry of the DUT

- Start the measurement by pressing the **START/STOP** key. The symbol shown at the right appears and indicates how many measurements have already been performed. 
- Stop the measurement by pressing the **START/STOP** key, unless a specified measuring time has been stipulated. The save symbol (floppy disk with a number 1) appears and indicates that one valid measured value has been recorded, which can now be saved. 
- Press the **save symbol** (floppy disk). 
- You are informed that you haven't selected a DUT in the database. 
- There are two ways to subsequently select a DUT using an ID number which has already been set up in the database:
 - Select the ID number with a **barcode scanner** or
 - Enter an ID number by pressing the **ID** key. 
- The cursor jumps to the location of the DUT with the selected ID number. You only need to acknowledge this position by pressing the green checkmark.
- Press the save symbol (floppy disk). A message appears indicating that the data have been successfully saved and the display is switched to the measuring view.

Note

If the entered number cannot be found in the database (because it hasn't been set up), it can be entered immediately by pressing **Yes** when the prompt appears. However, the storage location cannot be selected in this case. The measurement is saved to the most recently selected hierarchy.

**Note**

Measurements and measurement series can only be saved after measurement has been completed. Measured values can only be added to intermediate buffer memory during a measurement. Customer, location and other entries cannot be changed in the memory menu. These have to be selected directly in the database and entered or changed.

**Note**

Please observe the following before storing tests or measurements to the test instrument:

The date of recalibration may be printed on test reports or transmitted to a PC during the export of test data. We therefore recommend that you check the recalibration date saved in the test instrument before starting to work with your new test instrument (see page 11).

8.5 Measuring Protective Conductor Resistance – RPE

Single measurements, rotary switch level: green			
Switch Position	Measurement Type, With Mains to Test Socket	Measurement Type, Without Mains to Test Socket	Measuring Functions
R _{PE}		Passive: PE(TS) - P1	R _{PE} Protective conductor resistance Test current: 200 mA Test current: 10 A ¹
	Active: PE(TS) - P1 ⁴		
		PE(mains) - P1	
		PE(mains) - P1 clamp ³	
		P1 - P2 ²	

¹ SECUTEST BASE10/PRO (feature G01): 10 A-RPE measurements are only possible with line voltages of 115/230 V and line frequencies of 50/60 Hz.

² Connection for 2nd test probe for 2-pole measurement with SECUTEST PRO only (or instrument with feature H01)

³ Can only be selected if the IP(set) parameter has been set to 10 A~, with SECUTEST PRO only (or instrument with feature G01)

⁴ Can only be selected with SECUTEST BASE or if the IP(set) parameter has been set to 200 mA.

Application, Definition, Measuring Method

Protective conductor resistance is the sum of the following resistances:

- Connector cable or device connector cable resistance
- Contact resistance at plug and terminal connections
- Resistance of the extension cord if applicable

Protection Class I Devices

– Measurement type PE(TS) - P1 (passive)

– DUT mains plug to test socket

– Test probe P1 to P1 terminals

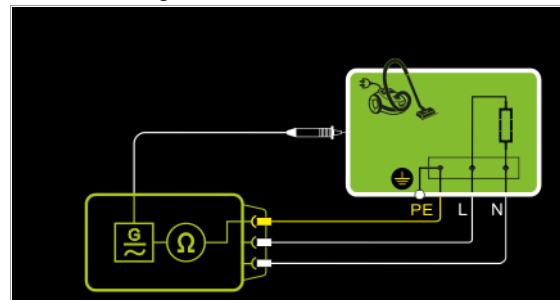
Schematic Diagram

Protective conductor resistance is measured between the earthing contacts at the mains plug and the earthing contact connected to the housing by contacting the housing with test probe P1.

Wiring Diagram

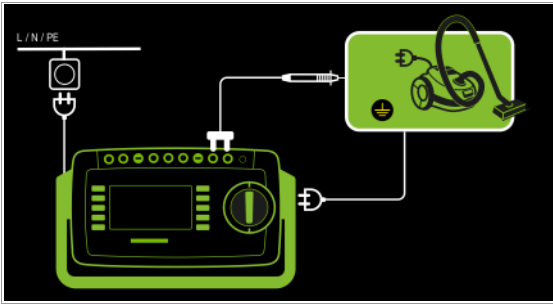

Measurement of RPE at Single-Phase Extension Cords with EL1

- Measurement type *PE(TS) - P1 (passive)*
- Extension cord plug connected to test socket
- EL1 to P1 terminals

Schematic Diagram

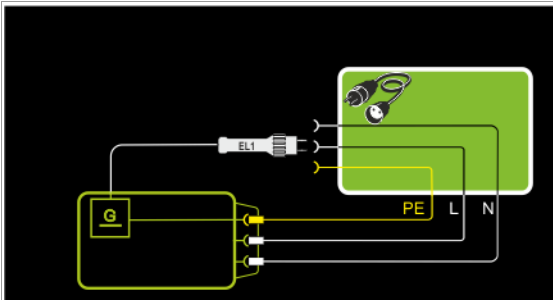

Wiring Diagram

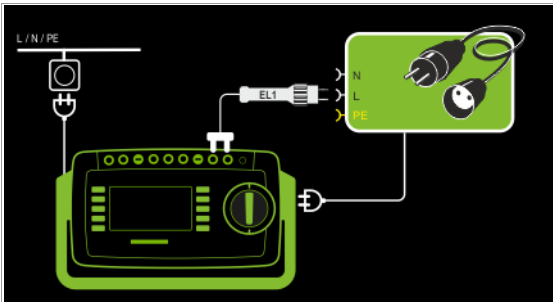

Protection Class I Devices

Special Case: Line Voltage at Test Socket (for testing PRCDs)

- Measurement type *PE(TS) - P1 (active)*
- DUT mains plug to test socket
- Test probe P1 to P1 terminals

Schematic Diagram

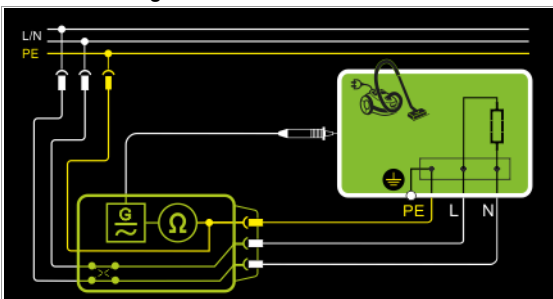

Protective conductor resistance is measured between the earthing contacts at the mains plug and the earthing contact connected to the housing by contacting the housing with test probe P1.

Wiring Diagram

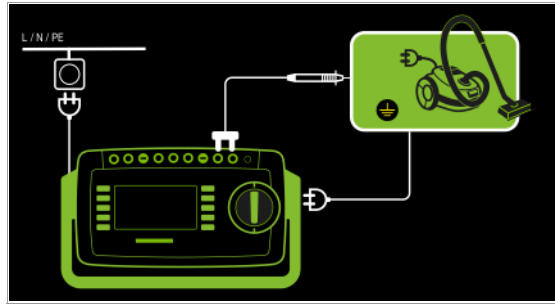

Protection Class I Devices

Special case: permanently installed DUTs

- Measurement type *PE(mains) - P1*
- Test probe P1 to P1 terminals

Schematic Diagram

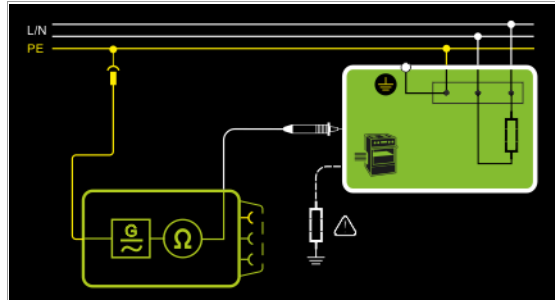

In the case of *permanently installed DUTs*, protective conductor resistance is measured between the mains power earthing contact and the earthing contact connected to the housing by contacting the housing with test probe P1.

Wiring Diagram

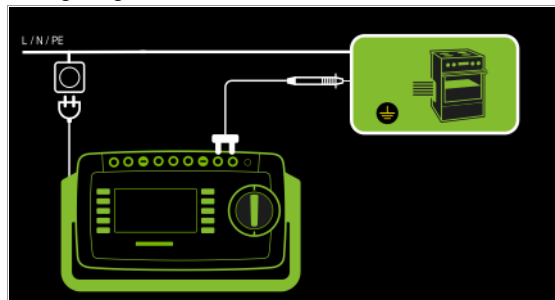

Measurement via current clamp sensor at permanently installed DUT

– Measurement type *PE(mains) - P1 clamp*

- Test probe P1 to P1 terminals
- Clamp to COM-V (only with SECUTEST PRO or featureI01 with optional WZ12C current clamp sensor)

Schematic Diagram

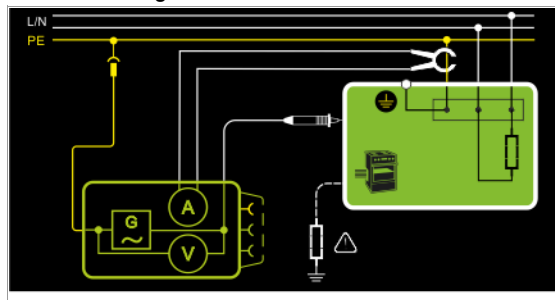

Measurement of test current by closing the current clamp sensor around mains PE and contacting the housing with test probe P1 for permanently installed protection class I devices under test

Wiring Diagram

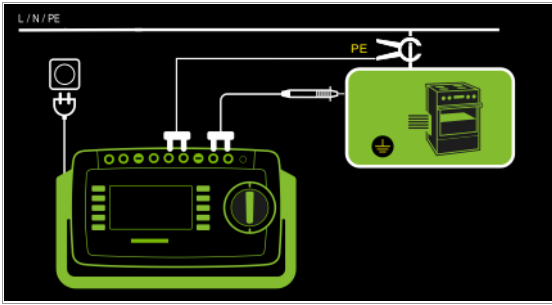

Set Measuring Range at Current Clamp Sensor and Parameter at the SECUTEST PRO

This measurement type can only be selected if test current is set to 10 A AC.

SECUTEST PRO	Current Clamp Sensor	SECUTEST PRO
Transformer Ratio Parameter	Transformer Ratio (Switch*)	Measuring Range
1:1	WZ12C	0 mA ... 300 A
1 V / A	1 mV / mA	1 mA... 15 A
100:1	SECUTEST CLIP	0 mA ... 300 A
1 V / 10 mA	100 mV/mA	0.1...25 mA

* only with WZ12C

2-Pole Measurement at Permanently Installed DUTs (only with SECUTEST PRO or feature H01)

- Measurement type P1 - P2
- Test probe P1 to P1 terminals
- Test probe P2 to P2 terminals

Schematic Diagram

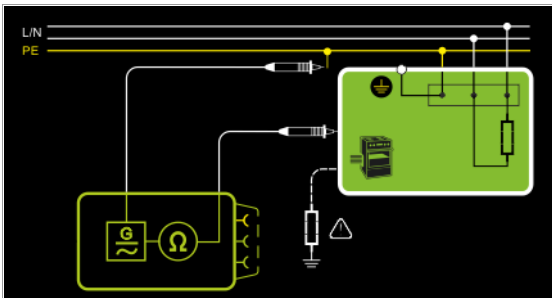

PE at the mains connection is contacted with the second test probe instead of via the test instrument's mains plug.

Wiring Diagram

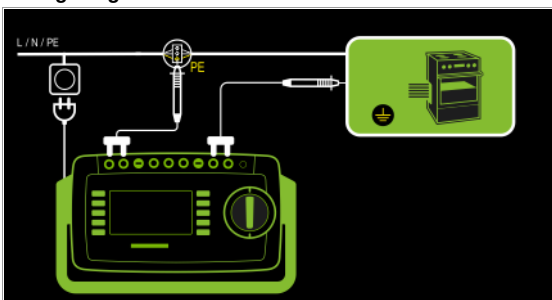

Resistance is measured:

- Between each exposed *conductive part of the housing* and the earthing contacts at the mains and the device plug (if a removable mains connector cable is used), or the protective conductor terminal for permanently installed devices.
- As 4-pole measurement
- Between the earthing contacts at the mains plug and the earthing contacts at the device plug for *device connector cables*
- Between the earthing contacts at the mains plug and the earthing contacts at the coupling socket for *extension cords*

Setting Measuring Parameters for RPE



Measuring Parameter	Meaning	
Measurement Type,		Suitable for DUT Connection via
(passive:) PE(TS) – P1	Testing is conducted between the two protective conductor terminals: at the test socket and test probe P1.	Test socket, EL1 with DUT at test socket, VL2E, AT3 adapter (AT3-III E, AT3-IIS, AT3-IIS32), AT16DI/AT32DI
Active: PE(TS) – P1 ¹	Same as PE(TS) – P1, but with line voltage to the test socket, 200 mA AC flow immediately. A ramp-like, slowly rising DC test current flows (PRCD triggering is avoided) at +200 mA DC, –200 mA DC and ±200 mA DC.	Test socket (for PRCDs)
PE(mains) – P1 <i>permanently connected DUTs</i>	Testing is conducted between the ground terminal at the mains and test probe P1.	Permanent connection
P1 – P2	SECUTEST PRO or feature H01: 2-pole measurement between test probes 1 and 2 (see section 6.6)	Permanent connection
Clamp ²	SECUTEST PRO or feature G01 and I01: Test current measurement with current clamp sensor	Permanent connection
IP(set)		
+200 mA DC	Test current: positive direct current	
-200 mA DC	Test current: negative direct current	
±200 mA (DC)	Test current: direct current whose polarity is reversed every 2 secs.	
200 mA (AC)	Test current: alternating current	
10 A (AC)	10 A test current: SECUTEST BASE10 or PRO only (feature G01)	
f – only at 200 mA (AC)		
50 ... 200 Hz	Test frequency	
Offset		
> 0 to < 2 Ω	Zero balancing for a selected reference point.	
Clamp factor – only with measuring type „Clamp“		
1:1	Transformer ratio of the current clamp sensor WZ12C . For setting the current clamp factor at the WZ12C clamp and the SECUTEST PRO (see table above).	
100:1	Transformer ratio of the current clamp sensor SECUTEST CLIP . For setting the current clamp factor at the SECUTEST PRO .	

¹ SECUTEST BASE10/PRO (feature G01): Measurement cannot be performed with 10 A AC for this measurement type.

² SECUTEST BASE10/PRO (feature G01):
This measurement type can only be selected with a selected test current of 10 A AC.

Entering and Deleting Offset Values

The test instrument determines protective conductor resistance by means of a 4-pole measurement. If measurement cables or extension cords are used whose ohmic resistance should be automatically subtracted from the measurement results, there are two ways to save the respective offset value in the R_{PE} switch position:

- Entry via the numeric keypad
- Acceptance of the momentary measured value by pressing the **SET OFFSET** softkey

Proceed as follows in order to accept the measured value:

- ⇨ Start the measurement and wait until the measured value settles in.
 - ⇨ Press the **SET OFFSET** key. The value is transferred to the offset field.
- The entered or accepted offset value is permanently stored and is subtracted from all protective conductor resistance values measured in the future. This applies to single measurements as well as to measurements conducted in the AUTO switch positions. The $\overline{R_{PE}}$ symbol is displayed in the header in all switch positions until the offset value is deleted by pressing the **CLEAR OFFSET** softkey (R_{PE} switch position).

Test Sequence with Connection to the Test Socket

- ⇨ Set the rotary switch to the **R_{PE}** position.
- ⇨ Select measurement type or connection type, and test current. After pressing the **lp** key, you have direct access to the test current parameters: each time this key is pressed, the setpoint value shown in the measuring window is switched to the next value.
- ⇨ Connect the DUT to the test socket.
- ⇨ **Start the test:** press the **START/STOP** key.



- ⇨ Contact all conductive parts which are connected to the protective conductor with test probe P1.

During measurement, the **connector cable** must only be moved to the extent to which it's accessible during repair, modification or testing.

If a change in resistance occurs during the manual test step of the continuity test, it must be assumed that the protective conductor is damaged, or that one of the connector contacts is no longer in flawless condition.

- ⇨ The measured values are displayed. The measured value recording symbol shown at the right appears. Each time this key is pressed, the currently displayed measured value is saved to the buffer.



- ⇨ **Stop the test:** press the **START/STOP** key. The save symbol appears (floppy disk showing the number of measured values stored to buffer memory) and prompts you to save the measured values to an ID number.



- ⇨ Read the measured values and compare them with the table of permissible limit values.
- ⇨ Press the **ESC** key in order to discard the measured values stored to buffer memory and acknowledge by pressing the key shown at the right.



Special Case: Testing Protective Conductor Resistance at PRCDs (as of firmware V1.4.0)

For PRCDs whose protective conductor resistance cannot be measured when switched off, the **SECUTEST BASE(10)** offers the "active: PE(TS) - P1" measurement type, with which the PRCD can be switched on in order to ascertain protective conductor resistance.

- ⇨ Set the measurement type parameter to "active: PE(TS) - P1".
- ⇨ Connect the EL1 adapter (or alternatively a normal test probe) to the P1 sockets at the test instrument.
- ⇨ Connect the plug of the PRCD under test to the test socket.
- ⇨ Connect the EL1 adapter to the outlet on the PRCD (alternative: connect the test probe to the protective conductor of the PRCD's outlet, e.g. by means of an alligator clip).
- ⇨ Start the measurement.
- ⇨ Switch line voltage to the test socket. Then switch the PRCD on.
- ⇨ Otherwise, the test sequence is the same as described above.



Note

With the +200 mA=, -200 mA= and ±200 mA= measurement types, test current rises very slowly in order to prevent triggering of residual current monitoring at the PRCD. And thus with this measurement type, it may take longer than usual until a valid measured value is displayed. For this reason, the protective conductor should not be contacted manually with the test probe, in order to prevent a sudden rise in test current resulting in inadvertent tripping of the PRCD.

Special Case: Testing Extension Cords

- ⇨ Set the measurement type parameter to "PE(TS) - P1".
- ⇨ Connect the EL1 adapter to the P1 sockets at the test instrument.
- ⇨ Connect the plug at the end of the extension cord to the test socket.
- ⇨ Connect the coupling socket at the end of the extension cord to the plug at the EL1 adapter.
- ⇨ Same test sequence as described above.

Further options for testing extension cords are included in the description of single measurements in the EL1 switch position and under automatic test sequences in switch position A8.

Special case: permanently installed DUT

- ⇨ Contact all conductive housing parts with test probe P1.

Maximum Allowable Limit Values for Protective Conductor Resistance for Connector Cables with Cross-Sections of up to 1.5 sq. mm and Lengths of up to 5 m

Test Standard	Test Current	Open-Circuit Voltage	R _{SL} Housing – Device Plug	R _{SL} Housing – Mains Plug	Mains Power Cable
VDE 0701-0702:2008 DIN EN 60974-4 VDE 0544-4:2009-06	> 200 mA=	4 V < U _L < 24 V		0.3 Ω + 0.1 Ω ¹ for each additional 7.5 m	
IEC 62353 (VDE 0751-1)	> 200 mA=		0.2 Ω	0.3 Ω	0.1 Ω

¹ Total protective conductor resistance: max. 1 Ω

8.6 Insulation Resistance Measurement – RISO

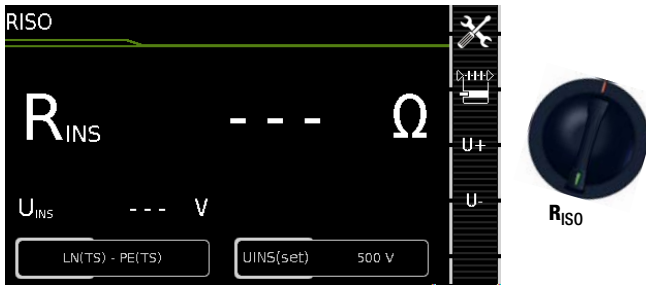

Single measurements, rotary switch level: green

Switch Position	Measuring Functions	Measurement Type, Without Mains to Test Socket
R _{ISO}	R _{ISO} Insulation resistance (PC I/PC II)	LN(TS) - PE(TS)
	U _{ISO} Test voltage	LN(TS) - P1 P1 - P2 ¹ PE(mains) - P1 PE(TS) - P1 LN(TS) - P1//PE(TS)

¹ Connection for 2nd test probe for 2-pole measurement with SECUTEST PRO only (or instrument with feature H01)

Application, Definition, Measuring Method

Protection Class I Devices

- Measurement type LN(TS) - PE(TS)
- DUT mains plug to test socket

Schematic Diagram

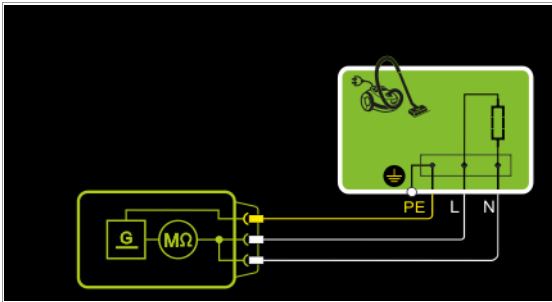

Insulation resistance is measured between short-circuited mains terminals (L-N) and protective conductor PE.

Wiring Diagram

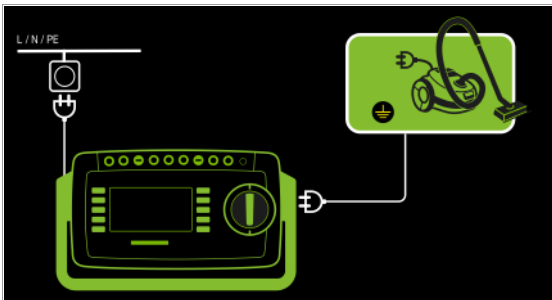

Protection Class II Devices

- with Exposed Conductive Parts
- Measurement type LN(TS) - P1
- DUT mains plug to test socket
- Test probe P1 to P1 terminals

Schematic Diagram

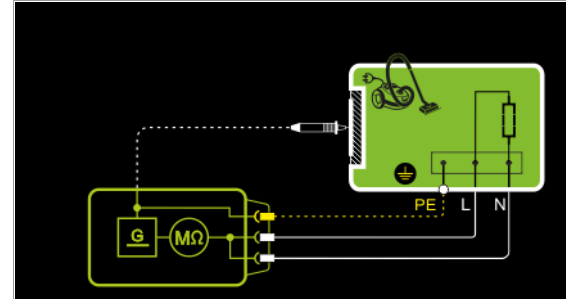

Insulation resistance is measured between short-circuited mains terminals (L-N) and external conductive parts which can be contacted with test probe P1 and are **not** connected to the housing.

Wiring Diagram

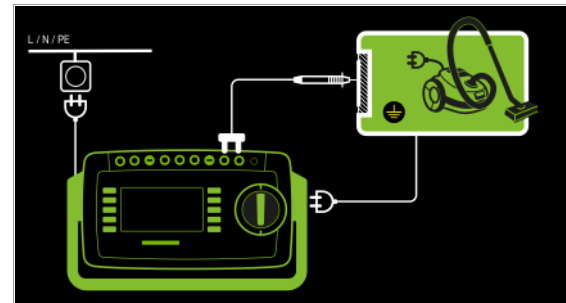

Protection Class II Devices with Outputs for Safety Extra-Low Voltage

- Measurement type LN(TS) - P1
- DUT mains plug to test socket
- Test probe P1 to P1 terminals

Schematic Diagram

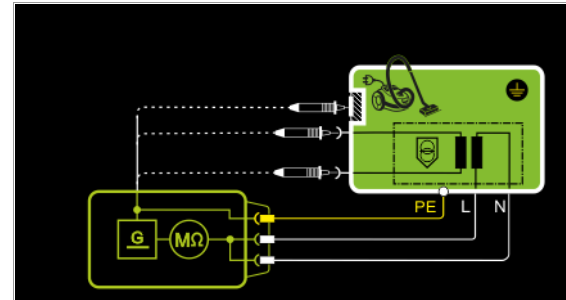

Insulation resistance is measured between short-circuited mains terminals (L-N) and the short-circuited safety extra-low voltage outputs which are contacted with probe P1.

Wiring Diagram

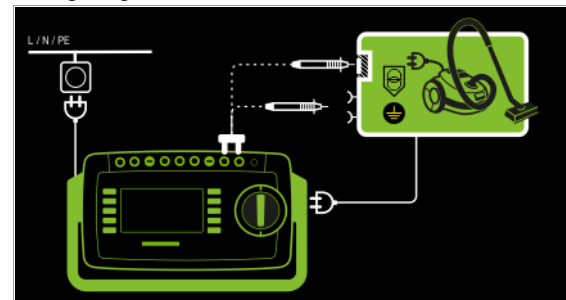

Protection Class I Devices with Outputs for Safety Extra-Low Voltage and Exposed Conductive Parts

- Measurement type LN(TS) - P1
- DUT mains plug to test socket
- Test probe P1 to P1 terminals

Schematic Diagram

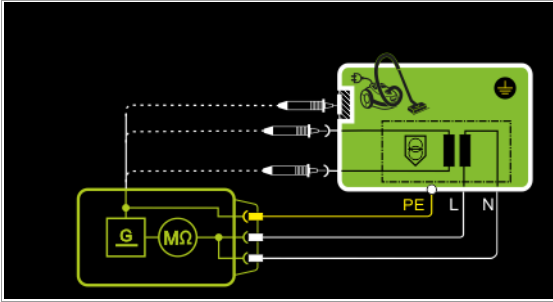

Insulation resistance is measured successively between short-circuited mains terminals (L-N) and the safety extra-low voltage outputs which can be contacted with test probe P1, as well as external conductive parts which are **not** connected to the housing.

If measuring points should be contacted one after the other, this is indicated by a dashed line. However, there are two parallel measuring circuits for the RISO measurement with the LN(PD) – P1//PE(PD) measuring parameter, which are established simultaneously to the short-circuited L and N conductors: one insulation resistance is measured via PE at the test socket and, at the same time, a second insulation resistance is measured via test probe P1.

Wiring Diagram

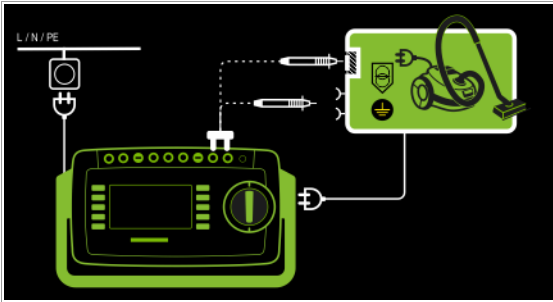

2-Pole Measurement at Protection Class I Housing Parts (only with SECUTEST PRO or feature H01)

- Measurement type P1 - P2

Schematic Diagram

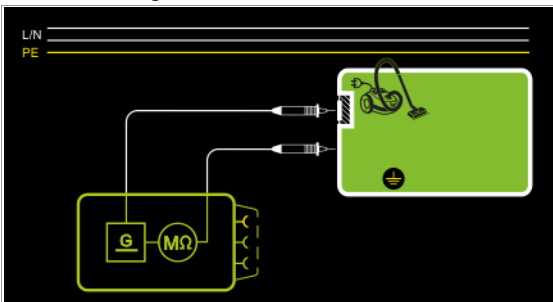

Insulation resistance is measured between external conductive parts which can be contacted with test probe P2 and are **not** connected to the housing, and the housing with test probe P1.

Wiring Diagram

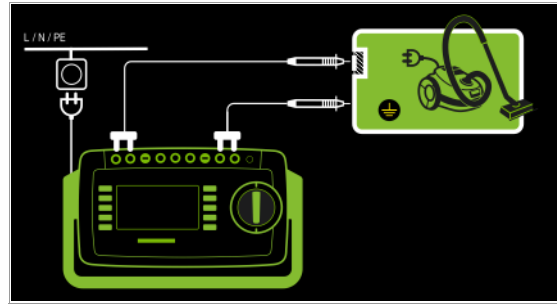

Special Case: Permanently Installed Protection Class I Devices

- Measurement type PE(mains) - P1
- Test probe P1 to P1 terminals

Schematic Diagram

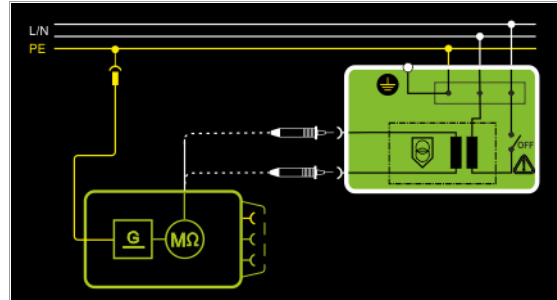

Insulation resistance is measured successively between PE at the mains connection and the extra-low voltage inputs by contacting each of them with test probe P1.

Wiring Diagram

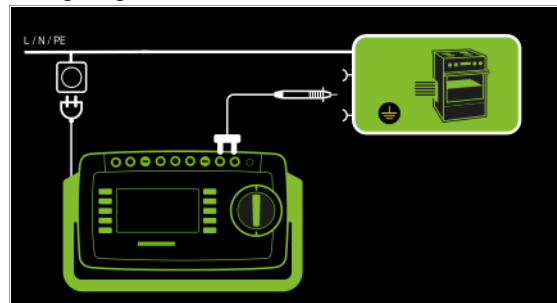

Attention!

Deactivate the electrical system which supplies power to the device under test before connecting the test instrument!

- Remove the mains fuses from the device under test and disconnect neutral conductor N inside the device under test.
- Connect test probe P1 to phase conductor L at the device under test in order to measure insulation resistance.

- Protection Class I Devices with Terminals for Applied Parts**
 – Measurement type PE(TS) - P1
 – DUT mains plug to test socket
 – Test probe P1 to P1 terminals

Schematic Diagram

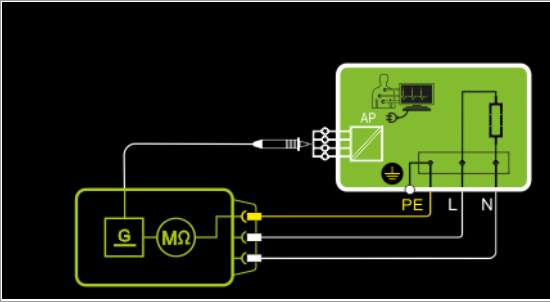

Insulation resistance is measured between protective conductor terminal PE and external, short-circuited applied parts which can be contacted with test probe P1.

Wiring Diagram

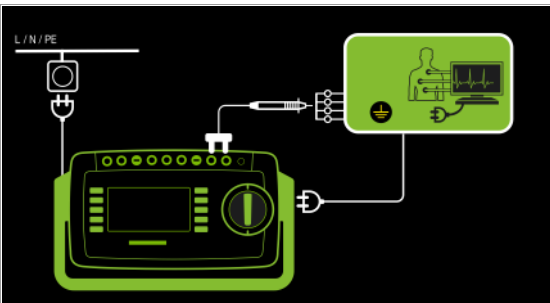

- Protection Class I Devices with Exposed Conductive Parts**
 – Measurement type LN(TS) - P1//PE(TS)
 – DUT mains plug to test socket
 – Test probe P1 to P1 terminals

Schematic Diagram

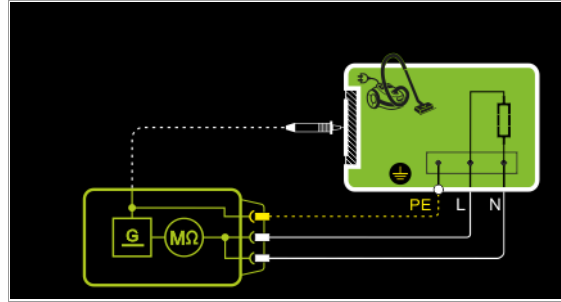

Insulation resistance is measured between short-circuited mains terminals (L-N) and external conductive parts which can be contacted with test probe P1 and are **not** connected to the housing, as well as protective conductor terminal PE at the housing.

Wiring Diagram

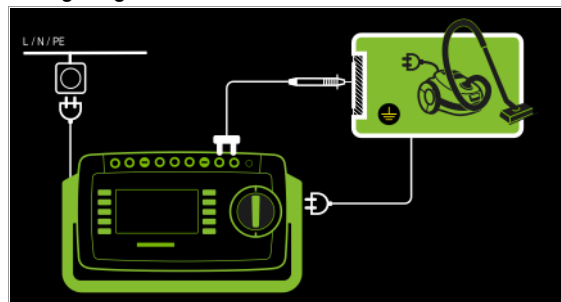

- Protection Class I Devices with Outputs for Safety Extra-Low Voltage**
 – Measurement type PE(TS) - P1
 – DUT mains plug to test socket
 – Test probe P1 to P1 terminals

Schematic Diagram

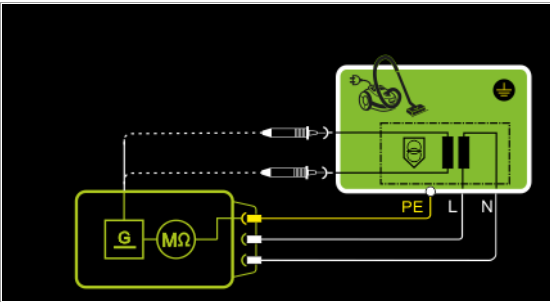

Insulation resistance is measured between the PE terminal and the safety extra-low voltage outputs, which must be contacted one after the other with probe P1.

Wiring Diagram

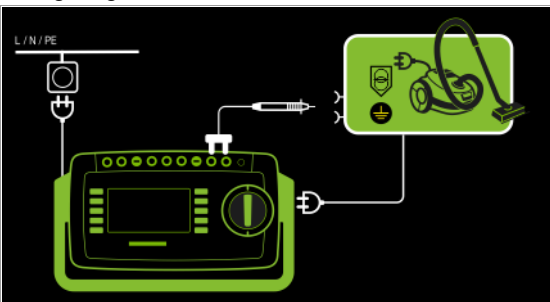

Setting Measuring Parameters for RISO



Measuring Parameter	Meaning	
Measurement Type,		Suitable for DUT Connection via
LN(TS)-PE(TS)	PC I: Testing is conducted between short-circuited LN mains terminals at the test socket and the DUT's PE terminal	Test socket, VL2E, AT3 adapter (AT3-IIIE, AT3-IIS, AT3-IIS32), AT16DI/AT32DI, CEE adapter
LN(TS)-P1	Testing is conducted between short-circuited LN mains terminals at the test socket and test probe P1.	Test socket, VL2E, AT3 adapter (AT3-IIIE, AT3-IIS, AT3-IIS32), AT16DI/AT32DI
P1 – P2	SECUTEST PRO or feature H01: 2-pole measurement between test probes 1 and 2 (see section 6.6)	No connection (PC3)
PE(mains)-P1	Cable test: Testing is conducted between the ground terminal at the mains and test probe P1.	Permanent connection
PE(TS)-P1	Testing is conducted between the PE terminal at the test socket and test probe P1.	Test socket
LN(TS)-P1 // PE(TS)	Testing is conducted between short-circuited LN mains terminals at the test socket and test probe P1, including PE at the test socket.	Test socket, VL2E, AT3 adapter (AT3-IIIE, AT3-IIS, AT3-IIS32), AT16DI/AT32DI
UIISO(set)		
> 50 ... < 500 V	Variable test voltage can be entered with the numeric keypad	

Test Sequence



Attention!

Prerequisite for Testing

The measurement of insulation resistance may not be conducted on protection class I devices which have not passed the protective conductor resistance test.



Note

The insulation test cannot be performed for all DUTs, for example electronic devices, EDP equipment, medical devices etc. Leakage current measurements must be performed for these DUTs (see Section 8.7). Observe the notes in the service instructions.



Attention!

In order to prevent damage to the instrument, measurement of insulation resistance may only be performed between application parts, measurement inputs or interfaces and the protective conductor or the housing if the instrument is laid out for measurements of this type.



Attention!

Touching the DUT During Measurement

Testing is conducted with up to 500 V, and although current is limited ($I < 3.5 \text{ mA}$), if the DUT is touched electrical shock may occur which could result in consequential accidents.



Attention!

Switch Settings at the DUT

All switches at the DUT must be set to the on position during measurement of insulation resistance, including temperature controlled switches and temperature regulators as well.

Measurement must be performed in all program steps for devices equipped with program controllers.

- ⇨ Set the rotary switch to the R_{ISO} position.
- ⇨ Select the measurement type and the test voltage.
- ⇨ The **Up-** and **Up+** keys provide you with direct access to the test voltage parameters: each time this key is pressed, the setpoint value shown in the measuring window, $U_p(\text{set})$, is reduced or increased by 10 V.
- ⇨ Connect the DUT to the test socket.
- ⇨ **Start the test:** press the **START/STOP** key.



Note

The measurement is disabled if a voltage of greater than 25 V is measured between the terminals.

- ⇨ The measured values are displayed. The measured value recording symbol shown at the right appears. Each time this key is pressed, the currently displayed measured value is saved to the buffer.



Attention!

Removing the Connector Cable

Do not remove the DUT's connector cable until the test has been stopped, in order to assure that the capacitors have been discharged.

- ⇨ **Stop the test:** press the **START/STOP** key. The save symbol appears (floppy disk showing the number of measured values stored to buffer memory) and prompts you to save the measured values to an ID number.
- ⇨ Read the measured values and compare them with the table of permissible limit values.
- ⇨ Press the **ESC** key in order to discard the measured values stored to buffer memory and acknowledge by pressing the key shown at the right.



Minimum Allowable Limit Values for Insulation Resistance

Test Standard	Test Voltage	R_{ISO}				
		LN → PE	LN → Probe	Probe → PE	PC III	Heating
VDE 0701-0702:2008	500 V	1 M Ω	2 M Ω	5 M Ω	0.25 M Ω	0.3 M Ω *
DIN EN 60974-4 VDE 0544-4:2009-06		2 M Ω	5 M Ω	5 M Ω		

* With switched on heating elements (if heating power $> 3.5 \text{ kW}$ and $R_{ISO} < 0.3 \text{ M}\Omega$: leakage current measurement is required)

Test Standard	Test Voltage	R_{ISO}	
		PC I	PC II
IEC 62353 (VDE 0751-1)	500 V	2 M Ω	7 M Ω
		BF or CF	BF or CF
		70 M Ω	70 M Ω

Notes

Insulation resistance and/or leakage current must be measured by contacting all exposed, conductive parts with test probe P1 for protection class II and III devices, as well as for battery powered devices.

Batteries must be disconnected during testing of battery powered devices.

8.7 Measuring Leakage Current



Attention!

Measurement with DUT Connected to Line Voltage

It's absolutely essential to assure that the device under test is operated with line voltage during performance of **leakage current measurements with the direct or differential current method**. Exposed conductive parts may conduct dangerous touch voltage during testing, and may not under any circumstances be touched. (Mains power is disconnected if leakage current exceeds approx. 10 mA.)

Frequency response in accordance with the figure to the right is taken into consideration for all leakage current measurements (**IPE, IB, IG, IP**) (direct, differential, alternative).

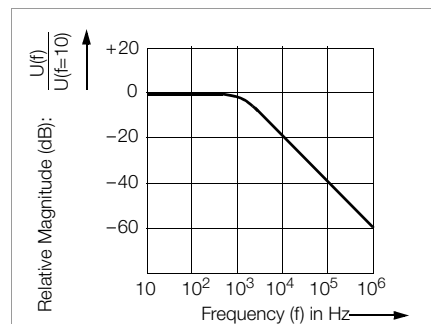

8.7.1 Protective Conductor Current – IPE

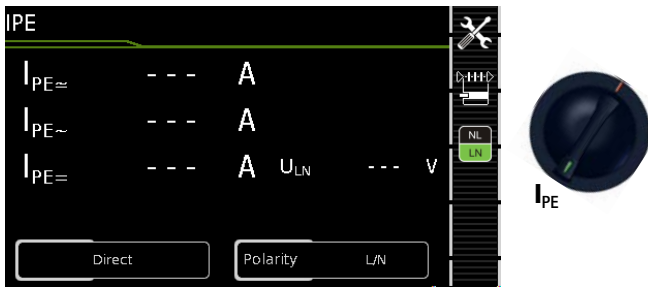

Single measurements, rotary switch level: green			
Switch Position	Measurement Type, With Mains to Test Socket	Measurement Type, Without Mains to Test Socket	Measuring Functions
I _{PE}	Direct		I _{PE≈} Protective conductor current, RMS I _{PE~} AC component I _{PE=} DC component U _{LN} Test voltage
		Differential	I _{PE≈} Protective conductor current, RMS U _{LN} Test voltage
	AT3 adapter ¹	Alternative	I _{PE≈} Protective conductor current, RMS U _~ Test voltage
		Clamp ²	I _{PE≈} Protective conductor current, RMS U _{LN} Test voltage

¹ Adapter AT3-III, AT3-IIS or AT3-II S32:

Voltage measuring inputs for leakage current measurement with differential method with **SECUTEST PRO** only (or instrument with feature IO1)

² Voltage measuring inputs for leakage current measurement with differential method using the WZ12C or **SECUTEST CLIP** current clamp sensor, with **SECUTEST PRO** only (or instrument with feature IO1)

Applications

Protective conductor current must be measured for protection class I devices.

Definition of Protective Conductor Current (direct measurement)

Current which flows through the protective conductor in the case of housings which are isolated from ground.

Definition of Differential Current

Sum of instantaneous current values which flow via the L and N conductors at the device mains connection. Differential current is practically identical to fault current in the event of an error. Fault current: Current which is caused by an insulation defect, and which flows via the defective point.

Definition of Alternative Measuring Method (equivalent leakage current)

Equivalent leakage current is current which flows through the active conductors of the device which are connected to each other (L/N) to the protective conductor (SC1), or to the exposed, conductive parts (SC2).

Differential Current Measuring Method

The device under test is operated with mains power. The sum of the momentary values of all currents which flow through all active conductors (L/N) at the mains side of the device connection is measured. The measurements must be performed with mains plug polarity in both directions.

Alternative Measuring Method (equivalent leakage current)

A high-impedance power supply is connected between the short-circuited mains terminals and all exposed metal parts of the housing (which are connected to one another).

Current which flows over the insulation at the device under test is measured.

Protective Conductor Current Measuring Method (direct measurement)

The device under test is operated with mains power. Current which flows through the PE conductor to earth at the mains side of the device connection is measured.



Note

Regardless of the currently selected connection type, all help images and schematic diagrams can be queried for the selected measuring function.

Direct Measuring Method – Direct measurement type – DUT mains plug to test socket

Schematic Diagram

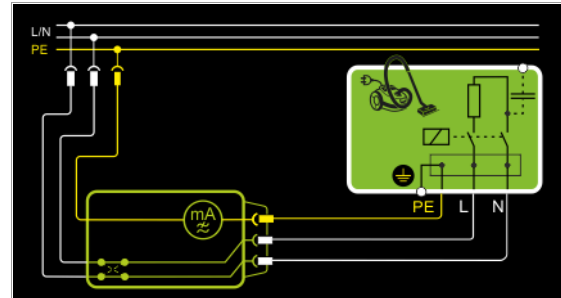

The device under test is operated with mains power.

Protective conductor current is measured between the protective conductor at the mains and the protective conductor terminal at the DUT via the DUT's mains cable.

Wiring Diagram

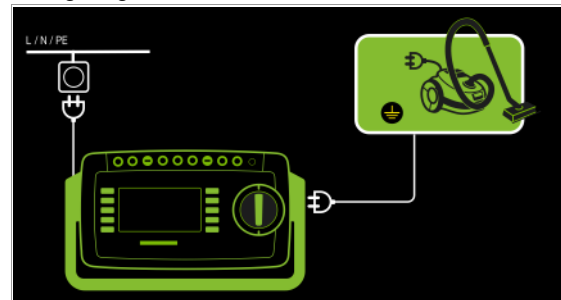

Differential current measurement – Differential measurement type – DUT mains plug to test socket

Schematic Diagram

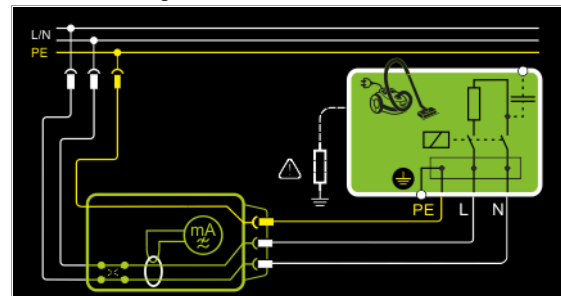

The device under test is operated with mains power.

Differential current is measured between mains conductors L and N (current clip concept).

Wiring Diagram

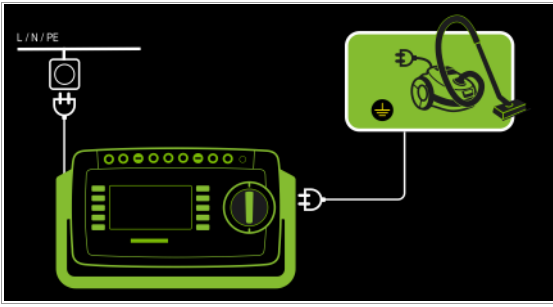

Wiring Diagram (AT3-III E probe to COM-V)

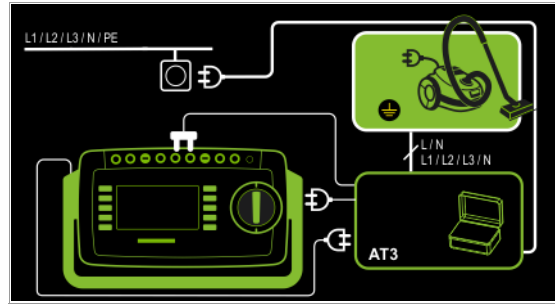

Alternative Measuring Method (equivalent leakage current)

– *Alternative measurement type*

– DUT mains plug (protection classes I) to test socket

Schematic Diagram

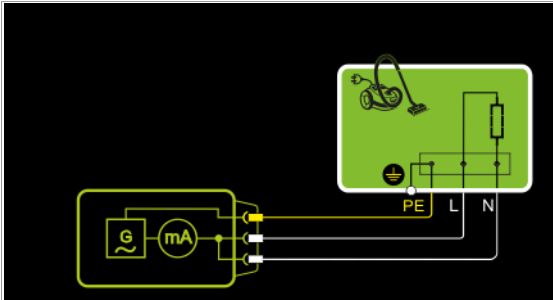

After activating test voltage, leakage current is measured via the DUT's mains cable between short-circuited mains conductors L and N and the protective conductor terminal at the DUT.

Wiring Diagram

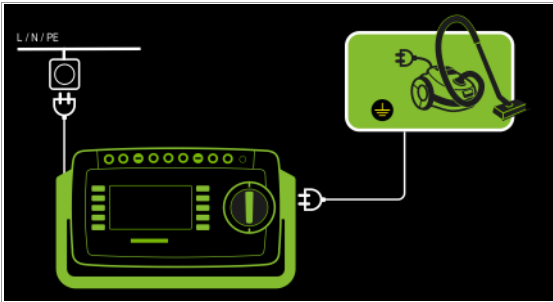

Connection of 3-phase DUTs (only with SECUTEST PRO or feature I01 with optional test adapter AT3-III E)

– *AT3-Adapter measurement type*

– DUT mains plug to AT3-III E test adapter

– AT3-III E probe to COM-V terminals

– AT3-III E test plug to test socket

Schematic Diagram

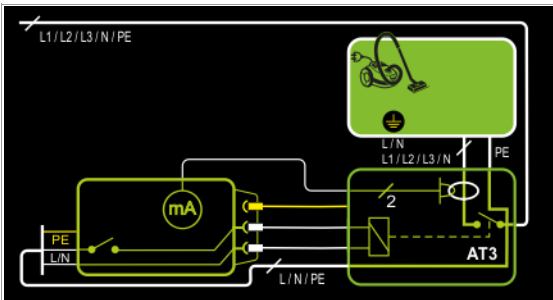

Measurement of the DUT with 3-phase mains connection via AT3-III E adapter

Measurement of protective conductor current via current clamp sensor with voltage output for permanently installed DUTs (only with SECUTEST PRO or feature I01 with optional WZ12C current clamp sensor)

– *Clamp measurement type*

Schematic Diagram

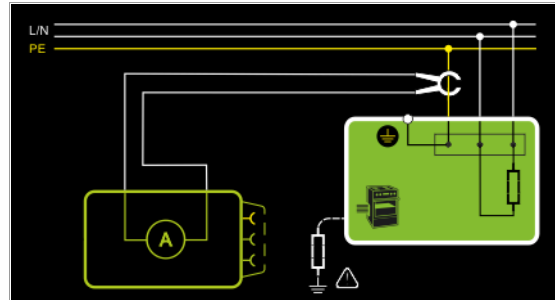

Measurement of protective conductor current by closing the current clamp sensor around mains PE in the power cable for permanently installed protection class I devices under test

Wiring Diagram (Current Clamp Sensor to COM-V)

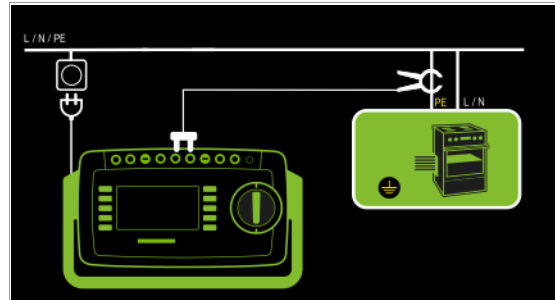

Set Measuring Range at Current Clamp Sensor and Parameter at the SECUTEST PRO

SECUTEST PRO Transformer Ratio Parameter	Current Clamp Sensor		SECUTEST PRO Display Range with Clamp
	Transformer Ratio (Switch*)	Measuring Range	
1 : 1	WZ12C		0 mA ... 300 A
	1 mV : 1 mA	1 mA... 15 A	
100 : 1	SECUTEST CLIP		0.00 mA ... 3.00 A
	100 mV : 1 mA	0.1...25 mA	









* only with WZ12C

Setting Measuring Parameters for IPE



Measuring Parameter	Meaning	
Measurement Type,		Suitable for DUT Connection via
Direct	Direct measuring method	Test socket, AT16DI/AT32DI (direct or diff.)
Differential	Differential current measurement	Test socket
Alternative	Equivalent leakage current method	Test socket, VL2E, AT3 adapter (AT3-III E, AT3-IIS, AT3-IIS32), AT16DI/AT32DI
AT3 adapter	SECUTEST PRO or feature I01: measurement with AT3 adapter	AT3-III E, AT3-IIS, AT3-IIS32
Clamp	SECUTEST PRO or feature I01: Measurement of protective conductor current via current clamp sensor with voltage output, and conversion to and display as current values.	Permanent connection
Polarity – for direct and differential measurement types only		
L/N or N/L	Selection of polarity for mains voltage to the test socket	
The measuring parameters of measuring type „Alternative“ U(setpoint) and frequency(setpoint) are no longer included as from firmware version 1.7.0. These parameters apply to individual measurements as well as test sequences and have to be entered in the SETUP, see section 6.2		
U(set) – for alternative measurement type only		
110 V, 115 V, 220 V, 230 V, 240 V	Selection of a line voltage for synthetic test voltage	
Frequency – for alternative measurement type only		
48 Hz ... 400 Hz	Selection of a line frequency for synthetic test voltage	
Clamp factor – only for clamp measurement type		
1:1	Transformer ratio of the current clamp sensor WZ12C . For setting the current clamp factor at the WZ12C clamp and the SECUTEST PRO (see table above).	
100:1	Transformer ratio of the current clamp sensor SECUTEST CLIP . For setting the current clamp factor at the SECUTEST PRO .	

Test Sequence for Direct Measuring Method

- ⇨ Prior to all leakage current measurements, please make sure that the measurement parameters „Ref. voltage L-PE“ and „Testingfreq. Alt“ have been correctly set in the SETUP, see section 6.2.
- ⇨ Set the rotary switch to the **I_{PE}** position.
- ⇨ Select the **Direct** measurement type:
 - By setting the parameters 
 - or
 - Directly by pressing the key shown at the right
- ⇨ Connect the DUT's mains plug (protection class I) to the test instrument's test socket.
- ⇨ Make sure that the device under test is switched off.
- ⇨ **Start the test:** press the **START/STOP** key. 
- ⇨ Switch the device under test on.
- ⇨ The measurement must be performed with mains plug polarity in both directions. by pressing the **NL/LN** key. 
- ⇨ Acknowledge the warning which indicates that line voltage will be connected to the test socket. 
- ⇨ Switch the device under test on.
- ⇨ Contact all accessible conductive parts, one after the other, with test probe P1, which are not connected to the housing, as well as any output sockets for safety extra-low voltage if included.
- ⇨ The measured values are displayed. The measured value recording symbol shown at the right appears. Each time this key is pressed, the currently displayed measured value is saved to the buffer. 
- ⇨ Turn off the device under test.
- ⇨ **Stop the test:** press the **START/STOP** key. The save symbol appears (floppy disk showing the number of measured values stored to buffer memory) and prompts you to save the measured values to an ID number. 

- ⇨ Read the measured values and compare them with the table of permissible limit values.
- ⇨ Press the **ESC** key in order to discard the measured values stored to buffer memory and acknowledge by pressing the key shown at the right. 

Test Sequence with AT3-III E Adapter



Attention!

Please observe the operating instructions for the AT3-III E regarding correct connection of the test adapter and the device under test, as well as peculiarities involved in the test sequence.

Test Sequence with Differential Current Method

- ⇨ Prior to all leakage current measurements, please make sure that the measurement parameters „Ref. voltage L-PE“ and „Testingfreq. Alt“ have been correctly set in the SETUP, see section 6.2.
- ⇨ Set the rotary switch to the **I_{PE}** position.
- ⇨ Select the **Differential** measurement type:
 - By setting the parameters
 - or
 - Directly by pressing the key shown at the right
- ⇨ Connect the DUT's mains plug (protection class I) to the test instrument's test socket.
- ⇨ **Start the test:** press the **START/STOP** key.
- ⇨ The measurement must be performed with mains plug polarity in both directions by pressing the **NL/LN** key.
- ⇨ Acknowledge the warning which indicates that line voltage will be connected to the test socket.
- ⇨ Switch the device under test on.
- ⇨ The measured values are displayed. The measured value recording symbol shown at the right appears. Each time this key is pressed, the currently displayed measured value is saved to the buffer.
- ⇨ Turn off the device under test.
- ⇨ **Stop the test:** press the **START/STOP** key. The save symbol appears (floppy disk showing the number of measured values stored to buffer memory) and prompts you to save the measured values to an ID number.
- ⇨ Read the measured values and compare them with the table of permissible limit values.
- ⇨ Press the **ESC** key in order to discard the measured values stored to buffer memory and acknowledge by pressing the key shown at the right.



Maximum Permissible Limit Values for Leakage Current in mA

Test Standard	I _{PE}
VDE 0701-0702:2008	PC I: 3.5 1 mA/kW *
DIN EN 60974-4 VDE 0544-4:2009-06	5 mA

* For devices with heating power of greater than 3.5 kW

Note 1: Devices which are not equipped with accessible parts that are connected to the protective conductor, and which comply with requirements for touch current and, if applicable, patient leakage current, e.g. computer equipment with shielded power pack

Note 2: Permanently connected devices with protective conductor

Note 3: Portable X-ray devices with mineral insulation

Key

I_{PE} Current in the protective conductor (primary leakage current)

Test Sequence for Alternative Measuring Method

- ⇨ Prior to all leakage current measurements, please make sure that the measurement parameters „Ref. voltage L-PE“ and „Testingfreq. Alt“ have been correctly set in the SETUP, see section 6.2.
- ⇨ Set the rotary switch to the **I_{PE}** position.
- ⇨ Select the **Alternative** measurement type:
 - By setting the parameters
 - or
 - Via the **MA** key
- ⇨ Connect the DUT's mains plug (protection class I) to the test instrument's test socket.
- ⇨ **Start the test:** press the **START/STOP** key.
- ⇨ Switch the device under test on.
- ⇨ The measured values are displayed. The measured value recording symbol shown at the right appears. Each time this key is pressed, the currently displayed measured value is saved to the buffer.
- ⇨ **Stop the test:** press the **START/STOP** key. The save symbol appears (floppy disk showing the number of measured values stored to buffer memory) and prompts you to save the measured values to an ID number.
- ⇨ Read the measured values and compare them with the table of permissible limit values.
- ⇨ Press the **ESC** key in order to discard the measured values stored to buffer memory and acknowledge by pressing the key shown at the right.



8.7.2 Touch Current – IB

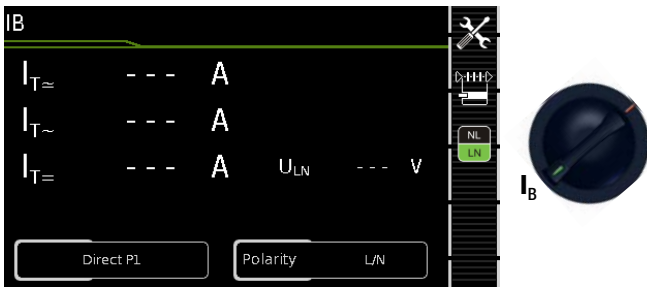

Single measurements, rotary switch level: green

Switch Position	Measurement Type, With Mains to Test Socket	Measurement Type, Without Mains to Test Socket	Measuring Functions
I _c	Direct P1		I _B ≈ Touch current, RMS I _{B~} AC component I _{B=} DC component U _{LN} Test voltage
	Differential P1		I _B ≈ Touch current, RMS U _{LN} Test voltage
		Alternative P1	I _B ≈ Touch current, RMS U _{LN} Test voltage
		Permanent connection P1	I _B ≈ Touch current, RMS I _{B~} AC component I _{B=} DC component
		Alternative P1–P2	I _B ≈ Touch current, RMS U _{LN} Test voltage

Applications

Make sure that the contacted parts are not grounded.

Definition

Current which flows from housing parts which are not connected to the protective conductor via an external conductive connection to earth or another part of the housing. Flow of current via the protective conductor is excluded in this case.

The following designations are also common:
housing leakage current, probe current.

Direct Measuring Method

- Direct measurement type P1
- DUT mains plug to test socket
- Test probe P1 to P1 terminals

Schematic Diagram

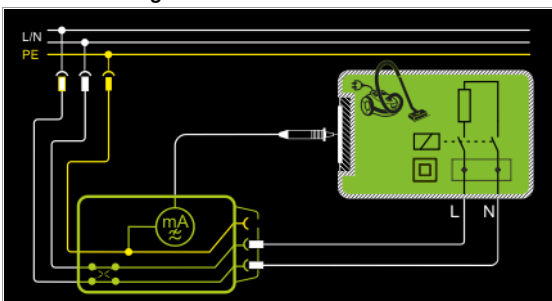

The device under test is operated with mains power. Current which flows to the protective conductor via exposed conductive parts is measured by means of the probe. The measurements must be performed with mains plug polarity in both directions. Polarity is reversed with the **NL/LN** key. The RMS, the AC or the DC component of the current is measured.

Wiring Diagram

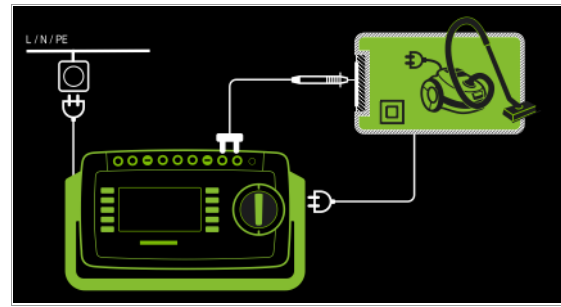

Note

regarding protection class I DUTs:

Parts may or may not be grounded.

Coincidental grounding only occurs in the event of an error.

Differential Current Method

- Differential measurement type P1
- DUT mains plug to test socket
- Test probe P1 to P1 terminals

Schematic Diagram

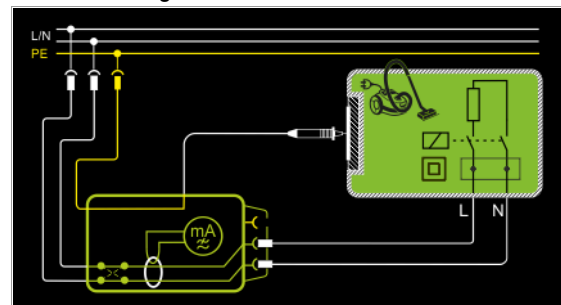

The device under test (PC2) is operated with mains power. Differential current which flows via the two mains conductors is measured (current clamp measurement concept). The measurements must be performed with mains plug polarity in both directions. Polarity is reversed with the **NL/LN** key. The current's AC component is measured. Accessible conductive parts must be contacted with test probe P1.

Wiring Diagram

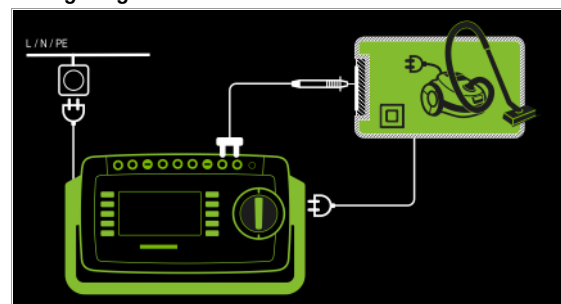

Alternative Measuring Method (equivalent leakage current)

- Alternative measurement type P1
- DUT mains plug to test socket
- Test probe P1 to P1 terminals

Schematic Diagram

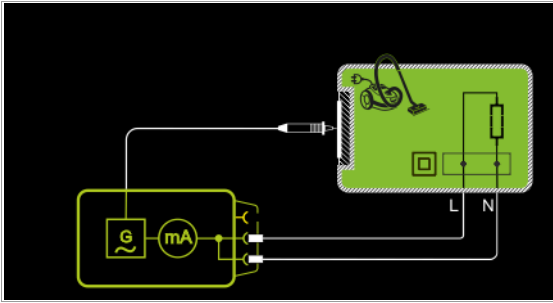

After activating test voltage, leakage current is measured between short-circuited mains conductors L and N (DUT mains plug) and accessible conductive parts (probe contact). The RMS, the AC or the DC component of the current is measured.

Wiring Diagram

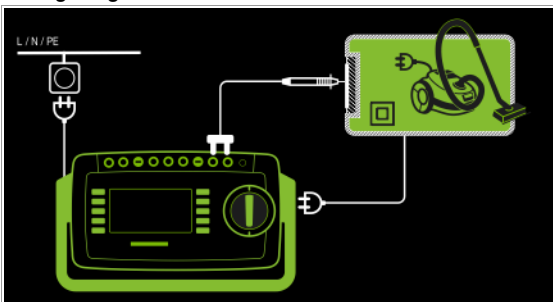

Direct Measuring Method for Permanently Installed DUTs

- Permanent connection measurement type P1
- Test probe P1 to P1 terminals

Schematic Diagram

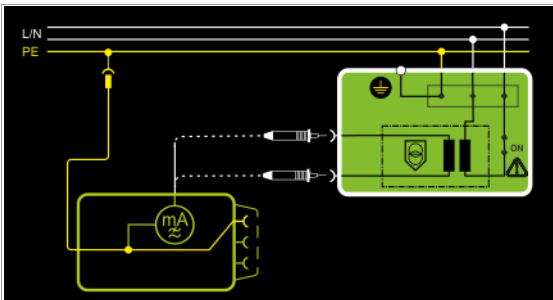

The DUT is operated with line voltage from a permanent installation. Leakage current is measured between the protective conductor at the mains and the output sockets for safety extra-low voltage at the DUT, one after the other, with the help of the test probe. Furthermore, accessible, conductive parts which are not connected to the housing must also be contacted.

Wiring Diagram

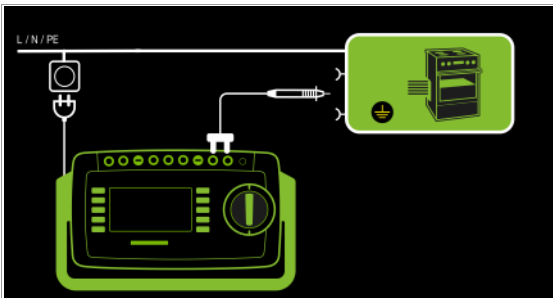

Alternative measuring method with 2-pole measurement (P1–P2)

- Alternative measurement type P1 - P2
- Test probe P1 to P1 terminals
- Test probe P2 to P2 terminals

Schematic Diagram

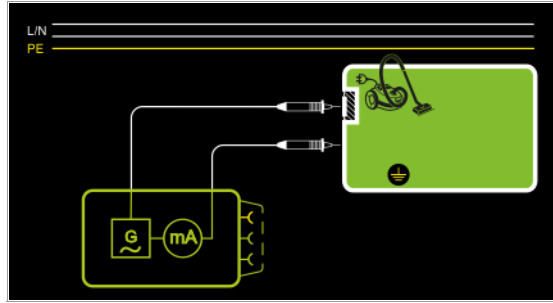

Insulation resistance is measured between external conductive parts which can be contacted with test probe P2 and are not connected to the housing, and the housing with test probe P1.

Wiring Diagram

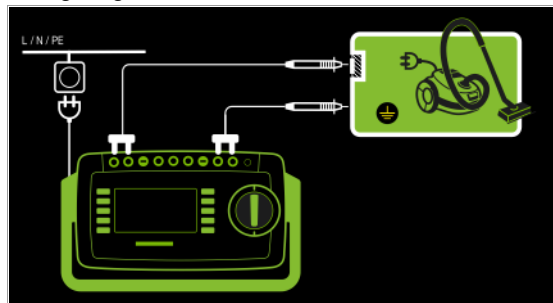

Setting Measuring Parameters for IB



Measuring Parameter	Meaning	
Measurement Type,		Suitable for DUT Connection via
Direct P1	Direct Measuring Method	Test socket, AT3 adapter (AT3-IIE, AT3-IIS, AT3-IIS32), AT16DI/AT32DI
Differential P1	Differential current measurement	Test socket
Alternative P1	Equivalent leakage current method	Test socket, AT3 adapter (AT3-IIE, AT3-IIS, AT3-IIS32), AT16DI/AT32DI, VL2E
Permanent connection P1	Permanently installed DUT	Permanent connection
Alternative P1–P2	Equivalent leakage current method with SECUTEST PRO or feature H01	No connection, PC3: 2-pole measurement between test probes 1 and 2 (see section 6.6)
Polarity – for direct and differential measurement types only		
L/N or N/L	Selection of polarity for mains voltage to the test socket	
The measuring parameters of measuring type „Alternative“ U(setpoint) and frequency(setpoint) are no longer included as from firmware version 1.7.0. These parameters apply to individual measurements as well as test sequences and have to be entered in the SETUP, see section 6.2		
U(set) – for alternative measurement type P1 only		
110 V, 115 V, 220 V, 230 V, 240 V	Selection of a line voltage for synthetic test voltage	
Frequency (set) – for alternative measurement type P1 only		
48 Hz ... 400 Hz	Selection of a line frequency for synthetic test voltage	

Direct Selection – Setting Polarity – for Direct and Differential Only



Measuring Parameter	Meaning
Measurement Type,	
L/N or N/L	Selection of polarity for mains voltage to the test socket

Prerequisites for Touch Current Measurement

- Visual inspection has been passed.
- For protection class I devices: protective conductor resistance testing has been passed.
- Insulation resistance testing has been passed.





Test Sequence for Direct and Differential Current Methods

- ⇨ Prior to all leakage current measurements, please make sure that the measurement parameters „Ref. voltage L-PE“ and „Testingfreq. Alt“ have been correctly set in the SETUP, see section 6.2.
- ⇨ Set the rotary switch to the I_B position.
- ⇨ Select the **Direct P1** or **Differential P1** measurement type:
 - by setting the parameters
 - or
 - via the **MA** key
- ⇨ In the case of **direct and differential current measurement**, measurement must be performed with mains plug polarity in both directions. Select the respective polarity to this end by pressing the **NL/LN** key. 
- ⇨ Connect the DUT's mains plug (protection class II) to the test instrument's test socket.







Attention!

Testing is conducted in the presence of line voltage.

- ⇨ **Start the test:** press the **START/STOP** key. 
- ⇨ Acknowledge the warning which indicates that line voltage will be connected to the test socket. 
- ⇨ Contact all accessible conductive parts, one after the other, which are not connected to the housing with test probe P1.
- ⇨ The measured values are displayed. The measured value recording symbol shown at the right appears. Each time this key is pressed, the currently displayed measured value is saved to the buffer. 
- ⇨ **Stop the test:** press the **START/STOP** key. The save symbol appears (floppy disk showing the number of measured values stored to buffer memory) and prompts you to save the measured values to an ID number. 
- ⇨ Read the measured values and compare them with the table of permissible limit values.
- ⇨ Press the **ESC** key in order to discard the measured values stored to buffer memory and acknowledge by pressing the key shown at the right. 

Test Sequence for Alternative Measuring Method

- ⇨ Prior to all leakage current measurements, please make sure that the measurement parameters „Ref. voltage L-PE“ and „Testingfreq. Alt“ have been correctly set in the SETUP, see section 6.2.
- ⇨ Set the rotary switch to the I_B position.
- ⇨ Select the **Alternative P1** measurement type:
 - by setting the parameters 
 - or
 - directly by pressing the key shown at the right
- ⇨ Connect the DUT's mains plug (protection class II) to the test instrument's test socket.
- ⇨ **Start the test:** press the **START/STOP** key. 
- ⇨ Contact all accessible conductive parts, one after the other, which are not connected to the housing with test probe P1.
- ⇨ The measured values are displayed. The measured value recording symbol shown at the right appears. Each time this key is pressed, the currently displayed measured value is saved to the buffer. 
- ⇨ **Stop the test:** press the **START/STOP** key. The save symbol appears (floppy disk showing the number of measured values stored to buffer memory) and prompts you to save the measured values to an ID number. 
- ⇨ Read the measured values and compare them with the table of permissible limit values.
- ⇨ Press the **ESC** key in order to discard the measured values stored to buffer memory and acknowledge by pressing the key shown at the right. 

Maximum Permissible Limit Values for Leakage Current in mA

Test Standard	I_C
VDE 0701-0702:2008	0.5
DIN EN 60974-4 VDE 0544-4:2009-06	10 mA

Key

I_B Touch current (leakage current from welding current)

8.7.3 Device Leakage Current – IG

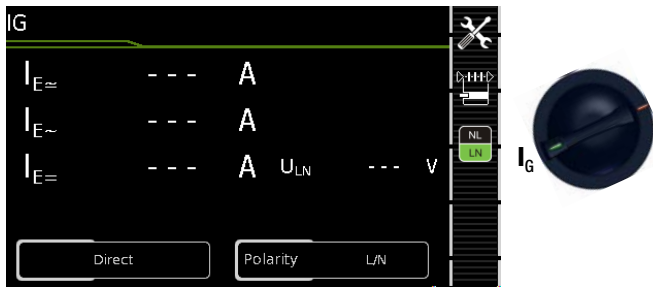

Single measurements, rotary switch level: green

Switch Position	Measurement Type, With Mains to Test Socket	Measurement Type, Without Mains to Test Socket	Measuring Functions
I _G	Direct		I _G ≈ Device leakage current, RMS I _{G~} AC component I _{G=} DC component U _{LN} Test voltage
	Differential		I _G ≈ Device leakage current, RMS U _{LN} Test voltage
	Alternative		I _G ≈ Device leakage current, RMS U _{LN} Test voltage
	AT3 adapter ¹		I _G ≈ Device leakage current, RMS U _{LN} Test voltage
	Clamp ²		I _G ≈ Device leakage current, RMS U _{LN} Test voltage

¹ Adapter AT3-IIIIE, AT3-IIS or AT3-II S32:

Voltage measuring inputs for leakage current measurement with differential method with **SECUTEST PRO** only (or instrument with feature I01)

² Voltage measuring inputs for leakage current measurement with differential method using a current clamp sensor, with **SECUTEST PRO** only (or instrument with feature I01)

Applications

Measurement of device leakage current is required for electrical medical devices in accordance with IEC 62353 (VDE 0751-1).

In the case of device leakage current as the sum of all leakage current, all probe contact points must be contacted simultaneously.

Definition

Device leakage current is the sum of all leakage currents from the housing, accessible conductive parts and applied parts to PE.

Direct Measuring Method

- Direct measurement type
- DUT mains plug to test socket
- Test probe P1 to P1 terminals

Schematic Diagram

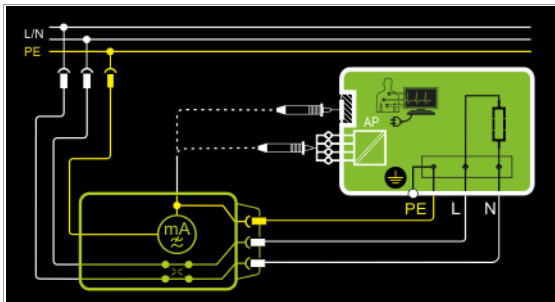

The device under test (PC1) is operated with mains power. Protective conductor current is measured between the protective conductor at the mains (test instrument supply power) and the protective conductor terminal at the DUT via the DUT's mains cable. The measurements must be performed with mains plug polarity in both directions. Polarity is reversed with the **NL/LN** key. Accessible conductive parts which are connected to the housing, as well as those which are not connected to the housing, must be

contacted with test probe P1.

If the DUT includes terminals for applied parts, they must be short-circuited and contacted with test probe P1 as well.

Wiring Diagram

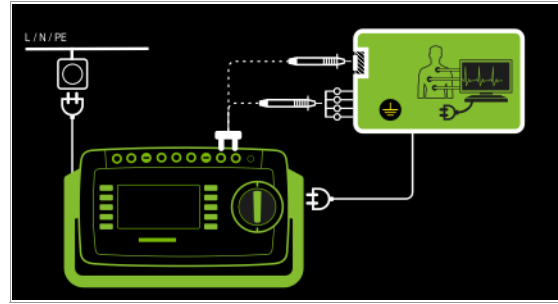

Differential Current Measurement

- Differential measurement type
- DUT mains plug to test socket
- Test probe P1 to P1 terminals

Schematic Diagram, Protection Class I

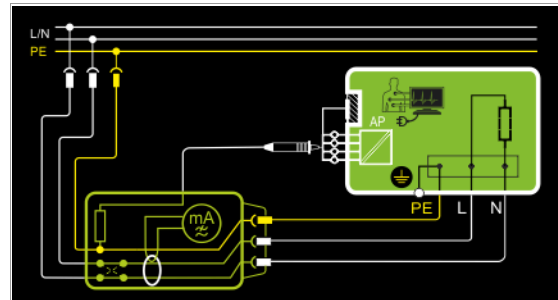

The device under test (PC1) is operated with mains power. Differential current which flows via the two mains conductors is measured (current clamp measurement concept). The measurements must be performed with mains plug polarity in both directions. Polarity is reversed with the **NL/LN** key.

Short-circuited terminals for applied parts or accessible conductive parts which are not connected to the housing must be contacted with test probe P1.

Wiring Diagram, Protection Class I

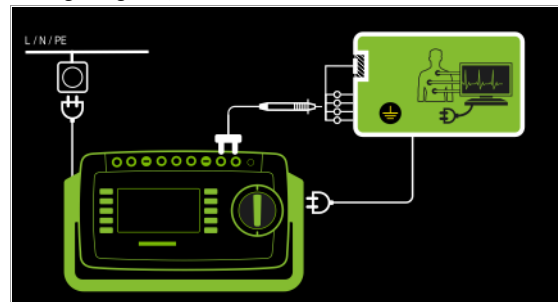

Wiring Diagram, Protection Class II

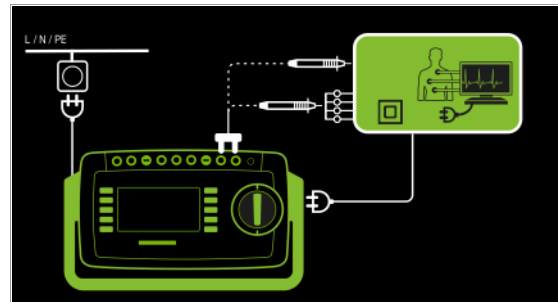

Alternative Measuring Method (equivalent leakage current)

- *Alternative Measurement Type (P1)*
- DUT mains plug connected to the test socket
- Test probe P1 to P1 terminals

Schematic Diagram, Protection Class I

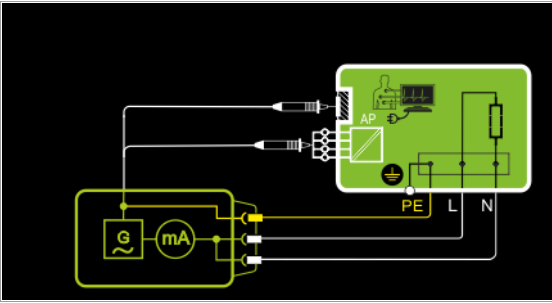

After activating test voltage, leakage current is measured between short-circuited mains conductors L and N (DUT mains plug) and accessible conductive parts (probe contact) which **are not connected to the housing**.

If the DUT includes terminals for applied parts, they must be short-circuited and contacted with test probe P1 as well.

Wiring Diagram, Protection Class I

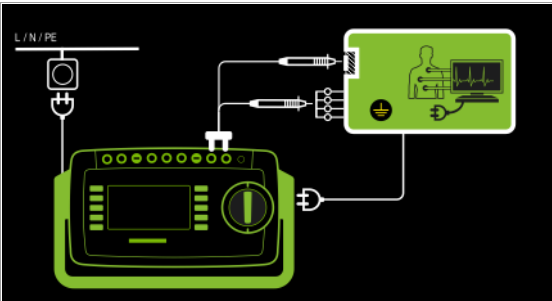

Differential Current Measurement

- *AT3-Adapter measurement type*
- DUT mains plug to AT3-IIIIE test adapter
- Test probe P1 to P1 terminals
- AT3-IIIIE probe to COM-V terminals
- AT3-IIIIE test plug to test socket

Schematic Diagram

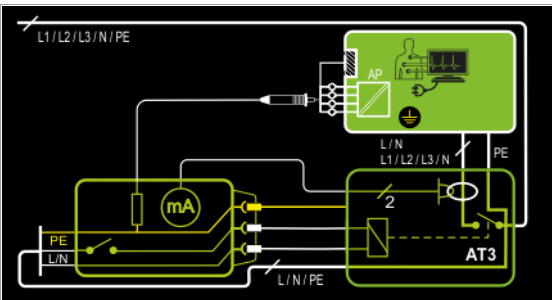

Measurement at the DUT with 3-phase mains connection via AT3-IIIIE adapter

Wiring Diagram

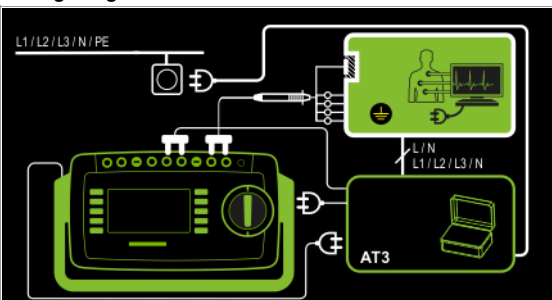

Measurement Method with Current Clamp Sensor for Permanently Installed DUTs

- *Clamp measurement type*
- Clamp to COM-V (only with SECUTEST PRO or featureI01 with optional WZ12C current clamp sensor)

Schematic Diagram

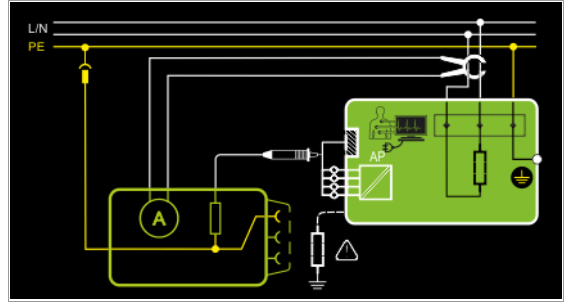

Measurement of device leakage current by closing the current clamp sensor around the L and N conductors in the power cable of the mains for permanently installed protection class I devices under test

Wiring Diagram

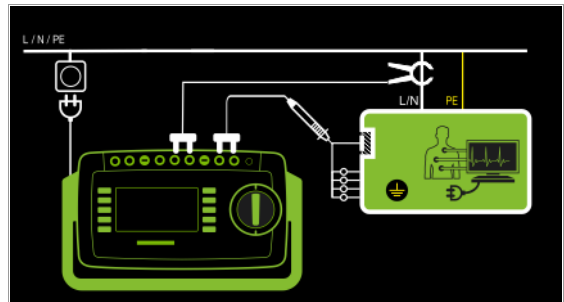

Set Measuring Range at Current Clamp Sensor and Parameter at the SECUTEST PRO

SECUTEST PRO Transformer Ratio Parameter	Current Clamp Sensor Transformer Ratio (Switch*)	Measuring Range	SECUTEST PRO Display Range with Clamp
1 : 1	WZ12C		0 mA ... 300 A
	1 mV : 1 mA	1 mA... 15 A	
100 : 1	SECUTEST CLIP		0.00 mA ... 3.00 A
	100 mV : 1 mA	0.1...25 mA	

* only with WZ12C









Setting Measuring Parameters for IG



Measuring Parameter	Meaning	
Measurement Type		Suitable for DUT Connection via
Direct	Direct measuring method, optional probe contact	Test socket, AT16DI/AT32DI (only diff. is sensible)
Differential	Differential current measurement	Test socket
Alternative	Equivalent leakage current measuring method with probe contact	Test socket, AT16DI/AT32DI
AT3 adapter	SECUTEST PRO or feature I01: measurement with AT3 adapter	AT3-III E, AT3-IIS, AT3-IIS32
Clamp	SECUTEST PRO or feature I01: Measurement of device leakage current via current clamp sensor with voltage output, and conversion to and display as current values.	Permanent connection
Polarity ¹ – for direct, differential and AT3 adapter measurement types only		
L/N or N/L	Selection of polarity for mains voltage to the test socket	
The measuring parameters of measuring type „Alternative“ U(setpoint) and frequency(setpoint) are no longer included as from firmware version 1.7.0. These parameters apply to individual measurements as well as test sequences and have to be entered in the SETUP, see section 6.2		
U(set) – for alternative measurement type only		
110 V, 115 V, 220 V, 230 V, 240 V	Selection of a line voltage for synthetic test voltage	
Frequency(set) – for alternative measurement type only		
48 Hz ... 400 Hz	Selection of a line frequency for synthetic test voltage	
Clamp factor – only for clamp measurement type		
1:1	Transformer ratio of the current clamp sensor WZ12C . For setting the current clamp factor at the clamp WZ12C and the SECUTEST PRO (see table above).	
100:1	Transformer ratio of the current clamp sensor SECUTEST CLIP . For setting the current clamp factor at the SECUTEST PRO .	

¹ Measurement must be performed with mains polarity in both directions. The largest value is documented

Test Sequence

- Prior to all leakage current measurements, please make sure that the measurement parameters „Ref. voltage L-PE“ and „Testingfreq. Alt“ have been correctly set in the SETUP, see section 6.2.
- Set the rotary switch to the **I_G** position.
- Connect the DUT in accordance with the selected measuring method.
- Set the parameters:
Select the **Direct**, **Differential** or **Alternative** measurement type.
- As an alternative, you can select the measurement type directly using the key shown at the right. 
- In the case of **direct and differential current measurement**, measurement must be performed with mains plug polarity in both directions. Select the respective polarity to this end by pressing the **NL/LN** key. 
- Start the test: press the **START/STOP** key. 
- After each reconnection to the mains, and as soon as the first test is started, a mains connection test is executed.
- **In the case of the direct or differential measurement type:** acknowledge the warning which indicates that line voltage will be connected to the test socket. 
- The measured values are displayed. The measured value recording symbol shown at the right appears. Each time this key is pressed, the currently displayed measured value is saved to the buffer. 
- **Stop the test:** press the **START/STOP** key. The save symbol appears (floppy disk showing the number of measured values stored to buffer memory) and prompts you to save the measured values to an ID number. 
- Read the measured values and compare them with the table of permissible limit values. 
- Press the **ESC** key in order to discard the measured values stored to buffer memory and acknowledge by pressing the key shown at the right. 

Test Sequence with AT3-III E Adapter



Attention!

Please observe the operating instructions for the AT3-III E regarding correct connection of the test adapter and the device under test, as well as peculiarities involved in the test sequence.

Maximum Allowable Limit Values for Equivalent Leakage Current in mA

Test Standard	I _{GA}	I _{EDL}
VDE 0701-0702	PC I: 3.5 / 1 mA/kW ¹ PC II: 0.5	
IEC 62353 (VDE 0751-1)		PC II 0.2 ²
		PC I (PE or parts connected to PE) 1
		Permanently connected devices with PE 10
		Portable x-ray devices with additional PE 5
		Portable x-ray devices without additional PE 2
		Devices with mineral insulation 5

I_{GA} Device leakage current

I_{EA} Equivalent leakage current

PE Protective conductor

¹ For devices with heating power ≥ 3.5 kW

² This limit value is not taken into consideration in the DIN EN 62353 (VDE 0751-1) standard.

8.7.4 Leakage Current from the Applied Part – IA

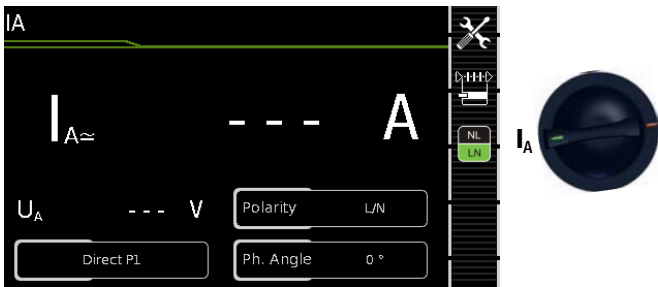

Single measurements, rotary switch level: green

Switch Position	Measurement Type, With Mains to Test Socket	Measurement Type, Without Mains to Test Socket	Measuring Functions
IA	Direct P1		IA ≈ Current from applied part UA Test voltage
		Alternative P1	
		Perm. con. P1	

Direct Measuring Method

- Direct measurement type P1
- DUT mains plug (PC1) connected to test socket
- Probe to P1 Terminal

Schematic Diagram

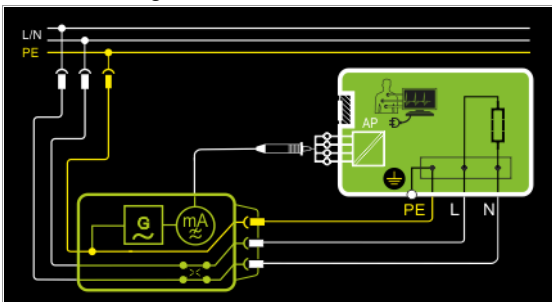

The device under test (PC1) is operated with mains power. The measurements must be performed with mains plug polarity in both directions. Polarity is reversed with the **NL/LN** key. After activating **test voltage** and **line voltage**, leakage current from the application part is measured between the short-circuited terminals of the applied parts and PE (DUT mains plug).

Wiring Diagram

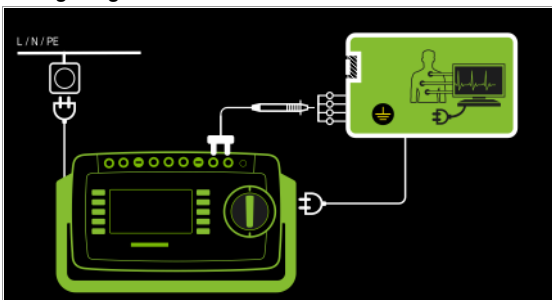

Alternative Measuring Method

(equivalent patient leakage current)

- Alternative Measurement Type P1
- DUT mains plug (PC1) connected to test socket
- Probe to P1 Terminal

Schematic Diagram

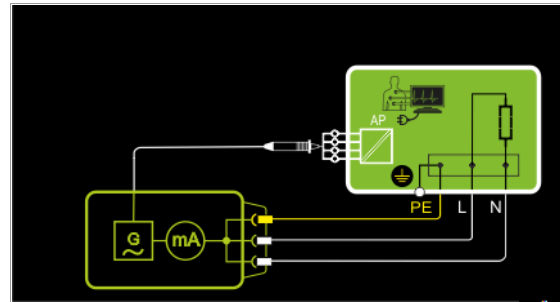

After activating test voltage, leakage current from the application part is measured between short-circuited conductors L-N-PE (DUT mains plug) and the short-circuited terminals of the applied parts.

Wiring Diagram

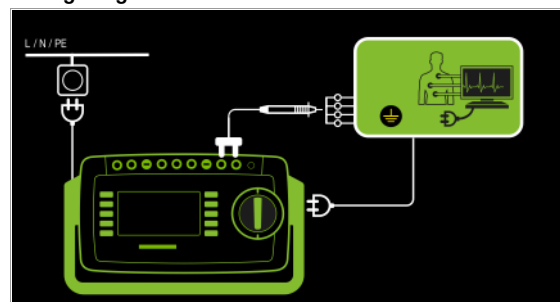

Direct Measuring Method

- Permanent connection measurement type P1
- Permanent connection
- Probe to P1 terminal

Schematic Diagram

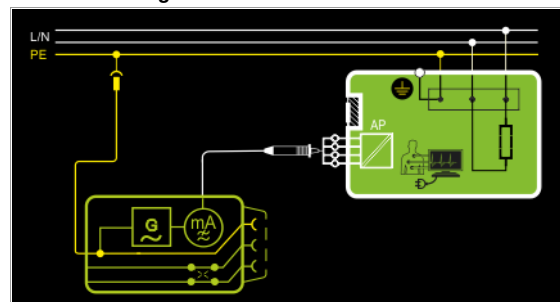

Leakage current from the application part is measured between the short-circuited terminals of the application parts and PE at the mains connection.

Wiring Diagram

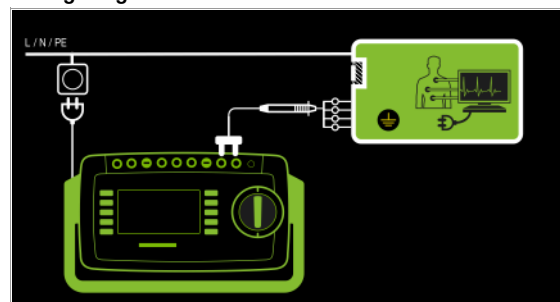

Setting Measuring Parameters for IA



Measuring Parameter	Meaning	
Measurement Type,	Suitable for DUT Connection via	
Direct P1	Direct measuring method (via test socket) with test probe P1	Test socket, AT3 adapter (AT3-IIIE, AT3-IIS, AT3-IIS32), AT16DI/AT32DI
Alternative P1	Equivalent leakage current measuring method (via test socket) with test probe P1	Test socket
Perm. con. P1	Direct measuring method	Permanent connection
Phase angle – for direct P1 and permanent connection P1 only		
0 ° or 180 °	Selectable phasing for the internal generator relative to mains phasing	
Polarity – for direct only P1		
L/N or N/L	Selection of polarity for mains voltage to the test socket	
The measuring parameters of measuring type „Alternative“ U(setpoint) and frequency (setpoint) are no longer included as from firmware version 1.7.0. These parameters apply to individual measurements as well as test sequences and have to be entered in the SETUP, see section 6.2		
U(set) – for alternative P1 and permanent connection P1 only		
110 V, 115 V, 220 V, 230 V, 240 V	Selection of a line voltage for synthetic test voltage	
Frequency(set) – for alternative only P1		
48 Hz ... 400 Hz	Selection of a line frequency for synthetic test voltage	

8.7.5 Patient Leakage Current – IP

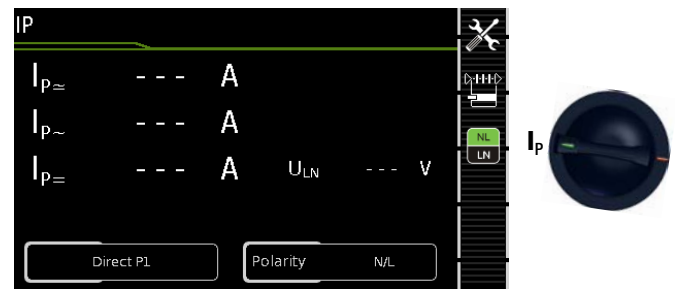







Single measurements, rotary switch level: green			
Switch Position	Measurement Type, With Mains to Test Socket	Measurement Type, Without Mains to Test Socket	Measuring Functions
Ip	Direct P1		IP~ Patient leakage current, RMS IP~ AC component IP= DC component ULN Test voltage
		Permanent connection P1	

Definition

Patient leakage current is the current which flows to ground or PE from the patient ports at the running device via the patient. The AC and the DC component of the current is measured.

Test Sequence

- Prior to all leakage current measurements, please make sure that the measurement parameters „Ref. voltage L-PE“ and „Testingfreq. Alt“ have been correctly set in the SETUP, see section 6.2.
- Set the rotary switch to the **IA** position.
- Connect the DUT in accordance with the selected measuring method.
- Set the parameters:
Select the **Direct P1** or **Alternative P1** measurement type:
- In the case of **direct measurement**, measurement must be performed with mains plug polarity in both directions. Select the respective polarity to this end by pressing the **NL/LN** key. 
- **Start the test:** press the **START/STOP** key. 
- After each reconnection to the mains, and as soon as the first test is started, a mains connection test is executed.
- **In the case of the direct measurement type P1:** acknowledge the warning which indicates that line voltage will be connected to the test socket. 
- Contact the short-circuited applied parts with the test probe.
- The measured values are displayed. The measured value recording symbol shown at the right appears. Each time this key is pressed, the currently displayed measured value is saved to the buffer. 
- **Stop the test:** press the **START/STOP** key. The save symbol appears (floppy disk showing the number of measured values stored to buffer memory) and prompts you to save the measured values to an ID number. 
- Read the measured values and compare them with the table of permissible limit values.
- Press the **ESC** key in order to discard the measured values stored to buffer memory and acknowledge by pressing the key shown at the right. 

Direct Measuring Method

- **Direct measurement type P1**
- **DUT mains plug (PC1) connected to test socket**
- **Probe to P1 terminal**

Schematic Diagram

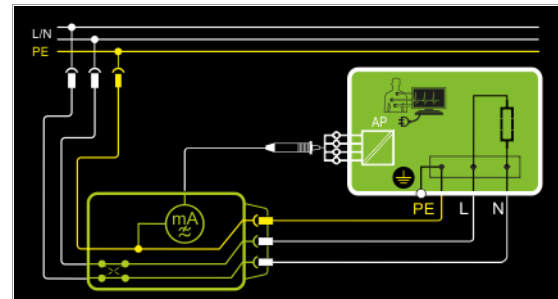

After activating test voltage, patient leakage current is measured at the DUT between PE (DUT mains plug) and the short-circuited application parts.

Wiring Diagram

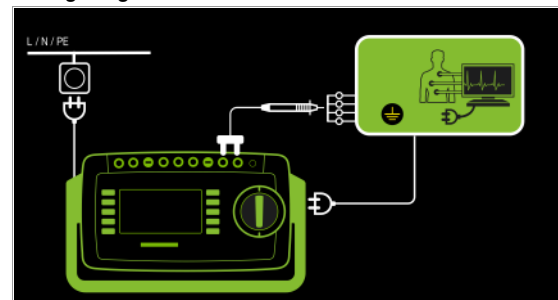

Direct Measuring Method

- Permanent connection measurement type P1
- Permanent connection
- Probe to P1 terminal

Schematic Diagram

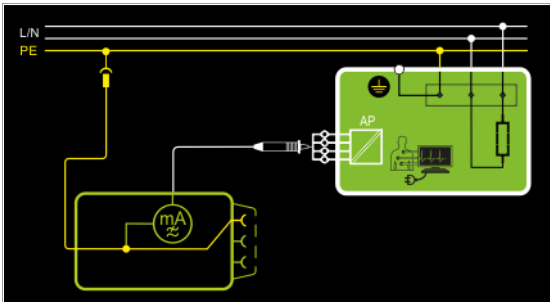

Patient leakage current is measured between the patient connections and PE of the mains connection.

Wiring Diagram

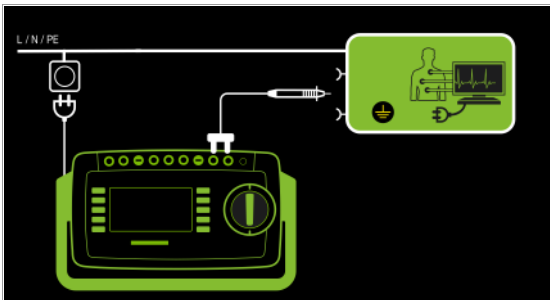







Setting Measuring Parameters for IP



Measuring Parameter	Meaning	
Measurement Type	Suitable for DUT Connection via	
Direct P1	Direct measuring method (via test socket) with test probe P1	Test socket
Perm. con. P1	Permanently installed DUT	Permanent connection
Polarity – for direct only P1		
L/N or N/L	Selection of polarity for mains voltage to the test socket	

Test Sequence

- Prior to all leakage current measurements, please make sure that the measurement parameters „Ref. voltage L-PE“ and „Testingfreq. Alt“ have been correctly set in the SETUP, see section 6.2.
- Set the rotary switch to the I_p position.
- Connect the DUT to the test socket.
- In the case of **direct measurement P1**, measurement must be performed with mains plug polarity in both directions. Select the respective polarity to this end by pressing the **NL/LN** key. 
- **Start the test:** press the **START/STOP** key. 
- After each reconnection to the mains, and as soon as the first test is started, a mains connection test is executed.
- Acknowledge the warning which indicates that line voltage will be connected to the test socket. 
- Contact the short-circuited inputs for the applied parts with test probe P1.
- The measured values are displayed. The measured value recording symbol shown at the right appears. Each time this key is pressed, the currently displayed measured value is saved to the buffer. 
- **Stop the test:** press the **START/STOP** key. The save symbol appears (floppy disk showing the number of measured values stored to buffer memory) and prompts you to save the measured values to an ID number. 
- Read the measured values and compare them with the table of permissible limit values.
- Press the **ESC** key in order to discard the measured values stored to buffer memory and acknowledge by pressing the key shown at the right. 

Maximum Allowable Limit Values for Leakage Current in mA

Test Standard		I_p		
		Type B	Type BF	Type CF
IEC 62353 (VDE 0751-1)	Direct current	0.01	0.01	0.01
	Alternating current	0.1	0.1	0.01
EN 60601	Direct current	0.01	0.01	0.01
	Alternating current	0.1	0.1	0.01

8.8 Probe Voltage – U



Single measurements, rotary switch level: green

Switch Position	Measurement Type, With Mains to Test Socket	Measurement Type, Without Mains to Test Socket	Measuring Functions
U		PE - P1	U_{\sim} Probe voltage, RMS Alt. voltage component U_{-} Direct voltage component
	PE - P1 (with mains)		U_{\sim} Probe voltage, RMS Alt. voltage component U_{-} Direct voltage component

Mains to Test Socket

Schematic Diagram

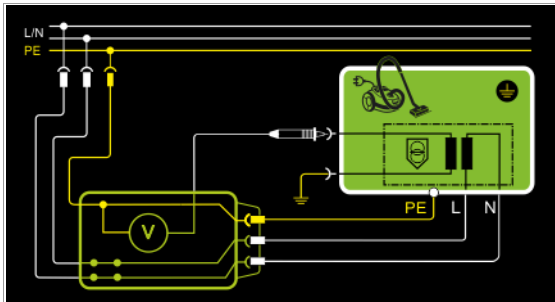

Wiring Diagram

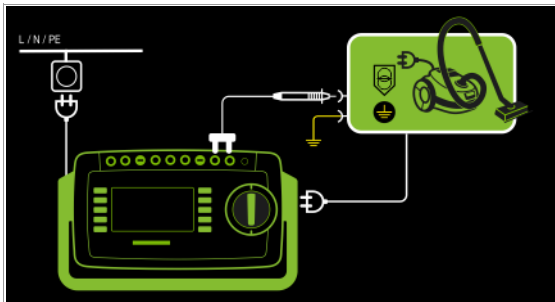

Permanently Connected DUT

Schematic Diagram

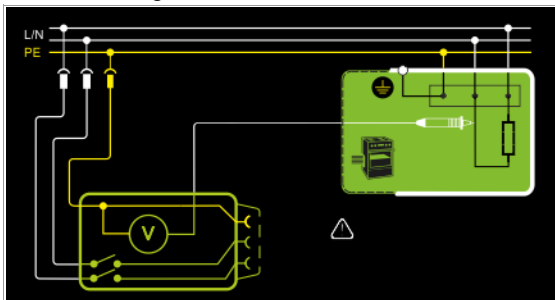

Wiring Diagram

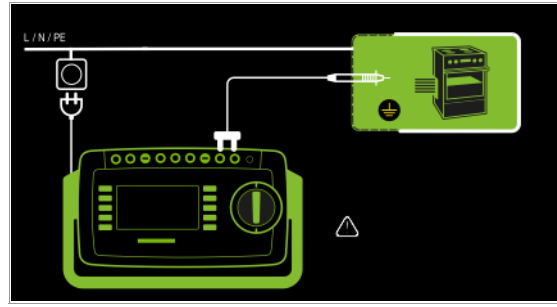

Direct, alternating and pulsating voltages of up to 253 V can be measured. Two connection types are available, one of which has to be selected in the parameters menu.

Setting Measuring Parameters for U_{Probe}



Measuring Parameter	Meaning	
Measurement Type,		Suitable for DUT Connection via
PE-P1	Measurement of voltages with reference to PE, test socket remains voltage-free	Permanent connection
PE-P1 (with mains)	Measurement of voltages with reference to PE, line voltage is applied to the test socket	Test socket
Polarity – only for PE-P1 (with mains)		
L/N or N/L	Selection of polarity for mains voltage to the test socket	

Test Sequence

- Set the rotary switch to the **U** position.
- Connect the DUT's mains plug to the test instrument's test socket.
- **Start the test:** press the **START/STOP** key.



- **PE-P1 (with mains):** Acknowledge the warning which indicates that line voltage will be connected to the test socket.



- Contact the ungrounded output for safety extra-low voltage with test probe P1.

- Polarity can be set via direct selection immediately before measurement is started, without having to switch to the parameters menu.



- The measured values are displayed. The measured value recording symbol shown at the right appears. Each time this key is pressed, the currently displayed measured value is saved to the buffer.



- **Stop the test:** press the **START/STOP** key. The save symbol appears (floppy disk showing the number of measured values stored to buffer memory) and prompts you to save the measured values to an ID number.



- Press the **ESC** key in order to discard the measured values stored to buffer memory and acknowledge by pressing the key shown at the right.



8.9 Measuring Voltage – U (with SECUTEST PRO or feature I01 only)

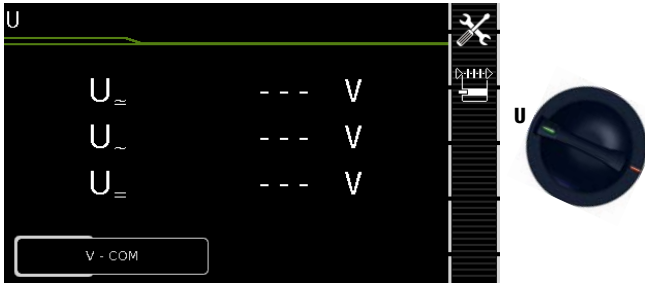

Single measurements, rotary switch level: green

Switch Position	Measurement Type, With Mains to Test Socket	Measurement Type, Without Mains to Test Socket	Measuring Functions
U		V – COM	U_{\sim} Measuring voltage, RMS U_{\sim} Alt. voltage component U_{-} Direct voltage component
	V – COM (with mains)		U_{\sim} Measuring voltage, RMS U_{\sim} Alt. voltage component U_{-} Direct voltage component

Mains to Test Socket

Schematic Diagram

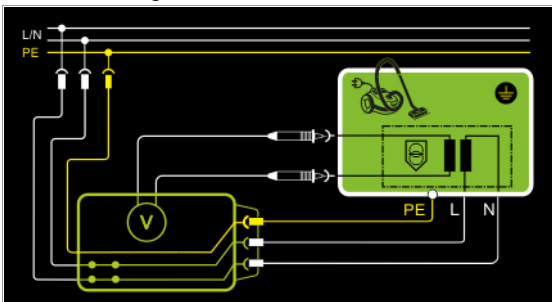

Wiring Diagram

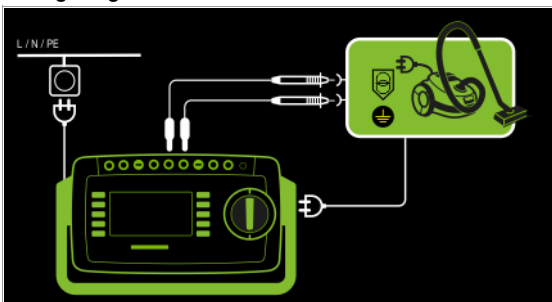

Permanently Connected DUT

Schematic Diagram

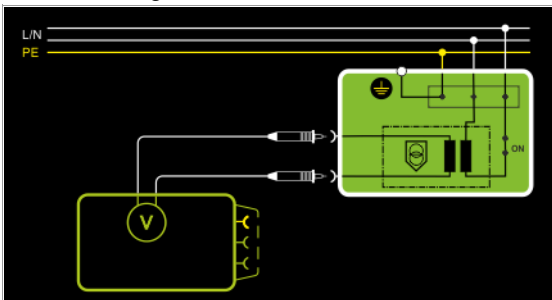

Wiring Diagram

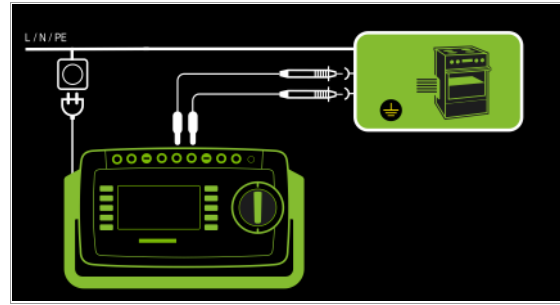

Direct, alternating and pulsating voltages of up to 253 V can be measured between the **V** and **COM** socket terminals.

- Measurements with the voltage measuring input of the voltmeter function (V–COM), electrically isolated from the mains

Setting Measuring Parameters



Measuring Parameter	Meaning	
Measurement Type,		Suitable for DUT Connection via
V – COM	Display: RMS value + AC + DC	Permanent connection
V – COM (with mains)	Display: RMS value + AC + DC; with mains to test socket, e.g. for measuring protective extra-low voltage at power packs	Test socket

Test Sequence, DUT at Test Socket (e.g. for measuring safety extra-low voltage at power packs or chargers)

- Set the rotary switch to the **U** position.
- Set the parameter to **V – COM (with mains)**.
- Connect the DUT's mains plug to the test instrument's test socket.



Attention!

Use only the included, contact-protected KS17-ONE measurement cables when measuring dangerous voltage.

- Connect the DUT's output sockets to the **V** and **COM** sockets, e.g. in order to be able to measure a **safety extra-low voltage** at the DUT's output.



Attention!

The voltage measured at the output of the DUT must be a safety extra-low voltage which is electrically isolated from the mains, because any overcurrent protective device included in the installation might otherwise be tripped.

- Start the test:** press the **START/STOP** key.



- PE-P1 (with mains):** Acknowledge the warning which indicates that line voltage will be connected to the test socket.



- The measured values are displayed. The measured value recording symbol shown at the right appears. Each time this key is pressed, the currently displayed measured value is saved to the buffer.



- Stop the test:** press the **START/STOP** key. The save symbol appears (floppy disk showing the number of measured values stored to buffer memory) and prompts you to save the measured values to an ID number.



- Press the **ESC** key in order to discard the measured values stored to buffer memory and acknowledge by pressing the key shown at the right.



8.10 Measuring Time to Trip for RCDs of the Type PRCD – t_A

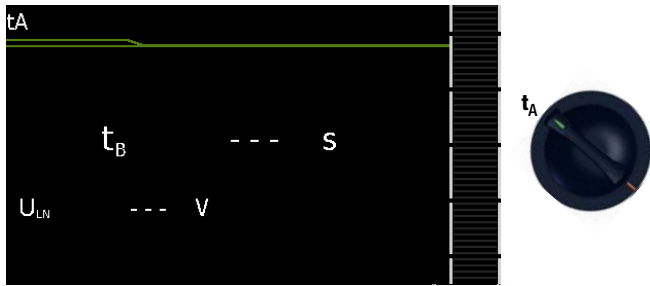

Single measurements, rotary switch level: green

Switch Position	Measuring Functions	Measurement Type, With Mains to Test Socket
t_A	t_a PRCD time to trip for 30 mA PRCD	
	U_{LN} Line voltage at the test socket	

Test Sequence

- Set the rotary switch to the t_A position.
- Plug the PRCD into the test socket at the test instrument and connect the test probe to P1.
- **Start the test:** press the **START/STOP** key.
- Acknowledge the warning which indicates that line voltage will be connected to the test socket.



Execute the following steps when prompted to do so:



Note

Please note that test probe P1 is in continuous contact with the phase conductor from the point in time at which the PRCD is plugged in until it trips. Premature disconnection of the test probe may result in erroneous measured values.

Schematic Diagram

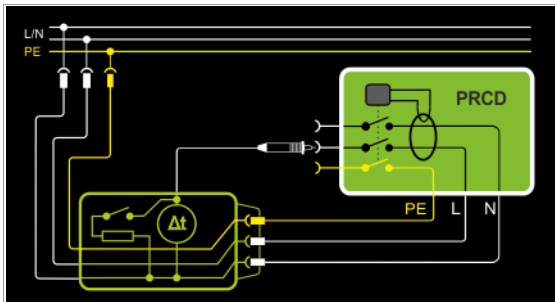

Wiring Diagram

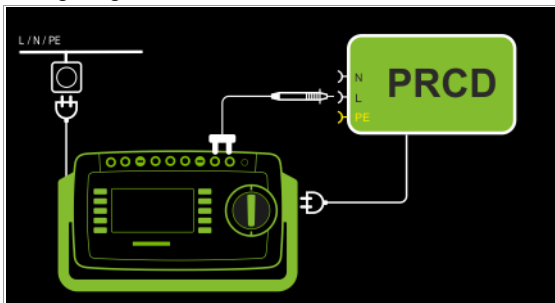

- After each reconnection to the mains, and as soon as the first test is started, a mains connection test is executed.
- If the probe test has revealed that probe P1 was not connected: connect probe P1 as described above.
- Switch the PRCD on after connection to line voltage (e.g. reset button on PRCD).
- Contact neutral conductor L at the PRCD with test probe P1 (ascertain by trial and error if necessary).
- The test is automatically ended and time to trip is displayed after the PRCD is tripped.
- The save symbol appears and prompts you to save the measured values to an ID number.
- Press the **ESC** key in order to discard the measured values stored to buffer memory and acknowledge by pressing the key shown at the right.



Definition

According to DIN VDE 0100-600:2008, substantiation must be provided that the RCCB is tripped within the time span defined by DIN VDE 0100-410.

PRCD Portable residual current device

Applications

The PRCD under test is plugged into the test socket at the test instrument. The PRCD's phase conductor must be contacted with test probe P1 in order to trip the PRCD.



Note

The testing of PRCDs (test sequences and time to trip) is only possible for DUTs with a nominal voltage of 230 V.



Note

Measurement of time to trip is not possible in IT systems.

8.11 Function Test – P

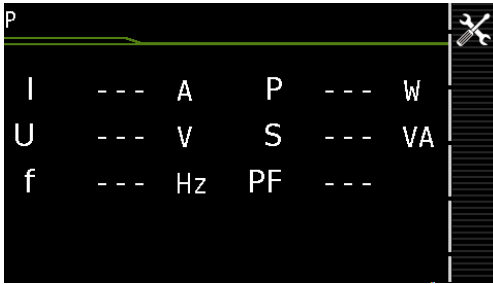

Single measurements, rotary switch level: green

Switch Position	Measuring Functions	Measurement Type, With Mains to Test Socket
P	Function test at the test socket	Selection of polarity for mains voltage
I	Current between L and N	
U	Voltage between L and N	
f	Frequency	
P	Active power	
S	Apparent power	
PF	Power factor	

Schematic Diagram

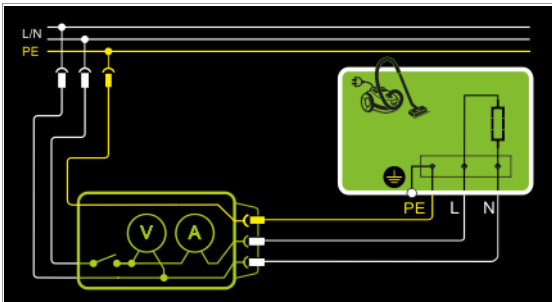

Wiring Diagram

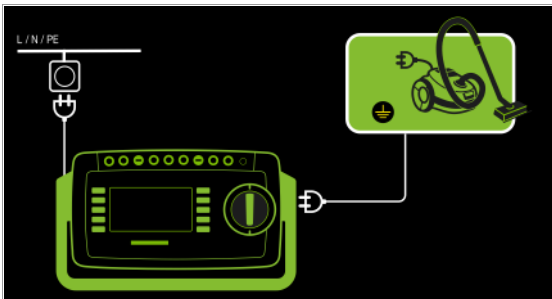

Setting Measuring Parameters for P

Measuring Parameter	Meaning
Polarity	
LN	Phase L – neutral conductor N
NL	Neutral conductor N – phase L

The following connection types are possible:

- Test socket
- CEE adapter (only for connection via single-phase CEE or “caravan socket”)
- AT3 adapter (AT3-IIIIE, AT3-IIS, AT3-IIS32)
- AT16DI/AT32DI



Note

These or similar adapters can be used for the function test (initial start-up of the DUT), but measurement of apparent and active power, power factor and current consumption is only possible when the DUT is directly connected to the test socket or via the CEE adapter (single-phase CEE socket only).

The device under test can be subjected to a function test with mains voltage via the integrated test socket.

The test socket is tested for short-circuiting before switching to line voltage (a statement resulting from the short-circuit test can only be made regarding the DUT itself when a single-phase DUT is being tested).

In addition to testing with the selector switch in the function test position, a function test can also be performed immediately after safety testing has been passed in accordance with the selected standard (not possible for protection class III devices).

Test Sequence



Attention!

The function test may only be performed after the DUT has successfully passed the safety test.



Attention!

Refer to the safety precautions on page 5 with regard to **switching power consumers**.



Attention!

Starting the Function Test

For reasons of safety, the device under test must be switched off before the function test is started. This precaution prevents inadvertent start-up of a DUT which may represent a hazard during operation, e.g. a circular saw or a disc grinder.

Ending the Function Test

After completion of the function test, DUTs must be turned off with their own switch – especially devices with relatively high inductivity.

- ⇨ Set the rotary switch to the **P** position.
- ⇨ Connect the DUT's mains plug to the test instrument's test socket.
- ⇨ **Start the test:** press the **START/STOP** key.



- ⇨ Acknowledge the warning which indicates that line voltage will be connected to the test socket.



- ⇨ The measured values are displayed. The measured value recording symbol shown at the right appears. Each time this key is pressed, the currently displayed measured value is saved to the buffer.



- ⇨ **Stop the test:** press the **START/STOP** key. The save symbol appears (floppy disk showing the number of measured values stored to buffer memory) and prompts you to save the measured values to an ID number.



- ⇨ Press the **ESC** key in order to discard the measured values stored to buffer memory and acknowledge by pressing the key shown at the right.



8.12 Testing Extension Cords – EL1

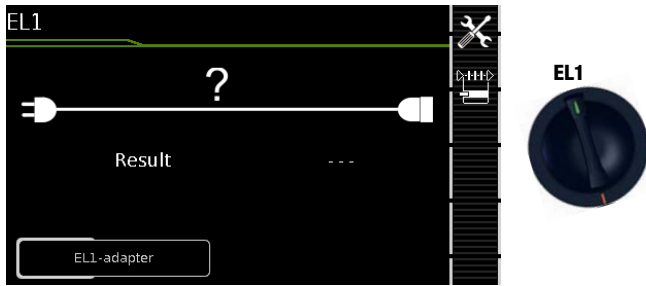

Single measurements, rotary switch level: green

Switch Position	Measuring Functions	Measurement Type, Without Mains to Test Socket
EL1	Extension cord test with adapter for single or 3-phase extension cords for testing: – Continuity – Short-circuit – Incorrect polarity (reversed wires)	EL1 adapter AT3-III-E adapter VL2E adapter

* No checking for reversed polarity takes place when the EL1 adapter is used.

Measurement at Single and 3-Phase Extension Cords with VL2E

Schematic Diagram

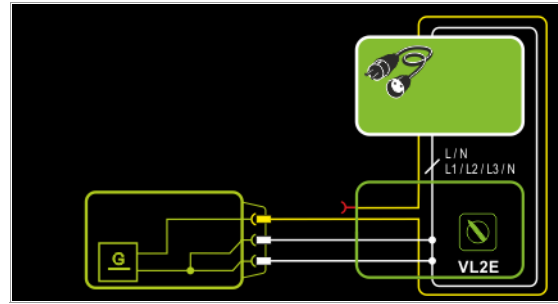

Wiring Diagram

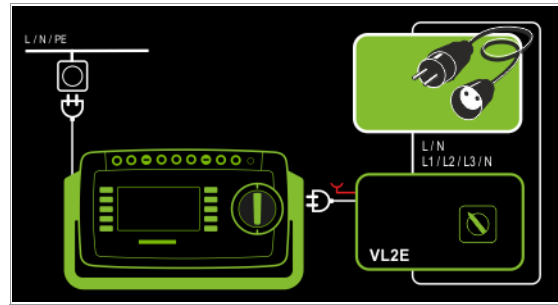

Measurement at Single-Phase Extension Cords with EL1

Schematic Diagram

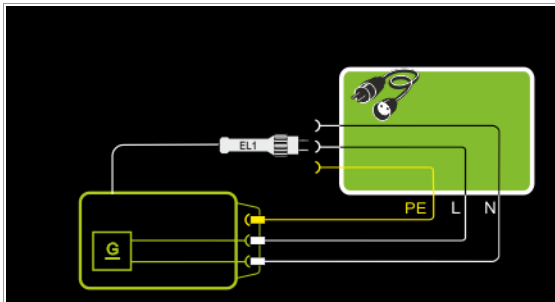

Wiring Diagram

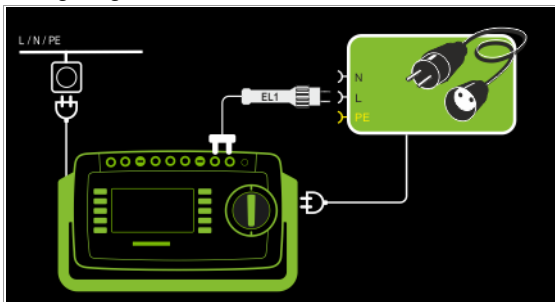

Measurement at Single and 3-Phase Extension Cords with AT3-III-E

Schematic Diagram

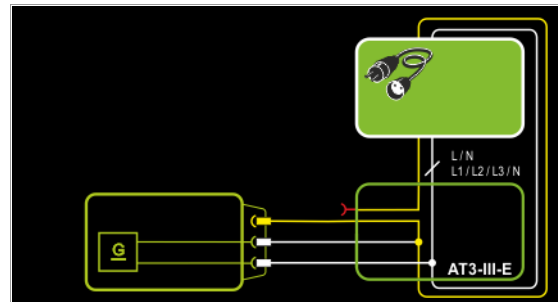

Wiring Diagram

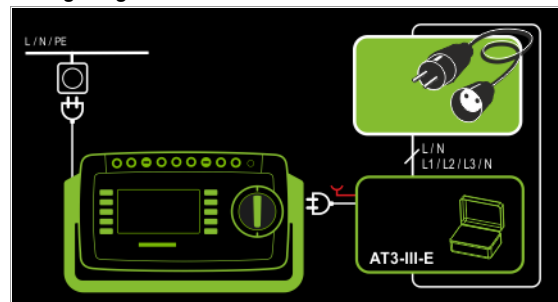

Setting Measuring Parameters



Measuring Parameter	Meaning
Connection Type	
EL1 adapter	Measurement with EL1 adapter and DUT at test socket for single-phase extension cords
AT3-IIIIE adapter	Measurement with AT3-IIIIE adapter for single and 3-phase extension cords
VL2E adapter	Measurement with VL2E adapter for single and 3-phase extension cords

See corresponding single measurements for the testing of RPE and RISO.



Note

See section 10, "Test Sequences in Accordance with Standards" (switch setting A8) with regard to testing extension cords per DIN VDE 0701-0702, for which RPE and RISO are measured.



Attention!

If the EL1 continuity test is conducted for an extension cord in combination with a "travel adapter", results provided by the test instrument indicating the correctness of the extension cord's polarity cannot be relied upon!



Note







In conductors with control lamp (usually glow lamp in the switch), the result of the continuity test for L and N may be distorted by the additional resistance of the glow lamp.

In case of doubt, we recommend performing a continuity test for L and N by means of resistance measurement (R-PE or R-ISO):



SECUTEST PRO: R-PE between probe 1 and probe 2.

SECUTEST BASE(10): R-PE between probe 1 and measurement cable at the earth contacts of the test socket (test type PE(PD)-P1).

Test Sequence with EL1 Adapter

- ⇨ Set the rotary switch to the **EL1** position.
- ⇨ Select the **EL1 adapter** connection type directly via the key shown at the right. 
- ⇨ Connect the EL1 adapter to the P1 sockets at the test instrument.
- ⇨ Connect the plug at the end of the extension cord to the test socket.
- ⇨ Connect the coupling socket at the end of the extension cord to the plug at the EL1 adapter.
- ⇨ **Start the test:** press the **START/STOP** key. 
- ⇨ The measured values are displayed. The measured value recording symbol shown at the right appears. Each time this key is pressed, the currently displayed measured value is saved to the buffer. 
- ⇨ **Stop the test:** press the **START/STOP** key. The save symbol appears (floppy disk showing the number of measured values stored to buffer memory) and prompts you to save the measured values to an ID number. 

- ⇨ Press the **ESC** key in order to discard the measured values stored to buffer memory and acknowledge by pressing the key shown at the right. 



Test Sequence with VL2E Adapter

- ⇨ Set the rotary switch to the **EL1** position.
- ⇨ Select the **VL2E adapter** connection type directly via the key shown at the right. 
- ⇨ Connect the cable from the VL2E adapter to the test socket at the SECUTEST....
- ⇨ Connect the extension cord's plug and socket to the VL2E adapter.
- ⇨ **Start the test:** press the **START/STOP** key. 
- ⇨ Set the rotary selector switch on the VL2E adapter to position 2 and retain this position. The measured values are displayed.



Note

The test instrument only indicates whether or not the cable is **OK** or **not OK**. In the case of "not OK", the inspector has to determine whether or not an interruption or a short-circuit is involved on his own by means of further measurements.

- ⇨ **Stop the test:** press the **START/STOP** key. The save symbol appears (floppy disk showing the number of measured values stored to buffer memory) and prompts you to save the measured values to an ID number. 

- ⇨ Press the **ESC** key in order to discard the measured values stored to buffer memory and acknowledge by pressing the key shown at the right. 

Test Sequence with AT3-IIIIE Adapter



Attention!

Please observe the operating instructions for the AT3-IIIIE regarding correct connection of the test adapter and the device under test, as well as peculiarities involved in the test sequence.

9 Special Functions – EXTRA

Depending on the device configuration, either the QR code for the Internet link to the operating instructions or the measuring view for the temperature measurement is displayed.

SECUTEST BASE(10)

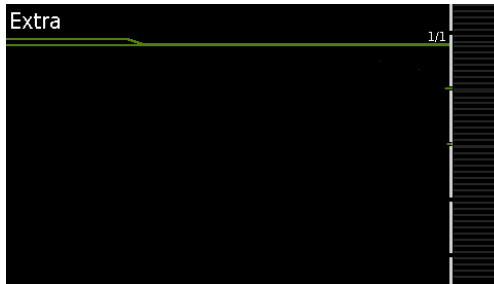

Measurement with Temperature Sensor

Schematic Diagram

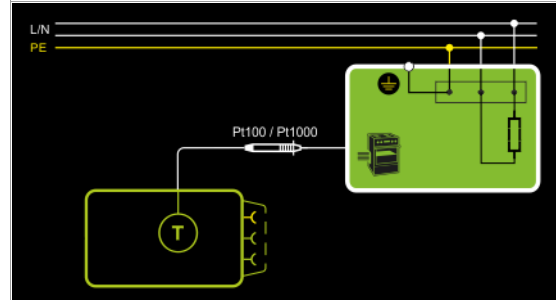

Wiring Diagram

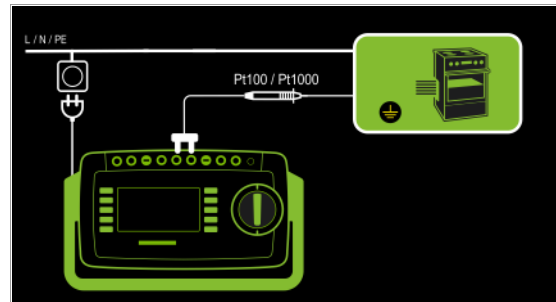

Single measurements, rotary switch level: green



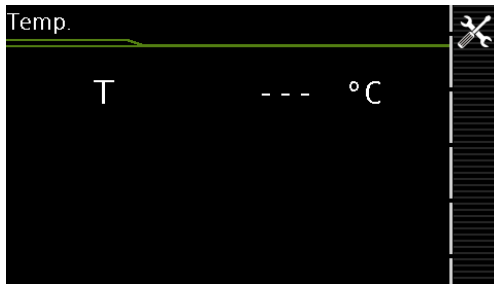

Switch Position	Measuring Functions	Measurement Type,
EXTRA	None	None

QR code: Scanning the QR code allows you to download and read the current operating instructions from www.gossenmetrawatt.com, for example at a tablet PC.

SECUTEST PRO (feature I01)



Test Sequence with Temperature Sensor

- Set the rotary switch to the **EXTRA** position.
- Connect the temperature sensor's plug to the V-COM sockets at the test instrument.
- Contact the device under test.
- **Start the test:** press the **START/STOP** key. 
- The measured values are displayed. The measured value recording symbol shown at the right appears. Each time this key is pressed, the currently displayed measured value is saved to the buffer. 
- **Stop the test:** press the **START/STOP** key. The save symbol appears (floppy disk showing the number of measured values stored to buffer memory) and prompts you to save the measured values to an ID number. 
- Press the **ESC** key in order to discard the measured values stored to buffer memory and acknowledge by pressing the key shown at the right. 

Single measurements, rotary switch level: green

Switch Position	Measuring Functions	Measurement Type,
EXTRA	Temperature	V-COM

In this case, the temperature measurement is assigned to the rotary switch's EXTRA position.

Temperature measurement functions with either a Pt100 or a Pt1000 temperature sensor – the sensor type is automatically detected internally.

10 Test Sequences

Status Upon Shipment (default settings)

Automated test sequences, rotary switch level: orange						
Switch Setting	Standard/ Test sequence	Measurement Type	Connection	Type	Protection class	Freely Configurable Sequence depending on the selected configuration (protection class, type of application part)
Preconfigured (freely adjustable) test sequences						
A1	VDE 0701-0702	Passive	Test socket		auto	Short-circuit test* – visual inspection* – RPE* – RISO* – IPE alt. – function test*
A2	VDE 0701-0702	Active	auto		auto	Short-circuit test* – visual inspection* – RPE* – RISO* – IPE LN – IPE NL – function test*
A3	VDE 0701-0702-IT	Active	auto		auto	Short-circuit test* – visual inspection* – RPE* – IPE LN – IPE NL – function test*
A4	IEC 62353 (VDE 0751)	Passive	Test socket	BF	auto	Short-circuit test* – visual inspection* – RPE* – RISO SKI* – RISO SKII+app. part* – RISO BF* – IGA SKI – IA BF– function*
A5	IEC 62353 (VDE 0751)	Active	auto	BF	auto	Short-circuit test* – visual inspection* – RPE* – RISO SKI* – RISO SKII+app. part* – RISO BF* – IGA SKI – IA BF– function*
A6	per IEC 60974-4	Active	auto		auto	Short-circuit test* – visual inspection* – RPE* – RISO SKI – RISO welding circuit – RISO welding circuit.-PE – IB W1 LN – IB W2 LN – IPE NL – IB W1 NL – IB W2 NL – U(0)/U(R) – function test* – visual inspection*
A7	per IEC 60974-4	Active	AT16/32-DI adap.		SKI	Visual inspection* – RPE* – RISO SKI – RISO welding – RISO welding circuit-PE – IPE NL – IB W1 NL – IB W2 NL – U(0) – visual*
A8	VDE 0701-0702-ExtC	VLTG	EL1		SKI	Short-circuit test* – visual inspection* – RPE* – RISO* – continuity (EL1)
AUTO	VDE 0701-0702	auto	auto		auto	

* Assuming the respective sequence parameter is preset to “on”

auto = automatic detection, see page 53

10.1 General

If the same sequence of single tests will be run frequently (one after the other with subsequent report generation), for example as specified in the standards, it's advisable to make use of test sequences (also called measuring sequences).

Limit values have been entered for test sequences in accordance with the standards. And thus a go/no-go evaluation takes place during measurement based on worst-case assessment. If the momentary measured value is displayed in green, it lies within the limit values specified in the standard. If the measured value is red, it does not fulfill the requirements set forth in the standard. If the measured value is orange, further entries are required after the test step (e.g. cable length), which are decisive as to whether or not the test has been passed. Even if the DUT fails just one single measurement, the test sequence is aborted and testing in accordance with the selected standard is failed.

Automatic test sequences are run in rotary switch positions AUTO, as well as A1 through A8.

Test sequences A1 to A8 and AUTO are preconfigured at the factory.

We recommend assigning frequently used test sequences to A1 through A8, and conducting special sequences for which parameters often need to be adjusted in the AUTO switch position.

The measurements are evaluated automatically by the test instrument. Evaluation is based on the worst-case and, depending on settings, in consideration of measuring uncertainty.

Specifications for the test sequences can be entered to the test instrument in two different ways:

- **SETUP switch position:** general settings can be entered which apply to all test sequences (regardless of the respectively selected standard).
- **Switch positions AUTO and A1 through A8:** classification and sequence parameters can be entered which only apply to the selected switch position.

Test Sequences in the AUTO Switch Position

The following test sequences are included as a standard feature with the **SECUTEST BASE(10)** in the **AUTO, A1 to A8** switch positions:

- **DIN VDE 0701-0702**
Recurrent test and test after repair and modification of electrical equipment
- **IEC 62353**
Medical electrical equipment – Recurrent test and test after repair of medical electrical equipment (applied parts with test probe P1)
- **IEC 60974-4**
Arc welding equipment – Part 4: Periodic inspection and testing (voltage measurement with test probe P1 without electrical isolation). One pole of the voltage to be measured must be connected to PE at the mains.

The individual sequences are selected with the softkeys.

Test Sequences in Switch Positions AUTO, A1 to A8

Up to 8 customer-specific test sequences can be assigned to these rotary switch positions. The sequences are created at the PC with the help of **Sequence Designer** software. The measurements and parameters available in your SECUTEST version are loaded from the test instrument and provided in the PC software for this purpose. Finally, the created test sequence can be loaded directly into the SECUTEST... (prerequisite: database extension Z853R or feature KB01) and saved to the computer as an XML file. As a rule, customer-specific (user-defined) test sequences are identified with a prefixed asterisk on the SECUTEST user interface.

Sequence Designer

With the help of **Sequence Designer** software, test sequences can be created at the PC and transferred to the test instrument via a USB connection or a USB flash drive.



Attention!

If you change or shorten the default test sequences for the respective standards, the danger exists that they will no longer be compliant and will thus become invalid as substantiation of operating safety in accordance with DGUV regulation 3 or BetrSichV, or will no longer fulfill these standards.

General Settings (Setup: auto measurements parameter)

The following settings can be entered for all test sequences in the **SETUP** switch position on menu page 1/3 under the **auto measurements** parameter:

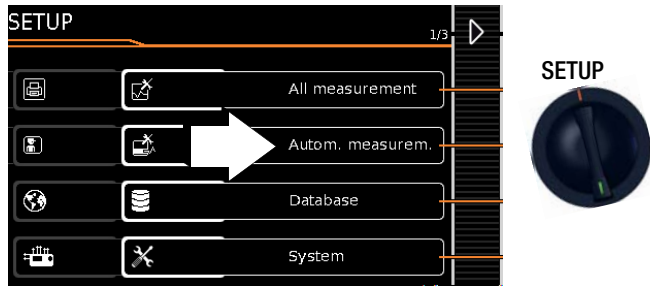

❑ At the End of the Sequence

At the end of a sequence, either the save symbol appears in order to prompt storage (“memory screen” parameter), or the results list (“results list” parameter) is displayed.

❑ Considering Measuring Uncertainty

If **Yes** is selected, measuring uncertainty is taken into consideration when the measurement results are displayed. The final result which appears at the display is downgraded by an amount equal to measuring uncertainty.

❑ Auto Measuring Point

If **Yes** is selected, the test instrument detects whether or not the protective conductor is contacted with the probe during the protective conductor resistance measurement included in an automated test sequence and automatically starts recording a new measuring point. Statuses are indicated by various, continuous acoustic signals. The protective conductor test can thus be conducted without using the keys on the instrument.

👉 Note

The “Auto Measuring Point” function is only activated during test steps of the “multiple measurement” type. If you want to use this function ...

- In the case of integrated test sequences: Make sure that the “multiple measurement” test parameter (see page 54) is selected for the RPE test step.
- In the case of user-defined test sequences (only with Z853R database expansion or feature KB01): Make sure that the RPE test step has been entered to the sequence as a “multiple measurement”.

❑ Initial Window Style

Selection can be made here between a tree view and a detail view for the first page of the test sequence (see section 10.2).

❑ Limit Value Mode

If you want to use only the limit values specified in the standards to evaluate the measurements, set the parameter to **Normal**.

When set to **Expert**, the **LIMIT** softkey appears next to the “measurement failed” popup if the measurement has not been passed. This key makes it possible to enter a user-defined limit value (as a rule a limit value specified by the manufacturer which deviates from the standard), in order to allow the test to be passed under these new conditions.

❑ Measuring sequences (no longer included in menu „Culture“ as from firmware V1.6.0)

The following standards can be selected in this context: VDE, OVE (Dutch version: NEN)

A restart of the instrument is launched provided the setting for „Measuring sequences“ has been modified and menu „Auto Measurements“ is aborted.

👉 Note

The test instrument must be restarted after changing the measuring sequences. Database structure and content remain unchanged.

Meaning of Symbols in the User Interface – Test Sequence

Symbol	Softkey Variants, Test Sequence
	Test for Protection Class I Devices Exposed, conductive parts are connected to the protective conductor so that they are not charged with voltage if the basic insulation should fail.
	Test for Protection Class II Devices These devices are equipped with double insulation or reinforced insulation.
	Test for Protection Class III Devices These devices are supplied with safety extra-low voltage (SELV). Beyond this, no voltages are generated which exceed SELV.
	Type B applied parts (body)
	Type BF applied parts (body float)
	Type CF applied parts (cardiac float)
	Configure sequence parameters (see page 55)
	Set classification parameters
	Assess visual inspection or function test with OK ✓ or not OK ✗ (toggle key)
	Enter a comment, e.g. for the visual inspection or function test
	Continue test, next test step in the test sequence
	Stop continuous measurement , next test in test sequence
	Accept changed parameter, return to memory view
	Stop test sequence
	– Repeat inspection (if it has been failed). – Repeat test step
	– Skip inspection test step – Skip individual tests within the test sequence
	Start evaluation – record measured value. Each time this softkey is pressed, an additional measured value is saved and the number is increased by one.
	Start evaluation sequence during a continuous measurement . The number blinks.
	Record measured value during the evaluation sequence of a continuous measurement .
	Repeat measured value recording
	Delete measured value
	Display measured values
	Display details from the results list
	Hide details from the results list
	The ID number to which the measurement(s) will be stored can be entered here.
	Valid measured values have been obtained for a test sequence. This measurement can be saved.
	Save measurement data as (with display of directory path / ID or new entry of an ID other than the preselected one)

Sample: Initial Page of a Test Sequence – Tree View

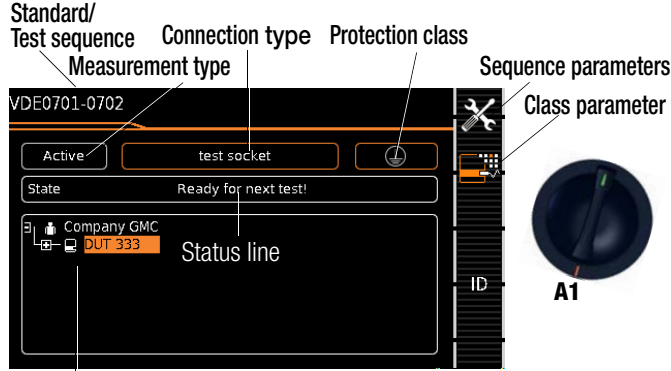

Tree view*

Sample: Initial Page of a Test Sequence – Detail View and Applied Part

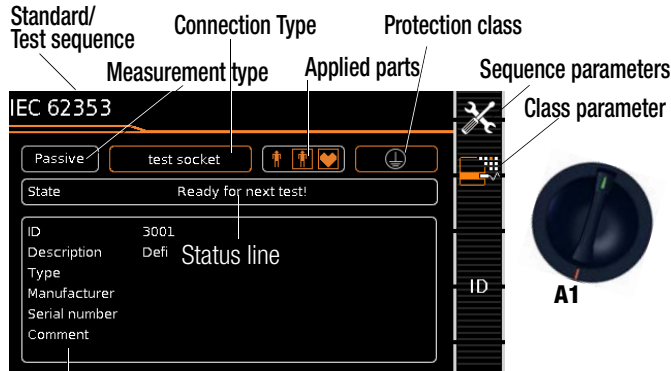

Detail view*

* SETUP switch position:
Setup menu 1/3 > Auto. Measurements > 2/2 > Initial Window Style:
Tree or **Detail View**

Classification Parameter – Automatic Detection

If the settings for certain classification parameters are automatically detected by the test instrument, this is indicated respectively by an orange frame (as of firmware V1.3.0; here: test socket connection type and protection class I). Descriptions of these parameters are listed in the following tables relative to the respective switch positions.



Automatic recognition for safety class active

When connecting or disconnecting a DUT, the safety class may be changed without request for confirmation where necessary.



Automatic recognition for safety class active

The test instrument retains the selected safety class setting when a DUT is connected or disconnected.

Classification Parameter – VDE 0701-0702



Parameter	Setting Options / Meaning
1/2	
Standard/Test Sequence	VDE 0701-0702 VDE 0701-0702-IT, see following table VDE 0701-0702-ExtC, see table below VDE 0701-0702-PRCD, see table below IEC 62353, see table below IEC 60974-4, see table below
Protection class ^{1 2}	Class I, Class II, Class I+II, Class I+III, Class II+III, Class I+II+III
Connection ^{1 2}	test socket Perman. connect. Adapter: AT16/32-DI-Adap. Adapter: VL2E-Adapter Adapter: AT3-Adapter (feature I01) Perman. Con.: P1+P2 (only with feature H01)
2/2	
Meas. Mode ¹⁾	passive active
Auto detection	Conn. & PC & MM Conn. & PC Conn. & MM Conn. only PC & MM Prot. Class only Meas. mode only disabled: all classification parameters such as connection and protection class must be entered manually.

¹ These parameters must be entered manually if they're not automatically detected, or if they're detected incorrectly.

² A limit value of the protective conductor resistance is determined on the basis of length and cross-section. Data remain in memory until a new entry is made.

Classification Parameter – VDE 0701-0702-IT



Parameter	Setting Options / Meaning
1/2	
Standard/Test Sequence	VDE 0701-0702, see table above VDE 0701-0702-IT VDE 0701-0702-ExtC, see table below VDE 0701-0702-PRCD, see table below IEC 62353, see table below IEC 60974-4, see table below
Protection class ^{1 2}	Class I, Class II, Class I+II, Class I+III, Class II+III, Class I+II+III
Connection ^{1 2}	test socket Perman. connect. Adapter: AT16/32-DI-Adap. Adapter: AT3-Adapter (feature I01)
2/2	
Meas. Mode ¹⁾	active
Auto detection	Conn. & PC & MM Conn. & PC Conn. & MM Conn. only PC & MM Prot. Class only Meas. mode only disabled: all classification parameters such as connection and protection class must be entered manually.

¹ These parameters must be entered manually if they're not automatically detected, or if they're detected incorrectly.

² A limit value of the protective conductor resistance is determined on the basis of length and cross-section. Data remain in memory until a new entry is made.



Parameter	Setting Options / Meaning
1/2	
Standard/Test Sequence	VDE 0701-0702, see table above VDE 0701-0702-IT, see previous table VDE 0701-0702-ExtC VDE 0701-0702-PRCD, see following table IEC 62353, see table below IEC 60974-4, see table below
Protection class ^{1 2}	Class I
Connection ^{1 2}	test socket Adapter: AT3-III-E-Adapter Adapter: EL1-Adapter Adapter: VL2E-Adapter
2/2	
Meas. Mode ¹	ExtCord ²
Auto detection	Conn. & PC & MM Conn. & PC Conn. & MM Conn. only PC & MM Prot. Class only Meas. mode only disabled: all classification parameters such as connection and protection class must be entered manually.

¹ These parameters must be entered manually if they're not automatically detected, or if they're detected incorrectly.

² A limit value of the protective conductor resistance is determined on the basis of length and cross-section (with EL1 only length). Data remain in memory until a new entry is made.



Parameter	Setting Options / Meaning
1/2	
Standard/Test Sequence	VDE 0701-0702, see table above VDE 0701-0702-IT, see table above VDE 0701-0702-ExtC, see previous table VDE 0701-0702-PRCD ² IEC 62353, see following table IEC 60974-4, see table below
Protection class ^{1 2}	Class I, Class I+II
Connection ^{1 2}	test socket
2/2	
Meas. Mode ¹	PRCD ³
PRCD Typ ³	PRCD (Standard) PRCD (SPE) PRCD-S (SPE) PRCD-K (SPE)
Auto detection	Conn. & PC & MM Conn. & PC Conn. & MM Conn. only PC & MM Prot. Class only Meas. mode only disabled: all classification parameters such as connection and protection class must be entered manually.

¹ These parameters must be entered manually if they're not automatically detected, or if they're detected incorrectly.

² A limit value of the protective conductor resistance is determined on the basis of length and cross-section. Data remain in memory until a new entry is made.

³ New Classification Parameters „PRCD Type“ (as from Firmware V1.7.0)

(are only displayed if parameter „Standard VDE 0701-0702-PRCD“ has been selected):

- **PRCD (Standard):**
For the testing of simple circuit breaker safety adapters in which the protective conductor is permanently connected.
- **PRCD (SPE):**
(SPE = Switched Protective Earth) For the testing of PRCDs, in which the protective conductor is only connected in switched-on condition.
- **PRCD-S (SPE):**
For the testing of circuit breaker safety adapters of type PRCD-S.
- **PRCD-K (SPE):**
For the testing of circuit breaker safety adapters of type PRCD-K.



Note

The standard or standard variant associated with the respective selector switch position conforms to the default setting.
Ax means that the standard variant VDE 0701-0702-PRCD can be selected in each of the preset switch positions.



Note

For more information on the testing of single-phase and 3-phase type S and K PRCDs by simulating faults, please visit our company website under item **PROFITEST PRCD** test adapter.



Note

The testing of PRCDs (test sequences and time to trip) is only possible for DUTs with a nominal voltage of 230 V.



Parameter	Setting Options / Meaning
1/2	
Standard/Test Sequence	VDE 0701-0702, see table above VDE 0701-0702-IT, see table above VDE 0701-0702-ExtC, see table above VDE 0701-0702-PRCD, see previous table IEC 62353 IEC 60974-4, see following table
Protection class ¹	Class I, Class II or Class I+II
Connection type ¹	test socket Perman. connect. Adapter: AT16/32-DI-Adap. Adapter: AT3-Adapter Perman. Con.: P1+P2 (only with feature H01)
2/2	
Measurement type (MA) ¹	passive active
Applied parts	Applied parts: none, B, BF, CF or combinations Type B (body): Devices of this type are suitable for both internal and external patient applications, except for use in direct proximity to the heart. The following protection classes are permissible: I, II, III or devices with internal electrical power supply. Type BF (body float): same as type B, but with type F insulated applied parts. Type CF (cardiac float): Devices of this type are suitable for use directly at the heart. The applied part may not be grounded. The following protection classes are permissible: I, II or devices with internal electrical power supply.
Auto detection	Conn. & PC & MM Conn. & PC Conn. & MM Conn. only PC & MM Prot. Class only Meas. mode only disabled: all classification parameters such as connection and protection class must be entered manually.

¹ These parameters must be entered manually if they're not automatically detected, or if they're detected incorrectly.



Parameter	Setting Options / Meaning
1/2	
Standard/Test Sequence	VDE 0701-0702, see table above VDE 0701-0702-IT, see table above VDE 0701-0702-ExtC, see table above VDE 0701-0702-PRCD, see table above IEC 62353, see previous table IEC 60974-4
Protection class ¹	Class I, Class II or Class I+II
Connection type ¹	test socket Perman. connect. Adapter: AT16/32-DI-Adap. Adapter: AT3-Adapter
2/2	
Measurement type (MA) ¹	Active
Voltage, rating plate	Voltage from rating plate U(R) RMS (Limit value RMS, variably adjustable) or open-circuit voltage U0 DC (limit value = 113 V DC)
Auto detection	Conn. & PC & MM Conn. & PC Conn. & MM Conn. only PC & MM Prot. Class only Meas. mode only disabled: all classification parameters such as connection and protection class must be entered manually.

¹ These parameters must be entered manually if they're not automatically detected, or if they're detected incorrectly.

Sequence Parameter (as of firmware V1.3.0)



The default test sequences can be adapted to your application or test standard via the sequence parameter. The entered sequence parameter settings are only valid for the currently selected switch position (A1 to A8 or AUTO) and are retained until they are changed. Not all of the parameters are relevant, depending on the selected DUT classification (protection class etc.).

❑ Suppressing Test Steps

Depending on the selected test standard, some of the following test steps can be suppressed:

Parameter	Suppressible test steps
Visual Inspection	Visual Inspection
Function test	Function test
RPE	Protective conductor resistance test
RISO PCI+II	Insulation resistance tests for PCI and PCII
RISO pri./sec.	Insulation resistance test between the primary and secondary sides of PCIII DUTs
RISO sec./PE	Insulation resistance test between the secondary side and PE of PCIII DUTs
RISO BF/CF (IEC 62353)	Insulation resistance tests at BF/CF application parts
RISO welding circuit (IEC 60974-4)	RISO tests between the primary side and the welding output, as well as between PE and the welding output
Reversed polarity	All leakage current measurements with reversed polarity
IPE measurement type (active)	Protective conductor current test
IB	Touch current test
IB welding circuit	Touch current test at welding circuit
Display test instructions	Test instructions which are not necessarily required for experienced inspectors
Short-circuit test L-N	Short-circuit test between L and N ¹
Short-circuit test LN-PE	Short-circuit test between LN and PE1 ¹
Open-circuit voltage (IEC 60974-4)	Open-circuit voltage at welding unit
Continuity test (VLTG test only)	Continuity test with EL1/VL2E/AT3-III adapter
PCIII supply voltage	Supply voltage measurement (for PCIII DUTs; only for measurement type „Active“)

¹ Before switching line voltage to the device under test, a short-circuit test is conducted regardless of this setting.

❑ Setting Measuring Parameters for Individual Test Steps

Depending on the selected test standard, some of the following test steps can be selected:

Parameter	Meaning
RPE IP	Select test current for protective conductor resistance test: 200 mA AC, ±200 mA DC or 10 A AC (only with SECUTEST BASE10/PRO or feature G01)
IPE measurement type (active)	Select measurement type for protective conductor current measurement for active device testing (differential/direct)
IG measurement type (active) (IEC 62353)	Select measurement type for device leakage current measurement for active device testing (differential/direct)

❑ Select between single and multiple measurement for individual test steps

Parameter (as of FW 1.5.0)	Meaning
RPE as	Switch the “protective conductor resistance” test step back and forth between multiple and single measurement

Parameter (as of FW1.8.0)	Meaning
RISO SK II as	Switch the insulation resistance measurement at PC II parts (measurements at applied parts/welding outputs are not affected) back and forth between multiple and single measurement
IB as	Switch the touch current measurement back and forth between multiple and single measurement
IB SK II as	(IEC 60974 only) Switch the touch current measurement at PC II parts back and forth between multiple and single measurement

❑ Set measurement duration of individual test steps (as of firmware 1.5.0)

Testing time for the respective measurement can be influenced with these parameters. If a test step for a single measurement is involved, the entire test step has a duration of the time entered in seconds. If a test step for a multiple measurement is involved, the measurement duration for each measuring point is influenced.

If 0 seconds is selected, continuous measurement is conducted which can only be ended by pressing a key.

Parameter (as of FW 1.5.0)	Meaning
RPE measurement duration ¹	Set testing time for the protective conductor resistance measurement (0 to 60 seconds)
IPE measurement duration	Set testing time for the protective conductor current measurement (0 to 60 seconds)
IG measurement duration	Set testing time for the device leakage current measurement (0 to 60 seconds)

¹ For measuring sequence VDE 0701-0702-PRCD with the following setting „PRCD type: PRCD (SPE)“ the measurement duration **cannot** be influenced.

The measurement duration which has been set in this case only affects the RPE measurement with PRCD types „PRCD (standard)“ and „PRCD-S (SPE)“.

Parameter (as of FW1.8.0)	Meaning
IB measurement duration	Set testing time for the touch current measurement (0 to 60 seconds)
IB SK II measurement duration	(only for IEC 60974) Set testing time for the touch current measurement at PC II parts (with the exception of welding outputs) (0 to 60 seconds)
RISO SK II measurement duration	Set testing time for RISO measurements at PC II parts (0 to 60 seconds)

10.3 Connecting the DUT

- ◇ Connect the DUT to the test instrument in accordance with the selected test sequence.
 - Test socket
 - Permanent connection
 - Adapter

Application note for AT-IIIIE test adapter:

Please note that the pole reversal function is not active with the applied test instrument if you use the AT3-IIIIE adapter for the testing of single-phase test objects (socket 3 / earthing contact plug). In this case, all leakage current measurements must be performed manually in **both** pole directions.

Switch position: A1 ... A7, AUTO



Connection depends on the type of DUT (see the respective connection type in the classification parameters tables).

Switch position A8

For testing extension cords in accordance with standards: connection to the test socket via the following adapter:

- **EL1:** for single-phase extension cords
- **VL2E:** for single and 3-phase extension cords

10.4 Selecting a DUT

- ◇ If no DUT has been selected in the initial display, enter its ID number, for example by means of a barcode scanner, after selecting **ID**.
- ◇ As an alternative, activate the database view with the **MEM** key: 
- ◇ Select the DUT for the test sequence with the scroll keys. 
- ◇ Return to the measuring view by pressing the **MEM** key. 

10.5 Checking Connection and Starting the Test Sequence

- ◇ Trigger the connection test and the test sequence by pressing the **START** key. 

The following checks are run automatically before the test sequence is started:

- Probe test (whether or not test probe P1 is connected)
- Insulation test (whether or not the DUT is set up in a well-insulated fashion)
- On test and short-circuit test (prerequisite: "short-circuit test L-N" sequence parameter is preset to "on".
In order to be able to detect a short-circuit at the DUT, testing is conducted between L and N, as well as LN and PE.

Note

If you deselect important test steps under sequence parameter (set to off), the test sequence might not fulfill the requirements stipulated by the standard any more.

If you have set the "**Detected classification**" parameter for the respective test sequence to "Always accept" and the "**Auto-detection of**" parameter to "Connection and PC" (before triggering **Start**), the following additional checks will be run before the test sequence is started: 

- Protection class detection for DUTs with protective conductor *
- Connection check *: check whether or not the DUT is connected to the test socket. In the case of protection class I: whether or not the two protective conductor terminals are short-circuited.



* applies to **M7050** with feature B00, B09 and B10

10.6 Executing and Evaluating Test Steps

Manual Evaluation of Visual Inspection

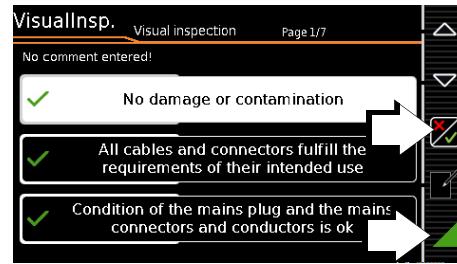
(prerequisite: "visual inspection" sequence parameter is preset to "on".





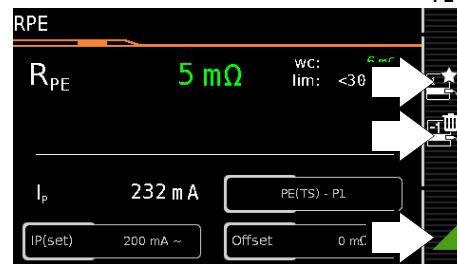

- ◇ Evaluate the visual inspection. 
- ◇ If you mark even one visual inspection as not passed with the key shown at the right, the sequence is aborted and the test is evaluated as not passed. 
- ◇ Resume the test sequence. 

Test Steps with Manual Evaluation (e.g. R_{PE})



- ◇ Observe instructions which appear at the display, e.g. prompting instructions to contact parts with test probe P1.

If the measured value appears green at the display, it lies within the limits specified by the standard.

- ◇ The measured value recording symbol appears in the softkey bar. The 0 indicates that no measured values have thus far been saved to buffer memory. 
- ◇ Each time this key is pressed, the measuring or evaluation procedure is restarted. 
- ◇ Initially, the digit blinks (here a 1 without symbol) until the measured value settles in. The evaluation cycle is visualized as follows: the progress bar starts at the left-hand edge of the display and moves to the right. When it reaches the rightmost position, evaluation has been completed and the symbol shown at the right appears with the current number. 
- ◇ Depending on whether you want to delete the last value saved to the clipboard or all values, press the symbol with the wastebasket shown at the right an appropriate number of times. 
- ◇ Proceed to the next measurement by pressing the key shown at the right. 

Note

If the measured value appears red at the display, a limit value has been violated. If you nevertheless start the evaluation procedure, an error message appears. You have the option of repeating the evaluation procedure. 

Note

Regarding the test sequence in switch position A6/A7: Section 5.2 of DIN EN 90974-4 expressly stipulates that the cables have to be bent and twisted over their entire length during the measurement, in particular in proximity to the cable glands, in order to be able to detect any interruptions of the protective conductor.

Test Steps with Automatic Evaluation (R_{ISO}, I_{PE})

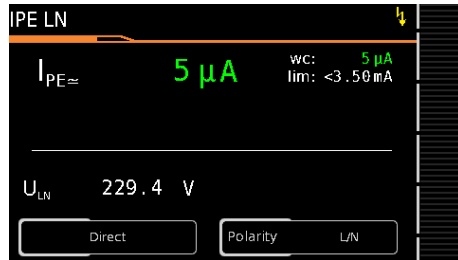

The measured value is ascertained automatically within a specified period of time. The evaluation cycle is visualized as follows: the progress bar starts at the left-hand edge of the display and moves to the right. When it reaches the rightmost position, evaluation has been completed. The test sequence is then automatically resumed.

Manual Evaluation of the Function Test

(prerequisite: “function test” sequence parameter is preset to “on”).

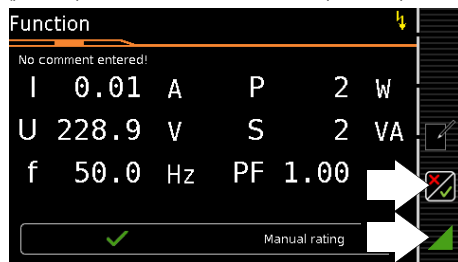

- Evaluate the function test:
- If you mark the function test as not passed with the softkey shown at the right, the sequence is aborted and the test is evaluated as not passed.
- If you evaluate the function test as passed, you can simply continue with the test sequence.

In either case you can enter a comment, which can be subsequently edited as well.

10.7 Setting Limit Values Manually

If “Expert” is selected instead of “Normal” in setup under “Auto Measurements” in the “Limit Value Mode” submenu, the LIMIT softkey appears next to the “measurement failed” popup. This key makes it possible to enter a user-defined limit value (as a rule a limit value specified by the manufacturer which deviates from the standard):

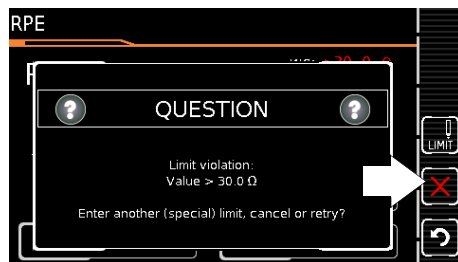

10.8 Ending the Test Sequence

“Sequence finished” appears at the display.

Initial Display (memory screen)

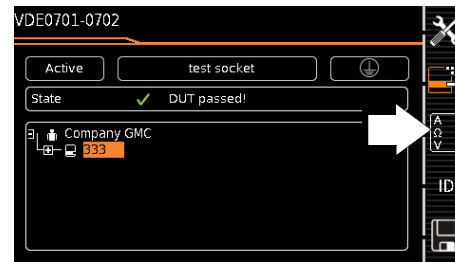

Display of the memory screen depends on the setting in the setup menu in the **SETUP** switch position: Setup 1/3 > Auto. measurements > At end of sequence > **Memory screen**.

If set to **Results list**, the above display is skipped and the results list shown below is displayed.

You can also access the results list by pressing the key shown at the right.

Results List Display



- Select the desired test step with the scroll keys.

- If you want to view details for the selected test step, press the **magnifying glass+** key.

Consideration of measuring error depends on the setting in the setup menu in the **SETUP** switch setting: Setup 1/3 > Auto. measurements > Error considered. > **Yes**

Display of Details for Individual Test Steps

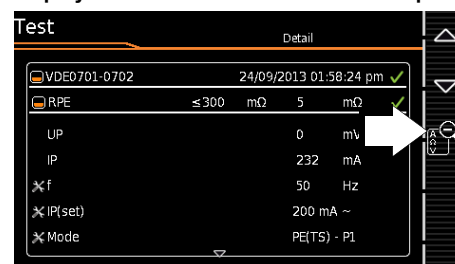

- The display is returned to the list of test steps by pressing the **magnifying glass-** key.

- The memory screen is displayed again after acknowledging the list.

10.9 Saving Test Results

- Save the results of a successful test sequence by pressing the **Save** key.

11 Warnings, Error Messages and Notes

Error messages or notes regarding the individual tests or test sequences are displayed as popups.

Differentiation is made amongst 5 types of messages:

- Fatal error
- Error
- Warning
- Note – INFO
- Question

Fatal error

This message indicates an extraordinary error. Fatal errors have to be acknowledged or cleared by pressing the **OK** key, and the cause of error must be eliminated before the test or the test sequence can be resumed.



Error

This message indicates, for example, operator errors. These errors have to be acknowledged or cleared by pressing the **OK** key, and the cause of error must be eliminated before the test or the test sequence can be resumed.

Examples:

- Object cannot be created. General database error!

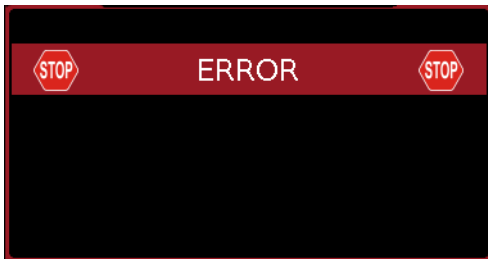

Warning

Warnings indicate hazards which, if not avoided, may result in severe injury. **Single test:** Warnings have to be acknowledged or cleared by pressing the **OK** key, before the test or the test sequence can be resumed.

Test sequence: The test sequence can be aborted or resumed without acknowledging.

Examples:

- Caution: Line voltage will be switched to the test socket!
- Caution: The polarity of line voltage at the test socket will be reversed!



Note – INFO

A note is either a piece of information regarding the functions executed by the test instrument or instructions which may have to be acknowledged or skipped by pressing the **OK** key.

Examples:

- Probe test
- Set up in a well-insulated fashion?
- On test
- Short-circuit test (L-N)
- Short-circuit test (LN-PE)
- Prompt: Contact with test probe P1 ...
- Prompt: Switch the DUT on/off with its own mains switch ...
- Prompt: Start up / shut down the DUT ...





Question

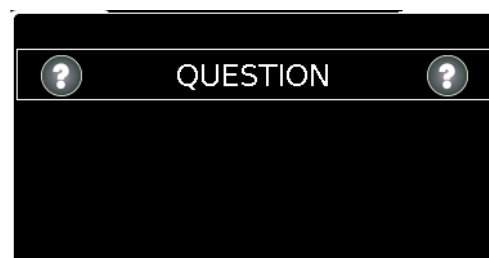

Questions must be answered by pressing **Yes** or **No** before the single test or test sequence is resumed.

Example:

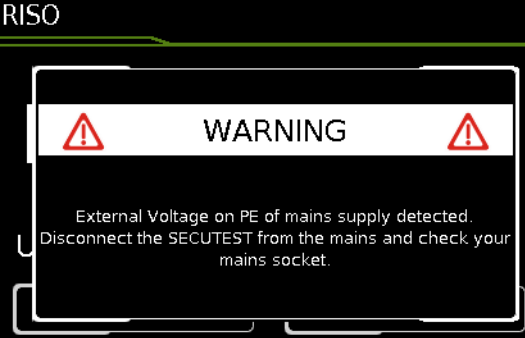
- Test object not found!
Create new object/database?

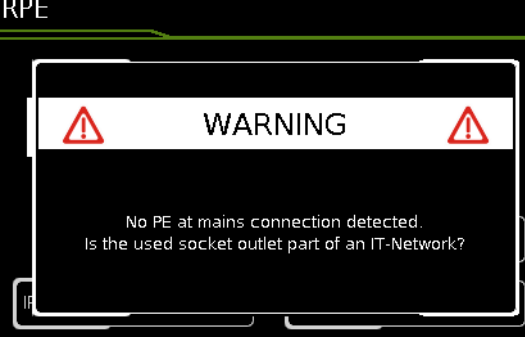
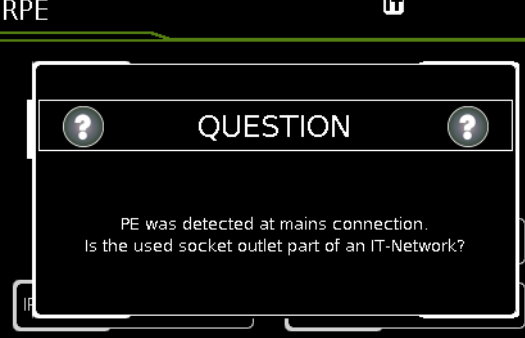
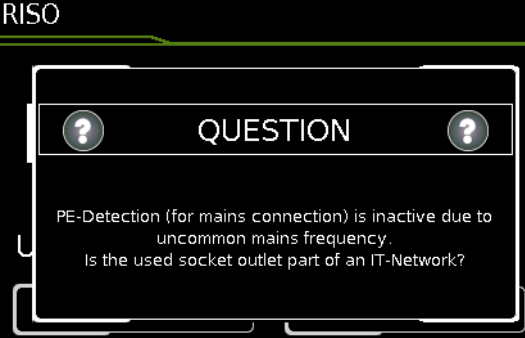

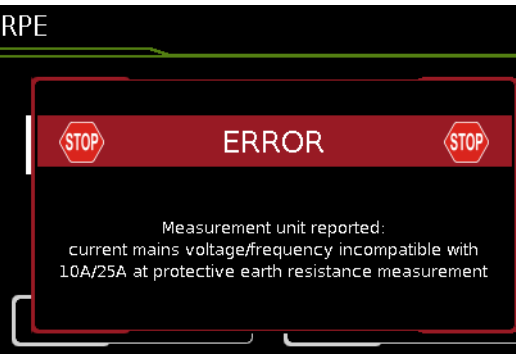
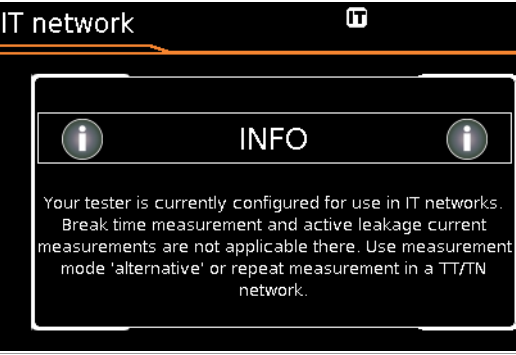
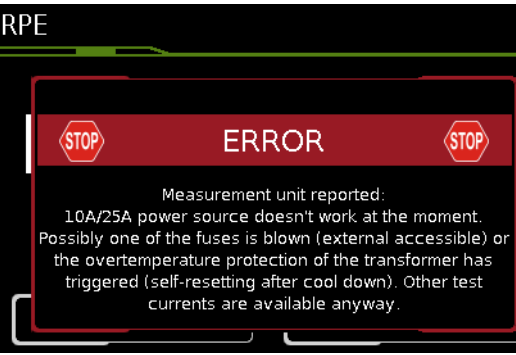
Error Messages	Possible Causes	Corrective Measures
Mains Connection Errors		
<p>RISO</p> 	<ul style="list-style-type: none"> – Protective conductor PE at the mains outlet at which the SECUTEST is being operated is conducting voltage! This detection function makes use of the metallized START/STOP key on the test instrument. In order for detection to function correctly, it must be possible to establish reference to earth potential via the user's finger. <p>Note  If the user's finger is insulated from the key when it's pressed, this error message may occur although the installation is OK (see "Automatic Recognition of Mains Connection Errors" on page 9).</p>	<ul style="list-style-type: none"> ⇨ Please remove the SECUTEST's mains plug from this outlet and arrange to have the outlet/installation inspected by a qualified electrician without delay. Do not operate any other devices at this electrical outlet before this inspection has been completed. ⇨ In order to ensure that detection functions reliably, repeat the interference voltage test and observe the following tips: <ul style="list-style-type: none"> – Unplug all USB devices from the SECUTEST's USB ports. – Remain in contact with a grounded object while pressing the START/STOP key (e.g. a heating pipe). – Do not contact the START/STOP key with an object or while wearing gloves.
<p>RPE</p> 	<p>PE connection not detected (at the outlet at which the test instrument is being operated):</p> <ul style="list-style-type: none"> – If the installation is defective! – In the case of special types of TT systems; detection may fail in this case. – If the test instrument is being operated in an IT system 	<ul style="list-style-type: none"> ⇨ If the test instrument is being operated in an IT system: Acknowledge the question by pressing ✓ – the IT system option is activated in this case. ⇨ If it's not an IT system: remove the mains plug from the outlet and inspect the installation without delay! ⇨ If it's a TT system without neutral conductor, press ✗; direct leakage current measurements are possible. (Make absolutely sure that direct leakage current measurements are possible in your current mains type!)
<p>RPE</p> 	<p>As opposed to the previously used mains connection, PE was detected while the IT system option was activated in setup.</p>	<ul style="list-style-type: none"> ⇨ Operation in an IT system: Respond to the question by pressing ✓. The IT System option remains thus active. ⇨ Operation in an TN or a TT system: Respond to the question by pressing ✗. As a consequence, the IT system option is deactivated.
<p>RISO</p> 	<p>Line frequency is less than 48 or greater than 62 Hz.</p>	<ul style="list-style-type: none"> ⇨ PE detection does not work in this case: select ✓ or ✗, depending on whether or not the utilized system is an IT system.

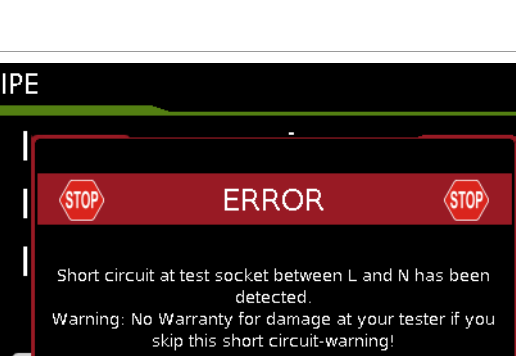
Error Messages	Possible Causes	Corrective Measures
<p>RPE</p> 	<ul style="list-style-type: none"> – Momentary line voltage at the SECUTEST test instrument is outside of the range permitted for a 10 A/25 A-R_{PE} measurement (110 to 120 V or 220 to 240 V). 	<ul style="list-style-type: none"> ⇨ The 10 A/25 A-R_{PE} measurement is only available when line voltage is between 220 V and 240 V or 110 V and 120 V at 50 Hz or 60 Hz. ⇨ If you're working with the SECUTEST in a system which does not lie within this voltage range, use one of the 200 mA test currents in order to determine protective conductor resistance.
<p>IT network</p> 	<ul style="list-style-type: none"> – IT system option (see section 4.1.1 Measurements in IT Systems) is activated. An attempt has been made to launch an active leakage current measurement or a measurement that refers to the PE at the mains connection end (or a test sequence which includes such measurements). 	<ul style="list-style-type: none"> ⇨ Select measurement type "passive" or ⇨ Perform the requested tests in a TT/TN system rather than in an IT system and configure the SECUTEST for that purpose. or ⇨ Deactivate the leakage current measurements in the sequence parameters if possible.
Connection Error at the Test Socket		
<p>RPE</p> 	<ul style="list-style-type: none"> – Test probe P1 is not connected. Or – The test instrument's 10 A/25 A transformer is overheated. Or – One of the fuses has blown (fuse holder in close proximity to the mains input). 	<ul style="list-style-type: none"> ⇨ Repeat measurement with probe P1 connected. ⇨ Check the fuses and replace if necessary. ⇨ Select a different test current (e.g. 200 mA) or wait until the transformer has cooled down and then repeat the measurement. <div style="border: 1px solid black; padding: 5px; margin-top: 10px;">  <p>Attention! The 10 A/25 A measurement is not suitable for continuous operation!</p> </div>
<p>IPE</p> 	<ul style="list-style-type: none"> – A short-circuit has been detected at the test socket between L and N. 	<ul style="list-style-type: none"> ⇨ Determine whether or not the device under test is defective. ⇨ In the case of DUTs which are intended for operation at an outlet that's protected with a 16 A fuse, a short-circuit may be detected under certain circumstances if, for example, they include a PTC resistor (e.g. large floodlights). Be sure to use a 3-phase test adapter in order to test devices of this sort (e.g. the AT3-III E). ⇨ You can skip over this short-circuit message at your own risk and place the device under test into service. Any damage resulting from skipping over this warning is excluded from the guarantee!

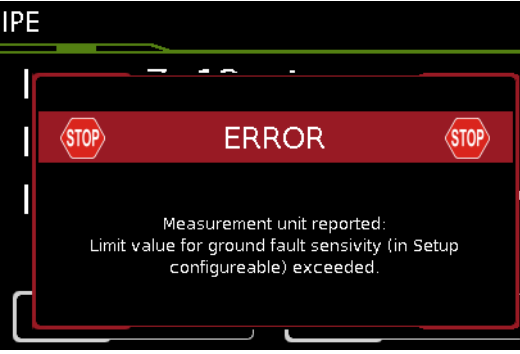
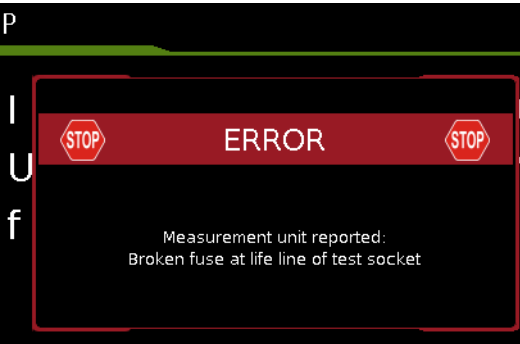
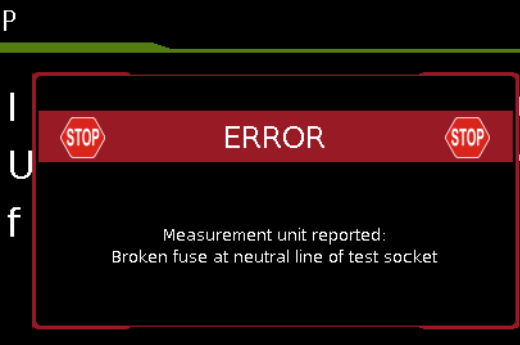
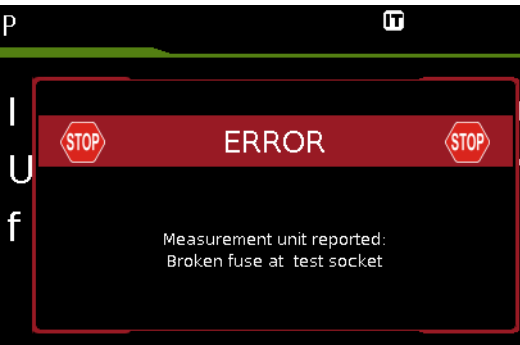
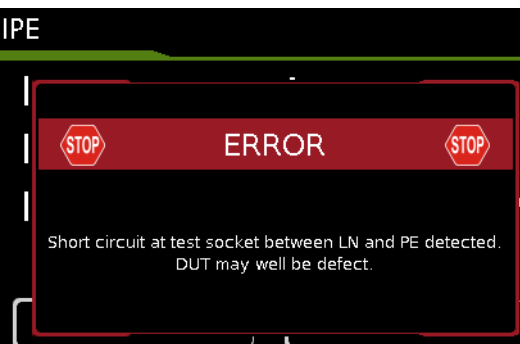
Error Messages	Possible Causes	Corrective Measures
 <p>IPE</p> <p>Measurement unit reported: Limit value for ground fault sensitivity (in Setup configureable) exceeded.</p>	<ul style="list-style-type: none"> - A device under test is connected to the SECUTEST and has been started up, whose leakage current (measured by means of the differential current method) exceeds the limit value specified in setup. 	<ul style="list-style-type: none"> ⇨ If the device under test normally generates a leakage current of greater than 10 mA (e.g. large heaters), temporarily increase the "residual current protection" value selected in setup to 30 mA and try again. ⇨ If values of this magnitude are not to be expected for the respective device under test, or if the "residual current protection" value has already been set to 30 mA in setup, there may be a ground fault at the DUT.
 <p>P</p> <p>Measurement unit reported: Broken fuse at life line of test socket</p>	<ul style="list-style-type: none"> - The fuse for the test socket's L conductor has blown (fuse link 2). 	<ul style="list-style-type: none"> ⇨ Disconnect the test instrument from the mains and inspect the fuses next to the SECUTEST's mains connection.
 <p>P</p> <p>Measurement unit reported: Broken fuse at neutral line of test socket</p>	<ul style="list-style-type: none"> - The fuse for the test socket's N conductor has blown (fuse link 1). 	<ul style="list-style-type: none"> ⇨ Disconnect the test instrument from the mains and inspect the fuses next to the SECUTEST's mains connection.
 <p>P</p> <p>Measurement unit reported: Broken fuse at test socket</p>	<ul style="list-style-type: none"> - One of the two fuses for the test socket has blown (fuse link 1 or 2). 	<ul style="list-style-type: none"> ⇨ Disconnect the test instrument from the mains and inspect the fuses next to the SECUTEST's mains connection.
 <p>IPE</p> <p>Short circuit at test socket between LN and PE detected. DUT may well be defect.</p>	<ul style="list-style-type: none"> - A short-circuit has been detected at the test socket between L/N and PE. 	<ul style="list-style-type: none"> ⇨ Determine whether or not the device under test is defective. Repeat the visual inspection.

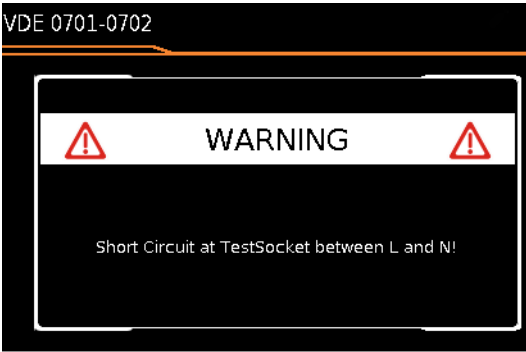
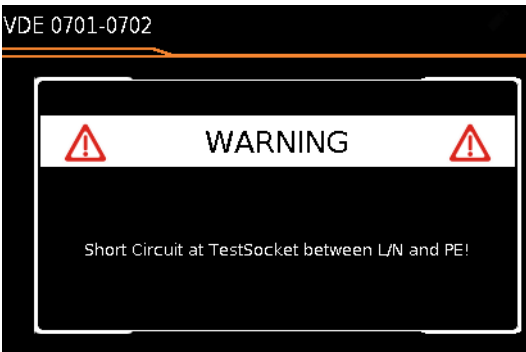
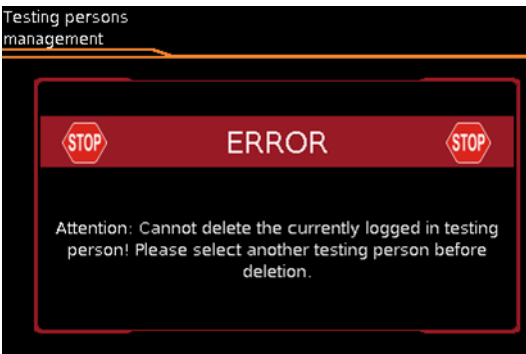
Error Messages	Possible Causes	Corrective Measures
	<ul style="list-style-type: none"> - A short-circuit has been detected at the test socket between L and N. 	<ul style="list-style-type: none"> ⇒ Determine whether or not the device under test is defective. ⇒ In the case of DUTs which are intended for operation at an outlet that's protected with a 16 A fuse, a short-circuit may be detected under certain circumstances if, for example, they include a PTC resistor (e.g. large floodlights). Be sure to use a 3-phase test adapter in order to test devices of this sort (e.g. the AT3-III E). ⇒ You can deactivate this short-circuit test in the sequence parameters at your own risk.
	<ul style="list-style-type: none"> - A short-circuit has been detected at the test socket between L/N and PE. 	<ul style="list-style-type: none"> ⇒ Determine whether or not the device under test is defective. Repeat the visual inspection.
General Parameter Errors		
	<ul style="list-style-type: none"> - The inspector to be deleted is currently selected and thus cannot be deleted! 	<ul style="list-style-type: none"> ⇒ Activate a different inspector before deleting.

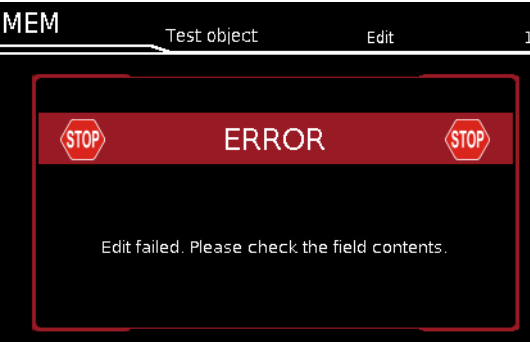
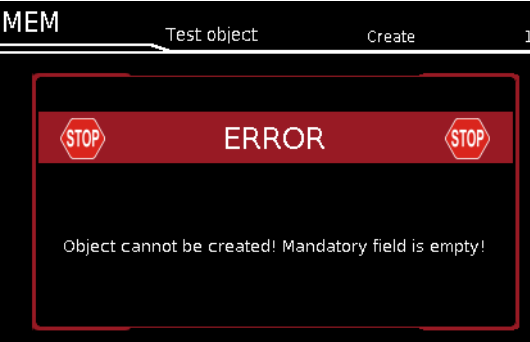
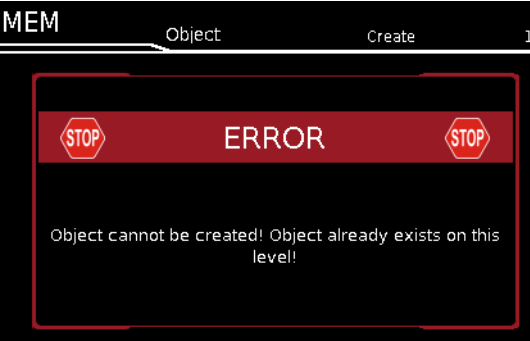
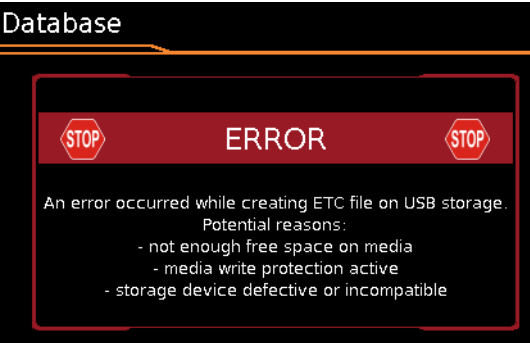
Error Messages	Possible Causes	Corrective Measures
Database Processing Error		
 <p>MEM Test object Edit 1</p> <p>ERROR</p> <p>Edit failed. Please check the field contents.</p>	<ul style="list-style-type: none"> – One of the fields was filled in with invalid content while processing an existing database object. 	<ul style="list-style-type: none"> ⇒ Please be certain to complete all mandatory fields (identified in red). ⇒ If necessary, check your entries to the fields for invalid special characters.
 <p>MEM Test object Create 1</p> <p>ERROR</p> <p>Object cannot be created! Mandatory field is empty!</p>	<ul style="list-style-type: none"> – The ID field was not filled in while creating a new device under test. 	<ul style="list-style-type: none"> ⇒ Fill in the ID field.
 <p>MEM Object Create 1</p> <p>ERROR</p> <p>Object cannot be created! Object already exists on this level!</p>	<ul style="list-style-type: none"> – There's already an object with the same ID under the "Customer" database object. 	<p>An incorrect barcode has been selected.</p> <ul style="list-style-type: none"> ⇒ Assign another ID.
 <p>Database</p> <p>ERROR</p> <p>An error occurred while creating ETC file on USB storage. Potential reasons: - not enough free space on media - media write protection active - storage device defective or incompatible</p>	<p>Error while creating ETC file on USB flash drive</p> <p>There is not or no longer enough free space on storage device left.</p> <ul style="list-style-type: none"> – Particularly in the case of USB flash drives formatted for FAT16: too many files on USB drive – Power consumption of USB flash drive in use exceeds 500 mA. – USB flash drive has been disconnected during the data import process – USB flash drive is defective or incompatible with the SECUTEST. 	<p>Make sure that a minimum storage capacity of 100 MB is available on the USB drive and/or delete any data files no longer required.</p> <ul style="list-style-type: none"> ⇒ If the problem persists, save the data of the USB drive on another storage device and format the USB drive (file system FAT32). ⇒ Only use USB drives with a power consumption of less than 500 mA in combination with the SECUTEST ⇒ Make sure that the USB drive is not disconnected or moved until the data export process is completed. ⇒ If none of these measures leads to an improvement, replace the USB flash drive. A list of tested devices is included in section 14.3.

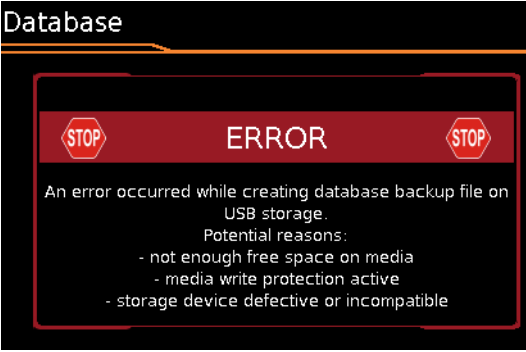
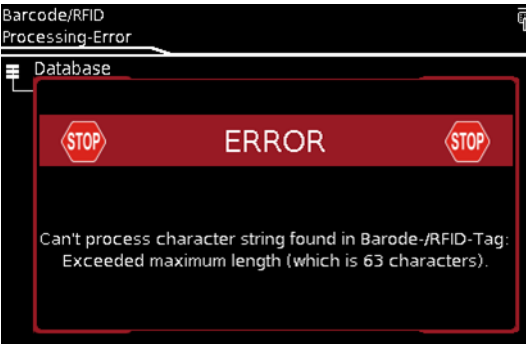
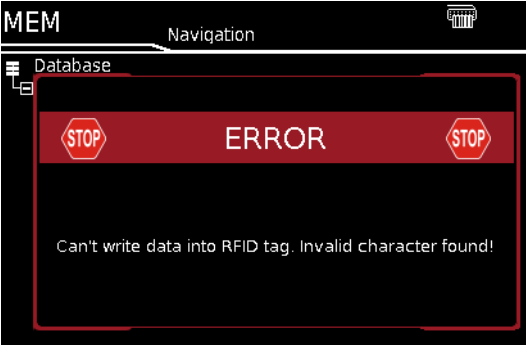
Error Messages	Possible Causes	Corrective Measures
<p>Database</p> 	<p>Error while creating database backup file on USB flash drive</p> <p>There is not or no longer enough free space on storage device left.</p> <ul style="list-style-type: none"> - Particularly in the case of USB flash drives formatted for FAT16: too many files on USB drive - Power consumption of USB flash drive in use exceeds 500 mA. - USB flash drive has been disconnected during the data import process - USB flash drive is defective or incompatible with the SECUTEST. 	<p>Make sure that a minimum storage capacity of 100 MB is available on the USB drive and/or delete any data files no longer required.</p> <ul style="list-style-type: none"> ⇒ If the problem persists, save the data of the USB drive on another storage device and format the USB drive (file system FAT32). ⇒ Only use USB drives with a power consumption of less than 500 mA in combination with the SECUTEST ⇒ Make sure that the USB drive is not disconnected or moved until the data export process is completed. ⇒ If none of these measures leads to an improvement, replace the USB flash drive. A list of tested devices is included in section 14.3.
Errors during Operation with Barcode Scanner or RFID Scanner		
<p>Barcode/RFID Processing-Error</p> 	<ul style="list-style-type: none"> - The scanned barcode is too long. 	
<p>MEM Navigation</p> 	<ul style="list-style-type: none"> - While writing an RFID tag an attempt was made to write an ID to the tag with vowel mutations such as ä, ü or ö, or with special characters. 	<ul style="list-style-type: none"> ⇒ Change vowel mutations such as ä to ae. ⇒ Avoid the use of special characters in the ID.

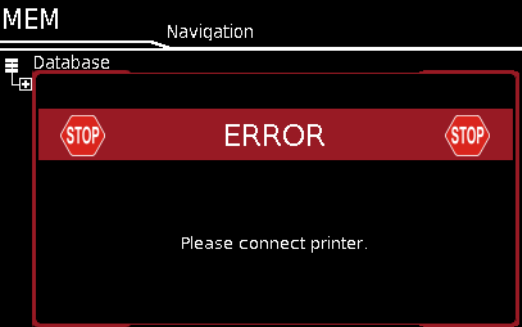
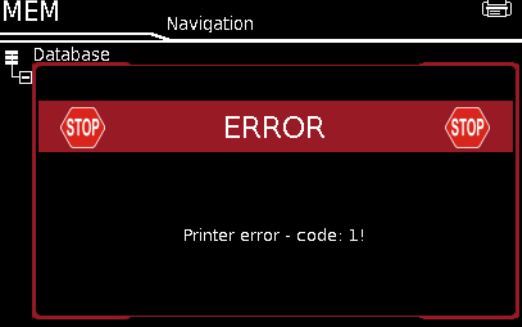
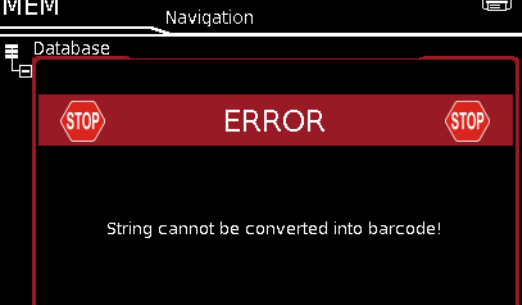
Error Messages	Possible Causes	Corrective Measures
Printer Connection Error		
 <p>MEM Navigation Database</p> <p>ERROR</p> <p>Please connect printer.</p>	<ul style="list-style-type: none"> - The printer is not connected. - An incompatible printer has been connected. 	<ul style="list-style-type: none"> ⇒ Connect the printer to the USB port before pressing the PRINT key. ⇒ Make sure that the utilized printer is listed in section 14.1, "List of Suitable Printers with USB connection".
 <p>MEM Navigation Database</p> <p>ERROR</p> <p>Printer error - code: 1!</p>	<ul style="list-style-type: none"> - No recording chart in the thermal printer. - The printer is defective. 	<ul style="list-style-type: none"> ⇒ Insert a new recording chart.
 <p>MEM Navigation Database</p> <p>ERROR</p> <p>String cannot be converted into barcode!</p>	<ul style="list-style-type: none"> - The test object ID which can be printed as a barcode contains an inadmissible character, such as, for example, mutated vowels or special characters or else fails to conform to the rules which apply to the adjusted barcode coding (e.g. EAN 13: only numeric characters, overall length 13 characters, last character test character only) 	<ul style="list-style-type: none"> ⇒ Select another barcode coding (SETUP => Printer => Z721D => Printer Setting => Coding) ⇒ Change vowel mutations such as ä to ae. ⇒ Avoid the use of special characters in the ID. ⇒ Adapt the ID to the required length of the selected barcode coding.

11.2 List of Possible DUT Connections Depending on Measurement Type

Measurement Type	Suitable for DUT Connection via
RPE	
PE(TS) - P1 passive	Test socket, EL1 test socket, VL2E, AT3-III E, AT3-IIS, AT3-IIS32, AT16DI/AT32DI
PE(TS) - P1 active	Test socket (for PRCDs)
PE(mains) - P1	Permanent connection
PE(mains) - P1 clamp	Permanent connection
P1 - P2	Permanent connection
RINS	
LN(TS) - PE(TS)	Test socket, EL1, VL2E, AT3-III E, AT3-IIS, AT3-IIS32, AT16DI/AT32DI, CEE adapter
LN(TS) - P1	Test socket, VL2E, AT3-III E, AT3-IIS, AT3-IIS32, AT16DI/AT32DI
P1 - P2	No connection (PC3)
PE(mains) - P1	Permanent connection
PE(TS) - P1	Test socket
LN(TS) - P1//PE(TS)	Test socket, VL2E, AT3-III E, AT3-IIS, AT3-IIS32, AT16DI/AT32DI
IPE	
Direct	Test socket, AT16DI/AT32DI (direct or diff.)
Differential	Test socket
Alternative	Test socket, VL2E, AT3-III E, AT3-IIS, AT3-IIS32, AT16DI/AT32DI
AT3 adapter	AT3-III E, AT3-IIS, AT3-IIS32
Clamp	Permanent connection
IB	
Direct	Test socket, AT3-III E, AT3-IIS, AT3-IIS32, AT16DI/AT32DI
Differential	Test socket
Alternative (P1)	Test socket, AT3-III E, AT3-IIS, AT3-IIS32, AT16DI/AT32DI, VL2E
Perm. connection	Permanent connection
Alternative (P1–P2)	No connection (PC3)
IG	
Direct	Test socket, AT16DI/AT32DI (only diff. is sensible)
Differential	Test socket
Alternative	Test socket, AT16DI/AT32DI
AT3 adapter	AT3-III E, AT3-IIS, AT3-IIS32
Clamp	Permanent connection
IA	
Direct (P1)	Test socket
Alternative (P1)	Test socket
Perm. con. (P1)	Permanent connection
IP	
Direct (P1)	Test socket
Perm. con. (P1)	Permanent connection
U probe	
PE - P1	Permanent connection
PE - P1 (with mains)	Test socket
U meas.	
V – COM	Permanent connection
V – COM (with mains)	Test socket
tA	
Mains to test socket	Test socket
P	
Function test	Test socket, AT3-III E, AT3-IIS, AT3-IIS32, AT16DI/AT32DI, CEE adapter
EL1	
EL1 adapter	EL1 and test socket
AT3-III E adapter	AT3-III E
VL2E adapter	VL2E

12 Characteristic Values

Function	Measured Quantity	Display Range / Nominal Range of Use	Resolution	Nominal Voltage U_N	Open-Circuit Voltage U_0	Nom. Current I_N	Short-Circuit Current I_K	Int. Resistance R_I	Ref. Resistance R_{REF}	Measuring Uncertainty ¹	Intrinsic Error ¹	Overload Capacity	
												Value	Time
Tests, 62638 (DIN VDE 0701-0702) / IEC 62353 (VDE 0751)	Protective conductor resistance RPE	1 ... 999 m Ω	1 m Ω	—	< 24 V AC or DC	—	> 200 mA AC / DC > 10 A AC ₅	—	—	$\pm(15\% \text{ rdg.} + 10 \text{ d})$ > 10 d > 10.0 Ω : $\pm(10\% \text{ rdg.} + 10 \text{ d})$	$\pm(10\% \text{ rdg.} + 10 \text{ d})$ > 10 d	264 V 250 mA <hr/> 16 A ⁵	Cont.
		1.00 ... 9.99 Ω	10 m Ω										
		10.0 ... 30.0 Ω	100 m Ω										
	Insulation resistance ⁹ Riso	10 ... 999 k Ω	1 k Ω	50 ... 500 V DC	$1.0 \cdot U_N \dots$ $1.5 \cdot U_N$	> 1 mA	< 2 mA	—	—	$\pm(5\% \text{ rdg.} + 4 \text{ d})$ > 10 d $\geq 20 \text{ M}\Omega$: $\pm(10\% \text{ rdg.} + 8 \text{ d})$	$\pm(2.5\% \text{ rdg.} + 2 \text{ d})$ > 10 d $\geq 20 \text{ M}\Omega$: $\pm(5\% \text{ rdg.} + 4 \text{ d})$	264 V	Cont.
		1.00 ... 9.99 M Ω	100 k Ω										
		10.0 ... 300 M Ω	1 M Ω										
	Leakage current alternative measurement ² IPE, IB, IG, IA	0.0 ... 99 μ A	1 μ A	—	50 ... 250 V~ -20/+10%	—	< 1.5 mA	> 150 k Ω	1 k Ω $\pm 10 \Omega$	$\pm(5\% \text{ rdg.} + 4 \text{ d})$ > 10 d > 15 mA: $\pm(10\% \text{ rdg.} + 8 \text{ d})$	$\pm(2\% \text{ rdg.} + 2 \text{ d})$ > 10 d > 15 mA: $\pm(5\% \text{ rdg.} + 4 \text{ d})$	264 V	Cont.
		100 ... 999 μ A	1 μ A										
		1.00 ... 9.99 mA	10 μ A										
		10.0 ... 30.0 mA	100 μ A										
	Leakage current direct measurement ³ IPE, IB, IG, IA, IP	Only Ip: 0.0 ... 99.9 μ A	100 nA	—	—	—	—	—	1 k Ω $\pm 10 \Omega$	$\pm(5\% \text{ rdg.} + 4 \text{ d})$ > 10 d	$\pm(2.5\% \text{ rdg.} + 2 \text{ d})$ > 10 d	264 V	Cont.
		0.0 ... 99 μ A	1 μ A										
		100 ... 999 μ A	1 μ A										
		1.00 ... 9.99 mA	10 μ A										
	Leakage current differential current measurement ⁴ IPE, IB, IG	0 ... 99 μ A	1 μ A	—	—	—	—	—	1 k Ω $\pm 10 \Omega$	$\pm(5\% \text{ rdg.} + 4 \text{ d})$ > 10 d	$\pm(2.5\% \text{ rdg.} + 2 \text{ d})$ > 10 d	264 V	Cont.
100 ... 999 μ A		1 μ A											
1.00 ... 9.99 mA		10 μ A											
10.0 ... 30.0 mA		100 μ A											
Function test	Line voltage U_{L-N} ¹⁰	100.0 ... 240.0 V~	0.1 V	—	—	—	—	—	—	—	$\pm(2\% \text{ rdg.} + 2 \text{ d})$	264 V	Cont.
	Load current I_L	0 ... 16.00 A _{RMS}	10 mA	—	—	—	—	—	—	—	$\pm(2\% \text{ rdg.} + 2 \text{ d})$	16 A	Cont.
	Active power P	0 ... 3700 W	1 W	—	—	—	—	—	—	—	$\pm(5\% \text{ rdg.} + 10 \text{ d})$ > 20 d	264 V 20 A	Cont. 10 min
	Apparent power S	0 ... 4000 VA	1 VA	Calculated value, $U_{L-N} \cdot I_V$							$\pm(5\% \text{ rdg.} + 10 \text{ d})$ > 20 d		
	Power factor PF with sinusoidal waveform: $\cos\varphi$	0.00 ... 1.00	0.01	Calculated value, P / S, display > 10 W							$\pm(10\% \text{ rdg.} + 5 \text{ d})$		
Voltage Measurement	Probe voltage (probe P1 to PE) $\overline{\sim}$, \sim and $\overline{\sim}$	0.0 ... 99.9 V	100 mV	—	—	—	—	3 M Ω	—	—	$\pm(2\% \text{ rdg.} + 2 \text{ d})$	300 V $\overline{\sim}$, \sim and $\overline{\sim}$	Cont.
	Measuring voltage (V-COM sockets) $\overline{\sim}$, \sim and $\overline{\sim}$		1 V					1 M Ω			$\pm(2\% \text{ rdg.} + 2 \text{ d})$ > 45 Hz ... 65 Hz $\pm(2\% \text{ rdg.} + 5 \text{ d})$ > 65 Hz ... 10 kHz $\pm(5\% \text{ rdg.} + 5 \text{ d})$ > 10 kHz ... 20 kHz		
t_A PRCD	Time to trip	0.1 ... 999 ms	0.1 ms	—	—	30 mA	—	—	—	$\pm 5 \text{ ms}$			
$I_{Leakage}$	Leakage current via AT3-IIIIE adapter Z745S ^{6 8}	0.00 ... 0.99 mA \sim	0.01 mA	—	—	—	—	—	—	—	$\pm(2\% \text{ rdg.} + 2 \text{ d})$ > 10 d without adapter	253 V	Cont.
		1.0 ... 9.9 mA \sim	0.1 mA										
		10 ... 20 mA \sim	1 mA										
Temp	Temperature with Pt100	-200.0 ... +850.0 °C	0.1 °C	—	< 20 V~	—	1.1 mA	—	—	—	$\pm(2\% \text{ rdg.} + 1 \text{ }^\circ\text{C})$	10 V	Cont.
	Temperature with Pt1000	-150.0 ... +850.0 °C											

Function	Measured Quantity	Display Range / Nominal Range of Use	Resolution	Nominal Voltage U_N	Open-Circuit Voltage U_0	Nom. Current I_N	Short-Circuit Current I_K	Int. Resistance R_I	Ref. Resistance R_{REF}	Measuring Uncertainty ¹	Intrinsic Error ¹	Overload Capacity	
												Value	Time
I_{Clamp}	Current via current clamp sensor 1 mV : 1 mA] (V-COM sockets ^{6 7})	1 ... 99 mA ~	1 mA (1 mV)	—	—	—	—	—	—	—	$\pm(2\% \text{ rdg.} + 2 \text{ d})$ > 10 d 20 Hz ... 20 kHz without clamp	253 V	Cont.
		0.1 ... 0.99 A ~	0.01 A (10 mV)										
		1.0 ... 9.9 A ~	0.1 A (100 mV)										
		10 ... 300 A ~	1 A (1 V)										
	Current via current clamp sensor [10 mV : 1 mA] (V-COM sockets ^{6 7})	0.1 ... 9.9 mA ~	0.1 mA (1 mV)	—	—	—	—	—	—	—	$\pm(2\% \text{ rdg.} + 2 \text{ d})$ > 10 d 20 Hz ... 20 kHz without clamp	253 V	Cont.
		10 ... 99 mA ~	1 mA (10 mV)										
		0.10 ... 0.99 A ~	0.01 A (100 mV)										
		1.0 ... 30.0 A ~	0.1 A (1 V)										
	Current via current clamp sensor [100 mV : 1 mA] (V-COM sockets ^{6 7})	0.01 ... 0.99 mA ~	0.01 mA (1 mV)	—	—	—	—	—	—	—	$\pm(2\% \text{ rdg.} + 2 \text{ d})$ > 10 d 20 Hz ... 20 kHz without clamp	253 V	Cont.
		1.0 ... 9.9 mA ~	0.1 mA (10 mV)										
		10 ... 99 mA ~	1 mA (100 mV)										
		0.10 ... 3.00 A ~	0.01 A (1 V)										
	Current via current clamp sensor [1000 mV : 1 mA] (V-COM sockets ^{6 7})	1 ... 99 μ A ~	1 μ A (1 mV)	—	—	—	—	—	—	—	$\pm(2\% \text{ rdg.} + 2 \text{ d})$ > 10 d 20 Hz ... 20 kHz without clamp	253 V	Cont.
		0.10 ... 0.99 mA ~	0.01 mA (10 mV)										
		1.0 ... 9.9 mA ~	0.1 mA (100 mV)										
		10 ... 300 mA ~	1 mA (1 V)										

- ¹ Specified values are only valid for the display at the test instrument. Data transmitted via the USB port may deviate from these values.
- ² Known as equivalent leakage current or equivalent patient leakage current from previous standards
- ³ Protective conductor current, touch current, device leakage current, patient leakage current
- ⁴ Protective conductor current, touch current, device leakage current
- ⁵ Only with **SECUTEST BASE10** (feature G01), **SECUTEST PRO** or **SECULIFE ST BASE**
- ⁶ Only with **SECUTEST PRO** (feature IO1) or **SECULIFE ST BASE**
- ⁷ Measurement types IPE_clamp and IG_clamp
- ⁸ Measurement type IPE_AT3 adapter and IG_AT3 adapter
- ⁹ The upper range limit depends on the selected test voltage.
- ¹⁰ Due to inrush current limiting components, the voltage at the test socket may be lower than the measured line voltage.

Key: rdg. = reading (measured value), d = digit(s)

Test Times, Automated Sequence

Test times ("measurement duration" parameter) can be set separately for each rotary switch position during configuration of the sequence parameters. Test times are neither tested nor calibrated.

Emergency Shutdown During Leakage Current Measurement

As of 10 mA of differential current (can also be set to 30 mA), automatic shutdown ensues within 100 ms. This shutdown does not take place during leakage current measurement with current clamp sensor or adapter.

Influencing Quantities and Influence Error

Influencing Quantity / Sphere of Influence	Designation per DIN VDE 0404	Influence error $\pm \dots\%$ rdg.
Change of position	E1	—
Change to test equipment supply voltage	E2	2.5
Temperature fluctuation	E3	Specified influence error valid starting with temperature changes as of 10 K:
		0 ... 40 °C
Amount of current at DUT	E4	2.5
Low frequency magnetic fields	E5	2.5
DUT impedance	E6	2.5
Capacitance during insulation measurement	E7	2.5
Waveform of measured current	E8	2 with capacitive load (for equivalent leakage current) 1 (for touch current) 2.5 for all other measuring ranges
49 ... 51 Hz		
45 ... 100 Hz		

Reference Ranges

Line voltage	230 V AC $\pm 0.2\%$
Line frequency	50 Hz ± 2 Hz
Waveform	
Sine (deviation between effective and rectified value < 0.5%)	
Ambient temperature	+23 °C ± 2 K
Relative humidity	40 ... 60%
Load resistance	Linear

Nominal Ranges of Use

Nominal line voltage	100 V ... 240 V AC
Nom. line frequency	50 Hz ... 400 Hz
Line voltage waveform	Sinusoidal
Temperature	0 °C ... + 50 °C

Ambient Conditions

Storage temperature	- 20 °C ... + 60 °C
Operating temperature	- 5 °C ... + 40 °C
Accuracy range	0 °C ... + 40 °C
Relative humidity	Max. 75%, no condensation allowed
Elevation	Max. 2000 m
Deployment	Indoors, except within specified ambient conditions

Power Supply

Supply network	TN, TT or IT
Line voltage	100 V ... 240 V AC
Line frequency	50 Hz ... 400 Hz
Power consumption	200 mA test: approx. 32 VA 10 A test: approx. 105 VA

Mains to test socket (e. g. function test)	Continuous max. 3600 VA, power is conducted through the instrument only, switching capacity: ≤ 16 A, ohmic load for currents > 16 A AC please use the adapter AT3-IIS32 (Z745X)
--	--

Electrical Safety

Protection class	1 per IEC 61010-1/DIN EN 61010-1/VDE 0411-1
Nominal voltage	230 V
Test voltage	2.3 kV AC 50 Hz or 3.3 kV DC (mains circuit / test socket to mains PE terminal, USB, finger contact, test probe P1, test socket)
Measuring category	250 V CAT II
Pollution degree	2
Safety shutdown	At DUT differential current of > 10 mA, shutdown time: < 100 ms, can also be set to > 30 mA with following probe current during: – Leakage current meas.: > 10 mA~/< 5 ms – Protective conductor resistance meas.: > 250 mA~/< 1 ms
Fuse links	Mains fuses: 2 ea. FF500 V/16 A Probe fuse: M250 V/250 mA SECUTEST BASE10/PRO SECULIFE ST BASE: one additional FF500 V/16 A FF

Electromagnetic Compatibility

Product Standard DIN EN 61326-1

Interference emission		Class
EN 55011		B
Interference immunity	Test Value	Evaluation criterion
EN 61000-4-2	Contact/atmos. – 4 kV/8 kV	A
EN 61000-4-3	3 V/m or 1 V/m	A
EN 61000-4-4	1 kV	B
EN 61000-4-5	1 kV or 2 kV	A
EN 61000-4-6	3 V/m	A
EN 61000-4-11	0.5/1/25 periods	A
	250 periods	C

USB Data Interface

Type	USB slave for connection to a PC
Type	2 ea. USB master, for data entry devices* with HID-Boot interface, for USB flash drive for data backup, for USB flash drive for saving reports as BMP files for printers*

* compatible devices see section 14

As of firmware version 1.6.0: In the remote operating mode, the test instrument can be controlled via the USB slave data interface. Pertinent interface commands are available upon request.

Bluetooth® 2.1 + EDR Data Interface (feature M01)

Type	for remote control
------	--------------------

Mechanical Design

Display	4.3" multi-display (9.7 x 5.5 cm), backlit, 480 x 272 pixels at 24 bit color depth (true color)
Dimensions	W x H x D: 295 x 145 x 150 mm Height with handle: 170 mm
Weight	Approx. 2.5 kg
Protection	Housing: IP 40 Test socket: IP 20 per DIN VDE 0470, part 1/EN 60529

Table Excerpt Regarding Significance of IP Codes

IP XY (1 st digit X)	Protection Against Foreign Object Ingress	IP XY (2 nd digit Y)	Protection Against Penetration by Water
2	≥ 12.5 mm dia.	0	Not protected
4	≥ 1.0 mm dia.	0	Not protected

SECULIFE ST BASE: Housing with antimicrobial properties in accordance with the JIS-Standard Z 2801:2000

13 Maintenance

13.1 Housing Maintenance

No special maintenance is required for the housing. Keep outside surfaces clean. Use a slightly dampened cloth for cleaning. Avoid the use of cleansers, abrasives or solvents.

13.2 Testing the Color Display and the Buzzer (self-test parameter)

The color display can be tested for failure of individual segments and loss of color components on page 3/3 of the setup menu in the SETUP switch position under the self-test parameter.

Beyond this, the buzzer can be tested for 3 different frequencies.

13.3 Software Update (system info parameter)

The current firmware or software version can be queried via the system info parameter (setup 3/3).

The test instrument's firmware can be updated via the USB port with the help of a PC. Updating is only possible via the proprietary "Firmware Update Tool" application, which is integrated into the firmware.



Attention!

Before updating the firmware, it is imperative that you save the structures you have created and your measuring data as they might be deleted in the process, see section 5.4.4, "Backing Up and Restoring the Database".



Note

Adjustment data are not overwritten during updating. Recalibration is therefore not necessary.

The most up-to-date version of the software (firmware) can be downloaded from the **mygmc** page of our website as a ZIP file, if you have registered your test instrument:

<http://www.gossenmetrawatt.com>
→ Products → Software → Software for Testers → Utilities → **SECUTEST4 Update**

Operating instructions for the **Firmware Update Tool** are also available there.



Attention!

The interface cable may not be disconnected while updating the firmware via the USB port.



Attention!

The test instrument may not be disconnected from supply power while updating the firmware via the USB port.

13.4 Backup Battery for Real-Time Clock

The backup battery (lithium cell) should be replaced no later than after 8 years. Replacement can only be executed by the service department.

If backup battery voltage is too low, the date and time assigned to the test data no longer correspond to the actual time of recording. This may also influence sorting in ETC report generating software.

The instrument's database itself is not affected by a depleted backup battery.

13.5 Fuse Replacement

The fuses may only be replaced when the instrument is voltage-free, i.e. the instrument must be disconnected from mains supply power and may not be connected to a measuring circuit.

The fuse type must comply with the specifications in the technical data or the labeling on the instrument.

13.6 Recalibration

The measuring tasks performed with your instrument, and the stressing it's subjected to, influence aging of its components and may result in deviation from the specified levels of accuracy.

In the case of strict measuring accuracy requirements, as well as in the event of use at construction sites with frequent stress due to transport and considerable temperature fluctuation, we recommend a relatively short calibration interval of once per year. If your instrument is used primarily in the laboratory and indoors without considerable climatic or mechanical stressing, a calibration interval of once every 2 to 3 years is sufficient as a rule.

During recalibration* at an accredited calibration laboratory (DIN EN ISO/IEC 17025), deviations from traceable standards demonstrated by your measuring instrument are documented. Ascertained deviations are used to correct display values during later use of the instrument.

We would be happy to perform DAKKS or factory calibration for you at our calibration laboratory. Further information is available at our website:

www.gossenmetrawatt.com (→ Company → DAKKS Calibration Center or → FAQs → Questions and Answers Regarding Calibration).

According to DIN VDE 0701-0702, only test instruments which are tested and calibrated at regular intervals may be used for testing.

Recalibration of your instrument at regular intervals is essential for the fulfillment of requirements according to quality management systems per DIN EN ISO 9001.

* Examination of the specification, as well as adjustment, are not included in calibration. However, in the case of our own products, any required adjustment is performed and adherence to the specification is confirmed.

13.7 Technical Safety Inspections

Subject your test instrument to technical safety inspections at regular intervals. We recommend the same interval for inspections as is also used for recalibration.

The SECUTEST... is designed as a totally insulated device in accordance with IEC 61010 and IEC 61557-16/VDE 0413-16. The protective conductor is used for measuring purposes only, and is thus not always accessible. The protective conductor at the test socket can be tested as follows:

- ⇨ Connect the SECUTEST... to a multiple distributor.
- ⇨ Conduct a touch current measurement for permanently connected DUTs (nothing may be connected to the test socket).
- ⇨ Measure protective conductor resistance between the neighboring socket at the multiple distributor and the test socket.
- ⇨ The measured value may not exceed 0.3 Ω.

For technical reasons, insulation resistance between LN and PE inside the SECUTEST... is roughly 3 MΩ.

This must be taken into consideration during technical safety inspections or, instead of the insulation resistance measurement, the protective conductor current measurement must result in a value of less than 3.5 mA (or less than 7 mA if the equivalent leakage current method is used).

There are also 4 accessible conductive parts on the SECUTEST..., at which the touch current measurement must result in a value of less than 0.5 mA:

- Connector for service plug (jack socket)
- USB ports
- Metallized start key
- Protective conductor bar in the test socket



Note

In order to prevent damage to the SECUTEST... test instrument, we recommend avoiding the performance of measurements at the USB ports.

13.8 Returns and Environmentally Sound Disposal

The instrument is a category 9 product (monitoring and control instrument) in accordance with ElektroG (German electrical and electronic device law). This device is subject to the RoHS directive. Furthermore, we make reference to the fact that the current status in this regard can be accessed on the Internet at www.gossenmetrawatt.com by entering the search term WEEE.

We identify our electrical and electronic devices in accordance with WEEE 2012/19/EU and ElektroG using the symbol shown at the right per DIN EN 50419.



These devices may not be disposed of with the trash.

Please contact our service department regarding the return of old devices (see address in Section 15).

14 Appendix

The following devices have been tested for use with the test instrument. We are unable to offer any guarantees regarding use with other devices.

14.1 List of Suitable Printers with USB connection

- **Z721S thermal printer**
- **Z721D barcode printer** (as of firmware V1.3.0)
Setup options in the SETUP switch position
(Setup (2/3) > Printer > Z721D > Printer settings):
Paper size: 6 mm, 9 mm, 12 mm, 18 mm, 24 mm, 36 mm
Coding: Code 39, Code 128, EAN13

14.2 List of Suitable Barcode Scanners and RFID Scanners with USB connection

- Z751A barcode scanner
- Z751E RFID scanner (programmer)

14.3 Application of USB Storage Devices

For various device functions (see section 3.8 and 5.2) USB flash drives must be directly connected to the test instrument.

The connected USB storage medium must fulfill at least the following requirements in order to be applied with your test instrument:

- The file system on the USB flash drive is formatted for FAT (FAT16/FAT32). NTFS or exFAT file systems are not compatible, for example.
- Maximum power consumption of the USB storage medium via the USB port may not exceed 500 mA.
- Do not use any USB storage devices with encoding functions.

Furthermore, you should ensure that the USB drive features an LED display which indicates whether a write operation has already been completed.

List of tested and approved USB flash drives:

- Philips USB flash drive Snow Edition USB 3.0
(tested size: 64 GB)
- Toshiba TransMemory-MX U361 USB 3.0
(tested size: 64 GB)
- Corsair Flash Voyager Vega USB 3.0
(tested size: 16 GB)
- SanDisk Cruzer Glide USB 2.0/3.0
(tested size: 64 GB)

14.4 Bluetooth Interface (Feature M01)

The Bluetooth interface can be used for remote controlling the test instrument provided that the associated protocol is known. Barcode scanners with Bluetooth interface are in preparation.

Setup 3/3

Menu Selection for Operating Parameters Page 3 of 3

Bluetooth: menus for operating the Bluetooth interface

Menu Selection for Operating Parameters Bluetooth

Status: Activate/deactivate Bluetooth interface

Device couplings*: Search / couple BT devices, visualize/process existing couplings

Device name*: The name of the test instrument displayed above the interface can be modified here.

Visibility*: Defines whether the test instrument can be found by other Bluetooth devices.

* these sub-menus only appear if status is set to ON.

Menu Selection for Operating Parameters Bluetooth

Search for Bluetooth devices in proximity

Coupled device found (white frame) > rename or delete

Not yet coupled device found (blue frame) > entry of pairing PIN

Important Notes

- **Status/visibility:** For reasons of safety, we recommend deactivating the Bluetooth interface if it is not required. The setting „not visible“ does not make deactivation of the Bluetooth interface redundant as invisible Bluetooth devices can actually be localized with the appropriate means.
- **Device couplings** which are not required for an extended period of time should be deleted.
- The **device name** of the DUT has been set at SECUTEST by default. If you access one PC with several test instruments, we advise you to supplement the name to facilitate assignment: SECUTEST1, SECUTEST2, etc.

14.5 Index

Numerics

2nd Test Probe	2, 19
2-Pole Measurement (P1-P2)	19

A

Access (last) Measured Values	
Database Function	17
Single Measurements	22

Auto Measuring Point	52
----------------------------	----

B

Backup Battery	71
----------------------	----

Barcode Scanner	
Configuration	7
Connection	7
List	72

Barcodes	
Print-Out	8
Read-In	7

C

Calibration data	11
------------------------	----

Changing the language	7, 11
-----------------------------	-------

Classification Parameter	53
--------------------------------	----

Connection	
Device Under Test	18
Prompts	19
Test Probe P1 or P2	9
Tests	19

Connections	
Overview	2

Continuous Measurement	
Icon	52

Controls	2
----------------	---

D

Detection of Probes / Measurement Cables	19
--	----

Dual-Lead Measurement (P1-P2)	19
-------------------------------------	----

DUT connection detection	19
--------------------------------	----

E

End of Sequence	52
-----------------------	----

Enter a new, select, delete inspector, protect by password	10
--	----

Equivalent Leakage Current	
Limit Values	40

Error Displays	59
----------------------	----

Error Messages	60
----------------------	----

F

Firmware Update Tool	71
----------------------------	----

Fuses	
Characteristic Values	70
Location	2
Replacement	5, 71

I

Included Features	3
-------------------------	---

Initial Window	
Style	52

Insulation Resistance	
Limit Values	30

IT Systems	9
------------------	---

K

Keyboard Layout	7, 15
-----------------------	-------

L

Language	7
----------------	---

Limit Value Mode	52
------------------------	----

M

Mains Connection	
Errors	9
Plug	8

Maintenance	71
-------------------	----

Measuring Sequence	
With Pre-Selection of the DUT	22
with Subsequent Entry of the DUT	22

Measuring Sequences	
Standard Selection	52

Measuring Uncertainty	52
-----------------------------	----

Multiprint	7
------------------	---

O

Offset Values	25
---------------------	----

On Test	19
---------------	----

Overview	
Controls	2
Included Features	3

P

Patient Leakage Current	
Limit Values	43

PRCD	24, 46
------------	--------

PRCD Typ	54
----------------	----

Protection Class Detection	19
----------------------------------	----

Protective Conductor Resistance	5
---------------------------------------	---

R

Real-Time Clock	71
-----------------------	----

Recalibration	71
---------------------	----

Reference Voltage L-PE	18
------------------------------	----

Report Designer	7
-----------------------	---

Residual Current Monitoring	18
-----------------------------------	----

RESTORE	17
---------------	----

Restoring	17
-----------------	----

Returns	72
---------------	----

RFID Scanner	
List	72

RFID Tags	
Read	7
Write	8

RoHS Directive	72
----------------------	----

S

Safety Precautions	5
--------------------------	---

Scope of Delivery	3
-------------------------	---

SECUTEST CLIP	25, 31, 33, 40
---------------------	----------------

Self-Test	71
-----------------	----

Sequence Designer	51
-------------------------	----

Sequence Parameter	55
--------------------------	----

Short-Circuit Test	19
--------------------------	----

Software	
Update	71
Version	2, 10

Switching Power Consumers – Course of action	6
--	---

Switching Power Consumers – Maximum Starting current	6
--	---

Symbols	
Object Creation	16
on the Device	6
User Interface	
Database Management	15
Single Measurements	22
Test Sequence	52

Table of Single Measurements	5
------------------------------------	---

Technical Safety Inspections	71
------------------------------------	----

Touch Current	19
---------------------	----

Touch-screen	15
--------------------	----

U

USB Flash Drive	
Database Backup	13
Export ETC File	13
Import ETC File	13
Restoring a Database	13
Saving Reports	8

USB keyboard	15
--------------------	----

V

Voltage Measuring Inputs	2
--------------------------------	---

WZ12C	25, 33, 40
-------------	------------

15 Repair and Replacement Parts Service Calibration Center* and Rental Instrument Service

If required please contact:

GMC-I Service GmbH
Service Center
Thomas-Mann-Str. 16 - 20
90471 Nuremberg, Germany
Phone: +49-911-817718-0
Fax: +49-911-817718-253
e-mail: service@gossenmetrawatt.com
www.gmci-service.com

This address is only valid in Germany. Please contact our representatives or subsidiaries for service in other countries.

* DAkkS calibration laboratory for electrical quantities, registration no. D-K-15080-01-01, accredited per DIN EN ISO/IEC 17025
Accredited quantities: direct voltage, direct current value, direct current resistance, alternating voltage, alternating current value, AC active power, AC apparent power, DC power, capacitance, frequency and temperature

Competent Partner

GMC-I Messtechnik GmbH is certified per DIN EN ISO 9001.

Our DAkkS calibration laboratory is accredited by the Deutsche Akkreditierungsstelle GmbH (national accreditation body for the Federal Republic of Germany) under registration number D-K-15080-01-01 in accordance with DIN EN ISO/IEC 17025.

We offer a complete range of expertise in the field of metrology: from test reports and factory calibration certificates right on up to DAkkS calibration certificates. Our spectrum of offerings is rounded out with free test equipment management.

An on-site DAkkS calibration station is an integral part of our service department. If errors are discovered during calibration, our specialized personnel are capable of completing repairs using original replacement parts.

As a full service calibration laboratory, we can calibrate instruments from other manufacturers as well.

16 Product Support

If required please contact:

GMC-I Messtechnik GmbH
Product Support Hotline
Phone: +49-911-8602-0
Fax: +49 911 8602-709
e-mail: support@gossenmetrawatt.com

Edited in Germany • Subject to change without notice • PDF version available on the Internet

 **GOSSEN METRAWATT**

GMC-I Messtechnik GmbH
Südwestpark 15
90449 Nürnberg, Germany

Phone: +49-911-8602-111
Fax: +49 911 8602-777
e-mail: info@gossenmetrawatt.com
www.gossenmetrawatt.com